

• SERVICE •  
PARTS LIST



PACKARD



# PACKARD Service Parts List

## Packard Twelve

905-906

1005-1006

1107-1108

1207-1208

1407-1408

Issued November, 1935

Copyrighted 1935

PACKARD MOTOR CAR COMPANY  
DETROIT, MICHIGAN, U. S. A.



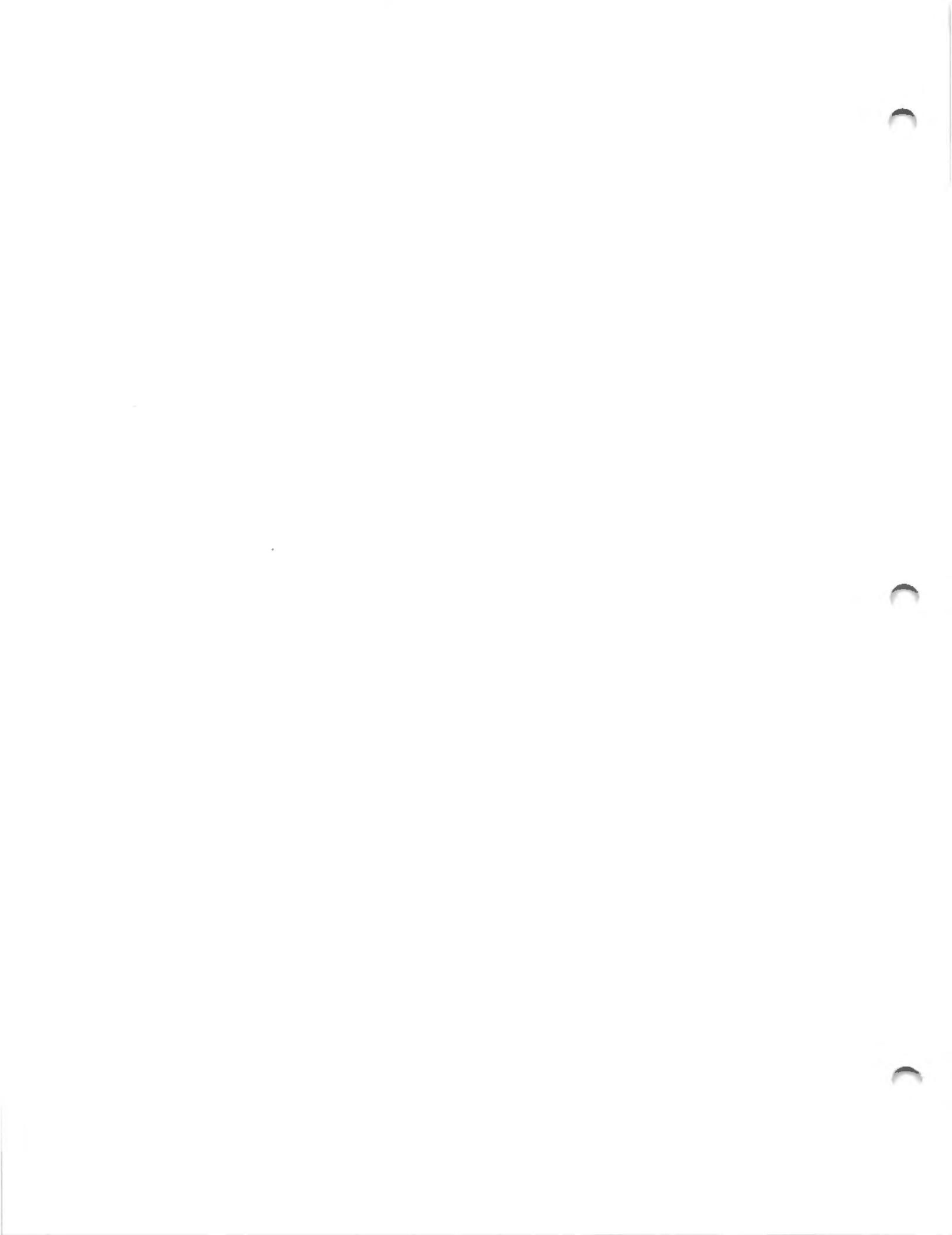



## TO PACKARD DISTRIBUTERS

In compiling this parts list we have endeavored to arrange in the most convenient manner, necessary data for ordering repair parts.

The text is indexed both alphabetically and numerically, with illustrations distributed so that each cut is in close relation to its text. Wiring diagrams are incorporated, which not only show the method of wiring these cars but also list the piece numbers of all units used in the electrical system.

Repair parts for some accessory units are herein listed and illustrated under the manufacturer's own piece number. Distributors should order these from the Packard factory and dealers should order from their distributor, using the manufacturer's piece number when no other number is shown. Customers should not be sent direct to the accessory manufacturer or their local agent for service.

### SERIAL NUMBER LOCATION

Front axle: ..... front side of axle  
Motor: ..... left front side of cylinder block  
Steering: ..... upper face of steering gear housing  
Frame: ..... upper face of left hand side member  
          just forward of dash  
Clutch and transmission: right rear end of case  
Rear Axle: ..... left lower side of differential  
          carrier flange  
Vehicle number: ..... stamped on the plate, fastened to  
          front face of dash

### MOTOR NUMBER

905- 906 - 900,001 to 901,000  
1005-1006 - 901,001 to 901,600  
1107-1108 - 901,601 to 903,100  
1207-1208 - 903,101 to 904,000  
1407-1408 - 904,001 up ..

### ORDERING PARTS

Use only standard Distributer's Sundry and Part Order forms No. D-19.

Correct "charge to" and "ship to" names and addresses should be shown on every order.

Give piece number, name and quantity required.

Always advise motor or vehicle number.

State definite shipping instructions, i. e., parcel post, express or freight, etc.

Give explicit instructions how cases are to be marked.

Detail ordering instructions as outlined in Technical and Trade Letters should be adhered to in all cases.

In ordering utility parts always specify finish desired.

Many special notes appear after the part names showing some of the parts listed herein being used or not used on certain models or body types and these notes should be watched very carefully when ordering from this book.

SERVICE DEPARTMENT  
PACKARD MOTOR CAR COMPANY  
DETROIT, MICHIGAN  
U. S. A.



### BODY TYPES

905	906	1005	1006	Pass.	Description
570		630		7	Touring
571		631		4	Phaeton
581		641		4	Sport Phaeton
573		633		5	Sedan
583		643		5	Conv. Sedan
		5633		5	Formal Sedan
		5633-A		5	Formal Sedan
	574		634	7	Sedan
	575		635	7	Sedan Limousine
576		636		5	Club Sedan
577		637		5	Coupe
587		647		5	Victoria
578		638		2-4	Coupe
579		639		2-4	Coupe-Roadster
			D-758	7	All-Weather Cabriolet
			D-759	7	All-Weather Town Car

1107	1108	1207	1208	1407	1408	Pass.	Description
730			830		930	7	Touring
731		831		931		5	Phaeton
741		821		921		5	Sport Phaeton
733		833		933		5	Sedan
743			873		973	5	Conv. Sedan
732		832		932		5	Formal Sedan
	734		834		934	7	Sedan
	735		835		935	7	Sedan Limousine
736		836		936		5	Club Sedan
737		837		937		5	Coupe
747		827		927		5	Victoria
738		838		938		2-4	Coupe
739						2-4	Coupe-Roadster
		839		939		2-4	Conv. Coupe
	D-858	L-195		L-194		7	All-Weather Cabriolet
	D-859		L-194		L-195	7	All-Weather Town Car



## GENERAL PART NAME INDEX

Part Name	Page No.	Part Name	Page No.
<b>A</b>			
Accelerator pedal .....	1	Carpets-See Floor carpets ..	223-239-290-342
Accelerator pedal foot rest assembly- See Toe board accelerator pedal foot rest assembly .....	186	Change speed lever-See Transmission change speed lever .....	189
Ammeter-See Instrument board ammeter .	64-69	Change speed lever support Liner-See Toe board change speed lever support liner .....	187
Arm rest-See Arm rest .....	251-257-280-332-383	Choke (Automatic) See Motor carburetor automatic choke .....	84-88-93
Door arm rest .....	282-334-385	Choke parts (Automatic) .....	88-93
Folding arm rest .....	223-239-290-343	Cigar lighter-See Instrument board cigar lighter ..	64-69
Arm sling .....	258-280	Smoking case cigar lighter .....	269-305-354-396
Auto jack-See Tool box auto jack .....	187	Arm rest cigar lighter ....	251-332-384
Automatic choke-See Motor carburetor automatic choke assembly .....	84-88-93	Clock-See Instrument board clock .	65-69-332
Automatic choke parts .....	88-93	Clock-See Smoking case clock .....	269
Automatic starter switch .....	176	Clutch .....	22
<b>B</b>			
Backing light switch-See transmission backing light switch .....	189	Clutch control .....	28
Battery-See Electrical battery .....	40	Clutch shaft-See Transmission clutch shaft .....	189
Battery Box .....	2	Clutch shaft bearing front-See Motor clutch shaft bearing front .....	95
Battery supports-See Frame battery support .....	53	Clutch shifter lever-See Transmission clutch shifter lever .....	191
Body attaching parts .....	209-219-235-251-257-279-331-383	Clutch vacuum cylinder bleeder valve body-See Transmission clutch vacuum cylinder bleeder valve body .....	192
Body to frame bolts .....	209-219-235-251-257-279-331-383	Connecting rod-See Motor connecting rod .	95
Body to frame liners .....	209-219-235-251-257-279-331-383	Connecting rod-See Steering connecting rod .....	178
Bonnet .....	3-6	Courtesy lamp-See Lamp courtesy .....	76
Bonnet dash liner ..	209-219-235-258-281-333	Cowl-See Panel cowl assembly .	212-224-243-266-299-351-393
Brake .....	7-13	Tonneau cowl .....	213-227-243-254
Brake drum-See wheel hub and drum .....	203	Crankcase-See Motor crankcase .....	97
Brake pedal shaft-See Clutch and brake pedal shaft .....	22	Crankshaft-See Motor crankshaft .....	97
Brake shoes and lining .....	11-16	Curtain rollers-See Window curtain rollers .....	272-316-367-401
Brake vacuum control valve lever- See Instrument board brake vacuum control valve lever .....	64	Cylinder and Pistons-See Motor cylinder and pistons .....	98
Bumper .....	19-20	<b>D</b>	
Bumper and Stabilizer chart .....	21	Dash panel-See Panel Dash .....	212-224-243-266-299-351-393
Buzzer .....	333	Dictograph-Also see Electrical dictograph .....	258-281-333
<b>C</b>			
Cables-Also see Electrical wiring assembly .....	30-34-43	Differential bearing-See Rear axle differential bearing .....	150-152
Cable insulator-See Electrical cable terminal insulator .....	30-34-43	Differential carrier-See Rear axle differential carrier .....	150-152
Cable terminal-See Electrical cable terminal .....	30-34-43	Differential case-See Rear axle differential case .....	151-153
Camshaft-See Motor camshaft .....	83	Differential driving gear and pinion- See Rear axle differential driving gear and pinion .....	151-153
Carburetor-See Motor carburetor ...	84-89-93	Differential driving pinion universal joint flange-See Rear axle differen- tial driving pinion universal joint flange .....	153
Carburetor throttle valve connecting rod- See Accelerator pedal shaft lever to carburetor throttle valve connecting rod .....	1		

## GENERAL PART NAME INDEX

Part Name	Page No.	Part Name	Page No.
D - Continued		G	
Distributor-See Motor distributor .....	101	Gasoline fuel pump inlet hose assembly	57-59
Dome light-Also see Electrical dome		Gasoline gauge-See Instrument board	
light .....	258-281-333	gasoline or oil gauge .....	66-70
Doors .....	210-219-235-259-282-334-384	Gasoline tank .....	57-59
Door arm rest .....	282-385	Gasoline tank gauge .....	57-59
Door parts . 210-220-235-251-259-282-334-385		Gear cover-See Motor gear cover .....	114
Door finishing mouldings-See moulding		Generator-See Motor Generator .....	115
door window finishing ....	264-296-348-392	Golf compartment .....	263-295-347-392
Door panels-See Panel door		Grip handle .....	263
.....	212-224-243-251-266-299-351-393		
Door trim panel-See Moulding-		H	
door trim panel .....	254	Hand brake lever-See Brake lever and	
Drip plugs-See Lubricator drip plug .....	79	bushing assembly .....	9-13
E		Hand brake lever cutout cover	
Electrical .....	30-32-35-36-387	.....	224-243-295-348
Electrical (Miscellaneous) .....	40	Hassock .....	264-295-348-392
Exhaust manifold-See Motor exhaust		Headlight-See Lamp front .....	72-74-77
manifold .....	125	Horn-See Electrical horn .....	42
Exhaust muffler .....	46	button-See Steering post horn	
Exhaust pipes .....	48	button .....	184
Exhaust valve-See Motor valve exhaust ..	140	Horn relay-See Electrical horn relay ....	42
F		Hub cap-See Wheel hub cap front .....	203
Fan-See Motor fan .....	109	I	
Fan pulley-See Motor water pump shaft		Ignition coil and switch-See Instrument	
impeller and fan pulley .....	142	board ignition coil and switch .....	66
Fasteners .....	210-220-236-261-289-341	Ignition coil and switch parts .....	63
Fenders-front .....	48	Inlet valve-See Motor valve inlet .....	140
Fenders-rear .....	51	Instrument board .....	64-212
Fender lamp-See Lamp fender .....	73-75-76	Instrument board ammeter .....	64-69
Floor board .211-223-239-252-262-289-342-388		Instrument board cigar lighter .....	64-69
Floor carpet .....	223-239-290-342	Instrument board clock .....	65-69
Flywheel-See Motor flywheel .....	109	Instrument board compartment door ....	65-70
Folding arm rest .....	223-239-290-343	Instrument board gasoline or oil gauge	66-70
Folding seat 211-223-240-253-262-291-343-388		Instrument board gasoline or oil gauge	
Foot rest .....	211-224-240-253-291-344-389	switch .....	66-70
Frame .....	53	Instrument board ignition coil and	
Frame rear end splasher-See		switch .....	66-70
Splasher frame rear end .....	170	Instrument board ignition coil parts ....	63
Front axle .....	55	Instrument board light-direct (reading	
Front axle spring-See Spring front .....	174	light) .....	67-71
Front axle spring bracket-See frame		Instrument board light indirect .....	67
spring front bracket .....	54	Instrument board light switch .....	67-71
Front axle spring shackle bracket-See		Instrument board motor thermometer ...	67-72
Frame spring front shackle bracket ....	54	Instrument board oil pressure gauge ..	68-71
Front end chain-See Motor camshaft		Instrument board radio hole cover .....	71
driving chain .....	83	Instrument board speedometer .....	68-72
Front end cover-See Motor gear cover ...	114	Instrument board starter motor switch ...	69
Front seat		Instrument board steering post bracket	
.....	212-224-240-253-263-292-344-389-390	support .....	69
Fuel pump-See Motor fuel pump .....	110	Intake manifold-See Motor intake	
Fuse-See Electrical wiring fuse .....	44	manifold .....	125





## GENERAL PART NAME INDEX

Part Name	Page No	Part Name	Page No.
<b>R - Continued</b>			
Robe rail ..	213-227-243-254-267-301-353-395	Steering post bracket support-See Instrument board steering post bracket support .....	69
Rocker levers-See Motor camshaft rocker lever .....	84	Steering post horn button .....	184
Rumble seat.....	267-301-353-395	Steering post to instrument board bracket and cap .....	184
Running board .....	154-156	Steering post lighting switch control shaft assembly .....	184
Running board to frame splasher-See Splasher side .....	172	Steering post throttle control shaft assembly .....	185
Running board lamp-See Lamp running board .....	74-76	Steering wheel assembly .....	186
<b>S</b>			
Shock absorber .....	158-162	Steering worm .....	186
Shock absorber parts .....	167-169	Stop light switch-See Electrical stop light switch .....	43
Shock absorber front bracket-See Frame shock absorber front bracket ....	55	Stop light bulb-See Lamp rear stop light bulb .....	74-76
Shock absorber relief valves .....	165-166	Stop light cable-See Lamp rear stop light cable .....	74-76-78
Side Wheel carrier .....	205-206	Sun visor .....	272-305-359-396
Smoking case-See Smoking case.....	269-305-354-396	Synchronizer brake and housing- See Transmission synchronizer brake and housing .....	196
Arm rest smoking case .....	251-332-384	<b>T</b>	
Snap fasteners .....	210-220-236-261-289-341	Tail lamp-See Lamp rear .....	73-75-78
Spark plugs-See Motor ignition spark plug .....	125	Thermometer-See Instrument board motor thermometer .....	72
Spark plug wrench-See Tool single head box wrench .....	188	Timing chain-See Motor camshaft driving chain .....	83
Speedometer-See Instrument board speedometer .....	68-72	Tire pump-See Tool box tire pump .....	187
Speedometer pinion and shaft-See Transmission speedometer pinion and shaft .....	195	Toe board .....	186
Splasher .....	169-173	Toggle grip .....	270-305-359-396
Spotlight .....	213-243-254	Tonneau cowl .....	213-227-243-254
Spring-front .....	174	Tonneau light .....	213-227-244-254-270-305-359-397
Spring-rear .....	175	Tonneau ventilator .....	214-228-244
Spring cover-See Chart .....	177	Tools .....	187
Starter motor switch-See Instrument board starter motor switch .....	69	Tool box assembly .....	188
Starter motor and switch-See Motor starter motor and switch .....	133	Tool compartment .....	214-228-244
Starting crank-See Tool motor starting crank .....	187	Top .....	214-228-244-255-270-359-397
Starting crank hole cover assembly- See Radiator shell motor starting crank hole cover assembly .....	146	Transmission .....	189
Starter switch-automatic .....	176	Trimming material .....	216-232-249-275-326-378-408
Steering connecting rod .....	178	Trunk rack .....	196-198-398
Steering cross tube-See Front axle steering cross tube .....	55	Trunk and trunk bars .....	270-311-363
Steering gear .....	178-185	<b>U</b>	
Steering gear lighting switch-See Electrical steering gear lighting switch base and switch term block ....	43	Universal joint .....	199-201
Steering knuckle-See Front axle steering knuckle .....	56	Universal joint flange-See Rear axle differential driving pinion universal joint flange .....	153
Steering pillar tube assembly .....	183	Transmission driving shaft universal joint flange .....	195
Steering post .....	183	<b>V</b>	
		Valve-See Motor valve .....	140

## GENERAL PART NAME INDEX

Part Name	Page No.	Part Name	Page No.
V - Continued			
Valve cover-See Motor valve cover .....	140	Wheel carrier spacer-See Frame	
Valve spring-See Motor valve spring ....	141	wheel carrier spacer .....	55
Vanity case-Arm rest .....	251-332-384	Wheel compartment .....	255-399
Ventilator . 215-229-245-256-271-312-363-399		Wheel puller bolt-See Tool wheel	
Vibration damper-See Motor vibration		puller bolt .....	187
damper .....	141	Wheel puller shell-See Tool wheel	
Visor-See Sun Visor .....	272-305-359-396	puller shell .....	187
W			
Water pump-See Motor water pump .....	141	Window .....	272-316-367-401
Wheels .....	203	Window curtain .....	401
Wheel carrier .....	204	Windshield . 215-229-246-256-273-322-373-406	
		Wiring fuse block-See Electrical	
		wiring fuse block .....	44



## NUMERICAL INDEX

Part No.	Page No.	Part No.	Page No.	Part No.	Page No.	Part No.	Page No.	Part No.	Page No.
19898	13	29651	327	33883	216	62065	251	98316	34
20075	126	29651	379	33883	233	62065	263	98316	115
20075	129	29651	408	33883	249	62065	256	98345	83
20075	150	29652	217	35579	23	62065	270	98386	95
20075	152	29652	233	36111	30	62065	292	98387	95
20075	179	29652	250	36111	31	62065	306	98388	95
20075	189	29652	276	36111	34	62065	344	98389	96
21662	126	29652	328	36111	42	62065	359	98390	96
21662	129	29652	380	36111	67	62065	394	98391	96
21662	130	29657	217	36111	70	62065	399	98648	267
21818	64	29657	233	36111	72	62065	400	100100	211
21964	50	29657	250	36111	209	62065	407	100100	223
21964	156	29657	276	36111	219	62455	175	100100	240
23731	174	29657	329	36111	235	62580	152	100100	253
23731	175	29657	380	36111	258	62759	217	100100	262
29254	209	29662	276	36111	280	62759	233	100100	291
29254	258	29662	329	36111	332	62759	250	100100	343
29254	387	29662	380	36111	401	62759	277	100100	389
29595	275	29663	217	39403	171	62759	329	101199	205
29595	327	29663	233	42123	128	62759	381	101200	66
29595	379	29663	250	43293	56	62759	410	101200	157
29595	408	29663	276	45933	151	64383	174	101200	160
29612	276	29663	329	45933	152	66570	83	101200	164
29618	216	29663	380	46706	188	68073	44	101200	407
29618	232	29664	217	46707	187	68073	58	101808	9
29618	249	29664	233	47669	187	70128	71	101808	14
29625	217	29664	250	48157	66	70296	74	101810	9
29625	233	29664	276	48202	42	70296	76	101810	14
29625	250	29664	311	48202	258	71030	187	102150	223
29625	277	29664	329	48202	280	71397	41	102150	239
29625	329	29664	363	48202	333	76925	211	102507	213
29625	380	29664	380	48317	187	76925	223	102507	227
29625	410	29666	217	48616	42	76925	239	102507	243
29627	217	29666	233	48616	332	76926	211	102507	254
29627	233	29666	250	51331	272	76926	220	102507	255
29627	250	29666	276	51331	318	76926	239	102507	399
29627	277	29666	329	51331	371	77082	155	102585	67
29627	329	29666	380	51331	372	77748	101	102585	258
29627	380	29790	272	51331	373	79005	58	102585	281
29627	410	29790	327	53127	41	79005	60	102585	333
29637	276	29790	379	53326	130	79574	262	102585	387
29637	329	29790	408	53676	127	79574	291	102590	67
29637	380	33170	266	53676	129	79574	389	102590	71
29637	409	33170	275	61577	188	79574	344	102590	73
29638	276	33287	30	62065	2	96529	196	102590	74
29638	329	33287	31	62065	4	97056	56	102590	75
29638	380	33287	34	62065	5	98083	161	102590	76
29638	409	33287	41	62065	6	98123	142	102590	227
29640	217	33287	67	62065	7	98249	203	102590	244
29640	233	33287	70	62065	49	98250	203	102590	254
29640	250	33287	209	62065	50	98251	203	102590	267
29640	276	33287	219	62065	52	98252	203	102590	268
29640	329	33287	235	62065	53	98264	10	102590	270
29640	380	33287	258	62065	149	98267	15	102590	299
29640	409	33287	280	62065	150	98278	95	102590	300
29651	216	33287	300	62065	170	98279	95	102590	301
29651	233	33287	332	62065	172	98289	15	102590	305
29651	249	33287	333	62065	173	98292	15	102590	352
29651	275	33287	352	62065	188	98316	30	102590	353

## NUMERICAL INDEX

Part No.	Page No.	Part No.	Page No.	Part No.	Page No.	Part No.	Page No.	Part No.	Page No.
102590	359	111671	236	114525	263	118555	229	124617	151
102590	388	111671	263	114525	292	118555	245	124617	154
103840	216	111671	295	114525	344	118555	271	124618	151
103871	195	111671	347	114775	158	118555	312	124618	154
105025	216	111672	263	114775	159	118555	364	124631	152
105025	233	111672	295	114775	163	118771	215	124631	154
105025	249	111672	347	114955	56	118771	229	124635	152
105025	276	111687	266	114955	178	118771	245	124715	152
105025	328	111687	299	115023	216	118771	271	125433	56
105025	379	111687	352	115023	233	118771	312	126145	55
105029	65	111687	400	115023	250	118771	364	126148	55
105029	212	111752	145	115023	276	118970	196	126149	55
105029	264	112054	236	115023	328	119143	68	126151	56
105029	393	112054	341	115268	210	119226	210	126495	56
105029	394	112054	411	115268	220	119226	220	126578	31
105029	396	112058	220	115268	232	119226	236	126578	35
105161	60	112058	211	115268	236	119245	210	126578	67
106755	211	112058	236	115268	249	119245	220	126587	8
106755	223	112058	411	115773	188	119245	236	126770	40
106755	239	113789	217	115774	188	119296	210	126828	8
106964	217	113789	233	115781	188	119296	220	126985	180
106964	233	113789	250	115798	210	119296	236	126986	178
106964	250	113789	276	115798	220	119297	210	126986	182
106964	276	113789	329	115798	239	119297	220	127012	180
106964	328	113789	380	115798	261	119297	236	127012	186
106964	380	113812	217	115798	342	119298	210	127039	43
107654	267	113812	233	115798	411	119298	220	127253	328
107654	268	113812	250	115799	210	119298	236	127253	379
107654	299	113812	276	115799	220	119298	259	127253	409
107654	302	113812	328	115799	239	119298	282	127273	151
107654	352	113812	380	115799	261	119298	337	127273	154
107654	354	113822	276	115799	289	120813	58	127273	192
107654	388	113822	328	115799	341	120813	60	127273	194
107889	129	113822	379	115799	411	120813	98	127279	30
107889	150	113981	328	116272	55	120813	140	127279	40
107889	152	113983	276	116272	56	120813	151	127473	233
107889	179	113983	328	116272	178	120813	152	127473	249
107889	182	113983	380	116313	178	120813	153	127473	328
107889	189	113983	409	116316	178	121535	187	127473	380
108123	216	114055	268	116446	211	121791	196	127473	409
108123	233	114055	302	116446	223	121868	199	127498	267
108123	250	114055	354	116446	239	122146	262	127498	301
111074	251	114055	396	116458	74	122146	292	127498	353
111074	289	114141	58	116504	9	122146	344	127498	395
111074	342	114141	60	116554	210	122146	389	127501	267
111074	412	114198	178	116554	220	122213	266	127501	301
111075	289	114211	55	116554	236	122213	299	127501	353
111075	341	114211	56	116886	55	122213	352	127501	395
111075	412	114211	180	117569	232	122611	263	127502	213
111192	97	114211	182	117569	249	122611	292	127502	227
111192	140	114211	186	117970	141	122611	344	127502	244
111538	151	114215	179	118024	196	122611	390	127502	270
111538	194	114316	56	118196	151	122611	393	127502	305
111538	200	114316	180	118228	56	123094	251	127502	359
111538	194	114316	182	118230	56	123123	275	127808	217
111544	194	114316	186	118500	220	123507	276	127808	233
111568	214	114335	8	118500	210	123507	328	127808	250
111671	210	114495	1	118500	236	123507	380	127808	276
111671	220	114514	18	118555	215	123507	409	127808	329

## NUMERICAL INDEX

Part No.	Page No.	Part No.	Page No.	Part No.	Page No.	Part No.	Page No.	Part No.	Page No.
127808	380	132131	178	135339	405	137974	10	139160	210
127808	410	132142	56	133339	406	138121	150	139160	220
127858	70	132142	180	134163	216	138121	152	139160	236
128008	178	132148	185	134163	233	138147	151	139241	150
128040	217	132162	179	134163	250	138153	151	139241	152
128040	233	132162	184	134312	200	138154	151	139457	277
128040	250	132167	179	134315	200	138155	151	139457	329
128040	277	132167	183	134317	201	138261	215	139457	381
128040	329	132167	185	134318	200	138261	229	139457	410
128040	380	132429	321	134319	201	138261	245	139489	42
128040	410	132429	373	134321	200	138261	271	139508	161
128082	55	132429	403	134323	200	138261	315	139508	164
128287	187	132429	404	134324	200	138261	364	139509	8
128288	187	132429	405	134327	200	138584	151	139515	174
128289	187	132429	406	134328	201	138600	152	139521	50
128290	187	132447	27	134329	200	138602	152	139769	56
128291	187	132447	29	134483	83	138624	152	139804	209
128467	276	132449	79	135022	305	138694	8	139910	275
128467	329	132472	79	135117	276	138694	25	139910	327
128467	380	132526	56	135117	328	138705	10	139910	379
128541	178	132776	187	135117	380	138706	10	139910	408
128541	182	132876	216	135117	409	138707	10	140007	232
128827	67	132878	406	135807	264	138708	10	140007	246
128828	67	132972	273	135807	295	138753	9	140008	322
129439	101	132972	321	135807	348	138754	9	140008	374
129773	44	132972	368	135807	392	138890	10	140009	274
129773	45	132972	371	135910	174	138891	9	140009	322
129773	69	132972	372	136008	321	138896	10	140009	374
129773	72	132972	373	136008	373	138897	9	140065	199
130869	211	132972	403	136008	403	138898	9	140065	201
130869	224	132972	404	136008	404	138908	151	140067	150
130869	240	132972	405	136008	405	138917	7	140067	152
130869	291	132972	406	136008	406	138917	13	140073	152
130869	262	133004	281	136593	267	139046	214	140073	154
131046	179	133004	333	136593	268	139046	228	140075	12
131046	182	133004	387	136593	299	139046	244	140076	30
131046	209	133104	219	136593	302	139086	12	140076	40
131046	219	133104	209	136593	352	139150	211	140076	41
131046	235	133104	235	136593	354	139150	220	140079	151
131046	251	133104	257	136593	388	139150	239	140079	154
131046	257	133104	279	136593	400	139150	262	140079	194
131046	279	133104	331	136982	170	139150	289	140083	10
131046	331	133147	43	137108	196	139150	342	140174	406
131046	383	133264	273	137108	196	139150	412	140422	151
131316	322	133264	321	137109	55	139157	210	140855	187
131316	371	133264	368	137142	56	139157	220	140900	216
131316	373	133264	371	137153	56	139157	236	140900	233
131316	404	133264	372	137510	236	139157	239	140900	250
131809	209	133264	373	137510	341	139157	262	140900	380
131809	219	133264	403	137510	411	139157	289	140935	216
131809	235	133264	404	137537	215	139157	342	140935	233
131809	257	133264	405	137537	229	139158	210	140935	250
131809	279	133339	321	137537	245	139158	220	140935	276
131809	331	133339	368	137537	271	139158	236	140935	328
131809	383	133339	371	137537	312	139158	239	140935	380
132012	173	133339	372	137537	364	139159	211	140935	409
132012	174	133339	373	137960	7	139159	223	140942	258
132121	180	133339	403	137960	25	139159	239	140942	280
132122	180	133339	404	137972	10	139159	262	140942	332



## NUMERICAL INDEX

Part No.	Page No.	Part No.	Page No.	Part No.	Page No.	Part No.	Page No.	Part No.	Page No.
141305	216	143554	272	147114	292	156317	201	156857	409
141305	274	143554	317	147114	344	156318	201	156971	178
141345	151	143554	371	147114	389	156319	200	157018	267
141358	151	143554	372	147241	98	156346	216	157018	301
141358	153	143554	373	147298	174	156346	233	157018	353
141459	151	143554	404	147381	79	156346	249	157018	395
141459	153	143615	263	147381	82	156346	276	157022	277
141460	151	143615	295	147381	200	156346	328	157022	329
141460	153	143615	348	147406	69	156346	380	157022	380
141649	65	143615	392	147406	268	156346	409	157022	410
141649	212	144217	152	147649	258	156348	216	157432	30
141649	264	144514	125	147649	281	156348	233	157435	7
141710	79	144567	11	147649	333	156348	276	157477	68
141903	151	144731	26	147649	387	156348	328	157477	71
141903	153	144765	24	147910	321	156348	380	157477	127
141960	9	144770	198	147910	372	156348	249	157477	232
141987	73	144782	198	147910	373	156406	311	157477	246
142005	192	144785	41	147910	402	156406	360	157477	274
142793	263	144891	192	147910	405	156494	96	157477	322
142849	306	144911	79	147910	406	156541	276	157477	374
142849	360	144926	44	147963	211	156541	328	157584	267
142989	146	144930	129	147963	224	156596	232	157584	301
142989	149	145255	126	147963	240	156596	249	157584	353
142994	109	145258	24	147963	262	156596	327	157584	395
143130	79	145383	215	148024	26	156596	379	157585	267
143130	82	145383	229	148025	26	156596	408	157585	301
143130	256	145383	245	148073	12	156625	30	157585	353
143130	407	145383	271	148074	11	156625	31	157585	395
143143	1	145383	315	148075	12	156625	34	157586	217
143143	23	145383	364	148076	9	156625	35	157586	233
143143	84	145384	215	148079	9	156625	67	157586	250
143360	27	145384	229	148085	11	156625	70	157586	277
143360	79	145384	245	148098	9	156625	125	157586	329
143360	215	145384	271	148304	214	156626	30	157586	380
143360	232	145384	315	148304	228	156626	31	157586	410
143360	246	145384	364	148304	244	156626	34	157625	268
143360	322	145661	42	148338	302	156626	35	157625	301
143360	374	145661	43	148338	268	156626	67	157625	353
143442	74	145661	44	148338	395	156626	70	157625	396
143442	76	145661	255	148339	268	156626	125	157688	215
143459	151	145661	399	148339	302	156681	217	157688	246
143459	154	145662	179	148440	196	156681	276	157688	274
143460	151	145668	10	148637	210	156689	216	157688	322
143460	154	146088	56	148637	220	156689	275	157688	82
143461	151	146091	9	148637	236	156689	327	157688	232
143461	154	146103	263	148742	217	156689	379	157692	45
143462	151	146103	295	148742	233	156689	408	157696	189
143462	154	146103	347	148742	250	156691	275	157711	79
143463	151	146269	83	148846	205	156692	216	158003	206
143463	154	146272	83	148846	206	156692	233	158145	196
143476	26	146273	83	148884	56	156692	249	158146	196
143478	26	146274	83	148957	52	156692	276	158147	196
143480	26	146316	205	148974	43	156692	328	158159	1
143483	24	146317	205	148994	42	156692	379	158375	54
143487	22	146405	79	148996	42	156692	409	158459	25
143488	22	146412	83	148996	43	156696	276	158460	26
143489	22	146888	325	156312	200	156696	328	158470	26
143522	75	146888	377	156313	200	156696	379	158669	98
143552	73	146955	176	156314	200	156696	409	158994	352

## NUMERICAL INDEX

Part No.	Page No.	Part No.	Page No.	Part No.	Page No.	Part No.	Page No.	Part No.	Page No.
158994	299	163172	216	164249	245	166445	240	167945	291
159060	210	163172	276	164277	216	166446	224	168020	210
159060	220	163205	152	164280	216	166446	240	168020	220
159060	236	163207	56	164282	216	166478	233	168020	236
159060	261	163374	26	164283	216	166478	249	169041	58
159060	289	163380	233	164359	259	166478	327	169042	145
159060	341	163380	249	164359	282	166478	379	169049	2
159085	209	163380	328	164359	337	166479	233	169102	211
159085	219	163380	380	164359	385	166479	249	169102	223
159085	235	163424	8	164370	275	166479	327	169102	240
159187	216	163425	8	164373	276	166479	379	169102	262
159187	233	163427	8	164635	11	166480	233	169102	291
159187	249	163429	8	164636	11	166480	249	169167	180
159187	276	163434	11	164637	11	166480	327	169171	12
159187	328	163435	8	164679	259	166480	379	169182	10
159187	379	163436	11	164699	282	166832	11	169182	15
159187	409	163453	11	164699	337	166870	10	169182	25
159714	187	163454	11	164700	259	166872	41	169192	12
159878	180	163455	8	164700	385	166872	332	169194	8
159879	180	163456	11	164724	205	166901	275	169195	8
159950	217	163461	8	165014	210	167069	209	169198	8
159984	216	163463	11	165014	220	167069	258	169199	8
159984	276	163464	11	165014	236	167069	387	169249	328
161778	276	163465	11	165015	210	167250	259	169311	12
161778	328	163466	12	165015	220	167250	282	169322	8
161778	380	163468	11	165015	236	167250	337	169323	8
161778	409	163469	8	165021	210	167261	17	169547	44
161787	216	163477	56	165021	220	167261	27	169548	44
161787	233	163484	74	165021	236	167261	29	169549	41
161787	249	163484	76	165541	210	167261	77	169550	44
161787	276	163743	211	165542	210	167261	79	169564	205
161787	328	163743	224	165641	379	167261	203	169564	206
161787	379	163743	240	165759	210	167261	232	169567	205
161787	409	163745	211	165759	220	167261	246	170003	180
161792	220	163745	240	165759	236	167261	325	170006	178
161792	236	163745	224	166330	44	167261	377	170009	180
161792	289	163765	214	166400	30	167261	400	170018	180
161792	341	163766	263	166403	387	167422	276	170074	12
161794	220	163766	295	166404	30	167422	328	170074	18
161794	236	163766	348	166404	31	167422	380	170074	28
162217	272	163767	263	166404	34	167433	276	170074	205
162217	317	163767	295	166404	209	167434	276	170310	216
162217	371	163767	348	166404	258	167438	275	170310	233
162389	52	163767	392	166404	387	167438	327	170310	249
162552	44	163885	212	166405	258	167438	379	170310	276
162552	45	164003	8	166405	387	167438	408	170310	328
162552	145	164004	11	166406	209	167638	23	170335	261
162552	149	164005	11	166406	258	167638	110	170335	286
162627	26	164153	216	166406	387	167660	43	170335	341
162750	73	164155	216	166426	265	167924	209	170336	261
162750	75	164198	214	166426	296	167924	219	170336	286
162957	26	164198	228	166426	348	167924	235	170336	341
162979	95	164198	245	166442	224	167924	257	170401	83
162980	73	164199	214	166442	240	167924	279	170689	261
162980	75	164199	228	166443	224	167924	331	170722	196
163067	256	164199	245	166443	240	167945	211	170879	73
163067	407	164239	394	166444	224	167945	223	170913	43
163168	404	164249	214	166444	240	167945	240	170945	73
163168	405	164249	228	166445	224	167945	262	170945	77

## NUMERICAL INDEX

Part No.	Page No.	Part No.	Page No.	Part No.	Page No.	Part No.	Page No.	Part No.	Page No.
170966	401	172294	269	173513	391	175659	228	176289	227
171001	299	172294	291	173514	272	175659	245	176289	244
171001	351	172294	343	173514	316	175660	214	176289	254
171061	73	172294	366	173514	368	175660	229	176296	214
171196	180	172326	233	173537	273	175660	245	176296	228
171196	184	172326	249	173541	26	175757	236	176296	244
171198	185	172327	233	173814	210	175757	262	176300	214
171533	281	172327	249	173814	220	175757	289	176301	214
171533	334	172470	217	173814	236	175757	342	176301	228
171570	195	172470	233	173863	9	175757	412	176301	244
171572	179	172470	250	173952	210	175763	371	176304	214
171572	183	172470	277	173952	220	175763	402	176304	228
171574	180	172470	329	174093	9	175763	403	176304	244
171574	184	172470	381	174096	9	176077	302	176307	267
171574	185	172470	410	174098	9	176077	354	176307	300
171578	179	172754	290	174113	210	176078	219	176307	352
171578	183	172754	342	174113	220	176078	235	176312	213
171580	223	173133	232	174113	236	176078	280	176312	227
171580	239	173133	246	174114	210	176078	333	176312	244
171580	257	173133	322	174114	220	176100	214	176313	213
171580	290	173133	374	174114	236	176100	228	176313	227
171588	73	173148	263	174115	210	176100	244	176313	244
171692	211	173149	295	174115	220	176102	214	176314	213
171692	223	173149	347	174115	236	176102	228	176314	227
171692	240	173149	391	174116	210	176102	244	176314	243
171692	262	173150	263	174116	220	176103	228	176315	213
171692	291	173150	295	174116	236	176103	214	176315	227
171698	211	173150	347	174223	210	176103	245	176315	243
171698	223	173150	391	174223	220	176104	214	176318	213
171698	240	173187	203	174223	236	176104	228	176318	227
171698	262	173243	276	174501	213	176104	244	176318	244
171698	291	173243	328	174501	227	176105	214	176498	214
171703	211	173243	379	174501	243	176105	228	176545	217
171703	223	173243	409	174513	216	176105	244	176578	216
171703	240	173312	266	174513	233	176106	214	176578	232
171703	262	173312	299	174513	249	176106	228	176578	249
171703	291	173312	352	174513	276	176106	244	176578	275
171863	332	173313	263	174513	328	176124	210	176578	327
171899	258	173313	295	174513	379	176124	220	176578	379
171943	11	173313	347	174513	409	176124	236	176579	216
171944	11	173313	391	174637	179	176125	210	176579	232
171947	11	173333	151	174637	183	176125	220	176579	249
171948	11	173357	73	175011	177	176125	236	176579	275
171969	142	173357	75	175026	177	176133	214	176594	179
172133	266	173364	73	175144	268	176133	228	176594	184
172133	299	173364	75	175144	302	176133	244	176595	180
172133	352	173364	77	175144	354	176207	267	176638	213
172204	258	173367	27	175234	216	176207	300	176638	227
172204	290	173367	44	175234	233	176207	352	176638	243
172204	332	173367	45	175234	249	176282	255	176638	254
172205	257	173398	9	175234	276	176282	267	176650	214
172205	280	173411	396	175234	328	176282	300	176650	228
172205	332	173415	272	175234	379	176282	352	176650	244
172284	272	173415	318	175355	180	176282	400	176657	213
172284	318	173421	321	175364	179	176288	213	176657	227
172294	213	173490	258	175364	184	176288	227	176657	244
172294	223	173513	263	175441	196	176288	243	176657	254
172294	240	173513	295	175442	195	176288	254	176658	213
172294	253	173513	347	175659	214	176289	213	176658	227



## NUMERICAL INDEX

Part No	Page No	Part No	Page No	Part No	Page No	Part No	Page No	Part No	Page No
176658	244	177851	274	180134	344	180415	177	180704	220
176659	213	177851	322	180134	389	180417	177	180704	236
176659	227	177851	374	180152	273	180517	147	180750	150
176659	244	177851	407	180153	273	180523	147	180750	152
176677	299	178504	216	180209	174	180523	150	180751	151
176677	352	178642	10	180212	173	180531	147	180756	216
176683	302	178705	213	180295	273	180533	147	180758	174
176683	354	178705	227	180300	273	180535	147	180762	174
176688	214	178705	243	180301	65	180536	147	180798	176
176688	228	178926	318	180301	212	180537	147	180799	176
176688	245	178926	372	180301	264	180538	147	180800	173
176778	227	178927	272	180307	65	180539	147	180800	174
176778	244	178928	316	180307	212	180540	147	180801	175
176784	216	178928	272	180307	264	180541	147	180801	176
176736	213	178949	272	180326	214	180542	147	180803	57
176786	227	178949	316	180326	228	180543	147	180826	147
176786	243	178949	372	180326	244	180545	147	180842	212
176787	318	178961	276	180339	173	180546	147	180842	263
176787	372	178961	329	180340	175	180547	147	180844	212
176788	210	178961	380	180341	174	180550	174	180844	263
176788	220	178986	327	180356	174	180550	175	180844	295
176788	236	179077	272	180356	177	180550	176	180845	212
176799	228	179077	305	180357	174	180581	175	180845	224
176799	245	179077	359	180357	177	180585	54	180845	240
176816	212	179081	272	180358	176	180636	259	180845	263
176816	227	179082	272	180358	177	180636	281	180845	295
176816	243	179123	268	180368	174	180636	334	180909	127
176817	280	179123	302	180368	177	180636	388	180912	175
176817	332	179123	354	180370	174	180638	267	180913	176
176848	189	179131	398	180370	177	180645	213	180929	203
176849	189	179153	11	180384	175	180645	227	180938	127
176863	134	179157	175	180384	177	180645	244	180949	204
176864	46	179247	174	180386	166	180645	270	181019	216
176864	53	179251	387	180386	175	180645	305	181036	224
176864	78	179401	233	180386	177	180645	359	181036	227
176864	75	179401	249	180388	175	180646	213	181036	240
176864	317	179401	327	180388	177	180646	227	181036	243
176894	192	179401	379	180390	175	180646	244	181036	295
177000	318	179526	267	180390	177	180646	270	181036	300
177000	372	179531	195	180394	166	180646	305	181036	347
177001	373	179575	26	180394	175	180646	359	181043	295
177002	373	179578	26	180394	177	180647	213	181044	295
177003	318	179586	258	180396	166	180647	227	181055	205
177003	373	179680	259	180396	175	180647	244	181141	224
177006	213	179680	282	180396	177	180647	270	181141	227
177006	227	179680	337	180398	166	180647	305	181141	240
177006	244	179708	274	180398	175	180647	359	181141	243
177006	254	179717	212	180398	177	180666	212	181141	295
177021	210	179717	263	180401	177	180666	263	181141	300
177021	220	179817	201	180402	177	180671	371	181141	302
177021	236	179843	26	180403	177	180671	373	181141	347
177285	25	180082	251	180404	177	180671	402	181141	353
177286	10	180082	258	180405	177	180671	405	181221	76
177609	289	180082	280	180406	177	180671	406	181401	25
177609	341	180082	332	180407	177	180693	272	181402	10
177669	147	180082	384	180411	177	180703	210	181402	15
177840	274	180134	211	180412	177	180703	220	181404	203
177851	232	180134	262	180413	177	180703	236	181438	203
177851	246	180134	292	180414	177	180704	210	181480	300

## NUMERICAL INDEX

Part No.	Page No.	Part No.	Page No.	Part No.	Page No.	Part No.	Page No.	Part No.	Page No.
181533	333	182439	235	183173	368	183986	328	184699	65
181537	272	182439	251	183257	273	183986	380	184710	147
181537	318	182439	257	183258	273	183986	409	184716	212
181686	295	182439	331	183259	213	184024	211	184722	141
181686	347	182439	279	183259	224	184024	223	184753	65
181686	391	182448	79	183259	240	184024	240	184753	264
181695	263	182449	79	183280	213	184028	373	184754	65
181695	292	182450	80	183280	224	184029	373	184754	264
181695	344	182459	36	183280	240	184048	273	184757	65
181695	390	182459	72	183394	210	184049	273	184758	65
181697	263	182459	281	183429	317	184052	272	184761	65
181697	292	182459	334	183429	372	184052	318	184761	212
181697	344	182459	387	183432	316	184052	372	184762	65
181697	390	182478	79	183432	372	184053	272	184762	212
181702	263	182479	204	183463	232	184053	318	184796	281
181702	292	182479	205	183463	246	184053	372	184796	334
181702	344	182627	276	183463	322	184057	273	184796	387
181702	390	182627	328	183463	274	184236	216	184810	175
181703	263	182628	276	183463	374	184236	233	184810	176
181703	292	182628	328	183465	82	184236	250	184834	58
181703	344	182628	379	183528	212	184249	267	184835	79
181703	390	182687	217	183528	263	184249	300	184839	50
181732	321	182687	233	183672	280	184249	312	184851	389
181759	272	182687	250	183672	332	184249	363	184852	389
181759	318	182687	277	183673	280	184249	352	184853	388
181828	203	182687	410	183673	332	184249	363	184863	328
181873	204	182894	216	183741	277	184249	398	184863	379
181965	269	182894	276	183741	329	184268	388	184863	409
181965	295	182894	409	183741	380	184270	388	184988	30
181966	292	183000	79	183741	410	184308	161	184998	40
181966	268	183001	79	183761	141	184329	43	184994	170
181989	263	183002	79	183763	141	184332	82	184998	198
181989	292	183007	24	183764	141	184333	82	185031	76
181989	344	183011	26	183770	141	184335	22	185031	155
181989	390	183012	26	183836	254	184335	82	185031	213
182123	80	183068	43	183836	300	184346	26	185031	259
182215	3	183068	170	183836	352	184410	151	185031	270
182215	5	183072	74	183836	397	184410	153	185031	281
182215	6	183072	76	183838	321	184441	368	185031	305
182252	156	183076	58	183838	368	184467	9	185031	333
182283	56	183111	46	183838	371	184471	110	185031	359
182308	198	183153	22	183839	321	184478	45	185037	343
182324	5	183153	82	183839	368	184478	79	185063	74
182324	172	183170	252	183839	371	184497	196	185063	76
182377	65	183170	260	183839	372	184505	270	185064	74
182377	69	183170	285	183839	373	184505	306	185064	76
182377	269	183170	337	183843	300	184505	360	185065	74
182377	305	183170	338	183843	352	184555	233	185065	76
182377	332	183170	386	183844	281	184555	249	185068	76
182377	359	183171	252	183844	334	184555	327	185111	253
182377	384	183171	260	183850	272	184555	379	185111	343
182377	396	183171	285	183850	318	184571	195	185111	389
182386	261	183171	333	183850	372	184609	82	185112	343
182387	261	183171	386	183851	272	184610	82	185113	253
182387	286	183172	273	183851	318	184611	82	185113	343
182432	68	183172	318	183851	372	184659	259	185113	388
182434	272	183172	368	183882	273	184659	282	185114	253
182439	209	183173	273	183882	321	184659	337	185114	343
182439	219	183173	318	183962	157	184698	65	185114	389

## NUMERICAL INDEX

Part No.	Page No.	Part No.	Page No.	Part No.	Page No.	Part No.	Page No.	Part No.	Page No.
185118	253	185273	383	185576	272	185703	262	185799	364
185118	343	185274	209	185577	272	185704	211	185800	215
185118	389	185274	219	185578	272	185704	262	185800	229
185141	274	185274	235	185582	272	185705	211	185800	245
185142	210	185274	251	185585	261	185705	262	185800	271
185142	220	185274	257	185586	261	185709	211	185800	315
185142	236	185274	279	185587	272	185709	262	185800	364
185143	210	185274	331	185588	272	185710	261	185808	215
185143	220	185274	363	185589	273	185710	286	185808	229
185143	236	185274	383	185590	273	185710	338	185808	246
185174	161	185276	272	185592	273	185711	261	185808	271
185175	161	185278	272	185593	273	185711	338	185808	316
185176	161	185279	272	185594	272	185711	286	185808	367
185177	161	185280	272	185595	272	185712	261	185809	215
185178	161	185301	213	185600	259	185713	261	185809	229
185179	161	185304	272	185600	282	185714	273	185809	246
185180	161	185305	272	185600	337	185715	261	185809	271
185181	161	185305	316	185600	385	185716	261	185809	315
185185	161	185306	272	185601	252	185719	262	185809	367
185186	161	185306	316	185601	259	185734	260	185812	264
185188	161	185308	272	185601	282	185735	260	185813	264
185189	161	185308	316	185601	337	185736	260	185814	215
185211	276	185336	272	185601	385	185755	264	185814	229
185211	379	185336	318	185602	259	185756	264	185814	246
185211	409	185346	272	185602	282	185757	265	185814	271
185233	210	185346	317	185602	337	185758	265	185814	316
185233	220	185347	272	185602	385	185765	274	185814	367
185233	236	185347	318	185604	321	185767	265	185826	257
185235	210	185347	372	185616	281	185768	265	185826	290
185235	220	185363	82	185616	259	185770	275	185828	260
185235	236	185412	261	185616	334	185771	264	185831	275
185236	255	185412	289	185616	388	185776	215	185832	186
185236	260	185412	342	185646	261	185776	229	185832	388
185236	286	185412	412	185647	261	185776	245	185879	265
185236	338	185416	141	185650	261	185776	271	185893	65
185236	400	185433	82	185650	286	185776	364	185893	212
185270	209	185435	175	185650	338	185776	312	185893	215
185270	219	185436	152	185661	266	185778	261	185893	229
185270	235	185467	275	185662	266	185779	261	185893	246
185270	251	185467	327	185663	266	185784	290	185893	264
185270	257	185467	379	185664	266	185793	215	185893	271
185270	279	185488	277	185669	265	185794	215	185893	315
185270	331	185488	329	185670	265	185797	215	185893	367
185270	363	185553	260	185671	265	185797	229	185911	265
185270	383	185554	260	185672	265	185797	245	185916	275
185271	209	185555	260	185674	266	185797	271	185918	269
185271	257	185556	260	185675	266	185797	315	185924	274
185271	279	185557	260	185676	296	185797	367	185925	274
185272	209	185558	260	185676	351	185798	215	185926	266
185272	257	185559	260	185684	316	185798	229	185927	266
185272	279	185560	260	185685	316	185798	245	185928	266
185273	209	185561	259	185697	261	185798	315	185934	274
185273	219	185562	259	185700	261	185798	271	185935	274
185273	235	185565	260	185700	286	185798	364	185936	274
185273	251	185566	260	185700	338	185799	215	185937	246
185273	257	185567	260	185701	261	185799	229	185938	215
185273	279	185568	260	185702	211	185799	245	185938	229
185273	331	185570	272	185702	262	185799	271	185938	246
185273	363	185570	318	185703	211	185799	315	185938	271

## NUMERICAL INDEX

Part No.	Page No.	Part No.	Page No.	Part No.	Page No.	Part No.	Page No.	Part No.	Page No.
185938	316	186945	26	187260	142	187495	212	187642	51
185938	367	186954	54	187260	147	187495	264	187643	51
185947	274	186956	54	187260	209	187498	211	187644	51
185948	266	186957	54	187260	219	187498	223	187645	51
185949	266	186963	155	187260	235	187498	240	187653	265
185950	266	186981	2	187260	258	187498	262	187654	265
185951	266	186981	188	187260	281	187498	291	187657	265
185956	266	186982	2	187260	333	187522	227	187658	265
185957	266	186982	188	187280	262	187522	243	187659	265
185958	266	186983	188	187285	257	187522	269	187660	265
185959	266	186986	2	187285	279	187522	300	187668	260
185960	266	187000	274	187285	331	187530	280	187674	274
185961	266	187007	265	187293	267	187531	280	187675	274
185962	266	187011	274	187295	30	187536	280	187681	274
185963	266	187012	265	187295	67	187536	332	187685	260
185972	266	187013	265	187309	300	187537	280	187689	274
185973	266	187016	265	187309	302	187537	332	187698	281
185998	265	187017	265	187314	280	187542	280	187698	333
185999	265	187076	51	187314	332	187543	280	187705	281
186023	79	187077	51	187315	280	187544	223	187705	334
186032	174	187098	312	187315	332	187544	239	187716	281
186032	177	187098	363	187337	269	187544	257	187716	333
186033	174	187102	51	187338	269	187544	290	187727	301
186033	177	187103	51	187391	271	187549	265	187727	353
186083	153	187113	262	187391	311	187550	265	187728	301
186140	46	187124	265	187393	271	187551	266	187728	353
186140	47	187125	265	187393	311	187552	266	187729	267
186140	48	187126	271	187394	271	187561	359	187729	301
186192	199	187130	332	187394	311	187562	265	187729	353
186242	176	187131	332	187406	280	187563	265	187730	267
186243	176	187134	223	187407	280	187564	265	187730	301
186320	30	187134	239	187410	211	187577	269	187730	353
186320	73	187134	290	187410	224	187580	52	187736	295
186321	30	187137	215	187410	240	187581	52	187736	263
186321	73	187137	229	187410	262	187582	52	187736	347
186327	73	187137	245	187410	291	187583	52	187738	263
186328	73	187137	271	187411	211	187589	51	187739	263
186329	73	187137	315	187411	224	187590	51	187739	295
186330	73	187137	364	187411	240	187594	258	187739	347
186330	75	187144	332	187411	262	187594	280	187740	263
186330	78	187145	265	187411	291	187594	332	187744	299
186501	151	187146	265	187416	69	187596	257	187744	351
186501	154	187147	264	187416	264	187596	280	187763	260
186595	9	187148	264	187417	211	187596	332	187773	268
186611	196	187159	51	187417	262	187597	388	187773	301
186615	196	187160	51	187421	211	187609	281	187773	353
186625	196	187192	271	187421	224	187609	333	187774	291
186696	175	187192	315	187421	240	187627	209	187774	343
186697	175	187192	364	187421	262	187627	257	187803	251
186704	54	187221	257	187421	291	187631	211	187803	384
186737	53	187221	290	187421	343	187631	262	187826	258
186739	53	187224	259	187421	389	187632	211	187826	280
186778	189	187225	273	187442	332	187632	262	187828	267
186779	189	187226	273	187443	332	187633	211	187828	300
186780	189	187227	273	187444	276	187633	262	187828	352
186781	189	187228	273	187453	269	187634	211	187829	267
186838	196	187253	258	187454	269	187634	262	187829	300
186855	24	187258	295	187483	396	187635	216	187829	352
186888	54	187259	269	187495	65	187635	274	187833	373



## NUMERICAL INDEX

Part No.	Page No.	Part No.	Page No.	Part No.	Page No.	Part No.	Page No.	Part No.	Page No.
187834	373	190092	76	190300	154	190736	188	191014	11
187835	273	190088	68	190301	154	190739	4	191015	11
187835	321	190091	73	190305	2	190740	172	191022	8
187836	273	190091	76	190305	188	190741	172	191029	8
187836	321	190091	78	190317	155	190749	200	191030	8
187840	272	190091	79	190318	155	190756	188	191035	10
187840	318	190092	75	190319	155	190759	7	191038	10
187844	273	190092	78	190320	155	190760	7	191043	9
187844	322	190093	156	190327	172	190773	188	191044	9
187876	280	190094	156	190332	73	190783	2	191045	9
187877	280	190097	204	190332	76	190787	53	191046	9
187877	332	190119	40	190332	78	190797	179	191050	9
187878	273	190120	40	190342	54	190802	156	191052	9
187878	318	190121	40	190346	54	190803	156	191053	9
187879	273	190122	40	190391	66	190804	54	191056	9
187879	318	190124	40	190401	195	190805	2	191063	7
187879	373	190129	187	190411	196	190805	188	191064	7
187888	302	190134	57	190423	196	190824	178	191073	102
187889	268	190135	57	190441	196	190827	155	191104	3
187890	351	190148	2	190472	141	190828	155	191105	3
187897	266	190157	188	190507	151	190829	156	191123	25
187898	266	190171	46	190516	151	190830	156	191144	3
187899	266	190174	57	190517	151	190833	3	191150	82
187900	266	190175	57	190518	151	190834	3	191150	82
187910	213	190191	14	190523	150	190845	58	191151	4
187911	295	190191	26	190524	150	190847	58	191157	5
187913	267	190191	27	190527	150	190855	8	191157	7
187916	266	190191	29	190528	150	190885	30	191159	5
187917	266	190191	160	190529	150	190885	43	191161	5
187935	65	190191	162	190545	102	190904	22	191161	7
187935	264	190191	163	190546	152	190909	22	191167	30
187936	65	190191	164	190548	55	190912	15	191167	40
187936	264	190192	29	190550	102	190912	22	191168	40
187943	262	190192	158	190551	102	190912	25	191174	19
187946	262	190192	159	190552	102	190912	26	191174	20
187949	262	190192	160	190553	102	190916	82	191178	26
187965	272	190192	163	190554	102	190920	82	191189	172
187965	317	190192	185	190556	150	190923	68	191204	57
187977	273	190193	74	190616	29	190925	82	191209	170
187978	272	190196	2	190616	69	190928	22	191215	171
187978	373	190231	69	190636	172	190928	25	191222	57
187981	322	190231	72	190650	65	190930	172	191226	79
187981	373	190245	192	190650	69	190932	172	191228	79
187982	272	190246	171	190674	69	190934	172	191237	2
187982	316	190246	172	190674	212	190938	142	191246	30
187984	261	190291	8	190674	264	190939	142	191246	40
187988	265	190291	9	190680	57	190941	1	191247	187
187989	265	190291	10	190680	149	190942	3	191255	180
187990	265	190291	12	190681	187	190943	3	191255	186
187991	265	190291	14	180704	2	190952	1	191256	158
187998	271	190291	15	190706	2	190953	14	191257	158
190021	131	190291	17	190706	188	190953	25	191264	4
190042	67	190291	18	190718	47	190954	3	191266	171
190045	66	190291	25	190718	48	190955	3	191267	171
190045	158	190291	27	190719	2	190960	145	191268	171
190045	159	190291	28	190719	188	190961	22	191269	54
190045	160	190291	29	190721	188	190965	4	191269	171
190045	163	190298	154	190729	48	190984	189	191324	54
190046	67	190299	155	190735	2	191007	8	191325	54

## NUMERICAL INDEX

Part No.	Page No.	Part No.	Page No.	Part No.	Page No.	Part No.	Page No.	Part No.	Page No.
191327	171	191778	110	192303	216	193062	268	193138	360
191367	267	191781	10	192303	233	193062	302	193141	290
191368	212	191782	142	192303	250	193062	354	193142	311
191368	227	191783	10	192303	276	193063	268	193142	360
191368	243	191785	142	192303	328	193063	302	193147	270
191368	267	191786	142	192303	380	193063	354	193147	306
191368	301	191787	142	192303	409	193068	269	193147	359
191368	353	191791	19	192345	276	193069	269	193148	270
191393	19	191803	9	192345	329	193069	301	193148	306
191403	198	191803	14	192345	380	193069	353	193148	359
191403	199	191804	9	192345	409	193070	268	193149	306
191404	198	191805	11	192346	276	193070	292	193149	360
191404	199	191810	19	192346	329	193071	268	193150	306
191416	188	191810	20	192346	380	193071	292	193150	360
191431	20	191810	21	192346	409	193075	261	193154	270
191432	9	191829	159	192689	232	193075	286	193154	311
191437	19	191894	2	192689	249	193075	338	193154	363
191437	20	191895	188	192691	232	193076	261	193162	270
191437	21	191903	3	192691	249	193076	286	193162	306
191439	19	191911	82	192693	232	193076	338	193162	359
191466	146	191912	82	192693	249	193077	261	193164	311
191470	146	191922	19	192695	232	193078	252	193164	360
191477	5	191926	3	192695	249	193078	286	193165	261
191505	196	191927	3	193017	260	193078	338	193174	260
191507	196	191938	19	193018	260	193079	264	193174	285
191513	194	191939	4	193019	259	193080	264	193174	338
191514	194	191960	47	193020	259	193082	270	193177	260
191515	194	191961	170	193021	260	193082	306	193177	285
191516	194	191990	160	193021	285	193082	359	193177	338
191526	125	191991	160	193021	338	193083	306	193180	270
191552	150	191992	159	193022	272	193083	360	193180	300
191561	196	191994	160	193026	295	193084	306	193180	311
191562	196	191995	160	193027	269	193084	360	193181	270
191604	172	191996	160	193030	321	193087	270	193181	306
191606	172	192035	275	193031	321	193090	264	193181	359
191608	172	192037	275	193041	321	193092	270	193199	210
191610	172	192037	379	193042	321	193092	306	193199	220
191619	4	192037	408	193043	316	193092	359	193199	236
191634	170	192038	275	193044	272	193104	260	193199	261
191636	170	192088	249	193044	318	193105	260	193199	289
191642	150	192088	275	193045	272	193106	274	193199	341
191646	187	192088	379	193045	318	193106	322	193199	412
191647	40	192090	277	193046	272	193106	374	193200	210
191647	41	192090	329	193046	316	193107	274	193200	220
191654	142	192208	233	193047	272	193107	322	193200	236
191654	148	192208	250	193050	318	193107	374	193200	239
191656	5	192208	277	193054	260	193120	265	193200	261
191658	54	192208	329	193054	285	193122	265	193200	289
191658	171	192208	380	193054	337	193123	261	193200	341
191673	11	192209	233	193054	338	193123	286	193200	412
191674	11	192209	250	193056	270	193123	341	193201	210
191692	11	192209	277	193056	306	193124	261	193201	220
191693	180	192209	329	193056	360	193124	286	193201	236
191697	11	192209	380	193060	270	193124	341	193201	261
191708	11	192210	277	193060	306	193133	257	193201	289
191727	11	192218	276	193060	360	193133	290	193201	341
191773	9	192218	328	193061	270	193137	311	193201	411
191776	11	192294	275	193061	306	193137	360	193209	275
191777	11	192295	275	193061	360	193138	311	193209	325

## NUMERICAL INDEX

Part No.	Page No.	Part No.	Page No.	Part No.	Page No.	Part No.	Page No.	Part No.	Page No.
193221	268	193389	322	193497	214	193692	260	193863	213
193224	306	193389	374	193497	228	193692	285	193863	224
193224	360	193390	274	193497	244	193692	338	193863	240
193229	261	193391	274	193505	214	193695	260	193866	65
193229	286	193391	325	193505	228	193695	285	193866	212
193230	261	193391	374	193505	245	193695	338	193867	65
193230	289	193400	212	193506	214	193696	260	193867	212
193231	261	193400	224	193506	228	193696	285	193875	213
193231	289	193400	243	193506	245	193696	338	193875	227
193232	261	193401	212	193512	214	193730	383	193875	243
193232	289	193401	224	193512	228	193759	281	193877	213
193233	261	193401	243	193512	245	193759	333	193880	291
193233	289	193402	212	193513	214	193764	274	193881	291
193234	261	193402	224	193513	228	193791	213	193883	209
193234	286	193402	243	193513	245	193797	214	193883	257
193235	261	193403	212	193523	215	193798	214	193883	279
193235	286	193403	224	193526	215	193799	214	193893	281
193249	270	193403	243	193535	261	193800	214	193918	286
193249	306	193406	274	193535	286	193801	214	193918	338
193249	360	193406	325	193602	213	193801	228	193919	286
193269	274	193406	377	193602	224	193801	245	193919	338
193269	325	193407	274	193602	240	193802	214	193922	51
193271	268	193407	325	193603	213	193802	228	193923	51
193278	268	193407	377	193603	224	193802	245	193930	209
193293	269	193417	306	193603	240	193803	214	193930	219
193293	295	193417	360	193610	214	193803	228	193930	235
193295	269	193418	270	193610	228	193803	245	193930	257
193297	269	193418	306	193610	244	193804	214	193930	279
193297	295	193418	359	193611	214	193804	228	193930	331
193299	269	193421	268	193611	228	193804	245	193931	209
193301	274	193425	311	193611	244	193805	214	193931	219
193310	263	193425	360	193612	214	193805	228	193931	235
193310	265	193426	311	193612	228	193805	245	193931	257
193310	347	193426	360	193612	244	193806	214	193931	279
193312	265	193429	306	193629	270	193806	228	193931	331
193313	265	193429	359	193629	306	193806	245	193961	211
193314	265	193436	270	193629	360	193807	214	193961	223
193315	265	193436	311	193630	270	193807	228	193961	240
193317	265	193436	363	193630	306	193807	245	193979	270
193329	290	193436	377	193630	360	193808	214	194001	80
193342	215	193437	270	193642	210	193808	228	194004	72
193352	277	193437	306	193642	220	193808	245	194008	160
193352	329	193437	360	193642	236	193809	214	194008	163
193352	381	193438	270	193643	210	193809	228	194011	206
193352	410	193438	306	193643	220	193809	245	194019	205
193374	269	193438	360	193643	236	193810	214	194029	4
193374	300	193439	274	193653	215	193810	228	194030	4
193379	232	193450	214	193655	210	193810	245	194037	158
193379	246	193450	228	193655	220	193814	215	194045	159
193379	274	193450	244	193655	236	193814	229	194046	159
193379	322	193462	267	193656	210	193814	245	194047	160
193379	374	193462	301	193656	220	193826	209	194047	163
193380	274	193462	353	193656	236	193826	223	194050	158
193381	274	193465	216	193664	213	193826	240	194053	159
193382	274	193465	232	193666	213	193847	209	194054	159
193388	274	193465	249	193675	275	193848	209	194060	160
193388	322	193496	214	193689	275	193861	213	194061	160
193388	374	193496	228	193689	326	193861	224	194071	19
193389	274	193496	244	193689	377	193861	240	194083	188

## NUMERICAL INDEX

Part No.	Page No.	Part No.	Page No.	Part No.	Page No.	Part No.	Page No.	Part No.	Page No.
194087	204	194449	74	194714	175	194869	325	194985	275
194088	204	194450	74	194714	177	194869	377	194985	326
194092	204	194450	76	194719	171	194870	275	194985	377
194093	205	194453	74	194720	171	194871	273	194986	275
194143	171	194453	76	194732	4	194872	273	194986	326
194151	40	194459	150	194732	6	194873	274	194986	377
194162	170	194462	199	194732	14	194874	274	194987	275
194167	170	194465	45	194732	160	194875	274	194987	326
194182	151	194465	77	194745	24	194876	274	194987	377
194182	153	194528	160	194746	26	194877	274	194988	275
194183	150	194528	163	194750	176	194878	275	194988	326
194186	41	194536	160	194751	1	194878	326	194988	377
194190	200	194536	163	194752	1	194878	377	194992	9
194191	200	194539	74	194768	205	194879	275	195201	292
194193	200	194545	200	194769	205	194883	2	195201	344
194194	200	194546	200	194774	172	194883	188	195201	389
194195	200	194548	20	194777	8	194884	2	195209	233
194196	200	194548	21	194778	8	194884	188	195209	249
194197	200	194549	20	194782	127	194885	2	195209	327
194201	200	194549	21	194783	127	194885	188	195209	379
194202	200	194551	19	194784	200	194892	142	195212	321
194218	258	194552	19	194785	200	194893	142	195226	216
194219	258	194553	20	194786	200	194894	142	195226	276
194220	155	194553	21	194787	200	194894	148	195227	276
194221	155	194561	73	194791	176	194920	216	195236	268
194223	155	194568	5	194792	4	194921	216	195236	292
194224	155	194569	5	194793	4	194922	216	195238	268
194229	155	194570	5	194794	200	194923	216	195238	292
194230	155	194578	174	194795	200	194924	216	195240	268
194231	155	194578	175	194796	5	194925	216	195241	268
194232	155	194578	176	194802	176	194926	216	195242	211
194237	158	194579	174	194818	73	194927	216	195242	262
194238	158	194579	175	194819	73	194928	216	195243	268
194250	198	194579	176	194820	72	194929	216	195244	268
194251	198	194585	19	194817	72	194930	216	195245	268
194251	199	194597	160	194824	4	194939	275	195245	300
194257	4	194597	163	194829	142	194939	325	195246	268
194271	45	194598	45	194829	148	194939	377	195246	300
194271	79	194601	3	194831	142	194960	9	195247	268
194272	45	194601	6	194831	148	194974	68	195247	300
194286	219	194602	3	194833	204	194974	71	195248	268
194286	235	194602	6	194846	188	194975	74	195248	300
194286	280	194607	4	194847	188	194975	76	195249	268
194286	333	194643	42	194853	24	194977	43	195249	292
194298	187	194658	3	194859	275	194980	275	195249	344
194299	187	194659	3	194860	275	194980	326	195250	269
194314	43	194666	1	194861	275	194980	377	195251	269
194430	53	194668	74	194864	275	194981	275	195252	269
194431	54	194668	76	194864	326	194981	326	195252	295
194433	54	194669	30	194864	377	194981	377	195253	269
194434	54	194669	34	194865	275	194982	275	195253	295
194436	54	194669	74	194865	326	194982	325	195254	269
194437	54	194669	76	194865	377	194982	377	195255	269
194444	74	194671	54	194866	275	194983	275	195256	269
194446	74	194686	205	194867	275	194983	325	195664	289
194447	74	194687	205	194868	325	194983	377	195270	270
194447	76	194690	205	194868	275	194984	275	195270	306
194448	74	194691	205	194868	377	194984	325	195270	360
194448	76	194699	171	194869	275	194984	377	195300	290

## NUMERICAL INDEX

Part No.	Page No.	Part No.	Page No.	Part No.	Page No.	Part No.	Page No.	Part No.	Page No.
195301	290	195687	354	195786	286	196493	364	196680	191
195301	342	195691	266	195786	341	196516	194	196681	191
195338	328	195691	299	195787	261	196517	189	196684	194
195338	379	195691	351	195787	286	196519	195	196685	194
195340	289	195692	266	195787	341	196520	195	196686	194
195340	341	195692	299	195788	273	196521	194	196687	194
195341	261	195692	351	195789	273	196526	195	196688	194
195341	289	195694	257	195790	273	196527	195	196689	194
195341	341	195700	306	195790	321	196530	195	196690	194
195378	274	195700	360	195790	372	196538	195	196691	194
195391	274	195712	270	195791	273	196540	196	196692	195
195452	259	195713	311	195791	321	196541	194	196693	195
195453	259	195713	360	195791	372	196543	195	196694	195
195454	259	195717	272	195794	306	196545	194	196695	195
195456	259	195717	318	195794	360	196547	189	196700	154
195458	259	195718	270	195795	306	196548	189	196701	152
195461	259	195718	312	195795	360	196551	194	196708	152
195462	259	195719	271	195796	261	196552	195	196709	152
195463	259	195719	312	195797	270	196556	195	196718	154
195465	259	195720	311	195804	260	196557	195	196719	153
195467	259	195720	360	195805	260	196558	195	196720	153
195470	259	195732	306	195879	191	196573	189	196721	153
195471	259	195732	360	195900	9	196580	192	196722	153
195473	259	195737	316	195901	2	196581	195	196726	153
195476	259	195738	316	195902	2	196582	194	196728	152
195477	259	195741	317	195903	141	196583	194	196729	152
195480	259	195744	306	195904	67	196584	194	196730	152
195481	259	195744	360	195906	205	196585	194	196731	152
195483	210	195748	311	195906	206	196586	194	196735	153
195483	219	195748	360	195907	205	196587	194	196737	154
195483	235	195749	311	195909	205	196588	194	196738	153
195485	210	195749	360	195909	206	196589	194	196739	153
195485	219	195750	260	195910	204	196590	194	196740	153
195485	235	195751	260	195916	141	196591	195	196741	153
195487	210	195752	260	195924	150	196592	195	196742	154
195487	219	195753	260	195942	176	196593	195	196743	154
195487	235	195754	260	195943	174	196595	195	196768	79
195489	210	195755	260	195945	260	196596	194	196792	42
195489	219	195758	271	195946	260	196597	195	196807	151
195489	235	195760	264	195947	160	196600	189	196807	152
195490	257	195761	264	195948	160	196603	189	196808	151
195491	257	195766	265	195949	160	196604	189	196808	152
195492	272	195767	265	195993	53	196605	191	196847	204
195492	317	195768	264	196000	211	196610	191	196849	150
195664	220	195769	264	196000	223	196611	189	196849	152
195664	236	195772	265	196000	239	196612	191	196913	14
195664	341	195773	265	196034	272	196614	194	196934	174
195669	275	195778	261	196035	272	196615	194	196942	15
195672	275	195778	286	196119	373	196617	192	196950	75
195680	70	195778	341	196243	267	196618	189	196969	14
195683	269	195779	261	196243	301	196619	189	196972	34
195683	341	195779	286	196243	353	196620	189	196972	40
195684	215	195779	341	196243	395	196621	196	197024	178
195684	229	195780	261	196311	224	196623	195	197026	178
195684	245	195780	286	196311	292	196663	401	197027	178
195685	270	195780	341	196337	289	196675	191	197028	178
195685	311	195781	261	196337	342	196676	191	197035	180
195685	360	195781	286	196391	216	196677	191	197036	180
195686	215	195781	341	196391	276	196678	191	197052	15
195687	302	195786	261	196493	315	196679	191	197053	15



## NUMERICAL INDEX

Part No.	Page No.	Part No.	Page No.	Part No.	Page No.	Part No.	Page No.	Part No.	Page No.
197055	246	197685	130	197809	130	199170	229	199770	219
197057	14	197686	130	197814	101	199170	246	199770	235
197059	13	197693	109	197817	125	199170	271	199770	279
197062	13	197695	98	197818	97	199170	315	199770	331
197064	14	197696	98	197819	101	199170	367	199771	219
197065	16	197697	98	197820	141	199192	215	199771	235
197116	153	197698	98	197821	101	199192	229	199771	279
197117	153	197700	98	197822	125	199192	246	199771	331
197118	153	197705	83	197825	115	199192	271	199787	6
197145	56	197706	141	197828	97	199192	315	199787	232
197145	182	197707	130	197830	125	199192	367	199787	246
197145	186	197709	97	197831	140	199254	322	199787	322
197150	56	197711	83	197833	140	199254	372	199787	374
197260	109	197711	97	197834	140	199329	316	199848	212
197382	203	197714	140	197835	140	199329	367	199848	266
197401	276	197715	140	197836	140	199356	215	199849	212
197418	45	197720	141	197877	40	199356	271	199850	266
197426	187	197723	109	197877	44	199360	215	199851	266
197488	30	197730	98	197877	45	199360	229	199873	281
197488	31	197733	131	197890	150	199360	246	199873	334
197488	35	197736	129	197890	152	199360	271	199890	267
197488	36	197736	131	197891	150	199360	315	199892	258
197488	64	197738	130	197891	152	199360	367	199893	270
197488	69	197749	110	197895	158	199371	316	199895	258
197492	30	197750	109	197898	47	199374	255	199896	269
197492	31	197754	141	197903	158	199374	315	199896	305
197492	35	197755	128	197903	159	199374	364	199897	269
197492	66	197758	101	197910	158	199374	399	199897	305
197493	66	197759	128	197910	159	199425	341	199898	270
197496	85	197761	97	197911	159	199500	372	199899	259
197496	66	197762	126	197914	158	199504	372	199900	258
197496	67	197763	97	197916	158	199508	372	199902	273
197496	68	197764	126	197920	160	199571	371	199903	273
197531	125	197766	141	197920	164	199571	404	199905	267
197532	30	197767	129	197921	160	199641	224	199906	267
197532	34	197772	130	197924	160	199641	292	199907	273
197532	35	197775	130	197924	164	199643	224	199908	273
197532	67	197777	125	197926	160	199643	292	199909	269
197542	189	197778	140	197927	160	199705	235	199909	305
197547	1	197779	98	197927	164	199705	331	199910	269
197576	56	197781	140	197945	203	199707	212	199910	305
197577	55	197782	98	197949	158	199707	266	199911	269
197588	146	197783	130	197949	159	199709	212	199911	305
197591	145	197784	130	197962	66	199709	266	199912	269
197591	148	197787	125	197966	67	199718	224	199912	305
197621	171	197790	101	197968	67	199718	240	199913	259
197638	140	197791	101	197983	38	199718	295	199914	261
197639	141	197797	114	197983	43	199718	347	199915	273
197648	83	197798	84	197991	40	199722	224	199916	262
197649	97	197798	125	199045	224	199722	240	199917	267
197652	102	197802	126	199045	292	199722	295	199918	263
197652	130	197803	125	199045	344	199732	227	199919	267
197657	98	197804	84	199138	325	199732	244	199921	269
197677	130	197804	114	199138	374	199742	64	199921	305
197680	130	197804	125	199167	282	199742	212	199922	273
197681	130	197805	129	199167	334	199748	212	199923	269
197682	130	197806	125	199167	337	199748	266	199923	305
197683	83	197807	141	199167	385	199749	292	199923	332
197684	130	197808	125	199170	215	199749	344	199923	354

## NUMERICAL INDEX

Part No.	Page No.	Part No.	Page No.	Part No.	Page No.	Part No.	Page No.	Part No.	Page No.
199925	305	200925	232	201199	68	201368	191	201838	159
199932	305	200926	326	201200	65	201369	191	201860	141
199941	258	200927	326	201201	67	201370	191	201861	142
199965	385	200995	233	201208	30	201371	191	201862	147
200065	379	200995	249	201208	64	201372	191	201864	115
200073	289	200995	408	201209	142	201373	195	201865	114
200073	342	200996	233	201214	145	201374	195	201870	178
200073	412	200996	249	201215	142	201381	192	201871	178
200467	233	200996	327	201216	57	201389	194	201877	160
200467	249	200996	379	201218	141	201455	40	201885	54
200467	328	200996	408	201218	146	201455	41	201887	98
200467	379	201020	56	201218	149	201470	138	201894	141
200467	409	201020	95	201220	68	201481	45	201900	1
200478	258	201023	56	201222	97	201496	56	201905	1
200479	258	201031	13	201223	30	201497	57	201910	98
200480	258	201049	79	201223	57	201504	25	201919	130
200481	258	201049	82	201225	64	201505	138	201933	115
200482	209	201052	140	201225	264	201511	30	201936	97
200483	209	201053	114	201226	72	201511	69	201946	140
200525	233	201055	98	201227	72	201554	56	201947	115
200525	249	201057	110	201228	73	201558	176	201948	115
200525	328	201058	97	201229	64	201570	40	201963	155
200525	379	201059	97	201234	30	201570	44	201964	13
200525	409	201063	101	201234	35	201643	205	201974	140
200527	214	201066	110	201234	133	201643	206	201986	83
200527	228	201067	84	201236	4	201644	204	202056	15
200527	244	201068	97	201246	146	201644	205	202056	164
200568	177	201068	101	201250	4	201644	206	202175	31
200583	327	201069	101	201253	152	201646	205	202175	35
200584	327	201070	83	201259	152	201646	206	202175	36
200585	327	201071	83	201260	152	201654	1	202175	40
200586	327	201075	141	201311	48	201654	205	202176	30
200620	258	201090	55	201317	192	201654	206	202176	44
200621	258	201092	55	201324	192	201669	146	202188	146
200622	258	201095	55	201325	192	201669	149	202199	22
200623	258	201099	55	201326	192	201687	78	202201	23
200628	269	201102	54	201328	192	201710	30	202202	12
200629	269	201103	54	201329	192	201710	42	202202	23
200630	269	201119	30	201330	192	201721	29	202238	15
200631	269	201119	72	201331	192	201721	256	202241	15
200638	329	201120	145	201332	192	201721	407	202242	15
200638	380	201121	145	201344	189	201735	69	202243	10
200638	410	201122	145	201347	192	201736	41	202245	24
200639	329	201122	146	201348	195	201736	387	202247	25
200639	380	201128	54	201353	192	201737	41	202248	25
200639	410	201137	138	201354	191	201737	77	202249	15
200776	326	201138	138	201355	191	201741	180	202251	14
200777	326	201152	171	201356	191	201755	73	202251	24
200782	327	201155	171	201357	191	201755	75	202253	15
200789	327	201156	171	201358	191	201765	78	202253	22
200797	329	201167	48	201359	191	201766	78	202253	25
200817	327	201172	41	201360	191	201768	78	202254	24
200836	327	201179	48	201361	191	201779	58	202255	24
200837	327	201180	48	201362	191	201782	198	202261	29
200901	326	201182	146	201363	191	201811	47	202263	25
200901	378	201183	18	201364	191	201812	46	202267	25
200902	327	201195	30	201365	191	201812	47	202268	29
200902	378	201195	66	201366	191	201813	46	202280	25
200924	232	201198	68	201367	191	201838	158	202287	1

## NUMERICAL INDEX

Part No.	Page No.	Part No.	Page No.	Part No.	Page No.	Part No.	Page No.	Part No.	Page No.
202288	179	202456	10	202695	66	202892	28	203015	129
202288	183	202456	25	202695	67	202895	83	203016	30
202289	140	202458	25	202695	68	202898	30	203016	34
202290	23	202462	25	202696	65	202898	31	203016	97
202291	179	202469	23	202696	69	202898	35	203018	140
202291	183	202470	12	202697	53	202898	67	203019	140
202296	23	202470	23	202698	53	202899	12	203022	97
202297	178	202470	28	202699	16	202901	23	203023	97
202298	179	202475	25	202701	1	202901	28	203024	97
202298	183	202485	69	202715	16	202902	12	203039	83
202300	23	202491	199	202721	16	202903	125	203042	98
202305	179	202492	199	202747	16	202904	12	203045	110
202305	183	202509	25	202751	1	202908	30	203050	83
202310	23	202516	23	202760	55	202908	66	203056	131
202310	28	202523	23	202761	55	202909	46	203059	98
202318	24	202524	23	202762	55	202909	406	203061	140
202318	28	202532	23	202766	58	202911	10	203062	83
202320	179	202536	23	202767	58	202912	12	203063	83
202320	183	202537	23	202788	98	202916	12	203064	83
202330	28	202550	22	202789	98	202916	18	203065	83
202333	15	202572	18	202800	131	202917	22	203075	140
202355	25	202572	22	202801	131	202922	176	203076	140
202393	30	202572	139	202802	131	202926	42	203077	140
202393	42	202573	125	202803	131	202926	77	203080	158
202394	30	202573	139	202804	131	202927	10	203081	158
202394	42	202576	23	202805	131	202927	26	203082	158
202396	28	202578	68	202806	131	202928	22	203084	57
202404	73	202599	26	202807	131	202937	55	203085	125
202404	75	202602	199	202808	131	202938	55	203086	130
202406	73	202603	199	202809	131	202939	55	203101	46
202406	75	202605	24	202810	131	202940	68	203105	170
202412	73	202607	24	202811	131	202941	16	203106	170
202412	75	202610	26	202812	131	202942	55	203109	48
202413	73	202612	24	202813	131	202944	12	203110	48
202421	75	202613	26	202814	131	202945	12	203116	54
202422	76	202614	48	202815	131	202950	79	203117	54
202425	76	202615	48	202816	97	202953	141	203120	156
202425	78	202620	54	202817	97	202954	141	203121	156
202426	76	202621	54	202818	97	202958	55	203122	187
202426	78	202625	16	202828	12	202970	10	203123	186
202427	73	202629	169	202829	12	202971	30	203124	3
202427	75	202647	4	202832	25	202971	44	203126	30
202427	76	202648	4	202834	187	202972	30	203126	44
202429	30	202652	3	202835	187	202972	44	203132	187
202429	34	202670	142	202836	186	202987	10	203134	12
202429	35	202679	73	202838	131	202990	156	203137	65
202429	73	202679	75	202842	69	202991	156	203137	66
202429	75	202680	73	202862	46	202992	154	203138	66
202432	159	202680	75	202863	46	202993	154	203140	66
202433	159	202681	73	202868	2	202994	154	203141	65
202434	159	202681	75	202868	84	202995	154	203143	187
202435	159	202683	73	202872	22	202996	187	203144	187
202439	24	202683	75	202872	28	203001	131	203145	10
202446	27	202684	73	202876	98	203002	131	203146	10
202451	25	202684	75	202879	46	203008	131	203151	10
202452	27	202685	73	202886	16	203011	130	203153	10
202453	1	202685	75	202887	46	203012	101	203155	189
202454	27	202686	140	202890	23	203013	30	203156	40
202455	27	202695	64	202892	22	203014	131	203166	198

## NUMERICAL INDEX

Part No.	Page No.	Part No.	Page No.	Part No.	Page No.	Part No.	Page No.	Part No.	Page No.
203166	199	203533	203	203792	126	203925	73	204264	354
203170	203	203534	145	203795	179	203925	75	204346	328
203171	203	203542	72	203795	183	203926	270	204346	379
203175	146	203553	127	203796	185	203929	22	204354	312
203177	18	203557	127	203796	180	203930	69	204354	364
203177	22	203560	127	203796	184	203931	129	204417	228
203177	139	203562	127	203797	31	203932	129	204417	244
203178	18	203566	53	203800	178	203933	129	204418	228
203178	22	203567	53	203802	129	203940	141	204418	244
203178	139	203576	204	203802	131	203941	73	204419	228
203180	66	203579	204	203803	142	203942	73	204419	244
203182	12	203581	170	203803	148	203943	73	204428	299
203184	203	203587	204	203806	140	203943	75	204429	299
203187	18	203588	204	203808	141	203944	72	204430	299
203187	22	203589	204	203809	142	203945	73	204431	299
203188	203	203611	203	203809	148	203946	141	204436	299
203189	139	203634	84	203811	165	203950	140	204437	299
203192	203	203635	84	203812	165	203951	140	204438	299
203193	203	203652	49	203814	165	203952	140	204439	299
203196	78	203653	48	203815	141	203953	140	204444	299
203198	115	203665	187	203819	179	203954	140	204445	299
203199	66	203675	98	203819	184	203955	140	204448	299
203269	141	203688	170	203822	84	203956	140	204449	299
203270	141	203710	154	203832	192	203957	140	204452	299
203275	141	203711	154	203834	195	203958	66	204453	299
203280	141	203712	154	203836	194	203960	140	204454	224
203283	115	203718	154	203837	192	203961	141	204455	224
203284	98	203722	7	203838	192	203962	73	204455	243
203286	141	203723	7	203841	29	203962	75	204455	295
203287	109	203729	8	203842	29	203963	73	204455	348
203288	109	203730	154	203845	49	203963	75	204480	286
203293	142	203731	8	203846	49	203964	73	204480	338
203294	141	203732	187	203849	109	203964	75	204481	286
203301	76	203734	154	203852	26	203975	68	204481	338
203302	12	203735	154	203854	26	203976	101	204482	286
203309	141	203736	154	203860	18	203980	179	204482	338
203317	44	203777	179	203860	23	203980	183	204483	286
203319	23	203777	183	203870	145	203993	73	204483	338
203347	146	203778	179	203874	101	203994	73	204488	228
203377	45	203778	184	203878	147	203996	66	204488	244
203452	101	203779	184	203882	153	203996	179	204492	316
203453	101	203779	185	203883	140	203996	183	204493	316
203454	101	203780	30	203884	140	203997	179	204498	316
203458	146	203780	34	203886	152	203997	184	204499	316
203458	147	203780	35	203893	140	204195	213	204500	316
203460	142	203780	38	203894	171	204195	227	204501	316
203461	142	203780	179	203897	146	204195	243	204518	321
203466	146	203780	184	203897	149	204197	269	204518	372
203487	72	203781	180	203901	42	204197	302	204519	321
203495	72	203781	186	203901	69	204197	354	204533	326
203496	72	203782	148	203901	72	204221	269	204535	282
203497	26	203783	98	203902	16	204221	300	204535	334
203498	72	203784	98	203905	45	204234	269	204538	326
203499	145	203788	180	203905	176	204234	300	204538	377
203504	17	203788	184	203906	140	204257	213	204539	326
203506	11	203790	179	203911	141	204257	227	204539	377
203517	145	203790	184	203922	176	204257	243	204541	326
203528	22	203790	185	203923	83	204264	269	204541	377
203531	127	203791	126	203924	124	204264	302	204544	326

## NUMERICAL INDEX

Part No.	Page No.	Part No.	Page No.	Part No.	Page No.	Part No.	Page No.	Part No.	Page No.
204544	377	204712	285	204968	367	205172	83	205767	48
204546	326	204712	337	204978	321	205176	140	205768	49
204546	377	204713	285	204978	372	205200	83	205769	206
204547	326	204713	337	204979	321	205201	187	205774	26
204547	377	204736	286	204979	372	205225	15	205775	27
204548	213	204736	341	204980	281	205279	155	205783	129
204549	377	204737	286	204980	333	205280	155	205784	189
204552	268	204737	341	204992	229	205283	155	205799	146
204552	302	204738	286	204992	246	205284	155	205800	147
204552	354	204738	341	204993	229	205285	155	205817	125
204575	326	204739	286	204993	246	205286	155	205818	125
204575	377	204739	341	204995	322	205292	54	205819	125
204576	51	204780	296	204995	373	205293	54	205824	171
204577	51	204788	296	204996	305	205296	154	205827	66
204579	51	204789	296	204996	359	205297	155	205828	64
204580	51	204801	300	204998	301	205298	154	205828	66
204582	51	204802	300	204999	301	205299	155	205828	67
204583	51	204803	300	204999	353	205354	101	205828	68
204600	316	204804	300	205015	203	205454	95	205829	65
204601	316	204814	296	205032	176	205521	46	205829	68
204603	316	204815	296	205033	199	205604	142	205836	153
204608	282	204816	296	205034	199	205605	204	205851	5
204608	337	204817	296	205035	201	205611	84	205852	5
204609	282	204823	296	205036	200	205613	198	205853	5
204609	337	204831	296	205038	84	205614	198	205854	5
204612	280	204833	296	205042	140	205615	198	205865	189
204613	280	204837	296	205043	140	205616	198	205872	5
204616	280	204837	348	205044	84	205622	204	205873	5
204617	280	204839	296	205056	203	205625	146	205878	171
204621	290	204839	351	205060	204	205626	146	205879	171
204624	290	204840	296	205062	204	205631	204	205912	161
204624	342	204840	351	205064	204	205645	142	205915	172
204625	290	204841	296	205066	204	205654	15	205916	172
204625	342	204841	348	205073	176	205655	142	205917	172
204626	290	204842	296	205074	176	205671	54	205918	172
204627	223	204842	348	205075	176	205674	19	205923	75
204627	239	204854	296	205078	84	205679	145	205924	75
204628	223	204855	296	205101	124	205679	149	205937	3
204628	239	204864	295	205102	124	205680	146	205938	3
204636	223	204865	295	205106	2	205680	149	205940	14
204636	239	204866	295	205106	125	205684	154	205941	14
204642	280	204867	295	205139	44	205685	198	205944	1
204642	332	204883	232	205139	125	205686	198	205948	13
204643	280	204883	246	205141	36	205687	84	205952	50
204643	332	204884	232	205142	36	205688	11	205953	187
204650	280	204884	246	205143	36	205689	12	205954	187
204651	280	204889	296	205144	36	205694	161	205955	74
204654	291	204894	321	205145	36	205695	161	205955	76
204661	64	204904	301	205146	36	205696	161	205956	74
204666	280	204905	299	205147	36	205697	161	205956	76
204667	280	204905	351	205148	36	205708	72	205958	145
204676	299	204938	302	205149	36	205711	170	205962	145
204679	299	204938	354	205150	36	205712	170	205972	145
204681	299	204960	229	205151	36	205719	170	205975	145
204682	299	204960	246	205152	36	205722	205	205975	149
204710	285	204961	316	205160	83	205723	205	205981	101
204710	337	204962	316	205161	196	205727	13	206005	285
204711	285	204962	367	205162	198	205735	47	206005	338
204711	337	204968	316	205171	83	205761	172	206006	285



## NUMERICAL INDEX

Part No.	Page No.	Part No.	Page No.	Part No.	Page No.	Part No.	Page No.	Part No.	Page No.
206006	338	206080	65	206189	246	206480	289	206614	334
206007	285	206081	65	206189	325	206480	342	206614	385
206007	338	206086	312	206189	374	206481	223	206615	282
206008	285	206086	364	206192	219	206481	239	206615	334
206008	338	206090	291	206192	235	206481	289	206615	385
206009	285	206090	344	206192	279	206481	342	206616	282
206009	338	206118	300	206192	331	206482	223	206616	334
206010	285	206119	300	206193	219	206482	239	206616	385
206010	338	206130	253	206193	235	206482	290	206633	227
206011	305	206130	292	206193	279	206482	342	206633	243
206011	359	206130	344	206193	331	206483	223	206636	227
206012	305	206130	389	206193	409	206483	239	206636	243
206012	359	206132	292	206194	219	206483	290	206652	219
206013	305	206132	344	206194	235	206483	342	206652	235
206013	359	206132	389	206194	279	206484	290	206652	281
206014	312	206133	291	206194	331	206484	342	206652	333
206014	363	206133	344	206216	321	206492	224	206655	329
206015	312	206133	389	206216	372	206492	299	206655	380
206015	363	206134	291	206216	373	206493	224	206656	329
206016	312	206134	344	206217	292	206493	299	206656	380
206016	364	206134	389	206223	286	206500	224	206657	329
206017	338	206136	291	206223	338	206500	299	206657	380
206018	315	206136	344	206224	281	206503	224	206657	409
206018	364	206139	291	206224	333	206503	299	206696	305
206020	232	206139	344	206252	280	206514	302	206698	305
206020	249	206140	291	206253	280	206542	282	206706	280
206022	322	206140	344	206254	280	206542	334	206706	333
206023	325	206141	292	206255	280	206542	385	206709	395
206036	315	206141	344	206279	296	206543	282	206710	353
206036	364	206143	292	206295	285	206543	334	206710	395
206037	315	206143	344	206295	337	206543	385	206729	302
206037	364	206144	348	206296	285	206558	232	206729	354
206038	315	206173	285	206296	337	206558	246	206731	327
206038	364	206173	337	206301	51	206559	232	206731	379
206039	315	206174	285	206302	51	206559	246	206731	408
206039	367	206174	337	206303	51	206566	322	206734	326
206040	232	206175	285	206304	51	206566	374	206734	377
206040	246	206175	337	206305	51	206567	322	206735	326
206040	325	206176	285	206306	51	206567	374	206735	377
206040	374	206176	337	206454	300	206568	232	206737	326
206043	338	206177	285	206455	300	206568	249	206737	377
206049	296	206177	337	206462	302	206571	290	206739	326
206051	249	206178	285	206472	321	206571	342	206739	377
206054	286	206178	337	206476	223	206572	290	206744	289
206054	341	206179	285	206476	239	206572	342	206744	342
206055	286	206179	337	206476	289	206608	325	206744	412
206055	341	206180	285	206476	342	206608	377	206752	325
206056	286	206180	337	206477	223	206609	326	206752	374
206056	341	206181	285	206477	239	206609	377	206752	377
206057	286	206181	337	206477	289	206610	286	206753	325
206057	341	206182	285	206477	342	206610	338	206753	374
206060	51	206182	337	206478	289	206611	286	206753	377
206061	51	206187	252	206478	342	206611	341	206754	374
206074	316	206187	286	206479	223	206612	286	206834	232
206074	368	206187	338	206479	239	206612	341	206834	246
206075	316	206188	286	206479	289	206613	282	206869	285
206075	368	206188	338	206479	342	206613	334	206869	337
206076	64	206188	400	206480	223	206613	385	206886	305
206078	64	206189	232	206480	239	206614	282	206886	359

## NUMERICAL INDEX

Part No.	Page No.	Part No.	Page No.	Part No.	Page No.	Part No.	Page No.	Part No.	Page No.
206887	305	207394	53	207731	101	209034	31	209200	192
206887	359	207397	186	207741	15	209034	64	209201	192
206906	282	207404	203	207744	15	209035	185	209209	139
206906	337	207405	203	207745	24	209035	34	209222	58
206908	282	207409	53	207748	22	209038	35	209223	58
206908	337	207410	53	207750	1	209038	74	209226	178
206909	282	207415	187	207750	18	209039	34	209227	178
206909	337	207416	56	207750	160	209039	35	209228	178
206911	282	207417	56	207750	179	209039	74	209229	178
206911	337	207423	187	207750	183	209050	34	209237	205
206913	328	207432	187	207751	24	209050	44	209238	205
206913	380	207437	187	207753	16	209053	1	209246	138
206919	253	207477	30	207754	26	209054	97	209247	138
206919	343	207477	31	207761	15	209055	2	209250	205
206920	253	207477	34	207762	18	209056	1	209251	205
206920	343	207477	35	207771	22	209058	185	209263	206
206921	343	207478	161	207773	125	209065	141	209265	34
207013	30	207482	161	207776	18	209066	141	209265	75
207013	43	207518	150	207800	34	209068	142	209266	34
207013	179	207520	83	207800	35	209069	142	209266	75
207040	10	207525	83	207800	38	209070	109	209291	177
207041	22	207530	142	207800	69	209072	98	209292	177
207058	22	207536	147	207800	72	209073	115	209293	177
207060	15	207536	150	207803	69	209075	1	209302	146
207102	186	207542	139	207804	101	209083	170	209303	146
207175	4	207544	47	207806	68	209094	34	209306	146
207176	130	207559	13	207807	66	209094	44	209308	74
207181	5	207560	13	207815	133	209097	49	209309	146
207182	3	207561	13	207816	133	209098	48	209310	146
207183	3	207562	13	207818	138	209099	31	209322	74
207196	5	207582	47	207819	17	209099	67	209323	74
207208	155	207582	133	207827	15	209109	35	209324	74
207209	155	207637	178	207828	66	209109	34	209332	110
207210	155	207638	178	207828	71	209109	40	209336	161
207211	155	207639	178	207829	66	209110	41	209339	110
207212	15	207640	178	207829	71	209113	145	209347	44
207213	15	207648	16	207830	110	209116	83	209357	145
207235	22	207649	68	207880	46	209121	34	209364	172
207235	28	207651	139	207884	170	209121	44	209365	172
207239	175	207657	139	207905	47	209122	18	209366	172
207239	177	207661	139	207906	4	209124	15	209367	172
207246	79	207666	58	207925	48	209125	18	209375	55
207286	146	207671	57	207926	48	209126	18	209376	55
207286	149	207674	17	207935	47	209128	17	209387	55
207288	138	207675	17	207954	46	209131	67	209390	3
207299	3	207681	95	207980	185	209154	79	209391	3
207300	3	207682	17	207981	185	209161	145	209394	31
207304	3	207683	17	207982	185	209163	40	209394	42
207305	3	207685	17	207983	185	209172	195	209395	31
207318	4	207686	17	207984	185	209173	60	209395	42
207319	4	207697	68	207994	97	209174	201	209403	75
207324	64	207714	16	207998	30	209188	153	209404	75
207326	80	207715	16	209007	161	209190	138	209421	19
207327	204	207723	15	209007	164	209191	138	209422	49
207332	206	207725	15	209015	82	209194	191	209440	49
207339	203	207726	15	209024	185	209196	192	209441	49
207382	204	207730	34	209027	36	209197	192	209444	203
207384	110	207730	35	209027	70	209198	192	209453	232
207392	53	207730	101	209028	12	209199	192	209453	246

## NUMERICAL INDEX

Part No.	Page No.	Part No.	Page No.	Part No.	Page No.	Part No.	Page No.	Part No.	Page No.
209453	325	209637	31	209909	64	210168	68	210323	192
209453	377	209645	46	209910	180	210170	66	210334	192
209456	183	209655	165	209912	50	210172	66	210346	189
209459	4	209656	158	209913	50	210174	66	210358	175
209460	4	209660	146	209917	17	210175	67	210371	187
209461	43	209680	5	209918	64	210183	145	210404	187
209463	31	209681	17	209919	64	210184	145	210408	19
209463	35	209684	74	209925	64	210196	183	210408	21
209463	43	209687	160	209926	186	210196	186	210423	203
209463	183	209694	42	209930	16	210197	183	210434	171
209482	172	209704	34	209940	64	210197	186	210435	172
209484	46	209704	35	209950	16	210207	16	210454	41
209486	187	209704	38	209951	16	210212	187	210469	31
209499	146	209704	125	209952	203	210220	16	210469	42
209501	34	209709	172	209984	16	210224	16	210470	31
209501	44	209710	172	209985	16	210227	125	210470	42
209502	34	209713	101	209987	17	210231	125	210473	153
209502	44	209713	128	209996	174	210234	34	210481	153
209504	186	209717	159	209996	177	210237	64	210490	159
209505	146	209722	74	210000	174	210239	84	210513	159
209512	232	209723	74	210000	177	210243	84	210562	175
209512	246	209726	75	210001	16	210245	84	210562	177
209512	325	209727	159	210002	16	210249	57	210608	67
209512	374	209738	158	210033	47	210250	57	210619	69
209518	24	209741	159	210035	47	210251	57	210639	29
209520	24	209742	45	210039	17	210252	57	210644	29
209524	155	209747	186	210040	16	210257	58	210649	29
209524	156	209751	182	210041	16	210258	58	210654	57
209525	155	209754	26	210042	16	210259	58	210656	25
209525	156	209762	159	210043	16	210260	31	210657	25
209527	183	209766	174	210045	158	210260	57	210676	28
209533	109	209766	177	210046	158	210261	57	210684	24
209542	44	209773	203	210047	50	210272	31	210691	203
209543	182	209775	46	210049	171	210272	66	210692	203
209544	182	209781	186	210050	17	210276	16	210720	49
209562	175	209785	145	210052	17	210277	16	210721	49
209562	177	209786	145	210053	184	210278	15	210733	15
209568	175	209812	203	210058	153	210279	159	210734	15
209572	182	209842	159	210066	17	210280	16	210755	158
209578	232	209850	183	210068	18	210281	16	210759	205
209578	246	209851	23	210070	68	210282	16	210765	205
209578	325	209851	45	210070	232	210283	16	210776	16
209578	377	209851	69	210070	246	210288	23	210797	72
209579	232	209851	72	210070	256	210297	3	210804	185
209579	249	209851	76	210070	325	210297	6	210808	17
209579	325	209852	16	210070	374	210298	34	210809	205
209579	377	209853	182	210070	407	210298	35	210810	205
209584	158	209856	16	210097	1	210298	97	210811	1
209585	158	209858	36	210097	186	210299	31	210914	1
209609	159	209858	38	210119	28	210299	57	210816	172
209611	58	209858	70	210121	146	210302	192	210817	4
209613	158	209867	158	210121	149	210305	192	210827	184
209614	158	209877	203	210126	64	210306	192	210829	26
209615	158	209893	13	210155	31	210307	192	210833	41
209620	4	209898	13	210155	64	210308	192	210834	68
209623	5	209899	13	210159	31	210309	16	210862	43
209628	5	209903	64	210159	66	210310	192	210865	75
209629	4	209907	64	210162	68	210319	195	210877	28
209636	16	209908	64	210166	67	210322	195	210879	184

## NUMERICAL INDEX

Part No.	Page No.	Part No.	Page No.	Part No.	Page No.	Part No.	Page No.	Part No.	Page No.
210880	185	211171	409	211434	326	211930	380	212144	321
210882	185	211191	251	211434	377	211931	233	212145	321
210886	35	211191	384	211503	296	211931	250	212146	321
210886	179	211191	396	211504	296	211931	329	212151	317
210886	184	211205	6	211510	317	211931	380	212156	52
210887	185	211207	316	211511	317	211932	233	212157	306
210888	185	211207	368	211525	317	211932	250	212157	360
210889	185	211211	281	211537	317	211932	329	212158	305
210890	28	211213	281	211538	317	211932	380	212159	305
210892	184	211214	281	211539	252	211963	228	212160	296
210893	185	211215	300	211539	389	211963	245	212161	296
210895	184	211216	300	211539	393	211964	228	212168	286
210896	82	211245	224	211540	317	211964	245	212168	338
210897	82	211245	243	211541	317	211965	228	212170	318
210898	82	211246	227	211542	317	211965	245	212170	372
210899	82	211246	243	211543	317	211966	228	212171	318
210900	82	211247	223	211548	296	211966	245	212171	372
210901	82	211247	239	211549	296	212038	305	212173	281
210902	82	211259	223	211587	317	212040	333	212173	333
210903	82	211259	239	211588	317	212043	286	212203	296
210904	82	211262	224	211596	318	212043	341	212204	296
210905	82	211262	243	211597	318	212044	286	212205	316
210906	82	211263	224	211635	318	212044	341	212206	316
210907	82	211263	243	211648	394	212045	290	212207	316
210908	82	211290	223	211649	317	212045	342	212208	316
210909	82	211290	239	211649	402	212047	291	212209	316
210910	82	211292	223	211649	405	212048	291	212210	316
210911	82	211292	239	211650	321	212049	296	212212	321
210912	1	211295	232	211668	321	212049	348	212213	321
210915	25	211295	246	211668	372	212050	296	212214	322
210936	29	211295	322	211675	317	212050	351	212215	322
210939	28	211295	374	211682	322	212052	348	212216	322
210940	25	211296	223	211683	322	212057	299	212217	322
210943	1	211296	239	211695	296	212058	299	212224	223
210951	28	211297	223	211696	296	212078	317	212224	239
210959	29	211297	239	211697	322	212079	317	212244	326
210962	29	211377	291	211698	322	212080	317	212244	377
210964	29	211377	343	211715	296	212083	318	212257	318
210965	29	211377	388	211716	296	212084	318	212259	318
211003	387	211391	326	211760	317	212088	325	212274	372
211026	384	211392	327	211784	52	212094	305	212280	311
211055	325	211393	326	211785	52	212095	305	212280	363
211055	377	211394	327	211786	52	212096	316	212280	399
211056	232	211397	326	211787	52	212096	367	212281	312
211056	249	211398	327	211788	52	212102	321	212281	363
211057	232	211402	317	211789	52	212102	372	212283	301
211057	249	211409	317	211790	52	212103	321	212283	353
211058	325	211409	321	211806	333	212103	372	212290	318
211058	377	211409	371	211809	394	212106	318	212294	312
211059	232	211409	402	211875	302	212107	318	212295	312
211059	249	211409	406	211879	302	212121	317	212297	312
211167	290	211414	317	211889	290	212122	317	212297	363
211168	290	211414	322	211894	318	212123	317	212298	312
211168	342	211426	317	211895	318	212124	317	212298	363
211169	290	211426	321	211896	321	212132	318	212299	312
211170	290	211429	296	211897	321	212133	318	212299	363
211170	342	211430	296	211930	233	212134	318	212304	312
211171	328	211432	317	211930	250	212135	318	212304	363
211171	380	211433	317	211930	329	212143	321	212304	399

## NUMERICAL INDEX

Part No.	Page No.	Part No.	Page No.	Part No.	Page No.	Part No.	Page No.	Part No.	Page No.
212310	311	212399	306	212436	363	212596	371	212972	347
212318	325	212399	360	212436	399	212602	254	212974	363
212318	374	212400	311	212941	363	212602	343	212975	363
212324	312	212400	360	212456	325	212602	394	212976	351
212324	363	212401	311	212456	374	212610	352	212978	243
212325	311	212401	360	212457	325	212611	352	212979	351
212326	52	212402	285	212457	374	212612	353	212979	348
212330	321	212402	337	212458	325	212619	378	212981	243
212340	291	212403	285	212458	374	212620	378	212984	351
212340	343	212403	337	212459	325	212633	343	212986	351
212341	291	212404	285	212459	374	212654	253	212991	351
212341	343	212404	337	212460	325	212659	367	212993	243
212342	291	212405	285	212460	374	212661	368	212993	351
212342	343	212405	337	212468	285	212662	368	212995	351
212343	291	212406	285	212468	337	212671	372	212997	243
212343	343	212406	337	212480	373	212676	249	212997	351
212364	51	212407	285	212483	373	212677	249	213008	28
212365	318	212407	337	212490	371	212690	240	213014	44
212366	402	212408	306	212490	402	212690	344	213029	187
212366	405	212408	360	212490	405	212691	240	213035	201
212369	396	212409	306	212494	51	212691	344	213036	201
212370	295	212409	363	212495	51	212695	240	213037	201
212374	327	212410	306	212496	51	212695	344	213039	201
212374	379	212410	360	212497	51	212706	367	213040	201
212376	347	212411	312	212498	51	212709	344	213041	201
212377	347	212416	318	212499	51	212711	344	213042	201
212379	343	212416	368	212500	51	212713	401	213043	200
212380	306	212417	318	212501	51	212760	64	213044	201
212380	360	212417	368	212502	51	212783	64	213045	201
212381	306	212420	299	212503	51	212786	64	213046	201
212381	360	212420	351	212504	51	212799	363	213052	199
212382	316	212421	299	212505	51	212800	351	213053	199
212383	317	212421	351	212506	51	212801	351	213054	201
212384	317	212422	299	212507	51	212802	351	213055	201
212385	317	212422	351	212524	373	212803	351	213056	29
212386	317	212423	299	212526	371	212808	351	213056	69
212387	318	212423	351	212531	371	212809	351	213056	72
212388	306	212424	299	212532	371	212812	351	213058	58
212388	360	212424	351	212533	325	212813	351	213136	29
212389	306	212425	299	212533	374	212814	351	213137	146
212389	360	212425	351	212534	371	212815	351	213138	146
212390	285	212427	311	212535	371	212824	351	213142	56
212390	337	212428	290	212539	371	212825	351	213145	56
212391	285	212428	342	212540	371	212848	253	213146	56
212391	337	212429	290	212541	371	212848	347	213164	165
212392	311	212429	342	212544	371	212848	391	213171	29
212392	360	212430	290	212551	371	212849	253	213172	135
212393	311	212430	342	212552	371	212849	347	213173	185
212393	360	212431	290	212553	371	212849	391	213179	165
212394	311	212431	342	212554	371	212852	377	213186	17
212394	360	212432	311	212555	318	212854	373	213196	50
212395	311	212432	363	212557	371	212875	348	213203	46
212395	360	212433	301	212558	371	212876	348	213213	67
212396	306	212434	306	212564	322	212877	351	213240	180
212396	360	212434	359	212564	374	212878	243	213247	75
212397	306	212435	312	212565	322	212878	351	213248	75
212397	360	212435	363	212565	374	212879	351	213249	75
212398	306	212435	399	212590	343	212968	348	213254	75
212398	360	212436	312	212595	371	212969	348	213258	75



## NUMERICAL INDEX

Part No.	Page No.	Part No.	Page No.	Part No.	Page No.	Part No.	Page No.	Part No.	Page No.
213261	74	213438	183	213826	68	214054	328	214461	373
213262	74	213448	16	213830	68	214054	380	214474	353
213263	74	213449	16	213832	35	214054	409	214481	368
213264	75	213463	147	213832	64	214186	378	214483	332
213265	75	213463	150	213833	176	214211	381	214484	332
213266	75	213468	187	213836	66	214212	381	214485	332
213267	75	213469	25	213839	67	214213	381	214486	332
213268	75	213477	142	213840	65	214213	410	214494	332
213269	74	213478	142	213843	66	214236	378	214495	332
213270	74	213493	125	213845	66	214237	378	214496	332
213300	182	213505	125	213851	66	214238	378	214497	332
213302	182	213539	204	213853	66	214239	378	214498	373
213303	182	213540	204	213856	65	214240	378	214499	377
213305	182	213541	204	213856	68	214241	378	214510	351
213306	182	213567	147	213864	68	214246	342	214511	351
213307	182	213629	54	213868	67	214247	342	214523	332
213308	182	213675	325	213870	66	214250	378	214531	354
213309	182	213675	377	213871	66	214251	378	214532	354
213310	182	213692	282	213872	68	214252	378	214561	292
213311	182	213695	282	213886	35	214253	378	214561	344
213312	182	213698	282	213886	68	214258	342	214562	381
213313	182	213702	282	213900	161	214259	342	214562	410
213315	182	213703	282	213901	161	214276	378	214563	354
213316	182	213706	282	213902	101	214277	378	214565	372
213316	186	213708	282	213909	199	214278	378	214569	368
213317	186	213712	282	213909	201	214279	378	214584	353
213320	186	213714	282	213910	199	214280	379	214587	353
213322	186	213715	282	213910	201	214282	342	214590	353
213325	183	213716	282	213911	58	214296	379	214591	352
213325	186	213719	282	213919	58	214301	351	214592	352
213326	66	213722	282	213921	75	214302	351	214599	343
213327	183	213725	282	213922	75	214310	371	214604	352
213328	183	213727	282	213923	58	214311	371	214605	352
213330	183	213728	282	213926	75	214311	373	214606	352
213331	183	213730	282	213927	75	214313	348	214607	352
213332	183	213732	282	213932	48	214316	351	214615	353
213338	69	213734	282	213936	96	214317	351	214616	353
213338	72	213736	282	213938	138	214319	348	214617	353
213340	69	213762	58	213946	53	214323	348	214620	354
213340	72	213768	58	213947	53	214324	348	214621	372
213347	57	213769	57	213962	201	214330	371	214622	372
213348	76	213770	57	213963	201	214331	371	214644	347
213349	76	213772	57	213964	201	214369	348	214645	347
213350	76	213773	57	213965	201	214370	348	214650	347
213351	76	213787	57	213966	201	214371	351	214651	347
213363	51	213805	35	213967	201	214372	351	214655	372
213372	24	213805	36	213968	201	214376	371	214658	343
213374	26	213805	43	213969	201	214378	379	214663	347
213377	26	213807	20	213970	201	214378	409	214665	347
213378	26	213807	21	213971	201	214379	368	214670	347
213379	26	213808	20	213972	201	214380	368	214671	347
213380	26	213808	21	213973	201	214390	343	214680	348
213381	26	213809	19	213974	201	214397	351	214686	372
213382	26	213810	189	213975	201	214443	354	214688	372
213383	26	213814	188	213992	76	214444	354	214689	378
213384	26	213818	158	213898	161	214446	368	214690	378
213387	24	213819	158	214109	409	214446	372	214697	344
213403	147	213821	203	214054	233	214446	373	214698	347
213437	186	213825	68	214054	249	214447	354	214712	332

## NUMERICAL INDEX

Part No.	Page No.	Part No.	Page No.	Part No.	Page No.	Part No.	Page No.	Part No.	Page No.
214712	359	214890	352	215184	56	215506	76	215715	155
214713	348	214891	352	215187	56	215507	41	215716	154
214714	348	214892	352	215217	18	215509	183	215717	155
214715	371	214894	65	215221	17	215515	36	215730	156
214716	371	214895	65	215241	55	215547	68	215731	156
214717	347	214901	401	215242	55	215547	71	215739	48
214727	344	214906	332	215243	54	215563	19	215740	48
214729	347	214907	332	215248	56	215566	19	215741	47
214729	391	214911	333	215249	56	215573	198	215743	48
214730	347	214951	378	215252	56	215574	198	215744	48
214730	391	214952	378	215254	56	215580	35	215765	46
214741	377	214974	236	215255	58	215580	43	215778	46
214742	368	214974	411	215268	53	215581	35	215779	46
214743	368	214983	348	215269	53	215581	43	215791	359
214744	371	214986	51	215287	53	215584	155	215792	359
214745	371	214987	51	215288	53	215585	155	215795	41
214748	373	214988	51	215295	3	215586	155	215798	3
214750	373	214989	51	215296	3	215587	155	215800	156
214753	354	215000	172	215314	5	215591	31	215801	156
214760	367	215001	20	215315	5	215591	35	215825	145
214762	367	215002	19	215318	3	215591	44	215844	68
214764	367	215003	68	215319	3	215592	46	215844	71
214768	354	215010	35	215320	5	215593	46	215846	171
214770	354	215010	75	215321	5	215594	47	215850	36
214772	354	215011	35	215349	114	215595	46	215850	44
214779	372	215011	75	215350	115	215596	46	215851	35
214809	378	215016	35	215351	40	215597	47	215851	42
214813	347	215016	57	215352	40	215618	46	215852	35
214814	347	215022	182	215353	40	215620	170	215852	42
214819	341	215034	180	215356	54	215621	170	215853	35
214820	341	215040	192	215358	49	215622	170	215853	42
214821	341	215049	65	215359	49	215623	170	215854	35
214822	341	215049	66	215367	55	215624	170	215854	42
214823	341	215049	68	215368	55	215648	18	215880	186
214824	341	215050	36	215371	35	215648	27	215899	5
214825	341	215050	184	215371	38	215648	28	215900	5
214826	341	215061	192	215371	189	215649	18	215903	5
214327	344	215062	204	215372	53	215658	198	215904	5
214833	344	215084	189	215373	53	215669	156	215927	132
214841	381	215085	5	215383	35	215672	47	215947	130
214842	368	215086	4	215383	67	215673	156	215977	160
214849	347	215087	4	215384	38	215674	156	215977	163
214851	347	215090	148	215384	66	215677	35	215991	170
214862	378	215091	142	215384	70	215677	40	215992	170
214863	378	215091	148	215385	67	215692	19	215993	173
214866	332	215099	130	215386	35	215693	19	215999	170
214867	332	215100	129	215392	66	215694	19	216100	43
214869	373	215101	189	215393	66	215696	19	216101	183
214870	373	215104	129	215397	67	215696	21	216111	170
214871	373	215105	56	215398	67	215697	19	216115	184
214872	373	215108	185	215400	4	215697	21	216122	203
214873	373	215110	129	215472	129	215700	19	216134	35
214874	373	215136	49	215483	130	215700	21	216138	130
214882	333	215137	49	215489	130	215703	156	216143	42
214883	334	215138	1	215495	183	215704	155	216164	130
214884	333	215139	195	215497	186	215705	155	216190	129
214887	354	215163	5	215498	182	215707	155	216202	124
214888	354	215177	110	215503	182	215708	155	216204	41
214889	333	215183	57	215506	35	215714	154	216208	189

## NUMERICAL INDEX

Part No.	Page No.	Part No.	Page No.	Part No.	Page No.	Part No.	Page No.	Part No.	Page No.
216220	5	216907	49	218431	338	219010	101	219892	128
216222	182	216915	155	218432	286	219011	101	219893	115
216235	131	216915	157	218432	338	219023	186	219894	126
216266	46	216927	67	218433	286	219027	45	219894	127
216287	129	216927	70	218433	338	219050	110	219895	115
216288	66	216945	41	218434	286	219065	126	219899	161
216320	130	216946	189	218434	338	219121	189	219903	128
216340	129	216983	161	218435	286	219134	203	219904	128
216345	50	216991	20	218435	338	219165	68	219906	126
216346	50	216994	161	218436	343	219165	71	219907	130
216347	50	216996	161	218437	343	219203	68	219909	130
216371	182	215998	161	218438	343	219208	195	219909	129
216372	186	218045	378	218439	348	219209	154	219919	128
216375	130	218047	378	218440	348	219215	46	219920	129
216377	130	218051	378	218441	348	219254	141	219921	141
216378	130	218060	378	218442	348	219312	67	219932	189
216389	97	218169	409	218443	348	219312	71	219933	149
216436	130	218170	409	218444	348	219331	84	219938	126
216448	129	218176	410	218445	363	219335	24	219939	126
216449	130	218178	410	218446	363	219336	24	219947	125
216452	95	218181	410	218447	363	219338	24	219948	98
216496	126	218183	410	218448	363	219457	172	219949	24
216496	127	218186	410	218449	363	219458	172	219952	126
216548	178	218188	410	218450	368	219518	14	219954	70
216549	55	218198	410	218451	368	219524	152	219955	126
216549	178	218305	337	218452	368	219525	152	219956	126
216559	203	218305	385	218453	368	219526	152	219957	141
216610	76	218306	337	218454	368	219559	5	219958	141
216611	76	218308	363	218455	368	219561	5	219959	141
216613	76	218310	371	218456	368	219563	5	219960	126
216615	76	218310	373	218457	371	219565	5	219961	126
216616	76	218332	52	218458	372	219566	4	219967	140
216617	76	218337	333	218460	367	219567	4	219968	140
216618	76	218356	341	218461	367	219591	140	219969	140
216631	141	218357	341	218462	367	219594	95	219970	126
216655	58	218371	334	218464	367	219663	26	219979	4
216655	63	218373	334	218468	367	219671	24	219981	201
216678	131	218374	334	218469	367	219673	24	219985	201
216679	131	218377	334	218474	367	219704	98	219986	201
216680	131	218378	334	218475	367	219712	126	219997	139
216681	131	218381	334	218476	368	219712	127	220075	182
216684	131	218382	334	218501	341	219716	184	220513	400
216685	131	218388	334	218503	368	219724	35	220526	404
216747	58	218389	334	218522	392	219724	115	220527	404
216751	58	218390	334	218525	398	219737	109	220528	404
216812	196	218391	334	218600	386	219745	176	220529	404
216816	196	218392	334	218655	374	219803	109	220530	404
216838	183	218397	334	218685	337	219810	84	220534	393
216842	184	218398	334	218685	385	219815	129	220535	393
216843	185	218399	334	218757	342	219820	141	220536	393
216845	184	218404	367	218758	342	229822	389	220537	393
216847	194	218405	368	218759	348	219846	129	220539	393
216849	101	218406	368	218786	368	219857	130	220556	393
216851	98	218407	368	218823	38	219863	27	220557	393
216852	98	218411	368	218823	76	219877	27	220560	405
216859	180	218412	368	218824	76	219880	128	220562	405
216882	131	218430	286	218835	343	219882	128	220565	405
216887	68	218430	338	218836	343	219885	130	220571	405
216887	71	218431	286	218875	333	219889	130	220572	405
						219891	129		

## NUMERICAL INDEX

Part No.	Page No.	Part No.	Page No.	Part No.	Page No.	Part No.	Page No.	Part No.	Page No.
220573	405	220718	255	220932	388	221405	187	223007	53
220574	405	220718	399	220941	251	221406	187	223017	48
220576	406	220719	255	220942	251	221409	71	223018	164
220579	405	220719	399	220960	255	221413	126	223019	164
220580	406	220723	255	220960	400	221413	127	223020	164
220582	406	220723	399	220961	255	221414	126	223066	133
220583	406	220726	255	220961	400	221415	126	223079	128
220587	406	220726	399	220962	255	221415	127	223103	6
220588	406	220734	255	220962	400	221438	185	223115	139
220600	402	220734	399	220963	255	221459	125	223117	40
220600	405	220735	255	220963	400	221484	48	223123	27
220601	403	220735	399	220972	401	221498	98	223127	38
220602	403	220746	393	220977	391	221499	125	223127	133
220603	403	220747	393	220978	52	221509	13	223135	149
220604	403	220750	70	220979	390	221545	27	223142	408
220618	402	220761	76	220980	252	221573	49	223148	164
220620	401	220761	388	220982	52	221574	49	223152	150
220621	404	220761	387	220983	51	221577	80	223153	150
220622	403	220769	252	220988	384	221580	128	223187	186
220624	402	220769	388	221000	70	221581	128	223193	48
220625	402	220771	252	221002	70	221582	128	223197	148
220626	403	220772	252	221003	114	221584	128	223198	187
220627	403	220773	252	221004	114	221589	128	223199	183
220628	403	220780	255	221005	141	221629	187	223204	24
220629	403	220780	400	221006	110	221640	7	223212	60
220634	402	220784	255	221010	126	221677	201	223222	60
220633	402	220784	400	221010	129	221678	201	223223	60
220635	403	220797	253	221011	38	221707	54	223225	59
220636	404	220797	391	221011	101	221718	154	223226	59
220640	403	220814	394	221014	125	221719	154	223231	60
220641	402	220816	394	221016	125	221720	152	223236	148
220642	402	220817	394	221035	139	221721	164	223237	59
220643	406	220818	394	221040	83	221724	164	223238	59
220644	406	220820	394	221042	115	221725	164	223241	59
220650	402	220844	407	221043	126	221726	164	223242	148
220651	402	220845	408	221061	71	221728	54	223243	47
220652	401	220846	408	221064	126	221745	22	223264	146
220653	401	220847	408	221065	24	221746	22	223265	148
220654	403	220849	407	221066	26	221786	166	223271	138
220660	405	220850	407	221076	142	221786	174	223277	164
220661	405	220851	406	221084	142	221786	177	223302	148
220662	405	220852	406	221086	98	221788	174	223308	56
220663	405	220853	406	221125	128	221788	177	223309	56
220687	251	220854	406	221169	128	221813	24	223311	55
220688	251	220855	406	221174	126	221850	27	223312	38
220689	403	220859	407	221204	97	221858	175	223312	78
220693	403	220860	407	221205	97	221859	175	223313	38
220694	403	220865	70	221233	149	221869	24	223313	78
220695	403	220872	405	221253	24	221871	47	223315	55
220695	406	220873	70	221260	25	221872	24	223323	182
220696	404	220874	70	221278	15	221881	173	223325	180
220696	405	220878	70	221279	15	221950	101	223329	6
220697	405	220878	390	221283	25	221951	101	223331	126
220698	403	220879	70	221287	22	221953	148	223334	55
220706	405	220879	390	221290	153	221978	148	223340	139
220711	255	220883	392	221369	97	221981	148	223341	59
220711	399	220924	405	221376	126	222510	96	223345	139
220717	255	220925	405	221381	97	222511	96	223346	139
220717	399	220932	253	221388	1	223005	53	223347	128

## NUMERICAL INDEX

Part No.	Page No.	Part No.	Page No.	Part No.	Page No.	Part No.	Page No.	Part No.	Page No.
223348	128	223555	189	223779	97	223920	72	224123	251
223370	185	223556	54	223784	36	223921	36	224123	384
223377	178	223563	7	223784	70	223921	69	224124	251
223378	178	223564	7	223789	71	223922	36	224124	384
223381	55	223565	55	223800	14	223922	71	224129	404
223382	182	223573	1	223801	14	223924	38	224130	391
223383	148	223574	1	223802	14	223924	40	224131	391
223415	183	223575	78	223804	14	223925	157	224132	390
223417	182	223576	78	223805	14	223933	71	224133	390
223429	53	223577	78	223807	13	223934	163	224137	401
223430	53	223587	7	223810	13	223935	162	224150	384
223432	6	223588	16	223811	14	223936	162	224154	253
223433	6	223601	19	223812	14	223937	162	224154	388
223437	6	223601	20	223815	14	223940	71	224157	385
223438	6	223602	19	223818	14	223942	27	224163	388
223443	6	223602	20	223822	156	223946	55	224169	252
223444	6	223605	20	223826	36	223947	55	224169	386
223446	53	223605	21	223826	59	223950	71	224170	252
223447	204	223608	20	223830	163	223959	206	224170	386
223450	203	223608	21	223831	14	223965	206	224171	252
223451	204	223612	15	223839	41	223966	206	224171	386
223454	54	223616	14	223843	59	223971	157	224172	385
223455	54	223616	163	223844	173	223972	157	224180	404
223461	148	223617	162	223845	173	223975	157	224183	255
223470	53	223620	163	223846	173	223976	157	224183	399
223471	53	223621	164	223847	173	223978	77	224213	404
223472	148	223622	162	223849	173	223980	97	224214	404
223473	7	223624	163	223861	162	223982	199	224227	404
223473	148	223625	163	223863	162	223984	199	224230	401
223480	6	223626	163	223864	19	223986	199	224237	401
223481	6	223627	18	223864	21	223993	157	224246	394
223482	147	223628	15	223866	19	223994	157	224254	393
223483	55	223630	157	223866	20	223997	157	224262	251
223484	55	223631	157	223866	21	223998	157	224262	384
223485	173	223632	157	223870	162	224064	253	224263	251
223485	174	223633	157	223871	162	224064	388	224263	384
223486	173	223648	13	223873	162	224065	253	224265	387
223487	174	223649	13	223874	162	224065	388	224287	252
223490	19	223652	13	223876	97	224068	389	224302	253
223490	20	223659	38	223878	157	224071	401	224302	391
223491	20	223659	71	223879	157	224075	394	224303	391
223492	79	223683	27	223881	41	224082	394	224304	409
223493	19	223696	162	223882	41	224088	386	224307	252
223493	20	223696	166	223886	41	224089	386	224308	252
223499	38	223697	162	223887	41	224090	386	224309	401
223499	115	223697	166	223889	38	224100	386	224310	401
223500	53	223702	162	223889	72	224101	386	224317	252
223503	149	223702	166	223896	13	224102	386	224318	252
223504	149	223703	162	223897	13	224103	386	224331	394
223505	198	223703	166	223902	16	224104	386	224332	394
223506	198	223713	184	223903	18	224105	386	224342	401
223507	199	223740	148	223905	156	224106	386	224343	401
223508	199	223747	115	223906	156	224107	386	224380	383
223509	199	223754	49	223908	50	224115	401	224381	383
223512	199	223755	49	223909	163	224116	70	224382	383
223532	198	223759	36	223914	27	224117	70	224383	383
223533	53	223759	44	223917	27	224118	393	224384	383
223534	53	223761	173	223919	38	224119	405	224385	383
223538	55	223762	173	223919	97	224121	385	224392	401



## NUMERICAL INDEX

Part No.	Page No.	Part No.	Page No.	Part No.	Page No.	Part No.	Page No.	Part No.	Page No.
224411	401	224566	389	224763	394	225014	6	225272	80
224415	410	224569	392	224781	404	225018	173	225273	80
224416	410	224570	392	224789	394	225018	174	225274	184
224426	407	224573	253	224790	394	225018	175	225275	52
224432	404	224574	389	224793	394	225062	98	225276	83
224435	406	224575	392	224794	394	225063	98	225279	38
224437	387	224576	392	224805	406	225064	131	225279	184
224440	387	224577	392	224806	406	225065	131	225289	83
224442	387	224578	392	224810	393	225066	131	225292	82
224452	254	224579	392	224811	393	225067	131	225293	80
224458	401	224580	392	224819	394	225068	131	225294	49
224459	401	224587	392	224824	404	225069	131	225295	49
224462	401	224588	392	224828	400	225071	131	225297	80
224463	401	224597	254	224831	396	225073	131	225299	47
224476	387	224597	388	224835	399	225083	46	225307	38
224488	394	224597	397	224838	400	225087	199	225307	43
224489	394	224598	387	224840	400	225107	189	225308	38
224490	394	224600	388	224844	393	225134	150	225308	43
224491	384	224601	400	224845	393	225140	7	225309	38
224492	384	224621	69	224846	393	225141	7	225312	80
224509	384	224628	206	224847	393	225148	407	225315	83
224509	396	224629	384	224848	393	225149	77	225319	13
224512	384	224636	391	224849	393	225151	36	225348	83
224513	384	224638	391	224850	393	225151	38	225351	6
224521	392	224647	251	224851	393	225151	72	225353	126
224523	388	224647	384	224852	406	225156	72	225355	126
224530	395	224651	388	224853	406	225158	6	225375	45
224531	392	224652	52	224854	404	225159	6	225376	42
224534	389	224653	51	224856	387	225160	50	225377	42
224535	396	224654	52	224857	404	225162	36	225381	42
224536	396	224655	52	224858	405	225162	42	225385	27
224537	253	224656	206	224877	404	225163	36	225386	44
224537	389	224668	407	224878	404	225163	42	225386	38
224539	252	224669	406	224885	52	225183	71	225387	38
224540	403	224670	406	224886	52	225188	192	225387	44
224542	402	224672	384	224887	386	225190	71	225393	7
224542	406	224679	384	224905	400	225190	72	225394	7
224543	403	224688	396	224909	400	225202	96	225395	41
224543	404	224691	399	224910	400	225203	96	225396	38
224543	405	224692	399	224911	402	225204	96	225397	149
224543	406	224700	398	224918	394	225205	96	225404	27
224544	402	224704	392	224936	404	225206	96	225406	18
224544	406	224705	392	224948	392	225207	96	225408	206
224547	403	224710	392	224952	384	225208	96	225410	27
224547	404	224711	392	224957	404	225209	96	225415	45
224547	406	224713	392	224961	395	225248	15	225416	28
224548	253	224714	396	224973	400	225250	71	225417	28
224549	253	224715	393	224984	392	225250	97	225418	149
224550	388	224716	395	224985	392	225252	71	225430	149
224554	388	224717	395	224991	393	225253	71	225431	149
224555	389	224718	395	224994	383	225255	50	225432	149
224558	389	224719	395	224995	383	225256	50	225440	7
224559	254	224725	393	224996	396	225259	50	225445	164
224559	388	224728	393	224997	396	225261	43	225447	163
224559	397	224729	393	224999	384	225262	43	225448	164
224560	387	224730	390	225005	71	225263	43	225449	164
224561	387	224744	396	225007	69	225264	43	225454	71
224562	389	224754	391	225007	72	225270	80	225468	6
224565	393	224755	391	225013	6	225271	80	225479	27

## NUMERICAL INDEX

Part No.	Page No.	Part No.	Page No.	Part No.	Page No.	Part No.	Page No.	Part No.	Page No.
225482	27	225746	63	225955	49	226263	388	226653	411
225490	14	225748	77	225957	206	226267	393	226654	411
225493	60	225756	38	225958	77	226269	400	226655	411
225499	50	225756	77	225961	77	226273	405	226690	411
225500	149	225778	206	225962	77	226274	405	226691	411
225505	7	225804	188	225965	77	226282	394	226700	399
225508	82	225806	206	225966	77	226286	400	226701	400
225510	59	225817	206	225969	38	226289	400	226722	390
225514	41	225821	206	225969	77	226305	405	226725	60
225518	7	225824	206	225970	38	226306	396	226730	399
225520	43	225833	72	225970	77	226309	401	226744	386
225521	7	225856	176	225971	149	226311	392	226745	386
225528	59	225866	77	225977	149	226312	392	226752	391
225529	59	225867	77	225986	26	226330	394	226753	391
225531	7	225868	77	225993	59	226331	394	226760	385
225533	60	225869	77	225994	59	226334	395	226761	385
225540	201	225870	77	225997	26	226335	395	226762	385
225541	201	225871	77	225998	59	226338	394	226775	386
225599	173	225873	78	225999	59	226341	395	226777	386
225600	70	225874	78	226002	392	226361	70	226784	254
225601	36	225875	78	226003	392	226361	390	226786	399
225601	70	225876	77	226004	392	226370	384	226787	391
225606	139	225877	77	226005	392	226372	384	226789	394
225610	110	225878	77	226006	392	226379	401	226790	251
225614	139	225879	78	226025	394	226382	384	226790	383
225619	36	225880	78	226028	52	226383	387	226917	409
225619	59	225881	78	226029	52	226384	387	226918	409
225620	82	225882	78	226030	402	226385	387	226960	396
225629	256	225883	78	226037	390	226387	384	226961	396
225629	407	225886	78	226047	206	226457	411	226981	408
225632	78	225887	78	226048	398	226458	411	226982	409
225634	60	225888	78	226050	406	226461	411	226983	409
225635	60	225889	78	226054	405	226462	411	227274	253
225642	63	225890	78	226056	406	226467	411	227291	407
225647	36	225893	206	226057	405	226468	411	227292	397
225647	45	225896	72	226060	383	226473	411	227293	397
225648	183	225905	165	226061	383	226474	411	227368	398
225649	165	225908	98	226065	400	226481	411	227369	398
225655	76	225909	98	226066	400	226510	396	227370	408
225655	77	225918	46	226069	392	226512	396	227385	404
225659	77	225919	46	226070	392	226513	396	227453	404
225661	77	225925	95	226080	70	226515	252	227457	256
225662	77	225926	95	226081	70	226516	401	227457	407
225663	49	225927	7	226083	70	226517	401	227461	408
225673	165	225928	7	226092	392	226524	401	227462	408
225678	63	225929	7	226161	410	226526	401	227463	408
225681	157	225945	19	226168	410	226527	253	227484	393
225689	38	225945	20	226169	408	226527	391	227563	253
225689	76	225946	14	226173	411	226532	254	227571	255
225690	139	225949	60	226174	411	226567	396	227579	255
225693	186	225950	6	226175	411	226574	401	227579	398
225694	6	225951	162	226176	411	226575	401	227592	252
225700	165	225951	166	226188	411	226580	396	227593	252
225702	165	225952	162	226223	405	226586	400	227594	252
225706	77	225952	166	226231	405	226587	400	227595	252
225724	60	225953	162	226233	405	226649	411	227601	252
225727	206	225953	166	226235	405	226650	411	227601	386
225740	77	225954	162	226236	405	226651	411	227603	252
225741	77	225954	166	226240	392	226652	411	227603	386

## NUMERICAL INDEX

Part No.	Page No.	Part No.	Page No.	Part No.	Page No.	Part No.	Page No.	Part No.	Page No.
227606	398	227722	256	227810	384	228038	387	228320	409
227607	398	227723	256	227819	408	228046	398	228323	400
227608	398	227723	408	227820	408	228051	394	228329	392
227609	398	227726	252	227822	408	228061	391	228330	403
227621	398	227727	252	227839	252	228069	397	228346	403
227624	252	227728	252	227881	256	228094	397	228348	403
227624	385	227729	252	227882	256	228095	397	228352	396
227630	252	227732	392	227883	254	228098	397	228375	402
227630	386	227733	392	227884	254	228099	397	228376	384
227631	253	227736	252	227885	254	228121	400	228377	384
227631	391	227737	252	227886	252	228125	256	228378	384
227636	386	227738	252	227886	385	228125	400	228379	384
227637	386	227739	252	227887	404	228127	395	228381	384
227642	386	227742	398	227888	251	228128	395	228382	384
227643	386	227743	398	227888	385	228129	395	228383	384
227644	397	227745	402	227889	252	228130	395	228384	384
227645	397	227746	402	227889	385	228135	396	228385	384
227646	398	227747	402	227890	251	228137	396	228386	385
227648	397	227753	398	227890	385	228139	396	228388	385
227649	397	227756	397	227891	252	228144	412	228390	385
227652	397	227757	251	227891	385	228145	392	228391	385
227653	397	227757	384	227893	252	228149	396	228392	385
227654	403	227758	398	227893	385	228150	253	228393	385
227655	403	227759	398	227894	252	228150	389	228394	385
227656	403	227760	256	227894	385	228154	391	228395	385
227657	403	227760	407	227896	385	228155	401	228396	385
227660	397	227761	256	227897	252	228156	401	228406	408
227664	408	227761	407	227897	386	228157	401	228406	409
227665	408	227764	256	227898	252	228158	401	228407	410
227666	407	227765	398	227898	385	228170	391	228463	410
227667	408	227766	256	227899	390	228171	391	228468	411
227672	408	227767	256	227900	390	228177	397	228471	411
227673	406	227767	406	227901	254	228184	392	228474	411
227674	408	227768	397	227902	254	228185	392	228501	72
227675	408	227769	397	227903	254	228189	399	228503	70
227678	397	227770	256	227904	254	228193	397	228503	36
227679	397	227771	256	227905	254	228193	410	228504	71
227682	397	227774	255	227910	256	228195	393	228505	36
227683	397	227776	255	227911	256	228196	393	228505	69
227687	397	227777	255	227915	386	228196	410	228509	70
227688	398	227778	406	227916	386	228197	393	228510	70
227689	398	227779	407	227917	393	228200	385	228511	71
227692	392	227780	407	227918	393	228204	386	228514	24
227693	392	227781	407	227919	254	228205	386	228519	131
227696	391	227782	256	227920	256	228232	408	228526	26
227697	391	227782	407	227926	252	228234	408	228527	24
227698	402	227784	397	227926	386	228237	408	228530	19
227699	402	227786	404	227938	253	228246	251	228531	19
227700	402	227787	404	227939	253	228246	384	228532	78
227701	402	227794	407	227940	253	228250	251	228533	78
227702	401	227795	404	227941	253	228250	383	228536	20
227703	401	227796	404	227943	254	228251	251	228539	44
227704	402	227797	404	227946	254	228251	384	228542	77
227705	402	227798	404	227947	254	228260	251	228543	77
227710	252	227799	404	227948	254	228260	384	228546	77
227711	252	227807	395	227984	404	228272	402	228547	77
227713	397	227808	251	227991	404	228272	405	228548	77
227716	392	227808	384	227996	253	228312	401	228558	6
227717	392	227810	251	227998	253	228314	401	228559	6

## NUMERICAL INDEX

Part No.	Page No.	Part No.	Page No.	Part No.	Page No.	Part No.	Page No.	Part No.	Page No.
228563	53	228805	96	229250	396	230037	398	230190	21
228564	54	228806	96	229255	70	230038	398	230191	19
228566	54	228814	59	229261	394	230039	398	230191	21
228568	54	228823	149	229262	392	230040	398	230207	6
228581	60	228826	46	229268	254	230041	397	230211	149
228593	60	228827	43	229273	405	230042	398	230222	127
228602	60	228827	149	229274	405	230043	398	230223	149
228603	173	228828	41	229280	405	230044	397	230224	128
228603	174	228841	206	229283	405	230045	397	230229	127
228603	175	228842	206	229284	393	230046	398	230230	128
228609	55	228847	206	229289	398	230047	398	230231	128
228610	55	228849	6	229324	402	230048	397	230232	128
228615	77	228850	14	229324	405	230049	397	230233	128
228618	24	228851	204	229326	385	230050	397	230234	127
228634	46	228888	43	229328	256	230051	398	230235	127
228635	46	228896	128	229328	400	230052	398	230237	127
228636	55	228899	128	229329	399	230053	397	230238	128
228637	55	228901	163	229334	388	230054	397	230239	128
228638	55	228902	7	229340	251	230055	397	230241	127
228639	55	228907	148	229340	384	230056	397	230245	149
228646	69	228908	148	229344	252	230057	397	230246	129
228650	50	228913	148	229344	386	230058	397	230247	77
228653	98	228914	148	229345	252	230059	397	230248	77
228654	98	228919	203	229345	386	230060	69	230249	77
228655	18	228921	203	229346	406	230060	72	230249	128
228675	109	228923	203	229349	388	230062	27	230250	77
228678	77	228927	203	229392	395	230064	28	230253	15
228679	77	228928	19	229413	390	230066	127	230254	15
228680	77	228929	38	229428	69	230067	78	230292	127
228681	77	228930	38	229446	386	230068	26	230295	49
228688	14	228931	38	229447	393	230073	38	230296	49
228693	14	228932	38	229448	393	230073	44	230300	386
228702	14	228933	38	229449	393	230077	38	230304	128
228711	157	228934	38	229450	393	230077	40	230311	38
228712	157	228935	38	229456	387	230078	38	230313	163
228713	157	228936	38	229499	393	230078	40	230317	173
228714	157	228937	38	229577	411	230079	38	230328	192
228734	157	228938	59	229578	411	230079	40	230342	182
228735	157	228940	256	229579	411	230084	128	230345	36
228740	24	228940	407	229585	410	230086	71	230345	40
228741	24	228949	19	229595	397	230097	38	230348	166
228743	24	228949	20	229705	410	230098	38	230348	174
228755	59	228949	21	229744	410	230104	36	230348	177
228761	156	228951	184	229746	410	230104	70	230369	115
228762	156	228952	184	229772	410	230117	148	230389	21
228767	156	228952	185	229819	400	230142	163	230390	21
228768	156	228953	45	229820	389	230143	163	230391	20
228781	125	228956	199	229822	389	230146	54	230391	21
228784	203	228957	199	229823	389	230147	54	230392	20
228786	176	228958	185	229849	389	230162	49	230392	21
228786	177	228960	20	230006	199	230163	49	230393	20
228787	71	228960	21	230007	199	230172	50	230393	21
228788	71	228961	20	230008	80	230174	50	230394	162
228790	13	228962	47	230031	397	230176	50	230394	166
228791	14	228965	44	230032	397	230177	149	230395	162
228801	96	228968	6	230033	397	230178	149	230395	166
228802	96	228972	26	230034	397	230182	7	230398	165
228803	96	229223	386	230035	398	230183	7	230399	165
228804	96	229224	386	230036	398	230190	19	230428	150

## NUMERICAL INDEX

Part No.	Page No.	Part No.	Page No.	Part No.	Page No.	Part No.	Page No.	Part No.	Page No.
230429	..... 150	230497	..... 166	231024	.... 162	231082	..... 96	304308	..... 77
230430	..... 38	230518	..... 255	231024	.... 166	231083	..... 96	307458	..... 78
230430	..... 115	230519	..... 255	231025	.... 162	231084	..... 96	307640	..... 389
230438	..... 59	230520	..... 255	231025	.... 166	231085	..... 96	308802	..... 390
230450	..... 147	230521	..... 255	231026	.... 162	231092	..... 6	310259	..... 390
230459	..... 165	230522	..... 255	231027	.... 162	231093	..... 6	310404	..... 389
230470	..... 21	230524	..... 255	231029	.... 165	300181	..... 164	310405	..... 389
230494	..... 162	230525	..... 255	231031	.... 19	302121	..... 43	310423	..... 390
230495	..... 162	230526	..... 255	231031	.... 20	302620	..... 19	310424	..... 390
230495	..... 166	230527	..... 255	231031	.... 21	302620	..... 21	310427	..... 390
230496	..... 162	230530	..... 255	231032	.... 17	303074	..... 11	310655	..... 389
230496	..... 166	231007	..... 176	231080	.... 96	303796	..... 36	310738	..... 390
230497	..... 162	231009	..... 176	231081	.... 96	303796	..... 42	311539	..... 125



Piece No.	Name	No. Required				
		905 906	1005 1006	1107 1108	1207 1208	1407 1408
<b>ACCELERATOR</b>						
194666	Accelerator pedal .....	1	1	-	-	-
215138	Accelerator pedal .....	-	-	1	1	1
114495	Accelerator pedal bracket .....	1	1	1	1	1
5506	Lockwasher 3/8" .....	1	1	1	1	1
7006	Nut 3/8" .....	1	-	-	-	-
6277	Nut 3/8-24 blind .....	-	1	1	1	1
3877	Washer 3/8" plain .....	1	1	1	1	1
5806	Lockwasher 7/16" .....	2	2	2	2	2
4023	Taper pin No. 0 x 3/4" .....	1	1	1	1	1
194751	Accelerator pedal insulating sleeve .....	1	1	1	1	1
194752	Insulating washer .....	2	2	2	2	2
190941	Accelerator pedal hole cover .....	1	1	1	-	-
5390	Screw 1/4-28 x 1-3/8" hex. hd. ....	1	1	1	-	-
5502	Lockwasher 1/4" .....	1	1	1	-	-
210811	Accelerator pedal retracting spring .....	-	1	1	1	1
201905	Accelerator pedal shaft .....	1	-	-	-	-
209056	Accelerator pedal shaft assembly (Not used with clutch control) .....	-	1	1	-	-
210943	Accelerator pedal shaft assembly (Used only with clutch control) .....	-	1	-	-	-
223573	Accelerator pedal shaft assembly .....	-	-	-	1	1
158159	Accelerator pedal shaft bracket-right .....	1	1	1	1	1
190952	Accelerator pedal shaft bracket-left .....	1	1	1	-	-
197547	Accelerator pedal shaft bracket-left .....	-	-	-	1	1
5470	Screw 1/4-28 x 3/4" hex. hd. ....	-	-	-	3	3
5377	Screw 1/4-28 x 1-1/8" hex. hd. ....	2	2	2	-	-
5502	Lockwasher 1/4" .....	2	2	2	3	3
201654	Accelerator pedal shaft bracket retainer .....	1	-	-	-	-
202701	Accelerator pedal shaft lever .....	1	-	-	-	-
210912	Accelerator pedal shaft lever (Used only with clutch control) .....	-	1	-	-	-
209053	Accelerator pedal shaft lever (Not used with clutch control) .....	-	1	1	-	-
223574	Accelerator pedal shaft lever .....	-	-	-	1	1
4023	Taper pin No. 0 x 3/4" .....	1	-	-	-	-
202453	Accelerator pedal shaft lever free .....	1	-	-	-	-
207750	Spring washer 7/16" (Supersedes 186436) .....	1	-	-	-	-
3912	Washer 7/16" plain .....	1	1	-	-	-
202287	Accelerator pedal shaft lever conn. link (Prior to Frame No. 900450) .....	1	-	-	-	-
205944	Accelerator pedal shaft lever conn. link (After Frame No. 900449) .....	2	-	-	-	-
6123	Yoke end pin 1/4" .....	2	-	-	-	-
4280	Cotter pin 1/16 x 1/2" .....	2	-	-	-	-
201900	Accelerator pedal shaft lever to carburetor throttle valve shaft conn. rod .....	1	-	-	-	-
209075	Accelerator pedal shaft lever to carburetor throttle valve shaft conn. rod (Not used with clutch control) ..	-	1	1	-	-
210814	Accelerator pedal shaft lever to carburetor throttle valve shaft conn. rod (Used with clutch control only) ..	-	1	-	-	-
221388	Accelerator pedal shaft lever to carburetor throttle valve conn. rod .....	-	-	-	1	1
143143	Ball joint No. 10-32 R.H. thd. (Not used with clutch control) .....	1	2	2	2	2
202751	Ball joint (L.H. thd.) .....	1	1	-	-	-
210097	Ball joint (R.H. thd.) (Used with clutch control) ..	-	1	-	-	-
7003	Nut No. 10-32 (R.H. thd.) .....	3	4	4	4	4

Piece No.	Name	No. Required				
		905 906	1003 1006	1107 1108	1207 1208	1407 1408
6134	Nut No. 10-32 (L.H. thd.) .....	1	1	-	-	-
5500	Lockwasher No. 10 .....	2	2	2	2	2
202868	Accelerator pedal shaft lever to carburetor throttle valve conn. rod retracting spring .....	-	1	-	-	-
205106	Accelerator pedal shaft lever to carburetor throttle valve conn. rod retracting spring bracket .....	-	1	-	-	-
209055	Accelerator pedal shaft spring .....	-	1	1	1	1
3912	Washer 7/16" .....	-	1	1	-	-

## BATTERY BOX

190783	Battery box assembly .....	1	-	-	-	-
186986	Battery box battery clamp assembly .....	2	-	-	-	-
7300	Screw 1/4-28 x 1" hex. hd. ....	2	-	-	-	-
7004	Nut 1/4-28 .....	2	-	-	-	-
5502	Lockwasher 1/4" .....	2	-	-	-	-
190196	Battery box battery clamp anchor bolt .....	2	-	-	-	-
191237	Battery box battery clamp anchor bolt spacer .....	2	-	-	-	-
7004	Nut 1/4-28 .....	6	-	-	-	-
5502	Lockwasher 1/4" .....	4	-	-	-	-
62065	Plain washer 17/64 x 3/4" .....	4	-	-	-	-
190735	Battery box cover assembly .....	1	-	-	-	-
190148	Battery box cover cushion .....	1	-	-	-	-
7003	Battery box cover cushion retainer and finishing plate screw nut No. 10-32 .....	14	-	-	-	-
5500	Lockwasher No. 10 .....	14	-	-	-	-
191894	Battery box cover finishing plate .....	1	-	-	-	-
194883	Battery box cover lock bolt .....	1	-	-	-	-
190704	Battery box cover lock bolt bracket .....	1	-	-	-	-
190719	Battery box cover lock bolt bracket screw .....	1	-	-	-	-
7004	Nut 1/4-28 .....	1	-	-	-	-
5502	Lockwasher 1/4" .....	1	-	-	-	-
194884	Battery box cover lock bolt spacer .....	1	-	-	-	-
194885	Screw .....	1	-	-	-	-
7003	Nut No. 10-32 .....	1	-	-	-	-
5500	Lockwasher No. 10 .....	1	-	-	-	-
190706	Battery box cover lock bolt spring .....	1	-	-	-	-
186982	Battery box cover lock cylinder assembly .....	1	-	-	-	-
186981	Battery box cover lock cylinder plate .....	1	-	-	-	-
190305	Battery box cover lock cylinder plate to cylinder screw No. 4-40 x 3/16" F.H. ....	1	-	-	-	-
7827	Battery box to fender bolt 1/4-28 x 3/4" hex. hd. ....	6	-	-	-	-
169049	Battery box to fender bolt 1/4-28 x 5/8" carriage .....	3	-	-	-	-
5502	Lockwasher 1/4" .....	6	-	-	-	-
7004	Nut 1/4-28 .....	9	-	-	-	-
62065	Washer 17/64 x 3/4" plain .....	15	-	-	-	-
5241	Battery box to fender screw 1/4-28 x 3/4" O.H. (Use with side wheel carrier) .....	1	-	-	-	-
195901	Battery box to fender screw (Use with side wheel carrier) .....	1	-	-	-	-
195902	Nut (Use with side wheel carrier) .....	1	-	-	-	-
5753	Battery box to frame bolt 5/16-24 x 1-7/8" hex. hd. ....	4	-	-	-	-
3909	Washer 5/16" .....	x	-	-	-	-
5504	Lockwasher 5/16" .....	4	-	-	-	-
7005	Nut 5/16-24 .....	4	-	-	-	-
190805	Battery box liner .....	1	-	-	-	-

Piece No.	Name	No. Required				
		905 906	1005 1006	1107 1108	1207 1208	1407 1408
<b>BONNET</b>						
(Specify color and striping on all orders for Bonnet Assemblies)						
209390	Bonnet assembly (With chromium doors) (Used on bodies 630-1-9-641-3-7) .....	-	1	-	-	-
203124	Bonnet assembly (With chromium doors) .....	1	-	-	-	-
209391	Bonnet assembly (With chromium doors) (Used on bodies 633-4-5-6-7-8-5633-5633-A) .....	-	1	-	-	-
202652	Bonnet assembly .....	1	-	-	-	-
207299	Bonnet assembly (Used on bodies 630-1-9-641-3-7) .....	-	1	-	-	-
207300	Bonnet assembly (Used on bodies 633-4-5-6-7-8-5633-5633-A) .....	-	1	-	-	-
215295	Bonnet assembly (Used on bodies 730-1-8-9-741-3-7) .....	-	-	1	-	-
215296	Bonnet assembly (Used on bodies 732-3-4-5-6-7-D858-D859) .....	-	-	1	-	-
215318	Bonnet assembly (With chromium doors) (Used on 730-1-8-9-741-43-47) .....	-	-	1	-	-
215319	Bonnet assembly (With chromium doors) (Used on 732-3-4-5-7) .....	-	-	1	-	-
215798	Bonnet assembly (With chromium doors) (Used on 736) .....	-	-	1	-	-
194659	Bonnet clamp bracket front-right .....	1	1	1	-	-
194658	Bonnet clamp bracket front-left .....	1	1	1	-	-
6230	Screw 1/4-28 x 11/16" flat hd. ....	4	-	4	-	-
6130	Screw 1/4-28 x 3/4" flat hd. mach. ....	-	4	-	-	-
5502	Lockwasher 1/4" .....	4	4	2	-	-
3868	Washer 1/4" .....	4	-	-	-	-
7004	Nut 1/4-28 .....	4	4	2	-	-
191926	Bonnet clamp bracket rear-right .....	1	-	-	-	-
191927	Bonnet clamp bracket rear-left .....	1	-	-	-	-
207183	Bonnet clamp bracket rear-right (Used on bodies 630-1-9-641-3-7-730-1-8-9-741-3-7) .....	-	1	1	-	-
205937	Bonnet clamp bracket rear-right (Used on bodies 633-4-5-6-7-8-5633-5633-A-732-3-4-5-6-7-D858-D859) .....	-	1	1	-	-
205938	Bonnet clamp bracket rear-left (Used on bodies 633-4-5-6-7-8-5633-5633-A-732-3-4-5-6-7-D858-D859) .....	-	1	1	-	-
207182	Bonnet clamp bracket rear-left (Used on bodies 630-1-9-641-3-7-730-1-8-9-741-3-7) .....	-	1	1	-	-
5451	Screw 5/16-24 x 1-1/2" hex. hd. ....	4	4	4	-	-
5504	Lockwasher 5/16" .....	4	4	4	-	-
7005	Nut 5/16-24 .....	4	4	4	-	-
190833	Bonnet clamp handle-left .....	1	1	1	-	-
190834	Bonnet clamp handle-right .....	1	1	1	-	-
194602	Bonnet clamp handle lockwasher .....	2	2	2	-	-
194601	Bonnet clamp handle nut .....	2	2	2	-	-
190942	Bonnet clamp operating lever-left .....	1	1	1	-	-
190943	Bonnet clamp operating lever-right .....	1	1	1	-	-
190954	Bonnet clamp operating lever bearing plate left assembly .....	1	1	-	-	-
190955	Bonnet clamp operating lever bearing plate right assembly .....	1	1	1	-	-
191104	Bonnet clamp operating rod-right .....	1	1	1	-	-
191105	Bonnet clamp operating rod-left .....	1	1	1	-	-
4230	Cotter pin 1/16 x 1/2" .....	2	2	2	-	-
191144	Bonnet clamp rod-right .....	1	-	-	-	-
207305	Bonnet clamp rod-right .....	-	1	1	-	-
207304	Bonnet clamp rod-left .....	-	1	1	-	-
191903	Bonnet clamp rod-left .....	1	-	-	-	-
210297	Bonnet clamp rod bearing .....	8	8	8	-	-
182215	Bonnet clamp rod bearing screw .....	16	16	16	-	-
5500	Lockwasher No. 10 .....	16	16	16	-	-

Piece No.	Name	No. Required				
		905 906	1005 1006	1107 1108	1207 1208	1407 1408
7003	Nut No. 10-32 .....	16	16	16	-	-
191939	Bonnet corner guide .....	2	-	-	-	-
209620	Bonnet corner guide .....	-	2	2	-	-
209629	Bonnet corner guide guard .....	-	2	2	-	-
194257	Bonnet corner guide guard .....	2	-	-	-	-
194607	Bonnet corner guide guard rivet .....	4	4	4	-	-
202647	Bonnet frame ledge left assembly .....	1	-	-	-	-
207318	Bonnet frame ledge left assembly .....	-	1	1	-	-
207319	Bonnet frame ledge right assembly .....	-	1	1	-	-
202648	Bonnet frame ledge right assembly .....	1	-	-	-	-
7827	Bonnet frame ledge to battery screw 1/4-28 x 3/4" .....	1	-	-	-	-
5502	Lockwasher 1/4" .....	2	-	-	-	-
5241	Bonnet frame ledge to frame bolt 1/4-28 x 3/4" oval hd..	-	2	2	-	-
5344	Bonnet frame ledge to frame bolt 1/4-28 x 1-3/4" fill. hd. ....	-	1	1	-	-
7704	Bonnet frame ledge to frame bolt 1/4-28 x 3/4" fill. hd.	-	1	1	-	-
7612	Bonnet frame ledge to frame bolt-rear 1/4-28 x 3/4" common carriage .....	-	2	2	-	-
7004	Nut 1/4-28 .....	-	6	6	-	-
194029	Bonnet frame ledge to frame stud-front .....	2	2	2	-	-
194824	Bonnet frame ledge to frame stud-rear .....	2	-	-	-	-
5502	Lockwasher 1/4" .....	2	2	2	-	-
194030	Nut .....	2	2	2	-	-
191619	Bonnet frame ledge liner retainer .....	2	-	-	-	-
191151	Bonnet frame ledge screw boss liner .....	2	-	-	-	-
7801	Bonnet frame ledge bracket screw 1/4-28 x 1/2" hex. hd..	1	-	-	-	-
7827	Bolt 1/4-28 x 3/4" hex. hd. ....	2	-	-	-	-
7004	Nut 1/4-28 .....	5	-	-	-	-
5502	Lockwasher 1/4" .....	7	-	-	-	-
62065	Washer 17/64 x 3/4" plain .....	4	-	-	-	-
5701	Bonnet frame ledge screw (Screw 1/4-28 x 9/16" flat hd.)	4	4	4	-	-
209459	Bonnet frame ledge hold down plate-front .....	-	2	2	-	-
209460	Bonnet frame ledge hold down plate-rear .....	-	2	2	-	-
191151	Bonnet frame ledge hold down plate-front liner .....	-	4	4	-	-
210817	Bonnet frame ledge to motor support bolt anti-squeak ...	-	2	2	-	-
191264	Bonnet frame ledge spacer .....	2	-	-	-	-
194029	Bonnet frame ledge to tool box stud (Supersedes 194761).	1	-	-	-	-
62065	Washer 17/64 x 3/4" .....	2	-	-	-	-
7004	Nut 1/4" std. ....	1	-	-	-	-
190965	Bonnet hinge side pin .....	2	-	-	-	-
207175	Bonnet hinge side pin .....	-	2	2	-	-
194732	Bonnet hinge side pin spring washer .....	-	-	x	-	-
201236	Bonnet hinge top .....	1	-	-	-	-
207906	Bonnet hinge top .....	-	1	1	-	-
5996	Rivet No. 632 x 9/64 x 1/4" O.H. tubing .....	44	44	44	-	-
190739	Bonnet hinge top bracket-rear .....	1	1	-	-	-
219567	Bonnet hinge top bracket-rear assembly .....	-	-	1	-	-
5565	Screw 1/4-28 x 1/2" O.H. ....	2	2	2	-	-
5396	Lockwasher 1/4" .....	2	2	2	-	-
219566	Bonnet hinge top bracket-rear-liner .....	-	-	1	-	-
201250	Bonnet hinge top bracket-front .....	1	1	-	-	-
215400	Bonnet hinge top bracket-front .....	-	-	1	-	-
6230	Screw 1/4-28 x 11/16" F.H. ....	2	2	2	-	-
7004	Nut 1/4" plain .....	2	2	2	-	-
5502	Lockwasher 1/4" .....	2	2	2	-	-
219979	Bonnet hinge top-rear-liner .....	-	-	1	-	-
194792	Bonnet side bumper-left .....	1	-	-	-	-
194793	Bonnet side bumper-right .....	1	-	-	-	-
215086	Bonnet side bumper-left .....	-	-	1	-	-
215087	Bonnet side bumper-right .....	-	-	1	-	-

Piece No.	Name	No. Required				
		905 906	1005 1006	1107 1108	1207 1208	1407 1408
194736	Bonnet side bumper rivet .....	12	-	-	-	-
209628	Bonnet side bumper .....	-	2	-	-	-
182215	Bonnet side bumper screw .....	-	4	4	-	-
7003	Nut No. 10-32 .....	-	4	4	-	-
209623	Bonnet side bumper plate .....	-	4	-	-	-
209623	Bonnet side bumper plate-long .....	-	-	2	-	-
216220	Bonnet side bumper plate-short .....	-	-	2	-	-
215085	Bonnet side check strap .....	-	-	2	-	-
6394	Screw 1/4-28 x 1 3/16" Rnd. Hd. ....	-	-	2	-	-
62065	Washer 17/64 .....	-	-	2	-	-
5502	Lockwasher 1/4 .....	-	-	2	-	-
205873	Bonnet side corner bumper-right .....	1	-	-	-	-
205872	Bonnet side corner bumper-left .....	1	-	-	-	-
6232	Rivet 3/32 x 1/4 O.H. tubular .....	4	-	-	-	-
207181	Bonnet side corner bumper-left .....	-	1	1	-	-
209630	Bonnet side corner bumper-right .....	-	1	1	-	-
6285	Rivet 3/32 x 3/8" oval hd. split .....	-	4	4	-	-
207196	Bonnet side bumper (Rubber) .....	2	-	-	-	-
205851	Bonnet side and door assembly-right .....	1	-	-	-	-
205852	Bonnet side and door assembly-left .....	1	-	-	-	-
205853	Bonnet side and door assembly-right (Chrome plated doors) .....	1	-	-	-	-
205854	Bonnet side and door assembly-left (Chrome plated doors)	1	-	-	-	-
215899	Bonnet side and door assembly-left (Used on 630-1-9- 641-3-7) .....	-	1	-	-	-
215900	Bonnet side and door assembly-right (Used on 630-1-9- 641-3-7) .....	-	1	-	-	-
215903	Bonnet side and door assembly-left (Used on 633-4-5-6- 7-8-5633-5633-A-D758-D759) .....	-	1	-	-	-
215904	Bonnet side and door assembly-right (Used on 633-4-5-6- 7-8-5633-5633-A) .....	-	1	-	-	-
219562	Bonnet side left and door assembly (Used on 730-1-8-9- 741-3-7) .....	-	-	1	-	-
219565	Bonnet side left and door assembly (Used on 732-3-4-5-6- 7-D858-D859) .....	-	-	1	-	-
219559	Bonnet side right and door assembly (Used on 730-1-8-9- 741-3-7) .....	-	-	1	-	-
219561	Bonnet side right and door assembly (Used on 732-3-4-5- 6-7-D858-D859) .....	-	-	1	-	-
194568	Bonnet side door left assembly .....	4	4	-	-	-
215314	Bonnet side door left assembly .....	-	-	4	-	-
191477	Bonnet side door left assembly (Chromium) .....	4	4	-	-	-
215320	Bonnet side door left assembly (Chromium) .....	-	-	4	-	-
194569	Bonnet side door right assembly .....	4	4	-	-	-
215315	Bonnet side door right assembly .....	-	-	4	-	-
194570	Bonnet side door right assembly (Chromium) .....	4	4	-	-	-
215321	Bonnet side door right assembly (Chromium) .....	-	-	4	-	-
215163	Bonnet side door handle .....	-	-	8	-	-
6379	Screw No. 6-32 x 5/16" Rnd. hd. mach. ....	-	-	8	-	-
3905	Washer 1/8 plain .....	-	-	8	-	-
3516	Lockwasher No. 6 .....	-	-	8	-	-
191656	Bonnet side door knob .....	8	8	-	-	-
5694	Screw .....	8	8	-	-	-
5695	Lockwasher No. 8 .....	8	8	-	-	-
3866	Washer plain .....	8	8	-	-	-
191157	Bonnet side door hinge rivet .....	16	16	16	-	-
3905	Bonnet side door hinge rivet washer .....	16	16	16	-	-
191161	Bonnet side door hinge washer .....	8	8	8	-	-
191159	Bonnet side door spring .....	8	8	8	-	-
192324	Bonnet top moulding bumper .....	2	2	2	-	-



Piece No.	Name	No. Required				
		905 906	1005 1006	1107 1108	1207 1208	1407 1408
<b>BONNET</b>						
(Specify color and striping on all orders for Bonnet Assemblies)						
225468	Bonnet assembly (Specify color) .....	-	-	-	1	-
230207	Bonnet assembly (Specify color) .....	-	-	-	-	1
225013	Bonnet clamp bracket front assembly-right .....	-	-	-	1	1
225014	Bonnet clamp bracket front assembly-left .....	-	-	-	1	1
223329	Bonnet clamp bracket rear-right .....	-	-	-	1	1
228849	Bonnet clamp bracket rear-left .....	-	-	-	1	1
5430	Bonnet clamp bracket to radiator core screw 1/4-28 x 1/2" hex. hd. ....	-	-	-	4	4
5502	Lockwasher 1/4" .....	-	-	-	4	4
7824	Bonnet clamp bracket to radiator core bolt 1/4-28 x 5/8" hex. hd. ....	-	-	-	2	2
5502	Lockwasher 1/4" .....	-	-	-	2	2
7004	Nut 1/4-28 .....	-	-	-	2	2
7842	Bonnet clamp bracket front to radiator fan shroud screw 1/4-28 x 1-1/4" hex. hd. ....	-	-	-	2	2
62065	Washer 1/4 plain .....	-	-	-	2	2
5502	Lockwasher 1/4" .....	-	-	-	2	2
7004	Nut 1/4-28 .....	-	-	-	2	2
228968	Bonnet clamp bracket front to radiator fan shroud screw spacer .....	-	-	-	2	2
223481	Bonnet clamp handle-left .....	-	-	-	1	1
223480	Bonnet clamp handle-right .....	-	-	-	1	1
194601	Bonnet clamp handle nut .....	-	-	-	2	2
194602	Bonnet clamp handle lockwasher .....	-	-	-	2	-
6597	Bonnet clamp handle lockwasher--3/8 Shakeproof .....	-	-	-	-	2
223443	Bonnet clamp operating lever-right .....	-	-	-	1	1
223444	Bonnet clamp operating lever-left .....	-	-	-	1	1
223437	Bonnet clamp operating lever bearing plate assembly- right .....	-	-	-	1	1
223438	Bonnet clamp operating lever bearing plate assembly-left .....	-	-	-	1	1
223432	Bonnet clamp rod-right .....	-	-	-	1	1
223433	Bonnet clamp rod-left .....	-	-	-	1	1
210297	Bonnet clamp rod bearing .....	-	-	-	4	4
182215	Bonnet clamp rod bearing screw .....	-	-	-	8	8
5500	Lockwasher No. 10 .....	-	-	-	8	8
7003	Nut No. 10-32 .....	-	-	-	8	8
225694	Bonnet cowl guard .....	-	-	-	2	2
199787	Screw No. 8 x 1/2 Parker Kalon .....	-	-	-	10	10
223103	Bonnet hinge side pin .....	-	-	-	2	2
194732	Bonnet hinge side pin spring washer .....	-	-	-	x	x
225159	Bonnet louver panel side-right .....	-	-	-	2	2
225158	Bonnet louver panel side-left .....	-	-	-	2	2
6379	Bonnet louver panel screw No. 6-32 x 5/16 rnd. hd. mach. Lockwasher No. 6 .....	-	-	-	24	24
3516	Lockwasher No. 6 .....	-	-	-	24	24
228558	Bonnet side left and door assembly (Specify color) .....	-	-	-	1	-
231092	Bonnet side left and door assembly (Specify color) .....	-	-	-	-	1
228559	Bonnet side right and door assembly (Specify color) .....	-	-	-	1	-
231093	Bonnet side right and door assembly (Specify color) .....	-	-	-	-	1
225351	Bonnet side bumper center .....	-	-	-	2	2
211205	Screw No. 10 (.106) x 1/2 rnd. hd. (Parker Kalon) .. Washer 3/16" .....	-	-	-	4	4
3966	Washer 3/16" .....	-	-	-	4	4
225950	Bonnet side check strap .....	-	-	-	2	2
6394	Screw 1/4-28 x 13/16" rnd. hd. mach. ....	-	-	-	2	2
62065	Washer 1/4" .....	-	-	-	2	2
5502	Lockwasher 1/4" .....	-	-	-	2	2

Piece No.	Name	No. Required				
		905 906	1005 1006	1107 1108	1207 1208	1407 1408
223563	Bonnet side corner bumper left assembly .....	-	-	-	1	-
230182	Bonnet side corner bumper left assembly .....	-	-	-	-	1
223564	Bonnet side corner bumper right assembly .....	-	-	-	1	-
230183	Bonnet side corner bumper right assembly .....	-	-	-	-	1
225394	Bonnet side door right assembly (Specify color) .....	-	-	-	5	5
225393	Bonnet side door left assembly (Specify color) .....	-	-	-	5	5
191157	Bonnet side door hinge rivet .....	-	-	-	20	20
3905	Washer 1/8" special .....	-	-	-	20	20
191161	Bonnet side door hinge washer .....	-	-	-	10	10
228902	Bonnet side door spring (Supersedes 191159) .....	-	-	-	10	10
225140	Bonnet side panel moulding-long .....	-	-	-	4	4
225141	Bonnet side panel moulding-short .....	-	-	-	4	4
6471	Bonnet side panel moulding screw .....	-	-	-	36	36
5435	Washer .....	-	-	-	36	36
3516	Lockwasher No. 6 .....	-	-	-	36	36
221640	Bonnet top center panel hinge pin .....	-	-	-	2	2
225440	Bonnet top center panel moulding .....	-	-	-	1	1
225521	Bonnet top center panel moulding fastener .....	-	-	-	1	1
225505	Bonnet top center panel moulding screw .....	-	-	-	6	6
7003	Nut No. 10-32 .....	-	-	-	6	6
5500	Lockwasher No. 10 .....	-	-	-	6	6
223587	Bonnet top center panel moulding-rear screw .....	-	-	-	1	1
7003	Nut No. 10-32 .....	-	-	-	1	1
157435	Washer .....	-	-	-	1	1
3867	Washer 3/16" plain .....	-	-	-	1	1
5500	Lockwasher No. 10 .....	-	-	-	1	1
225927	Bonnet top center panel reinforcement-front .....	-	-	-	1	1
223473	Bonnet top center panel reinforcement-front liner .....	-	-	-	1	1
225531	Bonnet top center panel reinforcement-rear liner .....	-	-	-	1	1
225929	Bonnet top center panel reinforcement-front screw .....	-	-	-	2	2
7004	Nut 1/4-28 .....	-	-	-	2	2
5502	Lockwasher 1/4" .....	-	-	-	2	2
62065	Washer 1/4" .....	-	-	-	2	2
225928	Bonnet top center panel reinforcement-rear .....	-	-	-	1	1
225929	Bonnet top center panel reinforcement-rear screw .....	-	-	-	3	3
7004	Nut 1/4-28 .....	-	-	-	3	3
5502	Bonnet top center panel reinforcement-rear stud lock- washer 1/4" .....	-	-	-	3	3
62065	Washer 1/4" .....	-	-	-	3	3
225518	Bonnet top moulding bumper .....	-	-	-	2	2

## BRAKE AND CONTROL

190760	Brake assembly-front right (Complete) .....	1	-	-	-	-
190759	Brake assembly-front left (Complete) .....	1	-	-	-	-
191063	Brake assembly-rear right (Complete) (Used with standard rear axle) .....	1	-	-	-	-
191064	Brake assembly-rear left (Complete) (Used with standard rear axle) .....	1	-	-	-	-
203722	Brake assembly-rear right (Used with angle set rear axle) .....	1	-	-	-	-
203723	Brake assembly-rear left (Used with angle set rear axle)	1	-	-	-	-
138917	Brake assembly-front retaining bolt .....	16	-	-	-	-
7809	Brake assembly-front retaining screw 5/16-24 x 7/8" hex. hd. ....	8	-	-	-	-
7005	Nut 5/16-24 .....	16	-	-	-	-
5504	Lockwasher 5/16" .....	24	-	-	-	-
137960	Brake adjusting nut .....	4	-	-	-	-
7405	Locknut (Nut 5/16-24) .....	4	-	-	-	-

Piece No.	Name	No. Required				
		905 906	1005 1006	1107 1108	1207 1208	1407 1408
5504	Lockwasher 5/16" .....	4	-	-	-	-
138694	Brake adjusting nut spring .....	4	-	-	-	-
7005	Brake adjusting spring stop nut 5/16-24 .....	4	-	-	-	-
169198	Brake-front-camshaft right .....	1	-	-	-	-
169199	Brake-front-camshaft left .....	1	-	-	-	-
169323	Brake-front-camshaft bracket left .....	1	-	-	-	-
169322	Brake-front-camshaft bracket right .....	1	-	-	-	-
163461	Bolt .....	4	-	-	-	-
163435	Nut .....	4	-	-	-	-
4291	Cotter pin 3/32 x 3/4" .....	4	-	-	-	-
163455	Brake-front-camshaft bracket-bolt nut tension spring ...	4	-	-	-	-
169195	Brake-front-camshaft retaining key .....	2	-	-	-	-
169194	Brake-front-camshaft retaining key dust washer .....	2	-	-	-	-
164003	Brake-rear-camshaft .....	2	-	-	-	-
163425	Brake-rear-camshaft bearing-felt washer .....	2	-	-	-	-
163429	Brake-rear-camshaft bearing washer outer .....	2	-	-	-	-
5421	Brake-rear-camshaft bearing lubricator pipe plug 1/8" hex. hd. ....	2	-	-	-	-
163427	Brake-rear-camshaft bracket .....	2	-	-	-	-
163461	Bolt .....	4	-	-	-	-
163435	Nut .....	4	-	-	-	-
4291	Cotter pin 3/32 x 3/4" .....	4	-	-	-	-
163455	Brake-rear-camshaft bracket bolt nut tension spring ....	4	-	-	-	-
191007	Brake-rear-camshaft bracket support (Used with standard rear axle) .....	2	-	-	-	-
203729	Brake-rear-camshaft bracket support-right (Used with angle set rear axle) .....	1	-	-	-	-
203731	Brake-rear-camshaft bracket support-left (Used with angle set rear axle) .....	1	-	-	-	-
139509	Brake-rear-camshaft bracket support spacer .....	4	-	-	-	-
163424	Brake-rear-camshaft bushing .....	4	-	-	-	-
194778	Brake-rear-camshaft lever-right .....	1	-	-	-	-
194777	Brake-rear-camshaft lever-left .....	1	-	-	-	-
7512	Brake-rear-camshaft lever clamp bolt 5/16-24 x 1-3/4" hex. hd. ....	2	-	-	-	-
7005	Nut 5/16-24 .....	2	-	-	-	-
5504	Lockwasher 5/16" .....	2	-	-	-	-
163469	Brake-rear-camshaft retaining washer .....	2	-	-	-	-
190855	Brake-front connecting cable assembly .....	2	-	-	-	-
7515	Yoke end (adj.) 5/16" .....	2	-	-	-	-
7525	Yoke end pin 5/16" .....	2	-	-	-	-
7005	Nut 5/16-24 .....	2	-	-	-	-
4290	Cotter pin 3/32 x 5/8" .....	2	-	-	-	-
190291	5/16" spring washer .....	2	-	-	-	-
126828	Brake-front connecting cable frame ferrule inner .....	2	-	-	-	-
126587	Brake-front connecting cable frame ferrule outer .....	2	-	-	-	-
7827	Screw 1/4-28 x 3/4" hex. hd. ....	8	-	-	-	-
7004	Nut 1/4-28 .....	8	-	-	-	-
5502	Lockwasher 1/4" .....	8	-	-	-	-
191029	Brake-rear connecting rod long assembly (Used on 905 only) .....	2	-	-	-	-
191030	Brake-rear connecting rod long assembly (Used on 906 only) .....	2	-	-	-	-
7525	Yoke end pin 5/16" .....	3	-	-	-	-
114335	Yoke end pin .....	1	-	-	-	-
4290	Cotter pin 3/32 x 5/8" .....	4	-	-	-	-
190291	5/16" spring washer .....	4	-	-	-	-
191022	Brake-rear connecting rod short assembly .....	2	-	-	-	-
7525	Yoke end pin 5/16" .....	2	-	-	-	-

Piece No	Name	905 906	No. Required				
			1005 1006	1107 1108	1207 1208	1407 1408	
4290	Cotter pin 3/32 x 5/8" .....	2	-	-	-	-	
190291	5/16" spring washer .....	2	-	-	-	-	
184467	Brake-rear connecting rod lever and bushing assembly ...	2	-	-	-	-	
174096	Bushing .....	2	-	-	-	-	
174098	Brake-rear connecting rod lever shaft .....	2	-	-	-	-	
174093	Screw .....	2	-	-	-	-	
173398	Washer 5/8" plain .....	2	-	-	-	-	
7010	Nut 5/8-18 .....	2	-	-	-	-	
5514	Lockwasher 5/8" .....	2	-	-	-	-	
191432	Brake lever assembly (Supersedes 203340) .....	1	-	-	-	-	
191043	Brake lever bushing .....	1	-	-	-	-	
191056	Brake lever connecting rod assembly .....	1	-	-	-	-	
7005	Nut 5/16-24 .....	1	-	-	-	-	
190291	5/16" spring washer .....	1	-	-	-	-	
7525	Yoke end pin 5/16" .....	2	-	-	-	-	
4291	Cotter pin 3/32 x 3/4" .....	2	-	-	-	-	
191773	Brake lever connecting rod lever (Supersedes 203114) ...	1	-	-	-	-	
7810	Clamp screw 5/16-24 x 1-1/4" hex. hd. ....	1	-	-	-	-	
5504	Lockwasher 5/16" .....	1	-	-	-	-	
190291	5/16" spring washer .....	1	-	-	-	-	
5550	Key rectangular 1/4 x 5/16 x 1-1/4" .....	1	-	-	-	-	
191050	Brake lever latch rod assembly .....	1	-	-	-	-	
101808	Brake lever latch rod knob .....	1	-	-	-	-	
116504	Brake lever latch rod knob stop rivet .....	1	-	-	-	-	
101810	Brake lever latch spring .....	1	-	-	-	-	
191804	Brake lever retracting spring .....	1	-	-	-	-	
191803	Brake lever retracting spring pin .....	1	-	-	-	-	
191045	Brake lever sector .....	1	-	-	-	-	
191046	Brake lever sector stud .....	2	-	-	-	-	
5504	Lockwasher 5/16" .....	4	-	-	-	-	
7005	Nut 5/16-24 .....	4	-	-	-	-	
5506	Lockwasher 3/8" .....	2	-	-	-	-	
7006	Nut 3/8-24 .....	2	-	-	-	-	
191052	Brake lever sector cover gasket .....	1	-	-	-	-	
191053	Brake lever sector cover and gasket assembly .....	1	-	-	-	-	
186595	Brake lever sector cover grommet assembly .....	1	-	-	-	-	
191044	Brake lever sector cover stud .....	2	-	-	-	-	
5506	Lockwasher 3/8" .....	2	-	-	-	-	
7006	Nut 3/8-24 .....	2	-	-	-	-	
5504	Lockwasher 5/16" .....	2	-	-	-	-	
7005	Nut 5/16-24 .....	2	-	-	-	-	
173863	Brake-front operating shaft .....	2	-	-	-	-	
148078	Brake-front operating shaft lever right .....	1	-	-	-	-	
148079	Brake-front operating shaft lever left .....	1	-	-	-	-	
7817	Clamp bolt 5/16-24 x 1-3/4" hex. hd. ....	4	-	-	-	-	
7005	Nut 5/16-24 .....	4	-	-	-	-	
5504	Lockwasher 5/16" .....	4	-	-	-	-	
146091	Brake-front operating shaft oil restriction .....	2	-	-	-	-	
138753	Brake-front operating shaft support arm right assembly .	1	-	-	-	-	
138754	Brake-front operating shaft support arm left assembly ..	1	-	-	-	-	
138891	Plug 5/16" expansion .....	2	-	-	-	-	
138898	Oil restriction (short) .....	2	-	-	-	-	
138897	Oil restriction (long) .....	2	-	-	-	-	
194992	Brake-front operating shaft support arm ball .....	2	-	-	-	-	
194960	Brake-front operating shaft support arm ball cap .....	2	-	-	-	-	
195900	Brake-front operating shaft support arm ball cap spring.	2	-	-	-	-	
148098	Brake-front operating shaft support arm ball oil retainer .....	2	-	-	-	-	
141960	Brake-front operating shaft support arm ball oil restriction .....	2	-	-	-	-	

Piece No.	Name	No. Required				
		903 906	1005 1006	1107 1108	1207 1208	1407 1408
145668	Brake-front operating shaft support arm bracket assembly	2	-	-	-	-
166870	Screw .....	4	-	-	-	-
5506	Lockwasher 3/8" .....	4	-	-	-	-
7106	Nut 3/8-24 castle .....	4	-	-	-	-
4290	Cotter pin 3/32 x 5/8" .....	4	-	-	-	-
138705	Brake-front operating shaft support arm bracket bushing.	4	-	-	-	-
138896	Brake-front operating shaft support arm bracket oil restriction .....	2	-	-	-	-
137974	Brake-front operating shaft support arm cap .....	2	-	-	-	-
7827	Screw 1/4-28 x 3/4" hex. hd. ....	4	-	-	-	-
5502	Lockwasher 1/4" .....	4	-	-	-	-
138706	Shim .002 .....	x	-	-	-	-
138707	Shim .005 .....	x	-	-	-	-
138708	Shim .015 .....	x	-	-	-	-
7826	Brake-front operating shaft support arm retaining screw 5/16-24 x 5/8" hex. hd. ....	2	-	-	-	-
137972	Washer .....	2	-	-	-	-
5504	Lockwasher 5/16" .....	2	-	-	-	-
138890	Oil retainer .....	2	-	-	-	-
140083	Brake-front operating shaft support arm spring washer ..	2	-	-	-	-
98264	Brake lining sets .....	1	-	-	-	-
203151	Brake pedal .....	1	-	-	-	-
202911	Brake pedal bushing .....	1	-	-	-	-
203153	Brake pedal lever .....	1	-	-	-	-
191035	Brake pedal lever connecting rod upper assembly .....	1	-	-	-	-
7515	Brake pedal lever connecting rod adjusting yoke end 5/16" .....	1	-	-	-	-
7005	Nut 5/16-24 .....	1	-	-	-	-
7525	Yoke end pin 5/16" .....	4	-	-	-	-
4290	Cotter pin 3/32 x 5/8" .....	4	-	-	-	-
190291	5/16" spring washer .....	1	-	-	-	-
191038	Brake pedal lever connecting rod lower assembly .....	1	-	-	-	-
178642	Yoke end adjusting 3/8" special .....	1	-	-	-	-
7006	Nut 3/8-24 .....	1	-	-	-	-
203145	Brake pedal to lever link .....	1	-	-	-	-
6160	Yoke end pin 5/16" .....	1	-	-	-	-
4290	Cotter pin 3/32 x 5/8" .....	1	-	-	-	-
190291	Yoke end pin spring washer 5/16" .....	1	-	-	-	-
203146	Brake pedal to lever link strap .....	2	-	-	-	-
6161	Yoke end pin 5/16" special .....	2	-	-	-	-
4290	Cotter pin 3/32 x 5/8" .....	2	-	-	-	-
190291	Yoke end pin spring washer 5/16" .....	2	-	-	-	-
202456	Brake pedal to lever pin .....	1	-	-	-	-
4306	Cotter pin 1/8 x 1" .....	1	-	-	-	-
3916	Washer 5/16" special .....	1	-	-	-	-
202927	Brake pedal lever spacer .....	1	-	-	-	-
4648	Brake pedal lever stop light switch pin .....	1	-	-	-	-
181402	Brake pedal pad assembly .....	1	-	-	-	-
177286	Brake pedal pad assembly (Extension type) .....	1	-	-	-	-
8043	Screw 5/16-24 x 1-1/4" hex. hd. ....	1	-	-	-	-
5504	Lockwasher 5/16" .....	1	-	-	-	-
7005	Nut 5/16-24 .....	1	-	-	-	-
169182	Brake pedal pad tread .....	1	-	-	-	-
202970	Brake pedal retracting spring .....	1	-	-	-	-
202987	Brake pedal retracting spring screw eye .....	1	-	-	-	-
191778	Brake shaft front assembly .....	1	-	-	-	-
191783	Brake shaft rear assembly .....	1	-	-	-	-
207040	Brake shaft rear anti-rattler spring .....	1	-	-	-	-
202243	Brake shaft rear anti-rattler spring clip .....	1	-	-	-	-
191781	Brake shaft front bushing .....	2	-	-	-	-



## SERVICE PARTS LIST—PACKARD TWELVE

Brake and Control 11

Piece No.	Name	No. Required				
		905 906	1005 1006	1107 1108	1207 1208	1407 1408
191015	Brake shaft rear bushing large .....	1	-	-	-	-
191014	Brake shaft rear bushing small .....	1	-	-	-	-
191777	Brake shaft bracket-right .....	1	-	-	-	-
191776	Brake shaft bracket-left .....	1	-	-	-	-
5919	Screw 3/8-24 x 1-3/4" hex. hd. ....	7	-	-	-	-
5506	Lockwasher 3/8" .....	8	-	-	-	-
7006	Nut 3/8-24 .....	8	-	-	-	-
7824	Screw 1/4-28 x 5/8" hex. hd. ....	3	-	-	-	-
5502	Lockwasher 1/4" .....	3	-	-	-	-
203506	Brake shaft bracket screw-long .....	1	-	-	-	-
191673	Brake shaft bracket cap-left .....	1	-	-	-	-
191674	Brake shaft bracket cap-right .....	1	-	-	-	-
191692	Brake shaft bracket gasket .....	2	-	-	-	-
191727	Brake shaft front lever center .....	1	-	-	-	-
7810	Clamp screw 5/16-24 x 1-1/4" hex. hd. ....	1	-	-	-	-
5504	Lockwasher 5/16" .....	1	-	-	-	-
5550	Key rectangular 1/4 x 5/16 x 1-1/4" .....	1	-	-	-	-
191697	Brake shaft lever .....	4	-	-	-	-
7810	Clamp screw 5/16-24 x 1-1/4" hex. hd. ....	4	-	-	-	-
5504	Lockwasher 5/16" .....	4	-	-	-	-
5548	Key Whitney No. C (Woodruff system) .....	4	-	-	-	-
191708	Brake shaft rear lever center .....	1	-	-	-	-
7810	Clamp screw 5/16-24 x 1-1/4" hex. hd. ....	1	-	-	-	-
5504	Lockwasher 5/16" .....	1	-	-	-	-
5550	Key rectangular 1/4 x 5/16 x 1-1/4" .....	1	-	-	-	-
191805	Brake shaft rear retracting spring .....	1	-	-	-	-
164636	Brake shoe (Primary) assembly .....	4	-	-	-	-
164635	Brake shoe (Auxiliary) assembly .....	4	-	-	-	-
163436	Brake shoe anchor pin .....	8	-	-	-	-
4334	Cotter pin 3/16 x 1-3/4" .....	8	-	-	-	-
5629	Lockwasher 3/4" .....	8	-	-	-	-
163464	Nut (Special) .....	8	-	-	-	-
163463	Brake shoe anchor pin washer steel .....	8	-	-	-	-
163468	Brake shoe anchor plate .....	4	-	-	-	-
163456	Brake shoe articulating pin .....	4	-	-	-	-
163465	Brake shoe adjusting cam .....	4	-	-	-	-
7008	Nut 1/2-20 .....	4	-	-	-	-
5510	Lockwasher 1/2" .....	4	-	-	-	-
303074	Brake shoe lining rivet .....	128	-	-	-	-
163434	Brake shoe (Primary and auxiliary) lining .....	8	-	-	-	-
164004	Brake shoe (Primary and auxiliary) spring .....	4	-	-	-	-
164637	Brake shoe (Secondary) assembly .....	4	-	-	-	-
179153	Brake shoe (Secondary) lining .....	4	-	-	-	-
164005	Brake shoe (Secondary) spring .....	4	-	-	-	-
163454	Brake shoe (Secondary) spring anchor .....	4	-	-	-	-
166832	Brake shoe (Secondary) spacer spring .....	4	-	-	-	-
163453	Brake shoe steady pin .....	4	-	-	-	-
4289	Cotter pin 3/32 x 1/2" .....	4	-	-	-	-
144567	Washer large .....	8	-	-	-	-
148085	Washer small .....	4	-	-	-	-
148074	Brake shoe steady pin spring .....	4	-	-	-	-
171944	Brake-front support plate-left assembly .....	1	-	-	-	-
171943	Brake-front support plate-right assembly .....	1	-	-	-	-
171948	Brake-rear support plate-left assembly (Used with standard rear axle) .....	1	-	-	-	-
171947	Brake-rear support plate-right assembly (Used with standard rear axle) .....	1	-	-	-	-
205688	Brake-rear support plate-left assembly (Used with angle set rear axle) .....	1	-	-	-	-

Piece No.	Name	No. Required				
		905 906	1005 1006	1107 1108	1207 1208	1407 1408
205689	Brake-rear support plate-right assembly (Used with angle set rear axle) .....	1	-	-	-	-
169171	Brake-front universal joint cover .....	2	-	-	-	-
169192	Brake-front universal joint cover cap .....	2	-	-	-	-
148073	Brake-front universal joint cover cap spring .....	2	-	-	-	-
148075	Brake-front universal joint cover cap spring retainer ..	2	-	-	-	-
163466	Lock .....	2	-	-	-	-
169311	Brake-front universal joint pivot .....	2	-	-	-	-
139086	Brake-front universal joint pivot pin .....	2	-	-	-	-
140075	Brake-front universal joint pivot pin lock pin .....	2	-	-	-	-
202899	Brake vacuum cylinder assembly .....	1	-	-	-	-
202904	Brake vacuum cylinder bracket .....	1	-	-	-	-
5907	Bolt long 5/16-24 x 1-3/4" .....	1	-	-	-	-
5566	Bolt short 5/16-24 x 1-1/8" .....	2	-	-	-	-
5504	5/16" lockwasher .....	3	-	-	-	-
7005	Nut 5/16-24 .... 00-C steel .....	3	-	-	-	-
6316	Brake vacuum cylinder to brake stud 3/8-16 x 2-5/32" ...	4	-	-	-	-
3877	Plain washer 3/8" .....	4	-	-	-	-
5506	Lockwasher 3/8" .....	4	-	-	-	-
7006	Nut 3/8-24 plain .....	4	-	-	-	-
202828	Brake vacuum cylinder connecting cable assembly (Used on 906 only) .....	1	-	-	-	-
202829	Brake vacuum cylinder connecting cable assembly (Used on 905 only) .....	1	-	-	-	-
7006	Nut 3/8-24 plain .....	1	-	-	-	-
7525	Yoke end pin 5/16" .....	1	-	-	-	-
4290	Cotter pin 3/32 x 5/8" .....	1	-	-	-	-
190291	5/16" spring washer .....	1	-	-	-	-
203302	Brake vacuum cylinder connecting cable pulley assembly .	1	-	-	-	-
7705	Screw No. 10-32 x 7/8" fill. hd. ....	2	-	-	-	-
5500	3/16" lockwasher .....	2	-	-	-	-
203134	Brake vacuum cylinder connecting cable retainer .....	1	-	-	-	-
6162	Screw .....	2	-	-	-	-
5500	Lockwasher No. 10 .....	2	-	-	-	-
202916	Brake vacuum valve assembly .....	1	-	-	-	-
202912	Brake vacuum valve adjusting yoke end .....	1	-	-	-	-
170074	Brake vacuum valve adjusting yoke lock nut .....	1	-	-	-	-
7525	Yoke end pin 5/16" .....	2	-	-	-	-
3908	Yoke end pin washer 5/16" .....	2	-	-	-	-
4290	Cotter pin 3/32 x 5/8" .....	2	-	-	-	-
190291	Spring washer 5/16" .....	2	-	-	-	-
202945	Brake vacuum valve to brake vacuum cylinder tube assembly .....	1	-	-	-	-
203182	Brake vacuum valve to brake vacuum cylinder tube clip ..	2	-	-	-	-
7710	Screw No. 10-32 x 5/8" fill. hd. ....	1	-	-	-	-
7003	Nut No. 10-32 .....	1	-	-	-	-
5500	Lockwasher No. 10 .....	1	-	-	-	-
202902	Brake vacuum valve to clutch control valve hose (19" long) .....	1	-	-	-	-
209028	Brake vacuum valve to clutch control valve hose (18" long) .....	1	-	-	-	-
202202	Brake vacuum valve to clutch control valve hose clamp ..	2	-	-	-	-
202902	Brake vacuum valve to vacuum cylinder hose-long (Used on 905 only) .....	1	-	-	-	-
202944	Brake vacuum valve to vacuum cylinder hose-long (Used on 906 only) .....	1	-	-	-	-
202470	Brake vacuum valve to vacuum cylinder hose-short .....	1	-	-	-	-
202202	Brake vacuum valve to vacuum cylinder hose clamp .....	4	-	-	-	-

Piece No.	Name	No. Required				
		905 906	1005 1006	1107 1108	1207 1208	1407 1408
<b>BRAKE</b>						
207560	Brake assembly-front right .....	-	1	1	-	-
223897	Brake assembly-front right .....	-	-	-	1	1
207559	Brake assembly-front left .....	-	1	1	-	-
223896	Brake assembly-front left .....	-	-	-	1	1
207562	Brake assembly-rear right .....	-	1	1	1	1
207561	Brake assembly-rear left .....	-	1	1	1	1
138917	Brake assembly front retaining bolt (Screw 5/16-24 x 15/16" hex. hd.) .....	-	16	16	16	16
7809	Screw 5/16-24 x 7/8" hex. hd. ....	-	8	4	4	4
5449	Screw 5/16-24 x 3/4" hex. hd. ....	-	-	4	4	4
5504	Lockwasher .....	-	24	24	24	24
7005	Nut 5/16-24 .....	-	16	16	16	24
209893	Brake cable and conduit assembly front .....	-	2	2	-	-
223652	Brake cable and conduit assembly front .....	-	-	-	2	2
197059	Brake cable and conduit assembly front clamp .....	-	4	4	4	4
7811	Bolt 5/16-24 x 1-3/8" hex. hd. ....	-	4	4	-	-
5390	Bolt 5/16-24 x 1-1/4" hex. hd. ....	-	-	-	3	3
7005	Nut 5/16-24 plain .....	-	4	4	3	3
5504	Lockwasher 5/16" std. ....	-	4	4	3	3
201031	Brake cable and conduit assembly front clamp spacer ....	-	4	4	-	-
225319	Brake cable and conduit assembly front clamp spacer ....	-	-	-	4	4
209899	Brake cable and conduit assembly rear (Used on 1006-1108)	-	2	2	-	-
209898	Brake cable and conduit assembly rear (Used on 1005-1107)	-	2	2	-	-
7828	Brake cable and conduit assembly rear clamp bolt 5/16-24 x 1-1/8" hex. hd. ....	-	2	2	-	-
5504	Lockwasher 5/16" std. ....	-	2	2	4	4
7005	Nut 5/16-24 plain .....	-	2	2	-	2
223648	Brake cable and conduit assembly-rear (Used on 1207-1407)	-	-	-	2	2
223649	Brake cable and conduit assembly-rear (Used on 1208-1408)	-	-	-	2	2
221509	Brake cable and conduit assembly-rear clamp .....	-	-	-	2	2
7826	Brake cable and conduit assembly-rear clamp screw 5/16-24 x 5/8" hex. hd. ....	-	-	-	4	4
5504	Lock washer 5/16" .....	-	-	-	4	4
201964	Brake cable and conduit assembly rear clip .....	-	2	2	-	-
7826	Bolt 5/16-24 x 5/8" hex. hd. ....	-	4	4	-	-
7005	Nut 5/16-24 plain .....	-	4	4	-	-
5504	Lockwasher 5/16" .....	-	4	4	-	-
7515	Brake connecting cable front and rear yoke end adjusting 5/16" .....	-	4	4	4	4
7005	Nut 5/16-24 plain .....	-	4	4	4	4
7525	Yoke end pin 5/16" std. ....	-	4	4	4	4
4289	Cotter pin 3/32 x 1/2" .....	-	4	4	4	4
197062	Brake cable front support .....	-	2	2	2	2
19898	Rubber bushing .....	-	2	2	2	2
5449	Bolt 5/16-24 x 3/4" hex. hd. ....	-	2	2	2	2
7005	Nut 5/16-24 plain .....	-	2	2	2	2
3909	Plain washer 5/16" special .....	-	2	2	2	2
5504	Lockwasher .....	-	2	2	2	2
223807	Brake lever .....	-	-	-	1	1
223810	Brake lever anchor pin .....	-	-	-	1	1
5508	Lockwasher 7/16" .....	-	-	-	1	1
5506	Lockwasher 3/8" .....	-	-	-	1	1
7007	Nut 7/16-20 .....	-	-	-	1	1
7006	Nut 3/8-24 .....	-	-	-	1	1
205948	Brake lever and bushing assembly .....	-	1	1	-	-
205727	Brake lever bushing .....	-	1	1	-	-
228790	Brake lever cable conduit assembly (Supersedes 223817)	-	-	-	1	1
7515	Yoke end adjusting 5/16" .....	-	-	-	1	1

Piece No.	Name	No. Required				
		905 906	1005 1006	1107 1108	1207 1208	1407 1408
7005	Nut 5/16-24 .....	-	-	-	1	1
228791	Brake lever cable conduit and adjusting yoke end assembly (Supersedes 223816) .....	-	-	-	1	1
7525	Yoke end pin .....	-	-	-	1	1
190291	Yoke end pin spring washer .....	-	-	-	1	1
4290	Cotter pin 3/32 x 5/8" .....	-	-	-	1	1
228850	Brake lever cable and conduit to dash clip (Supersedes 223814) .....	-	-	-	1	1
5430	Screw 1/4-28 x 1/2" hex. hd. ....	-	-	-	1	1
5502	Lockwasher 1/4" .....	-	-	-	1	1
223818	Brake lever cable and conduit support-upper .....	-	-	-	1	1
223815	Brake lever cable and conduit support-lower .....	-	-	-	1	1
5449	Screw 5/16-24 x 3/4" hex. hd. ....	-	-	-	4	4
5504	Lockwasher .....	-	-	-	4	4
7005	Nut 5/16-24 .....	-	-	-	4	4
5575	Brake lever cable and conduit support clamp bolt .....	-	-	-	2	2
7005	Nut 5/16-24 .....	-	-	-	2	2
223811	Brake lever cable yoke end pin .....	-	-	-	1	1
4305	Cotter pin 1/8 x 7/8" .....	-	-	-	1	1
196913	Brake lever connecting cable and adjusting yoke end asb. 7515 Adjusting yoke end .....	-	1	1	-	-
7005	Nut 5/16-24 plain .....	-	1	1	-	-
190953	Yoke end pin-spring head .....	-	1	1	-	-
190291	Spring washer .....	-	1	1	-	-
4290	Cotter pin .....	-	1	1	-	-
202251	Brake lever dust washer .....	-	1	1	-	-
197064	Brake lever insulator-body to frame .....	-	1	1	-	-
225946	Brake lever latch .....	-	-	-	1	1
190191	Spring washer 3/8" .....	-	-	-	1	1
223801	Brake lever latch connecting rod .....	-	-	-	1	1
225490	Brake lever latch connecting rod retaining ring .....	-	-	-	1	1
4280	Brake lever latch connecting rod cotter pin 1/16 x 1/2".	-	-	-	1	1
223802	Brake lever latch operating handle assembly .....	-	-	-	1	1
194732	Spring washer 1/4" .....	-	-	-	1	1
223805	Brake lever latch operating handle pin .....	-	-	-	1	1
228702	Brake lever latch operating handle spring .....	-	-	-	1	1
223804	Brake lever latch operating handle spring retainer pin .	-	-	-	1	1
223812	Brake lever latch pin .....	-	-	-	1	1
223616	Brake lever latch retaining ring .....	-	-	-	1	1
219518	Brake lever latch rod assembly .....	-	1	1	-	-
101808	Brake lever latch rod knob .....	-	1	1	-	-
101810	Brake lever latch rod spring .....	-	1	1	-	-
205941	Brake lever pedal shaft spring .....	-	1	1	-	-
205940	Brake lever pedal shaft spring cup washer .....	-	1	1	-	-
223831	Brake lever retaining washer .....	-	-	-	1	1
196969	Brake lever retracting spring .....	-	1	1	-	-
191803	Brake lever retracting spring pin .....	-	1	1	-	-
7005	Nut 5/16-24 plain std. ....	-	1	1	-	-
5004	Lockwasher 5/16" std. ....	-	1	1	-	-
197057	Brake lever sector .....	-	1	1	-	-
223800	Brake lever sector .....	-	-	-	1	1
5483	Screw 5/16-24 x 3/4" .....	-	2	2	-	-
7005	Nut 5/16-24 plain .....	-	2	2	-	-
5504	Lockwasher 5/16" std. ....	-	2	2	-	-
4164	Brake lever sector rivet .....	-	-	-	2	2
228688	Brake lever support (Supersedes 223832) .....	-	-	-	1	1
228693	Brake lever support sector and anchor pin assembly (Supersedes 223833) .....	-	-	-	1	1
6039	Screw 5/16-24 x 11/16" hex. hd. ....	-	-	-	2	2
7809	Screw 5/16-24 x 7/8" hex. hd. ....	-	-	-	1	1

Piece No.	Name	No. Required				
		905 906	1005 1006	1107 1108	1207 1208	1407 1408
5504	Lockwasher 5/16" .....	-	-	-	3	3
7005	Nut 5/16-24 .....	-	-	-	3	3
98267	Brake lining set - complete .....	-	1	1	1	1
98289	Brake lining set - Front wheels only .....	-	1	1	1	1
98292	Brake lining set - Rear wheels only .....	-	1	1	1	1
207060	Brake lever splasher assembly .....	-	1	1	-	-
197053	Brake lever splasher gasket-long .....	-	1	1	-	-
197052	Brake lever splasher gasket-short .....	-	2	2	-	-
210733	Brake lever splasher liner-front .....	-	1	1	-	-
210734	Brake lever splasher liner-rear .....	-	1	1	-	-
5430	Brake lever splasher retainer screw 1/4-28 x 1/2" .....	-	2	2	-	-
9004	Nut 1/4-28 plain .....	-	2	2	-	-
5502	Lockwasher 1/4" std. ....	-	2	2	-	-
223612	Brake pedal assembly .....	-	-	-	1	1
207723	Brake pedal .....	-	1	1	-	-
207725	Brake pedal bushing .....	-	1	1	1	1
202242	Brake pedal connecting rod assembly upper .....	-	1	1	1	-
230254	Brake pedal connecting rod assembly upper .....	-	-	-	-	1
202241	Brake pedal connecting rod assembly lower .....	-	1	1	1	-
230253	Brake pedal connecting rod assembly lower .....	-	-	-	-	1
202239	Brake pedal connecting rod screw .....	-	4	4	4	4
5506	Lockwasher 3/8" .....	-	4	4	4	4
202056	Spring washer .....	-	4	4	4	4
7006	Nut 3/8-24 .....	-	4	4	4	4
202333	Washer .....	-	4	4	4	4
207761	Brake pedal lever .....	-	1	1	1	1
202253	Brake pedal lever retaining ring .....	-	1	1	-	-
207741	Brake pedal to lever link and bushing assembly .....	-	1	1	1	1
205225	Brake pedal to lever link bushing .....	-	1	1	1	1
202238	Brake pedal to lever link retaining screw .....	-	1	1	1	1
5506	Lockwasher 3/8" std. ....	-	1	1	1	1
7006	Nut 3/8-24 plain std. ....	-	1	1	1	1
207726	Brake pedal to lever link strap .....	-	2	2	2	2
6161	Yoke end pin-special .....	-	1	1	1	1
4290	Cotter pin 3/32 x 5/8" .....	-	1	1	1	1
190291	Yoke end pin spring washer .....	-	1	1	1	1
207744	Brake pedal to lever pin .....	-	1	1	1	1
4292	Cotter pin 3/32 x 7/8" .....	-	1	1	1	1
190912	Brake pedal lever spring washer .....	-	2	2	2	-
181402	Brake pedal pad assembly .....	-	1	1	1	1
8043	Screw 5/16-24 x 1-1/4" hex. hd. ....	-	1	1	1	1
5504	Lockwasher 5/16" std. ....	-	1	1	1	1
7005	Nut 5/16-24 plain .....	-	1	1	1	1
169182	Brake pedal pad tread .....	-	1	1	1	1
196942	Brake pedal retracting spring .....	-	1	1	-	-
223628	Brake pedal retracting spring .....	-	-	-	1	1
209124	Brake pedal retracting spring clip .....	-	1	1	-	-
207827	Brake pedal retracting spring pin .....	-	1	1	-	-
225248	Brake pedal retracting spring pin .....	-	-	-	1	1
4290	Cotter pin .....	-	1	1	1	1
210278	Brake shaft .....	-	1	1	1	1
205654	Brake shaft anti-rattler spring .....	-	2	2	2	2
202249	Brake shaft anti-rattler spring pin .....	-	2	2	2	2
207213	Brake shaft bracket-outer left .....	-	1	1	-	-
207212	Brake shaft bracket-outer right .....	-	1	1	-	-
221278	Brake shaft bracket-right .....	-	-	-	1	1
221279	Brake shaft bracket-left .....	-	-	-	1	1
7872	Screw 3/8-24 x 3/4" .....	-	4	4	4	4
5506	Lockwasher 3/8" std. ....	-	4	4	4	1
7006	Nut 3/8-24 plain .....	-	4	4	4	4



Piece No.	Name	No. Required				
		901 906	1005 1006	1107 1108	1207 1208	1407 1408
207648	Brake shaft lever-inner .....	-	1	1	1	1
7822	Clamp screw 3/8-24 x 1-1/2" hex. hd. ....	-	1	1	1	1
5506	Lockwasher 3/8" std. ....	-	1	1	1	1
207753	Brake shaft lever inner stop pin .....	-	1	1	1	1
5506	Lockwasher 3/8" std. ....	-	1	1	1	1
7006	Nut 3/8-24 plain std. ....	-	1	1	1	1
197065	Brake shaft lever inner key .....	-	1	1	1	1
207715	Brake shaft lever outer right .....	-	1	1	1	1
207714	Brake shaft lever-outer left .....	-	1	1	-	-
223588	Brake shaft lever-outer left .....	-	-	-	1	1
7808	Clamp screw 5/16-24 x 1-15/16" .....	-	2	2	2	2
5504	Lockwasher 5/16" std. ....	-	2	2	2	2
7005	Nut 5/16-24 plain .....	-	2	2	2	2
197065	Key .....	-	2	2	2	2
209950	Brake shaft spacer .....	-	1	1	1	1
209951	Brake shaft spring .....	-	1	1	1	1
210220	Brake shoe actuating cam arm spring .....	-	4	4	4	4
210277	Brake shoe actuating cam and return spring arm right assembly .....	-	2	2	2	2
210276	Brake shoe actuating cam and return spring arm left assembly .....	-	2	2	2	2
209856	Brake shoe adjusting nut screw .....	-	4	4	4	4
210224	Brake shoe adjusting screw .....	-	4	4	4	4
203902	Brake shoe adjusting screw spring .....	-	4	4	4	4
210309	Brake shoe anchor pin .....	-	4	4	4	4
202715	Brake shoe anchor pin lockwasher .....	-	4	4	4	4
7012	Nut 3/4-16 .....	-	4	4	4	4
213449	Brake shoe anchor pin spring upper .....	-	4	4	4	4
213448	Brake shoe anchor pin spring lower .....	-	4	4	4	4
202699	Brake shoe eccentric assembly .....	-	4	4	4	4
209930	Brake shoe guide plate .....	-	4	4	4	4
210776	Brake shoe hold down spring .....	-	16	16	16	16
202721	Brake shoe hold down spring cup inner .....	-	16	16	16	16
202747	Brake shoe hold down spring cup outer .....	-	16	16	16	16
209852	Brake shoe hold down spring pin .....	-	16	16	16	16
210043	Brake shoe and lining assembly front right and rear right and left primary .....	-	3	3	3	3
210042	Brake shoe and lining assembly front right and rear right and left secondary .....	-	3	3	3	3
210041	Brake shoe and lining assembly front left primary .....	-	1	1	1	1
210040	Brake shoe and lining assembly front left secondary .....	-	1	1	1	1
209984	Brake shoe lining front right and rear right and left primary .....	-	3	3	3	3
203985	Brake shoe lining front right and rear right and left secondary .....	-	3	3	3	3
210001	Brake shoe lining front left primary .....	-	1	1	1	1
210002	Brake shoe lining front left secondary .....	-	1	1	1	1
202941	Brake shoe lining rivets .....	-	96	96	96	96
210207	Brake shoe operating cam lever .....	-	4	4	-	-
210281	Brake front support plate assembly-right .....	-	1	1	-	-
223903	Brake front support plate assembly-right .....	-	-	-	1	1
210280	Brake front support plate assembly-left .....	-	1	1	-	-
223902	Brake front support plate assembly-left .....	-	-	-	1	1
210283	Brake rear support plate assembly-right .....	-	1	1	1	1
210282	Brake rear support plate assembly-left .....	-	1	1	1	1
202625	Brake support plate cable bracket .....	-	4	4	4	4
7896	Screw 5/16-24 x 1/2" hex. hd. ....	-	8	8	8	8
5504	Lockwasher .....	-	8	8	8	8
202886	Brake support plate cable bracket screw plate .....	-	4	4	4	4
209636	Brake support plate water seal .....	-	4	4	4	4

## SERVICE PARTS LIST—PACKARD TWELVE

Brake 17

Piece No.	Name	No. Required				
		905 906	1005 1006	1107 1108	1207 1208	1407 1408
209681	Brake support plate water seal and brackets assembly ...	-	4	4	4	4
6349	Screw No. 10-32 x 1" fill. hd. ....	-	4	4	4	4
5500	Lockwasher No. 10 .....	-	4	4	4	4
5416	Nut No. 10-32 plain .....	-	4	4	4	4
231032	Nut No. 10-32 square .....	-	-	-	-	4
210808	Brake vacuum control valve .....	-	1	1	-	-
210039	Brake vacuum control valve connection .....	-	1	1	-	-
4559	Plug .....	-	1	1	-	-
210066	Brake vacuum control valve to cylinder valve tube assembly .....	-	1	1	-	-
6378	Flared tube union nut .....	-	1	1	-	-
209987	Brake vacuum control valve to cylinder valve tube assembly clip .....	-	1	1	-	-
167261	Brake vacuum control valve to cylinder valve tube assembly clip screw No. 10 .....	-	1	1	-	-
5402	Flared tube elbow .....	-	1	1	-	-
210052	Brake vacuum control valve to dash bracket .....	-	1	1	-	-
5229	Flat head screw 1/4-28 x 1-3/8" .....	-	2	2	-	-
6322	Lockwasher 5/8" Shakeproof .....	-	1	1	-	-
5502	Lockwasher 1/4" .....	-	2	2	-	-
7004	Nut 1/4-28 .....	-	2	2	-	-
6321	Nut 5/8-18 special .....	-	1	1	-	-
210050	Brake vacuum control valve universal joint flange .....	-	1	1	-	-
5310	Brake vacuum control valve universal joint flange screw No. 8-32 round hd. ....	-	1	1	-	-
5861	Lockwasher .....	-	1	1	-	-
5435	Washer .....	-	1	1	-	-
209917	Brake vacuum control valve universal joint flange screw washer special .....	-	1	1	-	-
207819	Brake vacuum cylinder assembly (For repairs, consult Bragg-Kleisrath Corp., South Bend, Ind., or nearest representative) .....	-	1	1	1	1
207682	Brake vacuum cylinder bracket-long (Used on 1005-1107- 1207-1407) .....	-	1	1	1	1
207683	Brake vacuum cylinder bracket-long (Used on 1006-1108- 1208-1408) .....	-	1	1	1	1
207674	Brake vacuum cylinder bracket-short (Used on 1005-1107- 1207-1407) .....	-	1	1	1	1
207675	Brake vacuum cylinder bracket-short (Used on 1006-1108- 1208-1408) .....	-	1	1	1	1
5449	Bolt 5/16-24 x 3/4" hex. hd. ....	-	4	4	4	4
5504	Lockwasher 5/16" .....	-	4	4	4	4
7005	Nut 5/16-24 .....	-	4	4	4	4
6016	Stud 3/8-16 x 1-9/32" .....	-	4	4	4	4
5506	Lockwasher 3/8" .....	-	4	4	4	4
7006	Nut 3/8-24 plain .....	-	4	4	4	4
207686	Brake vacuum cylinder connecting cable assembly (Used on 1006-1108-1208-1408) .....	-	1	1	1	1
207685	Brake vacuum cylinder connecting cable assembly (Used on 1005-1107-1207-1407) .....	-	1	1	1	1
7006	Nut 3/8-24 plain .....	-	1	1	1	1
7525	Yoke end pin 5/16" .....	-	1	1	1	1
4290	Cotter pin 3/32 x 5/8" .....	-	1	1	1	1
190291	Spring washer 5/16" .....	-	1	1	1	1
213186	Brake vacuum cylinder connecting cable pulley and bushing assembly .....	-	1	1	1	1
203504	Brake vacuum cylinder connecting cable pulley bushing ..	-	1	1	1	1
209128	Brake vacuum cylinder connecting cable pulley pin .....	-	1	-	-	-
215221	Brake vacuum cylinder connecting cable pulley pin (1-1/8" long overall) .....	-	-	1	1	-

Piece No.	Name	No. Required				
		905 906	1005 1006	1107 1108	1207 1208	1407 1408
228655	Brake vacuum cylinder connecting cable pulley pin (1-3/16" long overall) .....	-	-	1	1	1
4291	Cotter pin 3/32 x 3/4" .....	-	1	1	1	1
207750	Spring washer (Use with pin 1-3/16" long) .....	-	-	-	1	2
209122	Brake vacuum cylinder connecting cable pulley bracket ..	-	1	-	-	-
215217	Brake vacuum cylinder connecting cable pulley bracket ..	-	-	1	-	-
223627	Brake vacuum cylinder connecting cable pulley bracket ..	-	-	-	1	1
5502	Lockwasher 1/4" std. ....	-	2	2	3	3
7824	Screw 5/16-24 x 5/8" hex. hd. ....	-	2	2	3	3
7004	Nut 5/16-24 hex. hd. ....	-	-	2	3	3
209125	Brake vacuum cylinder to vacuum valve tube assembly (Used on 1005-1107-1207-1407) .....	-	1	1	1	1
209126	Brake vacuum cylinder to vacuum valve tube assembly (Used on 1006-1108-1208-1408) .....	-	1	1	1	1
6259	Connection 1/2" flared tube inverted (Weatherhead) .	-	1	1	1	1
6263	Nut 1/2" tube .....	-	1	1	1	1
201183	Brake vacuum dash connection and vacuum control valve tube assembly .....	-	1	1	-	-
5578	Screw 5/16-24 x 7/8" hex. hd. ....	-	1	1	-	-
5504	Lockwasher 5/16" std. ....	-	1	1	-	-
114514	Brake vacuum dash connection and vacuum control valve tube assembly washer 25/64-3/4 x 5/32" .....	-	1	1	-	-
210068	Brake vacuum dash connection to vacuum control valve tube assembly .....	-	1	1	-	-
5465	Union nut .....	-	1	1	-	-
202916	Brake vacuum valve assembly (Repair parts not furnished, return defective assembly to factory).....	-	1	1	1	1
202912	Brake vacuum valve adjusting yoke end .....	-	1	1	1	1
170074	Brake vacuum valve adjusting yoke lock nut .....	-	1	1	1	1
7525	Yoke end pin 5/16" .....	-	2	2	2	2
4290	Cotter pin 3/32 x 5/8" .....	-	2	2	2	2
190291	Spring washer 5/16" .....	-	2	2	2	2
3908	Washer plain 5/16" "Y" std. ....	-	2	2	2	2
207776	Brake vacuum valve to brake vacuum cylinder hose .....	-	1	1	1	2
207762	Brake vacuum valve to brake vacuum cylinder hose clip ..	-	1	1	1	1
7710	Screw No. 10-32 x 5/8" fill. hd. ....	-	1	1	1	1
7003	Nut No. 10-32 .....	-	1	1	1	1
5500	Lockwasher No. 10 .....	-	1	1	1	1
207776	Brake vacuum valve to dash connection hose .....	-	1	1	1	2
203860	Brake vacuum valve to dash connection hose clamp-front .	-	1	-	-	-
215649	Brake vacuum valve to dash connection hose clamp-front assembly .....	-	-	1	-	-
215648	Brake vacuum valve to dash connection hose clamp-rear assembly .....	-	1	1	-	-
203187	Brake vacuum valve dash connection to motor intake manifold tube assembly (For the 12th and 14th tube - See motor vacuum check valve body and tube assembly ..	-	1	1	-	-
203178	Brake vacuum valve dash connection to motor intake manifold tube union .....	-	1	1	-	-
203177	Brake vacuum valve dash connection to motor intake manifold tube union nut .....	-	1	1	-	-
5502	Stud lockwasher .....	-	1	3	-	-
7004	Stud nut 1/4-28 .....	-	1	3	-	-
202572	Brake vacuum valve dash connection to motor intake manifold tube flange gasket .....	-	1	1	-	-
207776	Brake vacuum valve hose .....	-	-	-	2	2
215648	Brake vacuum valve hose clamp assembly .....	-	-	-	3	3
215649	Brake vacuum valve hose clamp assembly .....	-	-	-	1	1
225406	Brake vacuum valve hose to manifold tube junction .....	-	-	-	1	1
215648	Brake vacuum valve to vacuum cylinder hose clamp .....	-	-	2	-	-

Piece No.	Name	No. Required				
		905 906	1005 1006	1107 1108	1207 1208	1407 1408
<b>BUMPER</b>						
191393	Bumper assembly-rear .....	1	-	-	-	-
205674	Bumper assembly-rear .....	-	1	-	-	-
215563	Bumper assembly-rear .....	-	-	1	-	-
223601	Bumper assembly-rear (Not used with bodies 838-839) ....	-	-	-	1	-
225945	Bumper assembly-rear (Used with bodies 838-839) .....	-	-	-	1	-
191938	Bumper assembly-rear (Use with side wheel carrier) .....	1	-	-	-	-
209421	Bumper assembly-rear (Use with side wheel carrier) .....	-	1	-	-	-
215566	Bumper assembly-rear (Use with side wheel carrier) .....	-	-	1	-	-
223602	Bumper assembly-rear (Use with side wheel carrier) .....	-	-	-	1	-
194071	Bumper and stabilizer assembly-front (Not used on bodies 630-1-9-641-3-7) .....	1	1	-	-	-
213809	Bumper and stabilizer assembly-front (Used only on bodies 630-1-9-641-3-7-4000-1-2-3) .....	-	1	-	-	-
215693	Bumper and stabilizer assembly-front (Used on bodies 732-3-4-5-6-7-8) .....	-	-	1	-	-
215694	Bumper and stabilizer assembly-front (Used on bodies 730-1-9-741-3-7) .....	-	-	1	-	-
215692	Bumper and stabilizer assembly-front (Used on bodies D858-D859) .....	-	-	1	-	-
215002	Bumper and stabilizer assembly-front (Used on bodies D758-D759) .....	-	1	-	-	-
228928	Bumper and stabilizer assembly-front (Special export) (Use with front axle spring 221788-207239) (Supersedes 216992) .....	-	-	1	1	-
223866	Bumper front and stabilizer assembly (Used on bodies 832-3-6-7-8) .....	-	-	-	1	-
231031	Bumper and stabilizer assembly-front (Used on bodies 830-1-9-21-27-873) (Supersedes 228948 and 228964) ....	-	-	-	1	-
228949	Bumper and stabilizer assembly-front (Used on bodies L194-L195-834-835) .....	-	-	-	1	-
191922	Bumper clamp plate-front .....	2	2	2	-	-
191437	Bumper clamp plate-front .....	-	-	-	2	-
191791	Bumper clamp plate-front cover .....	1	1	1	-	-
223490	Bumper clamp plate-front cover .....	-	-	-	1	-
191810	Bolt (1-1/2" long under head) .....	4	4	4	4	-
191174	Bolt (2-5/8" long under head) .....	-	-	-	4	-
5508	Lockwasher 7/16" .....	4	4	4	4	-
191437	Bumper clamp plate rear .....	2	2	2	2	-
191439	Bumper clamp plate rear cover .....	2	2	2	-	-
223864	Bumper clamp plate rear cover .....	-	-	-	2	-
191174	Bolt .....	4	4	4	-	-
191810	Bolt .....	-	-	-	4	-
5508	Lockwasher std. 7/16" .....	4	4	4	4	-
223493	Bumper front to fender grommet .....	-	-	-	2	-
228530	Bumper front clamp stud .....	-	-	-	4	-
228531	Bumper front clamp stud nut .....	-	-	-	4	-
194551	Bumper front end stabilizer bolt .....	2	2	-	-	-
230190	Bumper front end stabilizer stud .....	-	-	2	2	-
230191	Bumper front end stabilizer stud nut--upper .....	2	2	-	2	-
302620	Bumper front end stabilizer stud nut--lower .....	-	-	-	2	-
5961	Lockwasher 1/2" Shakeproof .....	2	-	-	-	-
3884	washer 1/2" .....	-	-	2	2	-
210408	washer .....	-	2	2	2	-
215697	Bumper front end stabilizer cap upper assembly .....	-	-	2	2	-
215700	Bumper front end stabilizer cap upper spring .....	-	-	2	2	-
194585	Bumper front end stabilizer cover-lower assembly .....	2	2	-	-	-
194552	Bumper front end stabilizer cover-upper .....	2	2	-	-	-
215696	Bumper front end stabilizer retainer and cap lower asb..	-	-	2	2	-

Piece No	Name	No. Required				
		905 906	1005 1006	1107 1108	1207 1208	1407 1408
194553	Bumper front stabilizer spring weight and retainer assembly (Used with bodies 832-3-6-7-8-30-31-39-21-27)	-	-	-	2	-
228960	Bumper front stabilizer spring weight and retainer assembly (Used with bodies 834-5-1194-1195)	-	-	-	2	-
228961	Bumper front stabilizer spring weight and retainer assembly (Used with body 873)	-	-	-	2	-
215001	Bumper front stabilizer spring weight and retainer assembly (Used with bodies D758-D759-D858-D859)	-	2	2	-	-
194553	Bumper front stabilizer spring weight and retainer assembly (Not used on D758-D759-D858-D859)	2	2	2	-	-
194549	Bumper front end stabilizer spring-inner (Not used on bodies 630-1-9-641-3-7-732-3-4-5-6-7-8)	4	4	4	-	-
213808	Bumper front end stabilizer spring-inner (Used only on bodies 630-1-9-641-3-7-730-1-9-741-3-7-D758-9-D858-9-4000-1-2-3-821-27-31-39-830-34-35)	-	4	4	4	-
194548	Bumper front end stabilizer spring-outer (Not used on bodies 630-1-9-641-3-7-732-3-4-5-6-7-8)	4	4	4	-	-
213807	Bumper front end stabilizer spring-outer (Used only on bodies 630-1-9-641-3-7-730-1-9-741-3-7-D758-9-D858-9-4000-1-2-3-821-27-31-39-830)	-	4	4	4	-
194549	Bumper front end stabilizer spring-inner (Used on bodies 832-33-34-35-36-37-38-873)	-	-	-	4	-
194548	Bumper front end stabilizer spring-outer (Used on bodies 832-33-34-35-36-37-38-873)	-	-	-	4	-
216991	Bumper front end stabilizer spring-outer (Spec. export) (Use with bumper 216992-221788-207239-221766)	-	-	4	4	-
228536	Bumper front support bracket assembly	-	-	-	1	-
223605	Bumper rear support bracket	-	-	-	2	-
7886	Clamp screw 7/16-20 x 1-3/4"	-	-	-	2	-
5508	Lockwasher 7/16"	-	-	-	2	-
223608	Bumper rear support bracket to body grommet	-	-	-	2	-
5561	Bumper rear support to frame bolt 7/16-20 x 1-7/8" hex. hd.	-	-	-	2	-
7007	Nut 7/16-20	-	-	-	2	-
5508	Lockwasher 7/16"	-	-	-	2	-
3883	Washer 7/16"	-	-	-	2	-
191431	Bumper rear support plate	2	2	2	-	-

## BUMPER

231031	Bumper front and stabilizer assembly (Use with bodies 921-31-27-73-930-L294) (Supersedes 230393)	-	-	-	-	1
223866	Bumper front and stabilizer assembly (Use with bodies 932-33-36-37-38)	-	-	-	-	1
228949	Bumper front and stabilizer assembly (Use with bodies 934-935)	-	-	-	-	1
231253	Bumper front and stabilizer assembly (Use with body 939) (Supersedes 230392)	-	-	-	-	1
230391	Bumper front and stabilizer assembly (Use with body 927)	-	-	-	-	1
231239	Bumper rear and stabilizer assembly (Used on 973-L294-L295) (Rear carrier)	-	-	-	-	1
231240	Bumper rear and stabilizer assembly (Used on 973-L294-L295) (Side carrier)	-	-	-	-	1
231241	Bumper rear and stabilizer asb. (Used on 927) (Rear Car.)	-	-	-	-	1
231242	Bumper rear and stabilizer asb. (Used on 927) (Side Car.)	-	-	-	-	1
231248	Bumper rear and stabilizer asb. (Used on 921-931) (Rear carrier)	-	-	-	-	1
231249	Bumper rear and stabilizer asb. (Used on 921-931) (Side carrier)	-	-	-	-	1
231363	Bumper rear and stabilizer asb. (Used on 939) (Rear Car.)	-	-	-	-	1
231364	Bumper rear and stabilizer asb. (Used on 939) (Side Car.)	-	-	-	-	1
225945	Bumper rear assembly (Use with bodies 93839)	-	-	-	-	1
223602	Bumper rear assembly (Side wheel carrier)	-	-	-	-	1
223601	Bumper rear assembly (Use with bodies 921-27-30-31-32-33-34-35-36-37-973-L294-L295)	-	-	-	-	1
191437	Bumper front clamp plate	-	-	-	-	2
223490	Bumper front clamp plate cover	-	-	-	-	1
191810	Bumper front clamp plate cover bolt (1-1/2" long under hd.)	-	-	-	-	4
191174	Bumper front clamp plate cover bolt (2-5/8" long under hd.)	-	-	-	-	4
5508	Lockwasher	-	-	-	-	2
223492	Bumper front to fender grommet	-	-	-	-	2
223491	Bumper front support bracket	-	-	-	-	2



BUMPER AND STABILIZER CHART

Bumper & Stabilizer #	Impact Bar	Back Bar	Center Clamp	Back Clamp		Side Clamp	Center Clamp Acorn Bolt	Side Clamp Acorn Bolt	Cushion Bar		Stabilizer Parts
				Right	Left				Right	Left	
230391	0232427	0232428	0232424	0232450	0232451	0232423	0232425	0232426	0232429	0232430	*
223866	0232427	0232428	0232424	0232450	0232451	0232423	0232425	0232426	0232429	0232430	*
231031	0232427	0232428	0232424	0232450	0232451	0232423	0232425	0232426	0232429	0232430	*
228949	0232427	0232428	0232424	0232450	0232451	0232423	0232425	0232426	0232429	0232430	*
231253	0232427	0232428	0232424	0232450	0232451	0232423	0232425	0232426	0232429	0232430	*
231239	0232437	0232438	0232424	0232450	0232451	0232423	0232425	0232426	0232439	0232439	*
231241	0232437	0232438	0232424	0232450	0232451	0232423	0232425	0232426	0232439	0232439	*
231248	0232437	0232438	0232424	0232450	0232451	0232423	0232425	0232426	0232439	0232439	*
231363	0232434	0232435	0232424	0232450	0232451	0232423	0232425	0232426	0232436	0232436	*
231242	0232431	0232432	0232424	0232450	0232451	0232423	0232425	0232426	0232433	0232433	*
231364	0232431	0232432	0232424	0232450	0232451	0232423	0232425	0232426	0232433	0232433	*
231240	0232431	0232432	0232424	0232450	0232451	0232423	0232425	0232426	0232433	0232433	*
231249	0232431	0232432	0232424	0232450	0232451	0232423	0232425	0232426	0232433	0232433	*

\* Note: See Stabilizer Chart.

BUMPER ASSEMBLY CHART

		Pc. No. 223601	Pc. No. 223602	Pc. No. 225945
<b>Detail Parts:</b>				
	Qty.			
Impact bar .....	1	0232444	0232440	0232442
Back bar .....	1	0232445	0232441	0232443
Center clamp .....	1	0232424	0232424	0232424
Center clamp acorn bolt .....	1	0232425	0232425	0232425
Back clamp right .....	1	0232450	0232450	0232450
Back clamp left .....	1	0232451	0232451	0232451
Side clamp .....	2	0232423	0232423	0232423
Side clamp acorn bolt .....	2	0232426	0232426	0232426
Cushion bar .....	2	0232439	0232433	0232436
Eye bolt .....	2	0232446	0232446	0232446
Eye cap-top .....	2	0232447	0232447	0232447
Eye cap-bottom .....	2	0232448	0232448	0232448
Eye cap-bottom-cover .....	2	0232449	0232449	0232449

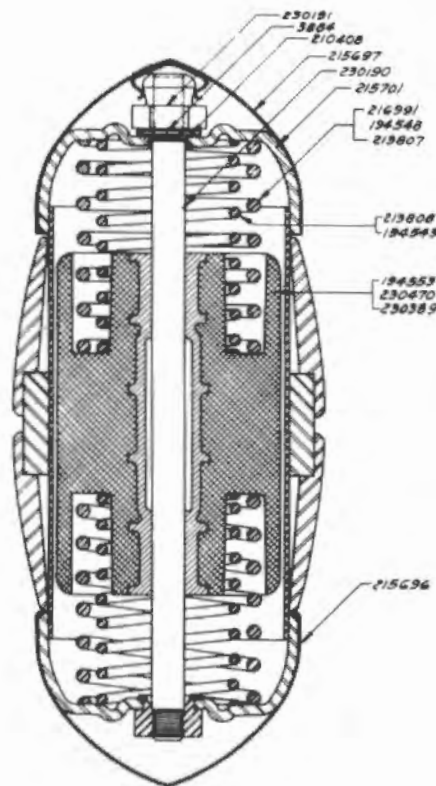

BUMPER STABILIZER CHART

Bumper & Stabilizer #	Pc. #	Weight wt.	Springs		Color	Cap Upper	Cap Lower	Stud	Washer		Stud Nut
			Inner	Outer					1/2	9/16	
230391	230389	11#	213808	213807	Blue	215697	215696	230190	3884	210408	230191
231242	194553	11# 7 oz	194549	216991	Red	215697	215696	230190	3884	210408	230191
231031	194553	11# 7 oz	213808	213807	Blue	215697	215696	230190	3884	210408	230191
231241	194553	11# 7 oz	194549	216991	Red	215697	215696	230190	3884	210408	230191
231253	230389	11#	213808	216991	Red	215697	215696	230190	3884	210408	230191
223866	194553	11# 7 oz	194549	194548	Black	215697	215696	230190	3884	210408	230191
231248	194553	11# 7 oz	194549	213807	Blue	215697	215696	230190	3884	210408	230191
231363	230389	11#	194549	213807	Black	215697	215696	230190	3884	210408	230191
231239	230389	11#	194549	213807	Blue	215697	215696	230190	3884	210408	230191
228949	228960	8#	194549	194548	Black	215697	215696	230190	3884	210408	230191
231240	230389	11#	194549	213807	Blue	215697	215696	230190	3884	210408	230191
231249	194553	11# 7 oz	194549	213807	Blue	215697	215696	230190	3884	210408	230191
231364	230389	11#	194549	194548	Black	215697	215696	230190	3884	210408	230191



0232449



0232447



0232448



0232425  
0232426



0232450  
0232451



0232446

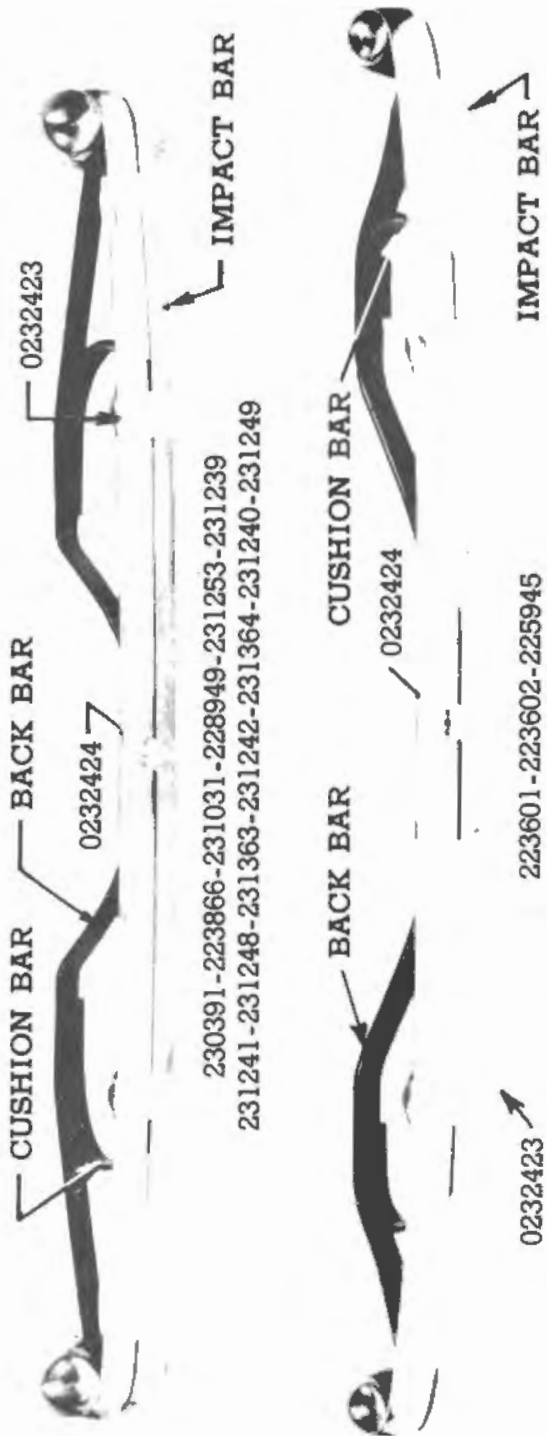

Piece No.	Name	No. Required				
		905 906	1005 1006	1107 1108	1207 1208	1407 1408
191437	Bumper rear clamp plate .....	-	-	-	-	2
223864	Bumper rear clamp plate cover .....	-	-	-	-	2
191810	Bumper rear clamp plate cover bolt .....	-	-	-	-	4
5508	Lockwasher 7/16" .....	-	-	-	-	4
230190	Bumper front stabilizer stud .....	-	-	-	-	2
3884	Washer 1/2 .....	-	-	-	-	2
210408	Washer .....	-	-	-	-	2
302620	Nut-lower .....	-	-	-	-	2
230191	Nut-upper .....	-	-	-	-	2
194548	Bumper front stabilizer spring outer (Used with bodies 932-33-34-35-36-37-38-39-L294) .....	-	-	-	-	4
213807	Bumper front stabilizer spring outer (Used with bodies 921-27-31-73-L295-930) .....	-	-	-	-	4
223608	Bumper rear support bracket to body grommet .....	-	-	-	-	2
223605	Bumper rear support bracket .....	-	-	-	-	2
7886	Clamp screw 7/16-20 x 1-3/4" .....	-	-	-	-	2
5508	Lockwasher 7/16" .....	-	-	-	-	2
5561	Bumper rear support to frame bolt 7/16-20 x 1-7/8" hex. hd. ....	-	-	-	-	2
7007	Nut 7/16-20 .....	-	-	-	-	2
5508	Lockwasher 7/16" .....	-	-	-	-	2
3883	Washer 7/16" .....	-	-	-	-	2
215697	Bumper front stabilizer cap upper assembly .....	-	-	-	-	2
215700	Bumper front stabilizer cap upper spring .....	-	-	-	-	2
215696	Bumper front stabilizer retainer and cap lower assembly.	-	-	-	-	2
213808	Bumper front stabilizer spring--inner (Used on bodies 921-27-31-73-L295-930) .....	-	-	-	-	4
194549	Bumper front stabilizer spring--inner (Used on bodies 932-33-34-35-36-37-38-39-L294) .....	-	-	-	-	4
194553	Bumper front stabilizer spring weight and retainer asb. (Use with bodies 921-27-30-31-32-33-36-37-38-73) .....	-	-	-	-	2
228960	Bumper front stabilizer spring weight and retainer assembly (Use with bodies 934-935) .....	-	-	-	-	2
230389	Bumper front stabilizer spring weight and retainer assembly (Use with body L-295) .....	-	-	-	-	2
230470	Bumper front stabilizer spring weight and retainer assembly (Use with body 939) .....	-	-	-	-	2
230390	Bumper front stabilizer spring weight and retainer assembly (Use with body L-294) .....	-	-	-	-	2

BUMPER FRONT AND STABILIZER ASSEMBLY-CHART

CHASSIS	BODY MODEL	BUMPER FRONT AND STABILIZER ASSEMBLY	PC. NO'S	WEIGHT		OUTER SPRING		INNER SPRING	
				PC. NO'S	LBS.	PC. NO'S	COLOR	PC. NO'S	COLOR
1407	933	223866	194553	11#	7 Oz.	194548	Black	194549	Black
1407	932	223866	194553	11#	7 Oz.	194548	Black	194549	Black
1407	936	223866	194553	11#	7 Oz.	194548	Black	194549	Black
1407	937	223866	194553	11#	7 Oz.	194548	Black	194549	Black
1407	938	223866	194553	11#	7 Oz.	194548	Black	194549	Black
1407	939	230392	230470	8#	8 Oz.	194548	Black	194549	Black
1407	931	231031	194553	11#	7 Oz.	213807	Blue	213808	Blue
1407	921	231031	194553	11#	7 Oz.	213807	Blue	213808	Blue
1407	927	231031	194553	11#	7 Oz.	213807	Blue	213808	Blue
1407	L-294	230393	230390	7#	8 Oz.	194548	Black	194549	Black
1408	930	231031	194553	11#	7 Oz.	213807	Blue	213808	Blue
1408	934	228949	228960	8#		194548	Black	194549	Black
1408	935	228949	228960	8#		194548	Black	194549	Black
1408	973	231031	194553	11#	7 Oz.	213807	Blue	213808	Blue
1408	L-295	230391	230389	11#		213807	Blue	213808	Blue



Piece No.	Name	No. Required				
		905 906	1005 1006	1107 1108	1207 1208	1407 1408
<b>CLUTCH</b>						
143487	Clutch adjusting screw .....	3	-	-	-	-
143489	Lock plate .....	3	-	-	-	-
143488	Spring .....	3	-	-	-	-
202928	Clutch and brake pedal shaft .....	1	-	-	-	-
207748	Clutch and brake pedal shaft .....	-	1	1	-	-
221746	Clutch and brake pedal shaft .....	-	-	-	1	1
5506	Lockwasher 3/8" .....	1	-	-	-	-
7818	Screw 3/8-24 x 7/8" hex. hd. ....	1	-	-	-	-
5914	Washer plain special .....	1	-	-	-	-
207058	Clutch and brake pedal shaft dowel screw .....	-	1	1	-	-
221745	Clutch and brake pedal shaft dowel screw .....	-	-	-	1	1
5690	Gasket .....	-	1	1	1	1
202253	Clutch and brake pedal shaft lock ring .....	-	-	-	2	2
190912	Clutch and brake pedal shaft spring washer .....	1	-	-	-	-
221287	Clutch and brake pedal shaft spring washer .....	-	-	-	1	2
191048	Spring washer 15/16" .....	1	-	-	-	-
207041	Clutch and brake pedal shaft oil hole plug .....	-	1	1	1	1
203528	Clutch and brake pedal shaft oil hole restriction .....	-	1	1	1	1
190909	Clutch and brake pedal shaft support .....	1	-	-	-	-
207771	Clutch and brake pedal shaft support .....	-	1	1	1	1
7809	Screw 5/16-24 x 7/8" hex. hd. ....	-	3	3	2	2
6496	Screw 5/16-24 x 1-1/8" flat hd. ....	-	-	-	1	1
5504	Lockwasher 5/16" .....	-	3	3	3	3
7005	Nut 5/16-24 .....	-	3	3	3	3
3874	Washer 5/16" .....	-	3	3	3	3
190928	Clutch and brake pedal shaft washer-small .....	-	-	-	1	x
202199	Clutch and brake pedal shaft washer-small-thin .....	-	-	-	x	x
190961	Clutch and brake pedal shaft oil restriction .....	1	-	-	-	-
190904	Clutch and brake pedal shaft stop light switch housing .	1	-	-	-	-
7812	Clamp screw 5/16-24 x 1-3/4" hex. hd. ....	1	-	-	-	-
5504	Lockwasher 5/16" .....	1	-	-	-	-
7005	Nut 5/16-24 plain .....	1	-	-	-	-
202550	Clutch control vacuum tube dash connection .....	1	-	-	-	-
5843	Lockwasher 5/16" Shakeproof 165-S steel (Sherardize)	1	-	-	-	-
184335	Nut .....	1	-	-	-	-
183153	Washer .....	1	-	-	-	-
203178	Union .....	1	-	-	-	-
203177	Union nut .....	1	-	-	-	-
203187	Clutch control vacuum tube dash connection to intake manifold tube assembly .....	1	-	-	-	-
202572	Gasket .....	1	-	-	-	-
7004	Flange stud nut .....	3	-	-	-	-
5502	Lockwasher 1/4" .....	3	-	-	-	-
207235	Clutch control valve assembly (After Frame No. 900500) .	1	-	-	-	-
203929	Clutch control valve assembly (Prior to Frame No. 900501) (Repair parts not furnished, return defective assembly to factory) .....	1	-	-	-	-
6153	Screw 5/16-24 x 1-7/8" hex. hd. ....	1	-	-	-	-
6152	Screw 5/16-24 x 1-1/4" hex. hd. ....	1	-	-	-	-
5504	Lockwasher 5/16" .....	2	-	-	-	-
7705	Nut 5/16-24 .....	2	-	-	-	-
202872	Clutch control valve bracket .....	1	-	-	-	-
202892	Clutch control valve bracket cap .....	1	-	-	-	-
6315	Clutch control valve bracket cap stud .....	2	-	-	-	-
3874	Washer 5/16" .....	2	-	-	-	-
202917	Nut 5/16-24 blind .....	2	-	-	-	-
5504	Lockwasher 5/16" .....	2	-	-	-	-

## SERVICE PARTS LIST—PACKARD TWELVE

Clutch 23

Piece No.	Name	No. Required				
		905 906	1005 1006	1107 1108	1207 1208	1407 1408
202516	Clutch control valve to clutch vacuum cylinder tube front assembly .....	1	-	-	-	-
6259	Clutch control valve to clutch vacuum cylinder tube union .....	1	-	-	-	-
202300	Clutch control valve to clutch vacuum cylinder tube adapter .....	1	-	-	-	-
202901	Clutch control valve to clutch vacuum cylinder tube adapter screw .....	1	-	-	-	-
202310	Clutch control valve to clutch vacuum cylinder tube adapter screw gasket .....	2	-	-	-	-
202523	Clutch control valve to clutch vacuum cylinder vacuum release tube assembly (Used on 905 only) .....	1	-	-	-	-
202524	Clutch control valve to clutch vacuum cylinder vacuum release tube assembly (Used on 906 only) .....	1	-	-	-	-
5444	Union conn. 5/16" flared tube .....	1	-	-	-	-
5866	Union nut 5/16" flared tube .....	2	-	-	-	-
202536	Clutch control valve to clutch vacuum cylinder tube rear assembly (Used on 905 only) .....	1	-	-	-	-
202537	Clutch control valve to clutch vacuum cylinder tube rear assembly (Used on 906 only) .....	1	-	-	-	-
35579	Clutch control valve to clutch vacuum cylinder tube clip (Used on 906 only) .....	1	-	-	-	-
7710	Screw No. 10-32 x 5/8" fill. hd. (Used on 906 only) .	1	-	-	-	-
3866	Washer 3/16" (Used on 906 only) .....	1	-	-	-	-
5500	Lockwasher No. 10 (Used on 906 only) .....	1	-	-	-	-
7003	Nut No. 10-32 (Used on 906 only) .....	1	-	-	-	-
6263	Clutch control valve to clutch vacuum cylinder tube rear nut .....	1	-	-	-	-
202201	Clutch control valve to clutch vacuum cylinder tube hose.	1	-	-	-	-
202202	Clutch control valve to clutch vacuum cylinder tube hose clamp .....	1	-	-	-	-
203860	Clutch control valve to clutch vacuum cylinder tube hose clamp .....	1	-	-	-	-
202532	Clutch control valve to clutch vacuum cylinder tube hose clip .....	1	-	-	-	-
7710	Screw No. 10-32 x 5/8" fill. hd. .....	1	-	-	-	-
209851	Clutch control valve to clutch vacuum cylinder vacuum release tube clip .....	1	-	-	-	-
7824	Screw 1/4-28 x 5/8" hex. hd. .....	1	-	-	-	-
5502	Lockwasher 1/4" .....	1	-	-	-	-
7004	Nut 1/4-28 .....	1	-	-	-	-
167638	Clutch control valve to clutch vacuum cylinder vacuum release tube elbow 5/16" flared tube .....	1	-	-	-	-
202469	Clutch control valve connecting rod assembly (Prior to Steering Unit No. 210281) .....	1	-	-	-	-
210288	Clutch control valve connecting rod assembly (After Steering Unit No. 210280) .....	1	-	-	-	-
143143	Clutch control valve connecting rod ball joint .....	1	-	-	-	-
5500	Lockwasher No. 10 .....	1	-	-	-	-
7003	Nut No. 10-32 .....	2	-	-	-	-
4280	Cotter pin 1/16 x 1/2" .....	1	-	-	-	-
202290	Clutch control valve connecting rod end pin .....	1	-	-	-	-
202319	Clutch control valve connecting rod end pin spring washer	1	-	-	-	-
202296	Clutch control valve connecting rod eye .....	1	-	-	-	-
202470	Clutch control valve to dash connection tube hose .....	1	-	-	-	-
203860	Clutch control valve to dash connection hose clamp .....	2	-	-	-	-
202576	Clutch control valve to dash connection tube long asb. ..	1	-	-	-	-
202890	Clutch control valve flange and tube assembly .....	1	-	-	-	-
202318	Clutch control valve flange gasket .....	1	-	-	-	-
6149	Screw No. 10-24 x 5/8" hex. hd. .....	2	-	-	-	-

Piece No.	Name	No. Required				
		905 906	1005 1006	1107 1108	1207 1208	1407 1408
6154	Screw No. 10-24 x 1-3/16" hex. hd. ....	1	-	-	-	-
5500	Lockwasher No. 10 .....	3	-	-	-	-
183007	Clutch cover plate assembly .....	1	-	-	-	-
209520	Clutch cover plate assembly .....	-	1	1	-	-
221065	Clutch cover plate assembly .....	-	-	-	1	1
143483	Clutch cover plate .....	1	-	-	-	-
213387	Clutch cover plate .....	-	1	1	1	1
145258	Screw 3/8-24 x 7/8" hex. hd. special .....	3	12	12	12	-
7818	Screw 3/8-24 x 7/8" hex. hd. ....	-	-	-	12	12
5506	Lockwasher 3/8" .....	6	12	12	12	12
186855	Clutch cover plate dowel screw (Special pitch diameter) .	3	-	-	-	-
202605	Clutch cover plate spring cup .....	-	12	12	-	-
228514	Clutch cover plate spring cup .....	-	-	-	12	12
202607	Clutch cover plate spring cup rivet .....	-	12	12	-	-
228527	Clutch cover plate spring cup rivet .....	-	-	-	12	12
202612	Clutch driven plate facing .....	4	-	-	-	-
213372	Clutch driven plate facing .....	-	2	2	2	2
228618	Rivet .....	-	24	48	48	24
144765	Rivet .....	24	-	-	-	-
194745	Clutch driving plate .....	1	-	-	-	-
194853	Clutch driving plate and hub assembly .....	1	-	-	-	-
209518	Clutch driving plate and hub assembly .....	-	1	1	1	1
221872	Clutch operating auxiliary lever .....	-	-	-	1	1
219335	Clutch operating auxiliary lever bolt .....	-	-	-	1	1
7006	Nut 3/8-24 .....	-	-	-	1	1
5506	Lockwasher 3/8" .....	-	-	-	1	1
219336	Clutch operating auxiliary lever bushing (Supersedes 219339) .....	-	-	-	1	1
228740	Clutch operating auxiliary lever driving stud .....	-	-	-	1	1
302219	Clutch operating auxiliary lever retracting spring-long .	-	-	-	-	1
221869	Clutch operating auxiliary lever support inner and bushing assembly .....	-	-	-	1	1
221813	Clutch operating auxiliary lever support outer and bushing assembly .....	-	-	-	1	1
221253	Clutch operating auxiliary lever support bumper .....	-	-	-	1	1
219673	Clutch operating auxiliary lever support bumper bolt ....	-	-	-	1	1
7005	Nut 5/16-24 .....	-	-	-	1	1
219338	Clutch operating auxiliary lever support bushing .....	-	-	-	2	2
228741	Clutch operating lever (Supersedes 221815) .....	-	-	-	1	1
202245	Clutch operating lever bearing .....	-	-	-	1	1
202251	Clutch operating lever bearing dust washer .....	-	-	-	2	2
202254	Clutch operating lever bearing dust washer retainer-inner	-	-	-	2	2
202255	Clutch operating lever bearing dust washer retainer-outer	-	-	-	2	2
219671	Clutch operating lever retracting spring .....	-	-	-	1	1
228743	Clutch operating lever spring anchor assembly (Supersedes 223825) .....	-	-	-	1	1
223204	Clutch pedal assembly .....	-	-	-	1	1
202439	Clutch pedal .....	1	-	-	-	-
207751	Clutch pedal (Not used with clutch control) .....	-	1	1	-	-
210684	Clutch pedal (Used only with clutch control) .....	-	1	-	-	-
207745	Clutch pedal bearing (Not used with clutch control) .....	-	1	1	-	-
202245	Clutch pedal bearing (Used with clutch control for 1005-1006) .....	1	1	-	-	-
202251	Clutch pedal bearing dust washer .....	2	2	2	-	-
202254	Clutch pedal bearing dust washer retainer-inner .....	2	2	2	-	-
202255	Clutch pedal bearing dust washer retainer-outer .....	2	2	2	-	-
219949	Clutch pedal bushing .....	-	-	-	1	1

Piece No.	Name	No. Required				
		905 906	1005 1006	1107 1108	1207 1208	1407 1408
221260	Clutch pedal connecting rod assembly .....	-	-	-	1	1
202462	Clutch pedal connecting rod assembly .....	-	1	1	-	-
201504	Yoke end pin .....	-	1	1	-	-
7525	Yoke end pin .....	-	-	-	1	1
190291	Spring washer .....	-	2	2	2	2
4289	Cotter pin 3/32 x 1/2" .....	-	1	1	1	1
137960	Clutch pedal connecting rod adjusting nut (Prior to Frame No. 901177) .....	-	1	-	-	-
7405	Lock nut .....	-	2	2	2	2
138694	Clutch pedal connecting rod adjusting nut spring .....	-	1	1	1	1
210915	Clutch pedal connecting rod ball joint (After Frame No. 901176) .....	-	1	1	1	1
202456	Clutch pedal to clutch lever pin .....	1	-	-	-	-
4306	Cotter pin 1/8 x 1" .....	1	-	-	-	-
3916	Washer 5/16" special .....	1	-	-	-	-
202509	Clutch pedal lever assembly .....	1	-	-	-	-
210656	Clutch pedal lever assembly .....	-	1	-	-	-
190912	Spring washer .....	1	-	-	-	-
202832	Clutch pedal lever connecting rod assembly .....	1	-	-	-	-
190953	Yoke end pin .....	1	-	-	-	-
190291	Spring washer .....	1	-	-	-	-
4291	Cotter pin 3/32 x 3/4" .....	1	-	-	-	-
137960	Clutch pedal lever connecting rod adjusting nut .....	1	-	-	-	-
7405	Nut 5/16-24 .....	1	-	-	-	-
138694	Clutch pedal lever connecting rod adjusting nut spring .	1	-	-	-	-
202458	Clutch pedal lever retracting spring .....	1	-	-	-	-
210940	Clutch pedal lever retracting spring .....	-	1	-	-	-
191123	Clutch pedal lever retracting spring bracket .....	1	1	-	-	-
7826	Screw .....	2	-	-	-	-
5504	Lockwasher .....	2	-	-	-	-
7005	Nut .....	2	-	-	-	-
190928	Clutch pedal lever shim-thin .....	1	-	-	-	-
202248	Clutch pedal lever spacer .....	3	-	-	-	-
202267	Clutch pedal lever stop screw .....	1	1	-	-	-
7006	Nut 3/8-24 .....	1	1	-	-	-
202451	Clutch pedal lever stop screw bumper .....	1	-	-	-	-
202263	Clutch pedal lever stop screw bumper .....	-	1	-	-	-
202280	Screw special .....	-	1	-	-	-
210657	Screw special .....	-	1	-	-	-
5500	Lockwasher 3/16" std. ....	-	1	-	-	-
7003	Nut plain No. 10-32 .....	-	2	-	-	-
3866	Washer 3/16" plain .....	-	1	-	-	-
181401	Clutch pedal pad assembly .....	1	1	1	1	1
5504	Lockwasher 5/16" .....	1	1	1	1	1
7005	Nut 5/16-24 .....	1	1	1	1	1
8043	Screw 5/16-24 x 1-1/4" hex. hd. ....	1	1	1	1	1
177285	Clutch pedal pad assembly (Extension type) .....	1	-	-	-	-
163182	Clutch pedal pad tread .....	1	1	1	1	1
202253	Clutch pedal retaining ring .....	-	1	1	-	-
213469	Clutch pedal retracting spring (Not used with clutch control) .....	-	1	1	-	-
202355	Clutch pedal retracting spring .....	1	-	-	-	-
210940	Clutch pedal retracting spring (Used only with clutch control) .....	-	1	-	-	-
221283	Clutch pedal retracting spring .....	-	-	-	1	1
202475	Clutch pedal retracting spring pin .....	1	-	-	-	-
158459	Bolt .....	3	-	-	-	-
202248	Clutch pedal washer-thick .....	-	1	x	-	-
202247	Clutch pedal washer-thin .....	-	1	x	-	-

Piece No.	Name	No. Required				
		905 906	1003 1006	1107 1108	1207 1208	1407 1408
190912	Clutch pedal spring washer .....	-	1	1	-	-
202927	Clutch pedal spacer-inner .....	-	1	1	-	-
207754	Clutch pedal spacer-outer .....	-	1	1	-	-
191178	Clutch plate hub .....	-	1	1	1	1
210829	Clutch plate hub bolt .....	-	3	3	3	3
162957	Clutch plate hub bolt nut .....	-	3	3	3	3
163374	Clutch plate hub bolt nut .....	3	-	-	-	-
4280	Cotter pin 1/16 x 1/2" .....	3	3	3	3	3
158470	Washer .....	3	-	-	-	-
162627	Clutch plate hub clamp plate .....	-	1	1	1	1
158460	Clutch plate hub bolt spring .....	3	-	-	-	-
202613	Clutch plate hub bolt spring .....	-	3	3	-	-
228972	Clutch plate hub bolt spring .....	-	-	-	3	3
179843	Clutch plate hub friction plate .....	2	-	-	-	-
209754	Clutch plate hub friction plate .....	-	1	1	1	1
179578	Clutch plate hub spring .....	12	12	12	12	-
194746	Clutch pressure plate .....	1	-	-	-	-
230068	Clutch pressure plate (Supersedes 213376) .....	-	1	1	1	1
184346	Clutch pressure spring .....	12	-	-	-	-
213384	Clutch pressure spring-inner .....	-	12	12	12	12
213383	Clutch pressure spring-outer .....	-	12	12	-	-
221066	Clutch pressure spring-outer .....	-	-	-	12	12
202599	Clutch pressure spring insulator button .....	-	12	12	12	12
183012	Clutch pressure spring insulator button .....	12	-	-	-	-
183011	Clutch pressure spring locator .....	12	-	-	-	-
202610	Clutch pressure spring locator .....	-	12	12	12	-
179575	Clutch release lever .....	6	-	-	-	-
213374	Clutch release lever .....	-	6	6	-	-
225986	Clutch release lever .....	-	-	-	6	6
143476	Bolt .....	6	-	-	-	-
143478	Lock nut .....	6	-	-	-	-
213378	Clutch release lever pin-long .....	-	6	-	-	-
213379	Clutch release lever pin-short .....	-	6	-	-	-
213380	Clutch release lever adjusting yoke .....	-	6	6	-	-
225997	Clutch release lever adjusting yoke .....	-	-	-	6	6
213381	Clutch release lever adjusting yoke nut .....	-	6	6	6	6
213379	Clutch release lever adjusting yoke end pin-short .....	-	6	6	6	6
213378	Clutch release lever adjusting yoke end pin-long .....	-	6	6	6	6
4290	Cotter pin 3/32 x 5/8" .....	-	-	12	12	12
213382	Clutch release lever adjusting yoke end spring .....	-	6	6	-	-
228526	Clutch release lever adjusting yoke end spring .....	-	-	-	6	6
148024	Clutch release lever locking washer .....	6	-	-	-	-
186945	Clutch release lever reaction spring .....	6	-	-	-	-
213377	Clutch release lever roller .....	-	156	156	156	156
148025	Clutch release lever spring .....	6	-	-	-	-
144731	Washer .....	6	-	-	-	-
143480	Clutch separator spring .....	6	-	-	-	-
173541	Rivet .....	3	-	-	-	-
203497	Clutch vacuum cylinder assembly (Repair parts not furnished, return defective assembly to factory) .....	1	-	-	-	-
219668	Clutch vacuum cylinder assembly .....	-	-	-	1	1
7526	Clutch vacuum cylinder assembly yoke end pin 3/8" .....	-	-	-	1	1
4290	Cotter pin .....	-	-	-	1	1
190191	Spring washer 3/8" .....	-	-	-	2	2
203852	Clutch vacuum cylinder to bleeder valve tube assembly (Prior to Frame No. 900464) (Used on 905 only) .....	1	-	-	-	-
203854	Clutch vacuum cylinder to bleeder valve tube assembly (Prior to Frame No. 900464) (Used on 906 only) .....	1	-	-	-	-
205774	Clutch vacuum cylinder to bleeder valve tube assembly (Later frame No. 900463) (Used on 905 only) .....	1	-	-	-	-



Piece No.	Name	No. Required				
		905 906	1005 1006	1107 1108	1207 1208	1407 1408
205775	Clutch vacuum cylinder to bleeder valve tube assembly (After Frame No. 900463) (Used on 906 only) .....	1	-	-	-	-
143360	Clip .....	1	-	-	-	-
5871	Screw .....	1	-	-	-	-
7003	Nut No. 10-32 .....	1	-	-	-	-
5500	Lockwasher 3/16" .....	1	-	-	-	-
132447	Union nut 3/16" flared .....	2	-	-	-	-
202454	Clutch vacuum cylinder bracket .....	1	-	-	-	-
202452	Clutch vacuum cylinder bracket hook screw .....	2	-	-	-	-
7526	Yoke end pin 3/8" .....	1	-	-	-	-
190191	Yoke end pin spring washer .....	1	-	-	-	-
4280	Cotter pin 1/16 x 1/2" .....	1	-	-	-	-
5504	Lockwasher 5/16" .....	2	-	-	-	-
7005	Nut 5/16-24 .....	2	-	-	-	-
202455	Clutch vacuum cylinder connecting rod assembly (Used on 905 only) .....	1	-	-	-	-
202446	Clutch vacuum cylinder connecting rod assembly (Used on 906 only) .....	1	-	-	-	-
7525	Yoke end pin 5/16" .....	1	-	-	-	-
4289	Cotter pin 3/32 x 1/2" .....	1	-	-	-	-
190291	Spring washer .....	1	-	-	-	-
230062	Clutch vacuum cylinder connecting rod assembly (Supersedes 219667) .....	-	-	-	1	1
7006	Clutch vacuum cylinder connecting rod lock nut 3/8-24 ..	-	-	-	1	1
219863	Clutch vacuum cylinder connecting rod yoke end pin .....	-	-	-	1	1
4290	Cotter pin 3/32 x 5/8" .....	-	-	-	1	1
190291	Spring washer .....	-	-	-	1	1
7006	Clutch vacuum cylinder connecting rod end nut 3/8-24 ...	1	-	-	-	-
221850	Clutch vacuum cylinder support assembly .....	-	-	-	1	1
6039	Screw 5/16-24 x 11/16" hex. hd. ....	-	-	-	3	3
5504	Lockwasher 5/16" .....	-	-	-	3	3
7005	Nut 5/16-24 .....	-	-	-	3	3
219877	Clutch vacuum cylinder support washer .....	-	-	-	2	2
221545	Clutch vacuum dash connection .....	-	-	-	1	1
6482	Screw 5/16-24 x 3/4" hex. hd. ....	-	-	-	1	1
5504	Lockwasher 5/16" .....	-	-	-	1	1
223914	Clutch vacuum tank assembly .....	-	-	-	1	1
223917	Clutch vacuum tank bracket .....	-	-	-	4	4
7605	Bolt 5/16-24 x 5/8" carriage .....	-	-	-	4	-
7608	Bolt 5/16-24 x 3/4" carriage .....	-	-	-	-	4
5504	Lockwasher 5/16" .....	-	-	-	4	4
7005	Nut 5/16-24 .....	-	-	-	4	4
4155	Rivet 3/16 x 1/2" rnd. hd. ....	-	-	-	8	8
223123	Clutch vacuum tank drain connection .....	-	-	-	1	1
5421	Clutch vacuum tank drain plug 1/8" pipe hex. hd. ....	-	-	-	1	1
223942	Clutch vacuum tank elbow .....	-	-	-	1	1
225404	Clutch vacuum tank tube assembly .....	-	-	-	1	1
5465	Union nut 1/2" flared .....	-	-	-	2	2
225385	Clutch vacuum tank tube junction assembly .....	-	-	-	1	1
5469	Clutch vacuum tank tube junction screw 1/4-28 x 3/4" hex. hd. ....	-	-	-	2	2
7004	Nut 1/4-28 .....	-	-	-	2	2
5502	Lockwasher 1/4" .....	-	-	-	2	2
225479	Clutch vacuum tank tube junction to dash tube assembly .	-	-	-	1	1
173367	Clip (Style No. 18 x 1/2") .....	-	-	-	1	1
167261	Screw No. 10 x 3/8" Parker Kalon binding hd. ....	-	-	-	1	1
225410	Clutch vacuum tank tube junction plug .....	-	-	-	1	1
223683	Clutch vacuum valve assembly .....	-	-	-	1	1
215648	Clutch vacuum valve hose clamp assembly .....	-	-	-	4	4
225482	Clutch vacuum valve hose junction .....	-	-	-	1	1

Piece No.	Name	No. Required				
		903 906	1003 1006	1107 1108	1207 1208	1407 1408
230064	Clutch vacuum valve yoke end (adj) (Supersedes 219845) .	-	-	-	1	1
170074	Clutch vacuum valve yoke end nut .....	-	-	-	1	1
7525	Yoke end pin 5/16" .....	-	-	-	1	1
4290	Cotter pin 3/32 x 5/8" .....	-	-	-	1	1
190291	Spring washer 5/16" .....	-	-	-	1	1
3908	Washer 5/16" .....	-	-	-	1	1
225416	Clutch vacuum valve to vacuum cylinder hose .....	-	-	-	1	1
225417	Clutch vacuum valve to junction hose .....	-	-	-	1	1

## CLUTCH CONTROL

210951	Clutch and brake vacuum dash connection and vacuum control valve tube assembly .....	-	1	-	-	-
207235	Clutch control valve assembly (Repair parts not furnished, return defective assembly to factory) .....	-	1	-	-	-
6153	Bolt 5/16-24 x 1-7/8" hex. hd. ....	-	1	-	-	-
5504	Lockwasher 5/16" .....	-	2	-	-	-
6152	Screw 5/16-24 x 1-1/4" hex. hd. ....	-	1	-	-	-
7005	Nut 5/16-24 .....	-	2	-	-	-
202872	Clutch control valve bracket .....	-	1	-	-	-
202892	Clutch control valve bracket cap .....	-	2	-	-	-
6315	Clutch control valve bracket cap stud .....	-	2	-	-	-
3874	Washer 5/16" std. ....	-	2	-	-	-
5504	Lockwasher 5/16" std. ....	-	2	-	-	-
210877	Clutch control valve to clutch cushion control valve tube assembly .....	-	1	-	-	-
6278	Union nut 5/16 flared tube inverted (Weatherhead) ..	-	1	-	-	-
6258	Connector 5/16 flared tube (Weatherstrip) inverted .	-	1	-	-	-
5466	Union nut 5/16 flared tube .....	-	1	-	-	-
5405	Elbow 5/16 flared tube .....	-	1	-	-	-
210890	Clutch control valve to clutch vacuum cylinder tube front assembly .....	-	1	-	-	-
202901	Clutch control valve to clutch vacuum cylinder tube adapter screw .....	-	1	-	-	-
202310	Clutch control valve to clutch vacuum cylinder tube adapter screw gasket .....	-	2	-	-	-
202396	Clutch control valve to clutch vacuum cylinder tube rear assembly .....	-	1	-	-	-
6259	Clutch control valve to clutch vacuum cylinder tube rear union .....	-	1	-	-	-
6263	Clutch control valve to clutch vacuum cylinder tube rear nut 1/2 flared tube .....	-	1	-	-	-
213008	Clutch control valve to clutch vacuum cylinder tube hose .....	-	1	-	-	-
215648	Clutch control valve to clutch vacuum cylinder tube hose clamp assembly .....	-	2	-	-	-
202330	Clutch control valve to clutch vacuum cylinder tube hose clip .....	-	1	-	-	-
6154	Clutch control valve flange screw No. 10-24 x 1-3/16" hex. hd. ....	-	1	-	-	-
6149	Screw No. 10-24 x 1/2" hex. hd. ....	-	2	-	-	-
5500	Lockwasher No. 10 std. ....	-	3	-	-	-
202470	Clutch control valve flange to dash connection tube hose	-	1	-	-	-
215648	Clutch control valve flange to dash connection tube hose clamp assembly .....	-	2	-	-	-
210939	Clutch control valve flange and tube assembly .....	-	1	-	-	-
202318	Clutch control valve flange gasket .....	-	1	-	-	-
210119	Clutch control valve operating cable assembly .....	-	1	-	-	-
210676	Clutch control valve operating cable anchor spring .....	-	1	-	-	-

Piece No.	Name	No. Required				
		905 906	1005 1006	1107 1108	1207 1208	1407 1408
213136	Clutch control valve operating cable to dash clamp .....	-	1	-	-	-
201721	Screw No. 14 (.251) x 3/4" rnd. hd. Parker Kalon ...	-	2	-	-	-
5739	Screw No. 10-32 x 1/2" hex. hd. ....	-	2	-	-	-
213056	Clutch control valve operating cable clip .....	-	1	-	-	-
167261	Screw No. 10 (.187) x 3/8" Parker Kalon .....	-	1	-	-	-
190616	Clutch control valve operating cable knob .....	-	1	-	-	-
210959	Clutch control valve operating cable lever .....	-	1	-	-	-
210964	Clutch control valve operating cable lever bracket .....	-	1	-	-	-
7730	Screw No. 10-24 x 9/16" fill. hd. ....	-	2	-	-	-
5343	Screw No. 10-32 x 1/2" rnd. hd. ....	-	1	-	-	-
7003	Nut No. 10-32 std. ....	-	1	-	-	-
210962	Clutch control valve operating cable lever screw short .	-	1	-	-	-
190192	Spring washer 3/16" .....	-	1	-	-	-
5500	Lockwasher 3/16" std. ....	-	1	-	-	-
7003	Nut No. 10-32 std. ....	-	1	-	-	-
210936	Clutch control valve operating cable lever screw long ..	-	1	-	-	-
3866	Washer 3/16" plain std. ....	-	2	-	-	-
190192	Spring washer 3/16" .....	-	1	-	-	-
4280	Cotter pin 1/16" std. ....	-	1	-	-	-
5500	Lockwasher 3/16" std. ....	-	1	-	-	-
7003	Nut No. 10-32 std. ....	-	1	-	-	-
210965	Clutch control valve operating cable yoke end .....	-	1	-	-	-
213171	Clutch control valve operating cable yoke end pin .....	-	1	-	-	-
4280	Cotter pin 1/16" std. ....	-	1	-	-	-
3906	Washer 3/16" plain std. ....	-	2	-	-	-
210644	Clutch cushion control valve assembly (Repair parts not furnished, return defective assembly to factory) .....	-	1	-	-	-
210639	Clutch cushion control valve bracket .....	-	1	-	-	-
7827	Screw 1/4-28 x 5/8" hex. hd. ....	-	1	-	-	-
5502	Lockwasher 1/4" std. ....	-	1	-	-	-
7004	Nut 1/4-28 plain std. ....	-	1	-	-	-
5852	Clutch cushion control valve screw 1/4-28 x 1-7/8" hex. hd. ....	-	2	-	-	-
5502	Lockwasher 1/4" std. ....	-	2	-	-	-
7004	Nut 1/4-28 std. ....	-	2	-	-	-
210649	Clutch cushion control valve to vacuum cylinder tube assembly .....	-	1	-	-	-
5466	Union nut 5/16" flared tube .....	-	1	-	-	-
6278	Nut 5/16" flared tube inverted (Weatherhead) .....	-	1	-	-	-
6273	Elbow 5/16" flared tube (inverted) .....	-	1	-	-	-
203841	Clutch cushion control valve to vacuum cylinder tube tee	-	1	-	-	-
202261	Clutch vacuum cylinder assembly (Repair parts not furnished, return defective assembly to factory) .....	-	1	-	-	-
7526	Yoke end pin 3/8" .....	-	1	-	-	-
190191	Yoke end pin spring washer .....	-	1	-	-	-
4280	Cotter pin 1/16 x 1/2" .....	-	1	-	-	-
203842	Clutch vacuum cylinder to bleeder valve tube assembly ..	-	1	-	-	-
132447	Clutch vacuum cylinder to bleeder valve tube union nut .	-	2	-	-	-
202268	Clutch vacuum cylinder connecting rod assembly .....	-	1	-	-	-
7525	Yoke end pin 5/16" .....	-	1	-	-	-
4289	Cotter pin 3/32 x 1/2" .....	-	1	-	-	-
190291	Spring washer .....	-	1	-	-	-
7006	Nut 3/8-24 .....	-	1	-	-	-

Piece No.	Name	No. Required				
		905 906	1005 1006	1107 1108	1207 1208	1407 1408

**ELECTRICAL**

(See Wiring Diagram)

(905-906)

1.	191246	Electrical battery .....	1	-	-	-	-
2.	202393	Electrical horn-left .....	1	-	-	-	-
3.	202394	Electrical horn-right .....	1	-	-	-	-
4.	207013	Electrical steering gear lighting switch terminal block assembly (Supersedes 178009) .....	1	-	-	-	-
5.	190885	Electrical stop light switch .....	1	-	-	-	-
6.	202176	Electrical wiring fuse block assembly .....	1	-	-	-	-
7.	201223	Gasoline tank gauge assembly .....	1	-	-	-	-
8.	201208	Instrument board ammeter .....	1	-	-	-	-
9.	197488	Instrument board cigar lighter .....	1	-	-	-	-
10.	201195	Instrument board gasoline or oil gauge .....	1	-	-	-	-
11.	197492	Instrument board gasoline or oil gauge switch .....	1	-	-	-	-
12.	202908	Instrument board ignition coil and switch assembly .	1	-	-	-	-
13.	202898	Instrument board light socket and cable assembly indirect .....	1	-	-	-	-
14.	187295	Instrument board light direct (Reading light) .....	1	-	-	-	-
15.	197532	Instrument board light switch .....	1	-	-	-	-
16.	201511	Instrument board starter motor switch .....	1	-	-	-	-
17.	201119	Lamp front assembly .....	2	-	-	-	-
18.	202429	Lamp fender assembly .....	2	-	-	-	-
19.	186320	Lamp rear left .....	1	-	-	-	-
20.	186321	Lamp rear right .....	1	-	-	-	-
21.	194669	Lamp running board .....	2	-	-	-	-
22.	203016	Motor crankcase oil gauge and float assembly .....	1	-	-	-	-
23.	203013	Motor distributor .....	1	-	-	-	-
24.	98316	Motor generator (Supersedes 209074) .....	1	-	-	-	-
25.	207998	Motor ignition spark plug .....	12	-	-	-	-
26.	201234	Motor starter motor and switch assembly .....	1	-	-	-	-
27.	203780	Steering post horn button and contact assembly .....	1	-	-	-	-

**CABLES**

(See Wiring Diagram)

(905-906)

	CABLE	CABLE LENGTH	TERMINAL	INSULATORS
28.	Electrical-battery to ground cable assembly .	191167	.....	.....
29.	Electrical-battery frame junction to motor starter switch cable .....	157432	21"	127279 140076 184988
30.	Electrical-coil switch to gasoline and oil gauge cable .....	166404	13-1/2"	33287 36111
31.	Electrical-cigar lighter to fuse block cable .....	166400	25-1/2"	201710 36111
32.	Electrical-wiring left assembly (905) .....	202971	.....	.....
32.	Electrical-wiring left assembly (906) .....	202972	.....	.....
33.	Electrical-wiring right assembly .....	203126	.....	.....
34.	Electrical-wiring reading light to switch cable .....	166404	16"	.....
35.	Motor ignition coil to distributor high tension cable assembly .....	207477	42-1/2"	156625 156626
35.	Motor ignition coil to distributor high tension cable-right .....	207477	37"	156625 156626
36.	Motor ignition coil to distributor high tension cable-left .....	207477	35"	156625 156626
37.	Motor ignition coil to distributor low tension cable-left .....	166404	40"	33287 36111

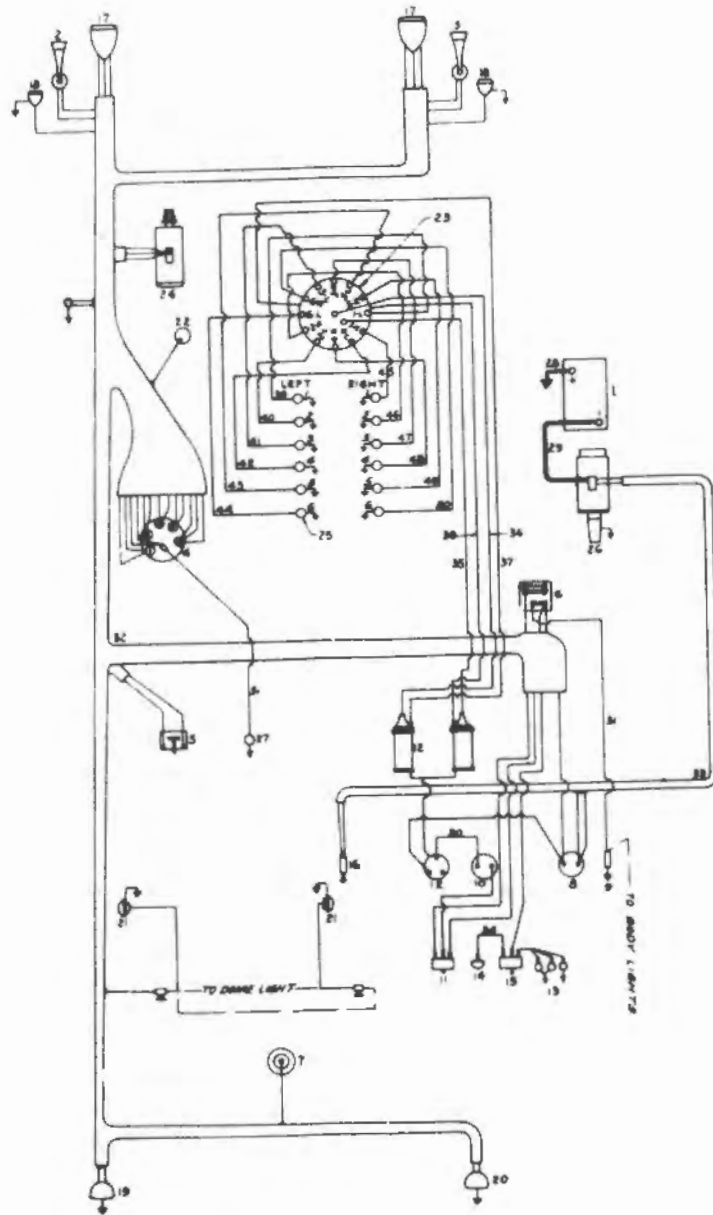

905-906



Piece No.	Name	CABLE	CABLE LENGTH	TERMINAL	INSULATORS
38.	Motor ignition coil to distributor low tension cable-right .....	166404	41-1/2"	33287	36111
39.	Motor ignition high tension cable to spark plug No. 1 left .....	207477	18"	156625	.....
40.	Motor ignition high tension cable to spark plug No. 2 left .....	207477	16-1/2"	156625	.....
41.	Motor ignition high tension cable to spark plug No. 3 left .....	207477	26"	156625	.....
42.	Motor ignition high tension cable to spark plug No. 4 left .....	207477	28-1/2"	156625	.....
43.	Motor ignition high tension cable to spark plug No. 5 left .....	207477	36"	156625	.....
44.	Motor ignition high tension cable to spark plug No. 6 left .....	207477	36"	156625	.....
45.	Motor ignition high tension cable to spark plug No. 1 right .....	207477	15"	156625	.....
46.	Motor ignition high tension cable to spark plug No. 2 right .....	207477	22"	156625	.....
47.	Motor ignition high tension cable to spark plug No. 3 right .....	207477	26-1/2"	156625	.....
48.	Motor ignition high tension cable to spark plug No. 4 right .....	207477	30-1/2"	156625	.....
49.	Motor ignition high tension cable to spark plug No. 5 right .....	207477	33-1/2"	156625	.....
50.	Motor ignition high tension cable to spark plug No. 6 right .....	207477	39"	156625	.....
51.	Steering post horn button to horn cable asb..	203797	.....	.....	.....

## ELECTRICAL

(See Wiring Diagram)

(1005-1006)

No. Required

		905	1005	1107	1207	1407
		906	1006	1108	1208	1408
1.	202175 Electrical-battery assembly .....	-	1	-	-	-
2.	209394 Electrical-horn left .....	-	1	-	-	-
2.	210469 Electrical-horn left-special paint .....	-	1	-	-	-
2.	210470 Electrical-horn right-special paint .....	-	1	-	-	-
2.	209395 Electrical-horn right .....	-	1	-	-	-
3.	209463 Electrical-steering gear lighting switch terminal block assembly .....	-	1	-	-	-
4.	209637 Electrical-stop light switch .....	-	1	-	-	-
5.	215591 Electrical-wiring fuse block assembly .....	-	1	-	-	-
6.	210260 Gasoline tank gauge assembly (Prior to Frame No. 901201) .....	-	1	-	-	-
6.	210299 Gasoline tank gauge assembly (After Frame No. 901200) .....	-	1	-	-	-
7.	209034 Instrument board ammeter (Prior to Frame No. 901201) .....	-	1	-	-	-
7.	210155 Instrument board ammeter (After Frame No. 901200) ..	-	1	-	-	-
8.	197488 Instrument board cigar lighter assembly .....	-	1	-	-	-
9.	210159 Instrument board gasoline or oil gauge (After Frame No. 901200) .....	-	1	-	-	-
9.	210272 Instrument gasoline or oil gauge (Prior to Frame No. 901201) .....	-	1	-	-	-
10.	197492 Instrument board gasoline or oil gauge switch .....	-	1	-	-	-
11.	209099 Instrument board ignition coil and switch assembly .	-	1	-	-	-
12.	126578 Instrument board light-direct (Reading light) .....	-	1	-	-	-
13.	202898 Instrument board light socket and cable assembly-indirect .....	-	1	-	-	-

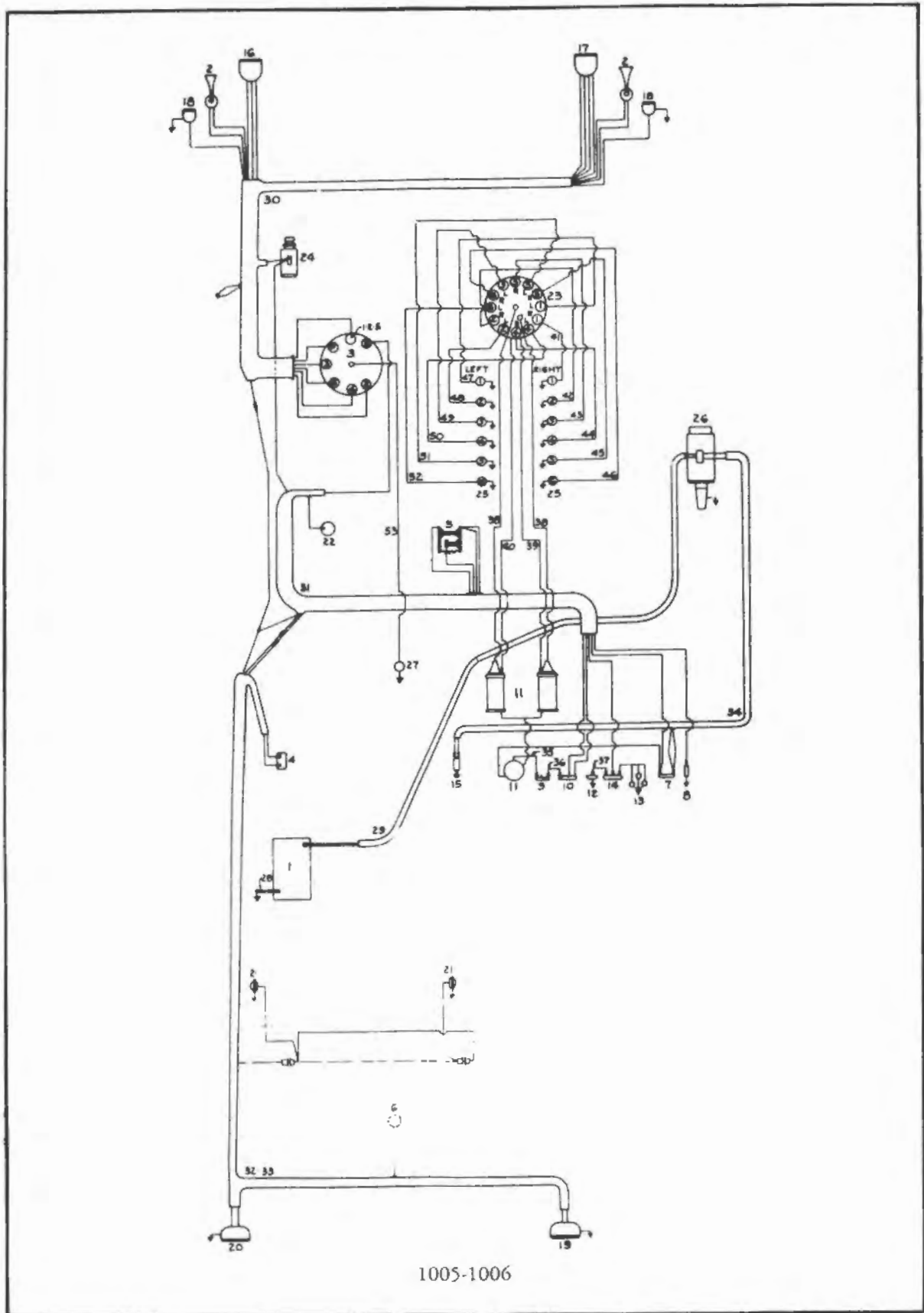

Piece No.	Name	No. Required				
		905 906	1005 1006	1107 1108	1207 1208	1407 1408
14.	197532 Instrument board light switch .....	-	1	-	-	-
15.	207800 Instrument board starter motor switch .....	-	1	-	-	-
16.	209038 Lamp front-assembly-left .....	-	1	-	-	-
17.	209039 Lamp front-assembly-right .....	-	1	-	-	-
18.	202429 Lamp fender-assembly .....	-	2	-	-	-
19.	209265 Lamp rear-right and bracket assembly .....	-	1	-	-	-
20.	209266 Lamp rear-left and bracket assembly .....	-	1	-	-	-
21.	194669 Lamp running board .....	-	2	-	-	-
22.	210298 Motor crankcase oil gauge and float assembly (After Frame No. 901200) .....	-	1	-	-	-
22.	203016 Motor crankcase oil gauge and float assembly (Prior to Frame No. 901201) .....	-	1	-	-	-
23.	207730 Motor distributor .....	-	1	-	-	-
24.	98316 Motor generator (Supersedes 209074) .....	-	1	-	-	-
25.	209704 Motor ignition spark plug .....	-	12	-	-	-
26.	210234 Motor starter motor and switch assembly .....	-	1	-	-	-
27.	203780 Steering post horn button and contact assembly .....	-	1	-	-	-

## CABLES

(See Wiring Diagram)

(1005-1006)

	CABLE	CABLE LENGTH	TERMINAL	INSULATORS
28.	Electrical-battery to ground cable assembly..	196972	.....	.....
29.	Electrical-battery to starter switch cable assembly .....	209109	.....	.....
30.	Electrical-wiring assembly-front left (Chassis) .....	209050	.....	.....
31.	Electrical-wiring assembly (Body) .....	209094	.....	.....
32.	Electrical-wiring assembly-rear left (Chassis) (1005) .....	209501	.....	.....
33.	Electrical-wiring assembly-rear left (Chassis) (1006) .....	209502	.....	.....
34.	Electrical-wiring assembly-right (Chassis) ..	209121	.....	.....
35.	Instrument board gasoline and oil gauge to coil switch cable .....	166404	13-1/2"	33287 36111
36.	Instrument board gasoline and oil gauge to switch cable .....	166404	7"	.....
37.	Instrument board reading light to switch cable .....	166404	16"	.....
38.	Motor ignition coil to distributor high tension cable .....	207477	44-1/2"	156625 156626
39.	Motor ignition coil to distributor low tension cable-right .....	166404	43-1/2"	33287 36111
40.	Motor ignition coil to distributor low tension cable-left .....	166404	42"	33287 36111
41.	Motor ignition high tension cable to spark plug No. 1 right .....	207477	14-5/8"	156625 156626
42.	Motor ignition high tension cable to spark plug No. 2 right .....	207477	19-1/8"	156625 156626
43.	Motor ignition high tension cable to spark plug No. 3 right .....	207477	22-1/2"	156625 156626
44.	Motor ignition high tension cable to spark plug No. 4 right .....	207477	27-1/4"	156625 156626
45.	Motor ignition high tension cable to spark plug No. 5 right .....	207477	30"	156625 156626
46.	Motor ignition high tension cable to spark plug No. 6 right .....	207477	38-1/4"	156625 156626
47.	Motor ignition high tension cable to spark plug No. 1 left .....	207477	17-3/4"	156625 156626

Piece No.	Name	CABLE	CABLE LENGTH	TERMINAL	INSULATORS
48.	Motor ignition high tension cable to spark plug No. 2 left .....	207477	13-5/8"	156625	.....
49.	Motor ignition high tension cable to spark plug No. 3 left .....	207477	22"	156625	.....
50.	Motor ignition high tension cable to spark plug No. 4 left .....	207477	24-3/8"	156625	.....
51.	Motor ignition high tension cable to spark plug No. 5 left .....	207477	32"	156625	.....
52.	Motor ignition high tension cable to spark plug No. 6 left .....	207477	33-3/4"	156625	.....
53.	Steering post horn button to horn cable .....	210886	.....	.....	.....

ELECTRICAL

(See Wiring Diagram)  
(1107-1108)

		No. Required				
		905 906	1005 1006	1107 1108	1207 1208	1407 1408
1.	202175 Electrical-battery assembly .....	-	-	1	-	-
2.	215851 Electrical-horn left .....	-	-	1	-	-
2.	215852 Electrical-horn left (Specify color) .....	-	-	1	-	-
2.	215853 Electrical-horn right .....	-	-	1	-	-
2.	215854 Electrical-horn right (Specify color) .....	-	-	1	-	-
3.	216134 Electrical-horn relay .....	-	-	1	-	-
4.	209463 Electrical-steering gear lighting switch terminal block assembly .....	-	-	1	-	-
5.	213805 Electrical-stop light switch .....	-	-	1	-	-
6.	215591 Electrical wiring fuse block assembly .....	-	-	1	-	-
7.	215016 Gasoline tank gauge assembly .....	-	-	1	-	-
8.	213832 Instrument board ammeter .....	-	-	1	-	-
9.	197488 Instrument board cigar lighter assembly .....	-	-	1	-	-
10.	213886 Instrument board gasoline or oil gauge .....	-	-	1	-	-
11.	197492 Instrument board gasoline or oil gauge switch .....	-	-	1	-	-
12.	215386 Instrument board ignition coil switch and bracket assembly .....	-	-	1	-	-
13.	215383 Instrument board ignition coil cable and switch asb. ....	-	-	1	-	-
14.	126578 Instrument board light-direct (Reading light) .....	-	-	1	-	-
15.	202888 Instrument board light socket and cable assembly indirect .....	-	-	1	-	-
16.	197532 Instrument board light switch .....	-	-	1	-	-
17.	207800 Instrument board starter motor switch .....	-	-	1	-	-
18.	209038 Lamp front assembly left .....	-	-	1	-	-
18.	209039 Lamp front assembly right .....	-	-	1	-	-
19.	202429 Lamp fender assembly .....	-	-	2	-	-
20.	215011 Lamp rear right and bracket assembly .....	-	-	1	-	-
20.	215010 Lamp rear left and bracket assembly .....	-	-	1	-	-
21.	215506 Lamp running board .....	-	-	2	-	-
22.	210298 Motor crankcase oil gauge and float assembly .....	-	-	1	-	-
23.	207730 Motor distributor .....	-	-	1	-	-
24.	219724 Motor generator (Supersedes 215265) .....	-	-	1	-	-
25.	209704 Motor ignition spark plug .....	-	-	12	-	-
26.	201234 Motor starter motor and switch assembly .....	-	-	1	-	-
27.	203780 Steering post horn button and contact assembly .....	-	-	1	-	-
28.	215371 Transmission back light switch .....	-	-	1	-	-
29.	215677 Electrical battery ground cable assembly .....	-	-	1	-	-
30.	209109 Electrical battery to starter switch cable assembly. ....	-	-	1	-	-
31.	215581 Electrical wiring assembly (1107) .....	-	-	1	-	-
31.	215580 Electrical wiring assembly (1108) .....	-	-	1	-	-

Piece No.	Name	No. Required					
		905 906	1005 1006	1107 1108	1207 1208	1407 1408	
32.	215850	Electrical wiring right assembly .....	-	-	1	-	-
33.	215515	Instrument board gasoline or oil gauge to switch cable assembly .....	-	-	1	-	-
34.	209858	Motor ignition coil to distributor high tension cable assembly .....	-	-	2	-	-
35.	209027	Motor ignition coil to distributor low tension cable assembly .....	-	-	2	-	-
36.	205141	Motor ignition high tension cable to spark plug No. 1 left assembly .....	-	-	1	-	-
37.	205142	Motor ignition high tension cable to spark plug No. 2 left assembly .....	-	-	1	-	-
38.	205143	Motor ignition high tension cable to spark plug No. 3 left assembly .....	-	-	1	-	-
39.	205144	Motor ignition high tension cable to spark plug No. 4 left assembly .....	-	-	1	-	-
40.	205145	Motor ignition high tension cable to spark plug No. 5 left assembly .....	-	-	1	-	-
41.	205146	Motor ignition high tension cable to spark plug No. 6 left assembly .....	-	-	1	-	-
42.	205147	Motor ignition high tension cable to spark plug No. 1 right assembly .....	-	-	1	-	-
43.	205148	Motor ignition high tension cable to spark plug No. 2 right assembly .....	-	-	1	-	-
44.	205149	Motor ignition high tension cable to spark plug No. 3 right assembly .....	-	-	1	-	-
45.	205150	Motor ignition high tension cable to spark plug No. 4 right assembly .....	-	-	1	-	-
46.	205151	Motor ignition high tension cable to spark plug No. 5 right assembly .....	-	-	1	-	-
47.	205152	Motor ignition high tension cable to spark plug No. 6 right assembly .....	-	-	1	-	-
48.	215050	Steering post horn button cable assembly .....	-	-	1	-	-

## ELECTRICAL

(See Wiring Diagram)

1.	202175	Electrical battery assembly .....	-	-	-	1	-
1.	230345	Electrical battery assembly .....	-	-	-	-	1
2.	225162	Electrical horn-left .....	-	-	-	1	1
3.	225163	Electrical horn-right .....	-	-	-	1	1
4.	303796	Electrical horn relay (Supersedes 216134) .....	-	-	-	1	1
5.	213805	Electrical stop light switch .....	-	-	-	1	1
6.	223759	Electrical wiring fuse block assembly .....	-	-	-	1	1
7.	225647	Electrical wiring-steering gear lighting switch terminal block assembly .....	-	-	-	1	1
8.	223826	Gasoline tank gauge assembly (Used with L194-L195- 832-33-34-35-30-31-21-932-33-34-35-21-31-30-L294- L295) .....	-	-	-	1	1
8.	225619	Gasoline tank gauge assembly (Used with 836-37-38- 39-27-73-936-37-38-39-27-73) .....	-	-	-	1	1
9.	228505	Instrument board ammeter .....	-	-	-	1	1
10.	197488	Instrument board cigar lighter assembly .....	-	-	-	1	I
11.	223921	Instrument board clock .....	-	-	-	1	1
12.	228503	Instrument board gasoline gauge .....	-	-	-	1	-
12.	230104	Instrument board gasoline gauge .....	-	-	-	-	1
13.	223784	Instrument board gasoline gauge or oil gauge switch. .....	-	-	-	1	-
14.	225601	Instrument board light cable and socket assembly ...	-	-	-	1	1
15.	223922	Instrument board panel light switch assembly .....	-	-	-	1	1
16.	225151	Instrument board reading light socket assembly .....	-	-	-	1	1
17.	182459	Instrument board reading light switch .....	-	-	-	1	1

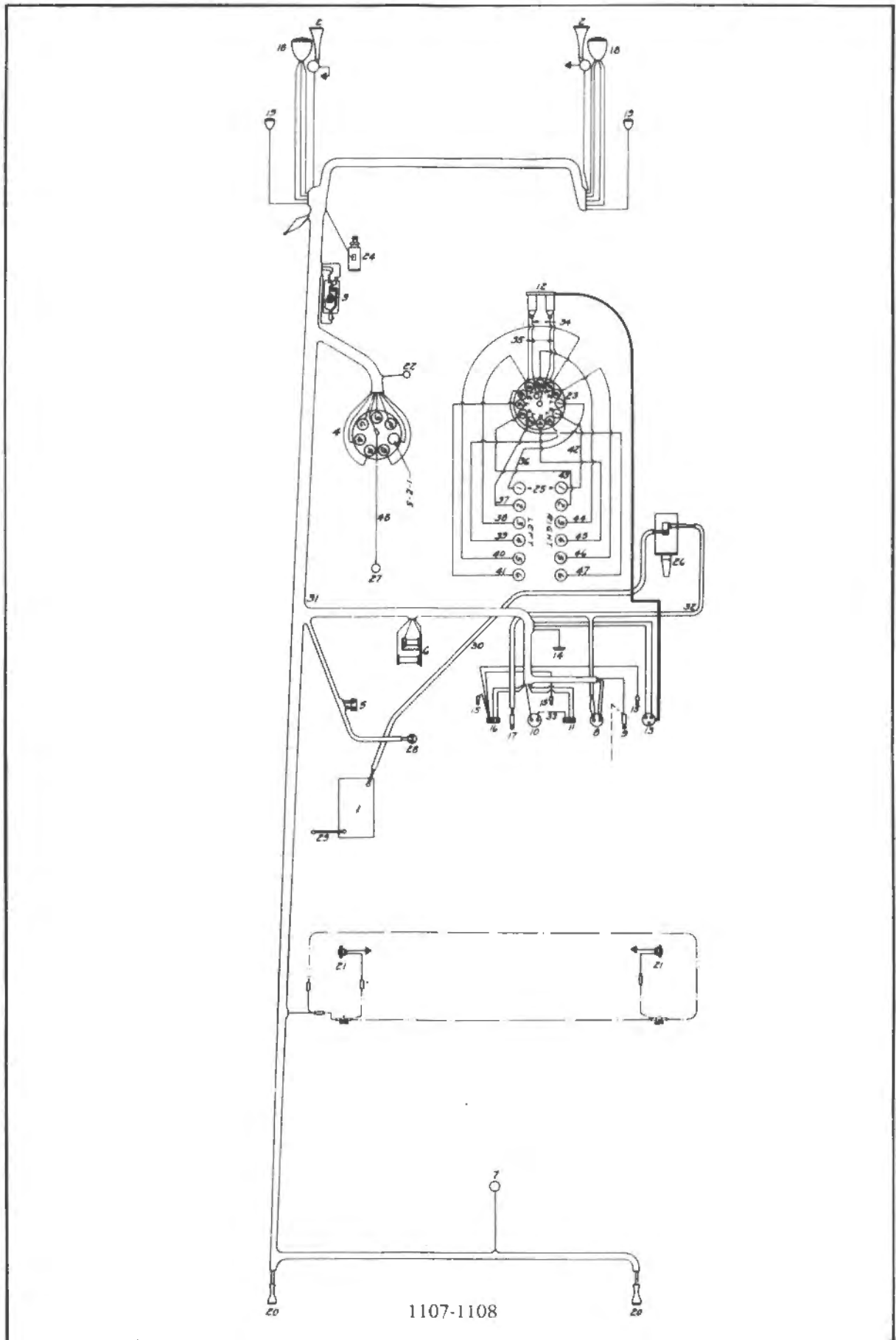



Piece No.	Name	No. Required					
		903 906	1005 1006	1107 1108	1207 1208	1407 1408	
18.	223889	Instrument board lightbulb signal .....	-	-	-	4	4
19.	207800	Instrument board starter motor switch .....	-	-	-	1	1
20.	218823	Lamp courtesy assembly .....	-	-	-	2	2
21.	225969	Lamp front assembly-right .....	-	-	-	1	1
21.	225970	Lamp front assembly-left .....	-	-	-	1	1
22.	225689	Lamp fender assembly .....	-	-	-	2	2
23.	223313	Lamp rear right assembly .....	-	-	-	1	1
23.	223312	Lamp rear left assembly .....	-	-	-	1	1
24.	223919	Motor crankcase oil gauge and float assembly .....	-	-	-	1	-
25.	221011	Motor distributor .....	-	-	-	1	-
25.	230311	Motor distributor .....	-	-	-	-	1
26.	223499	Motor generator .....	-	-	-	1	-
26.	230430	Motor generator .....	-	-	-	-	1
27.	215384	Motor ignition coil .....	-	-	-	1	1
28.	209704	Motor ignition spark plug .....	-	-	-	12	12
29.	223659	Motor ignition switch and cable assembly .....	-	-	-	1	1
30.	223127	Motor starter motor and switch assembly .....	-	-	-	1	1
31.	203780	Steering post horn button and contact assembly .....	-	-	-	1	1
32.	215371	Transmission backing light switch .....	-	-	-	1	1
33.	223924	Electrical battery to ground cable assembly .....	-	-	-	1	1
34.	230077	Electrical battery to starter switch cable assembly (Use with bodies 821-31-36-38-39-921-31-36-38-39) .....	-	-	-	1	1
34.	230078	Electrical battery to starter switch cable assembly (Use with bodies 827-32-33-37-73-927-32-33-37-73- L195-L294) .....	-	-	-	1	1
34.	230079	Electrical battery to starter switch cable assembly (Use on bodies 830-34-35-L194-930-34-35-L295) .....	-	-	-	1	1
35.	225396	Electrical gasoline and oil gauge to switch cable assembly .....	-	-	-	1	-
36.	197983	Electrical motor to frame ground cable assembly .....	-	-	-	1	1
37.	225307	Electrical wiring left assembly (Used on 1207) .....	-	-	-	1	-
37.	230097	Electrical wiring left assembly (Used on 1407) .....	-	-	-	-	1
37.	225308	Electrical wiring left assembly (Used on 1208) .....	-	-	-	1	-
37.	230098	Electrical wiring left assembly (Used on 1408) .....	-	-	-	-	1
38.	225309	Electrical wiring right assembly .....	-	-	-	1	-
38.	230073	Electrical wiring right assembly .....	-	-	-	-	1
39.	225386	Electrical wiring horn cable assembly-left .....	-	-	-	1	1
40.	225387	Electrical wiring horn cable assembly-right .....	-	-	-	1	1
41.	225151	Instrument board reading light socket and cable asb.	-	-	-	1	1
42.	225756	Lamp fender extension cable assembly .....	-	-	-	2	2
43.	209858	Motor ignition coil to distributor high tension cable assembly .....	-	-	-	2	2
44.	228929	Motor ignition spark plug cable assembly-left No. 1.	-	-	-	1	1
44.	228930	Motor ignition spark plug cable assembly-left No. 2.	-	-	-	1	1
44.	228932	Motor ignition spark plug cable assembly-left No. 3.	-	-	-	1	1
44.	228933	Motor ignition spark plug cable assembly-left No. 4.	-	-	-	1	1
44.	228935	Motor ignition spark plug cable assembly-left No. 5.	-	-	-	1	1
44.	228936	Motor ignition spark plug cable assembly-left No. 6.	-	-	-	1	1
44.	228929	Motor ignition spark plug cable assembly-right No. 1	-	-	-	1	1
44.	228931	Motor ignition spark plug cable assembly-right No. 2	-	-	-	1	1
44.	228933	Motor ignition spark plug cable assembly-right No. 3	-	-	-	1	1
44.	228934	Motor ignition spark plug cable assembly-right No. 4	-	-	-	1	1
44.	228935	Motor ignition spark plug cable assembly-right No. 5	-	-	-	1	1
44.	228937	Motor ignition spark plug cable assembly-right No. 6	-	-	-	1	1
45.	225279	Steering post horn button cable assembly .....	-	-	-	1	1

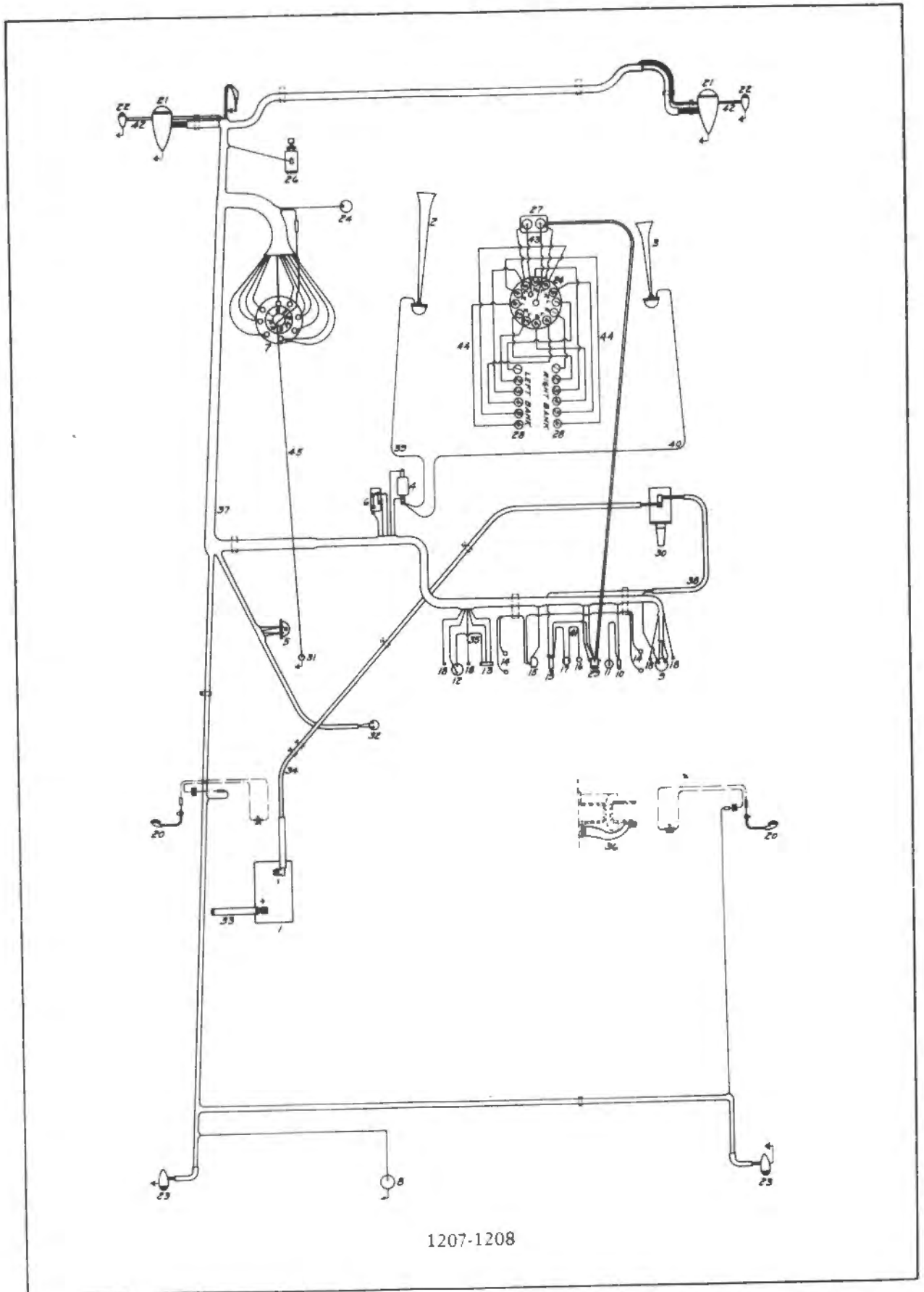

1207-1208

Piece No.	Name	No. Required				
		905 906	1003 1006	1107 1108	1207 1208	1407 1408
<b>ELECTRICAL (Miscellaneous)</b>						
202175	Electrical battery assembly .....	-	1	1	1	-
230345	Electrical battery assembly .....	-	-	-	-	1
191246	Electrical battery assembly (Prest-O-Lite type AH 6175- G-special No. 1205) .....	1	-	-	-	-
191168	Electrical battery to frame junction cable .....	1	-	-	-	-
191647	Terminal (Negative) .....	1	-	-	-	-
140076	Terminal 1/2 I.D. x 13/32" eye .....	1	-	-	-	-
7406	Nut 3/8-24 .....	1	-	-	-	-
5506	Lockwasher 3/8" .....	1	-	-	-	-
197991	Electrical battery to frame junction cable insulator ...	1	-	-	-	-
191167	Electrical battery to ground cable assembly .....	1	-	-	-	-
196972	Electrical battery to ground cable assembly .....	-	1	-	-	-
215677	Electrical battery to ground cable assembly .....	-	-	1	-	-
223924	Electrical battery to ground cable assembly .....	-	-	-	1	1
3877	Washer 3/8" plain .....	1	1	1	1	1
5958	Screw 3/8-24 x 1-3/16" hex. hd. ....	-	1	1	1	1
5506	Lockwasher 3/8" .....	-	1	1	1	1
7006	Nut 3/8-24 plain std. ....	-	1	1	1	1
7406	Nut 3/8-24 plain .....	1	-	-	-	-
190124	Electrical battery frame junction cable terminal stud (Negative) .....	1	-	-	-	-
7406	Nut 3/8-24 plain .....	2	-	-	-	-
5506	Lockwasher 3/8" .....	2	-	-	-	-
190120	Insulator-inner .....	1	-	-	-	-
190119	Insulator-outer .....	1	-	-	-	-
126770	Insulator-retaining washer .....	1	-	-	-	-
190122	Insulator-tube .....	1	-	-	-	-
190121	Electrical battery frame junction cable terminal stud (Positive) .....	1	-	-	-	-
5506	Lockwasher 3/8" .....	1	-	-	-	-
7406	Nut 3/8-24 plain .....	1	-	-	-	-
126770	Washer 3/8" special .....	1	-	-	-	-
203156	Electrical battery frame junction to motor starter switch cable assembly .....	1	-	-	-	-
184988	Insulator .....	2	-	-	-	-
127279	Terminal 1/2 I.D. x 12/32" eye .....	1	-	-	-	-
140076	Terminal 1/2 I.D. x 13/32" eye .....	1	-	-	-	-
197877	Cable clip style No. 18 x 5/8" .....	1	-	-	-	-
201455	Electrical battery retaining clamp .....	-	1	-	-	-
215351	Electrical battery retaining clamp .....	-	-	2	2	2
215352	Electrical battery retaining clamp screw (2-3/16" long).	-	-	2	2	-
223117	Electrical battery retaining clamp screw (2-11/16" long)	-	-	-	2	2
215353	Electrical battery retaining clamp nut .....	-	-	2	2	2
5506	Lockwasher 3/8" .....	-	2	-	-	-
209109	Electrical battery to starter switch cable assembly ....	-	1	1	-	-
230077	Electrical battery to starter switch cable assembly (Used with bodies 836-838-9-831-939-36-38-921-31) ....	-	-	-	1	1
230078	Electrical battery to starter switch cable assembly (Used with bodies 832-33-37-21-27-873-L195-932-33-37- 27-73-L294) .....	-	-	-	1	1
230079	Electrical battery to starter switch cable assembly (Used on model 1208) (Used with bodies 830-34-35-L194- 930-34-35-L295) .....	-	-	-	1	1
194151	Clip Style No. 1 x 5/8" .....	-	-	-	2	2
201570	Clip .....	-	-	-	2	2
209163	Clip .....	-	2	2	-	-
7824	Screw 1/4-28 x 5/8" hex. hd. ....	-	2	2	-	-
5502	Lockwasher 1/4" .....	-	2	2	-	-

Piece No.	Name	No. Required				
		905 906	1005 1006	1107 1108	1207 1208	1407 1408
7004	Nut 1/4-28 .....	-	2	2	-	-
7710	Electrical battery to starter switch cable clip screw No. 10-32 x 5/8" fill. hd. ....	-	-	-	3	3
7003	Nut No. 10-32 .....	-	-	-	3	3
5500	Lockwasher 5/16" .....	-	-	-	3	3
3867	Washer 3/16 x 5/8" .....	-	-	-	1	1
216945	Electrical battery terminal grease retainer .....	-	-	2	2	2
210833	Electrical battery to starter switch cable insulator ...	-	1	1	-	-
225395	Electrical battery to starter switch cable insulator ...	-	-	-	1	1
225514	Electrical battery to starter switch cable insulator ...	-	-	-	1	1
209110	Electrical battery to starter switch cable insulator (Used on model 1208) .....	-	-	-	1	1
191647	Terminal (Battery end negative) .....	-	1	1	1	1
140076	Terminal (Switch end) .....	-	1	1	1	1
223839	Electrical battery support front assembly (Used with bodies 836-38-39-821-31-921-31-38-36-39) .....	-	-	-	1	1
223881	Electrical battery support front assembly (Used with bodies 832-33-37-27-L195-932-3-7-27-L294) .....	-	-	-	1	1
223882	Electrical battery support front assembly (Used with bodies 830-34-35-L194-930-34-35-L295) .....	-	-	-	1	1
228828	Electrical battery support front assembly (Use with body 873-973) .....	-	-	-	1	1
223886	Electrical battery support rear assembly (Used with bodies 836-838-839-873-21-31-936-38-39-73-21-31) .....	-	-	-	1	1
223887	Electrical battery support rear assembly (Used with bodies 832-3-4-37-27-30-35-L194-L195-927-30-32-33-34- 35-37-L294-L295) .....	-	-	-	1	1
201455	Electrical battery support bottom .....	-	-	-	1	1
215795	Electrical battery support bottom spacer .....	-	-	-	2	2
210454	Electrical battery support bottom screw 3/8-24 x 1-1/4" hex. hd. ....	-	-	-	2	2
5506	Lockwasher 3/8" .....	-	-	-	2	2
201172	Electrical battery support clamping bolt .....	-	2	2	1	1
6090	Bolt 3/8-24 x 1-1/16" hex. hd. ....	-	2	-	-	-
7004	Nut 1/4-28 .....	-	4	4	2	2
7872	Electrical battery support front to frame X-member screw 3/8-24 x 3/4" hex. hd. ....	-	-	-	3	3
5506	Lockwasher 3/8" .....	-	-	-	3	3
7006	Nut 3/8-24 .....	-	-	-	3	3
7872	Electrical battery support rear to frame screw 3/8-24 x 3/4" hex. hd. ....	-	-	-	3	3
5506	Lockwasher 3/8" .....	-	-	-	3	3
7006	Nut 3/8-24 .....	-	-	-	3	2
7006	Electrical battery support screw nut 3/8-24 .....	-	-	-	2	2
7826	Electrical battery support rear to side plate screw 5/16-24 x 5/8" hex. hd. ....	-	-	-	2	2
5504	Lockwasher 5/16" .....	-	-	-	2	2
7005	Nut 5/16-24 .....	-	-	-	2	2
201737	Electrical cable connector tip (Female) .....	4	13	7	5	5
201736	Electrical cable connector tip (Male) .....	4	9	9	10	10
53127	Electrical cable terminal side 25/64" eye .....	1	1	1	1	1
33287	Electrical cable terminal 13/64" eye .....	16	18	18	18	16
194186	Electrical cable terminal 21/64" eye .....	1	-	-	-	-
169549	Electrical cable terminal 21/64" eye (Double cable) ....	1	-	-	-	-
144785	Electrical cable terminal 7/32" eye .....	1	1	-	-	-
216204	Electrical cable terminal 7/32" eye .....	-	-	1	1	1
215507	Electrical cable terminal 11/64" eye .....	-	-	2	-	-
166872	Electrical cable terminal 7/32" eye .....	2	3	4	1	1
71397	Electrical cable terminal 11/64" eye open end .....	5	6	7	-	-

Piece No.	Name	No. Required				
		905 906	1005 1006	1107 1108	1207 1208	1407 1408
201710	Electrical cable terminal 11/64" open end .....	2	3	2	9	9
48202	Electrical cable terminal 1/4" eye .....	2	2	1	1	1
148994	Electrical cable terminal special .....	2	-	-	-	-
36111	Electrical cable terminal insulator .....	16	28	29	39	36
225376	Electrical cable terminal 11/64" eye open end .....	-	-	-	12	9
225377	Electrical cable terminal 11/64" eye .....	-	-	-	1	2
48616	Electrical cable terminal insulator .....	9	5	6	3	3
148996	Electrical cable terminal insulator .....	2	-	-	-	-
202926	Electrical cable terminal insulator .....	4	9	13	9	9
203901	Electrical cable terminal insulator .....	-	1	1	1	1
202393	Electrical horn-left .....	1	-	-	-	-
202394	Electrical horn-right .....	1	-	-	-	-
209394	Electrical horn-left (Return defective unit to the factory for repairs or adjustment) .....	-	1	-	-	-
210469	Electrical horn-left (Specify color) (Return defective unit to the factory for repairs or adjustment) .....	-	1	-	-	-
209395	Electrical horn-right (Return defective unit to the factory for repairs or adjustment) .....	-	1	-	-	-
210470	Electrical horn-right (Specify color) (Return defective unit to the factory for repairs or adjustment) .....	-	1	-	-	-
215851	Electrical horn-left (Return defective unit to the factory for repairs or adjustment) .....	-	-	1	-	-
215852	Electrical horn-left (Specify color) (Return defective unit to the factory for repairs or adjustment) .....	-	-	1	-	-
215853	Electrical horn-right (Return defective unit to the factory for repairs or adjustment) .....	-	-	1	-	-
215854	Electrical horn-right (Specify color) (Return defective unit to the factory for repairs or adjustment) .....	-	-	1	-	-
225162	Electrical horn-left (Sparton) .....	-	-	-	1	1
225163	Electrical horn-right (Sparton) .....	-	-	-	1	1
6114	Electrical horn to bracket stud .....	-	4	4	-	-
7004	Nut 1/4-28 plain .....	-	4	-	-	-
6164	Nut 1/4-28 blind .....	-	4	4	-	-
5502	Lockwasher 1/4" .....	-	4	4	-	-
209694	Electrical horn bumper assembly .....	-	2	2	-	-
139489	Rivet 9/64 x 3/16" flat hd. ....	-	6	6	-	-
196792	Electrical horn cable insulation .....	2	2	2	-	-
225381	Electrical horn grommet .....	-	-	-	2	2
194643	Electrical horn to horn button cable connector (Single).	1	1	-	-	-
6147	Electrical horn to radiator shell brace screw 1/4-28 x 1" hex. hd. ....	4	-	-	-	-
5502	Lockwasher 1/4" .....	4	-	-	-	-
7004	Nut 1/4-28 plain .....	4	-	-	-	-
303796	Electrical horn relay (Supersedes 216134) .....	-	-	1	1	1
5815	Screw No. 10-32 x 7/8" fill. hd. ....	-	-	1	-	-
145661	Screw No. 10-32 x 5/16" hex. hd. ....	-	-	-	2	2
3867	Washer .....	-	-	1	-	-
3866	Washer .....	-	-	1	2	2
5500	Lockwasher 3/16" .....	-	-	1	2	2
5502	Lockwasher 1/4" .....	-	-	1	-	-
7004	Nut 1/4-28 .....	-	-	1	-	-
7003	Nut No. 10-32 .....	-	-	1	-	2
216143	Electrical horn relay screw spacer .....	-	-	1	-	-
5870	Electrical horn relay terminal screw-long (No. 10-32 x 1/2" rnd. hd.) .....	-	-	1	1	1
5676	Electrical horn relay terminal screw-short (No. 10-32 x 3/8" rnd. hd.) .....	-	-	1	1	1
3866	Washer No. 10 .....	-	-	2	2	2
5500	Lockwasher 3/16" .....	-	-	2	2	2

Piece No.	Name	No. Required				
		905 906	1005 1006	1107 1108	1207 1208	1407 1408
133147	Nut No. 10-32 special .....	-	-	2	-	-
7003	Nut No. 10-32 .....	-	-	-	2	2
225520	Electrical horn support bracket nut No.10-24 .....	-	-	-	4	4
4683	Electrical horn support bracket lockwasher .....	-	-	-	4	4
5310	Electrical horn terminal screw No. 8-32 x 1/4" rnd. hd..	-	-	-	2	2
3774	Lockwasher .....	-	-	-	2	2
225262	Electrical instrument board signal light contact asb. ..	-	-	-	4	4
225261	Electrical instrument board signal light socket .....	-	-	-	4	4
225263	Electrical instrument board signal light spring .....	-	-	-	4	4
225264	Electrical instrument board signal light spring washer .	-	-	-	4	4
148974	Electrical lamp front cable connecting plug assembly ...	2	-	-	-	-
148996	Electrical lamp front cable connecting plug ground wire terminal insulator .....	2	-	-	-	-
170913	Electrical lamp front cable connecting plug to headlight sleeve .....	2	-	-	-	-
5471	Electrical lamp front ground wire to frame screw 1/4-28 x 3/4" hex. hd. std. ....	1	-	-	-	-
7004	Nut 1/4-28 plain .....	1	-	-	-	-
3874	Washer 5/16" .....	2	-	-	-	-
5502	Lockwasher 1/4" .....	1	-	-	-	-
5471	Electrical lamp front ground wire to frame screw .....	-	1	-	-	-
5502	Lockwasher 1/4" .....	-	1	-	-	-
7004	Nut .....	-	1	-	-	-
3874	Washer .....	-	2	-	-	-
210862	Electrical lamp rear cable conduit assembly .....	-	2	-	-	-
127039	Electrical lamp rear connecting plug rear .....	2	-	-	-	-
194314	Electrical lamp rear connecting plug sleeve .....	2	-	-	-	-
197983	Electrical motor to frame ground cable assembly .....	1	1	1	1	1
3877	Washer 3/8" plain (2P No. 1407) .....	2	2	2	2	2
167660	Electrical motor starter switch and ammeter cable insulator .....	1	-	-	-	-
207013	Electrical steering gear lighting switch assembly (Supersedes 178009) .....	1	-	-	-	-
209463	Electrical steering gear lighting switch terminal block assembly .....	-	1	1	-	-
145661	Electrical steering gear lighting switch adjusting screw	1	-	-	-	-
5500	Lockwasher .....	1	-	-	-	-
184329	Electrical steering gear lighting switch cover .....	1	-	-	-	-
209461	Electrical steering gear lighting switch cover .....	-	1	-	1	1
216100	Electrical steering gear lighting switch cover .....	-	-	1	-	-
145661	Electrical steering gear lighting switch cover screw ...	1	-	-	-	-
5500	Lockwasher No.10 .....	1	-	-	-	-
194977	Electrical steering gear lighting switch cover cable bushing .....	1	-	-	-	-
302121	Electrical stop light fuse (20 amp.) .....	-	-	-	1	1
228888	Electrical stop light fuse container and cable assembly.	-	-	-	1	1
228827	Electrical stop light fuse container cap .....	-	-	-	1	1
190885	Electrical stop light switch .....	1	-	-	-	-
213805	Electrical stop light switch .....	-	1	1	1	1
7870	Screw 1/4-28 x 5/8" hex. hd. ....	-	2	2	2	2
5502	Lockwasher 1/4" .....	-	2	2	2	2
5198	Screw No. 10-32 x 5/8" hex. hd. ....	2	-	-	-	-
7004	Nut 1/4-28 .....	-	2	2	2	2
5500	Lockwasher No. 10 .....	2	-	-	-	-
3868	Washer .....	-	2	2	2	2
183068	Electrical stop light switch cable bushing .....	2	-	-	-	-
215581	Electrical wiring assembly (Used on 1107) .....	-	-	1	-	-
215580	Electrical wiring assembly (Used on 1108) .....	-	-	1	-	-
225307	Electrical wiring left assembly (Used on 1207) .....	-	-	-	1	-
225308	Electrical wiring left assembly (Used on 1208) .....	-	-	-	1	-



Piece No.	Name	No. Required				
		905 906	1005 1006	1107 1108	1207 1208	1407 1408
230073	Electrical wiring right assembly (Supersedes 225309) ...	-	-	-	-	-
202971	Electrical wiring left assembly (Used on 905 only) .....	1	-	-	-	-
202972	Electrical wiring left assembly (Used on 906 only) .....	1	-	-	-	-
203126	Electrical wiring right assembly .....	1	-	-	-	-
209094	Electrical wiring assembly (Body) .....	-	1	-	-	-
209050	Electrical wiring front left assembly (Chassis) .....	-	1	-	-	-
209121	Electrical wiring right assembly (Chassis) .....	-	1	-	-	-
215850	Electrical wiring right assembly .....	-	-	1	-	-
209502	Electrical wiring rear left assembly (Chassis) (Used on 1006 only) .....	-	1	-	-	-
209501	Electrical wiring rear left assembly (Chassis) (Used on 1005 only) .....	-	1	-	-	-
213014	Electrical wiring battery insulator .....	-	-	1	-	-
144926	Electrical wiring battery to starter switch cable retaining ring .....	-	-	1	1	1
129773	Electrical wiring backing light switch cable clip .....	-	-	1	1	1
7706	Screw No. 10-32 x 1/2" fill. hd. ....	-	-	1	1	1
5500	Lockwasher 3/16" .....	-	-	1	1	1
7003	Nut No. 10-32 .....	-	-	1	1	1
201570	Electrical wiring to brake pedal shaft bracket clip ....	-	-	-	1	1
197877	Electrical wiring clip (Single) .....	-	1	-	-	-
162552	Electrical wiring clip .....	-	2	-	-	-
5569	Electrical wiring clip screw .....	-	1	-	-	-
7003	Nut No. 10-32 .....	-	1	-	-	-
5500	Lockwasher .....	-	1	-	-	-
209542	Electrical wiring fender light cable fender insulator (Loom) .....	-	2	2	-	-
203317	Electrical wiring fender light cable fender insulator (Loom) .....	2	-	-	-	-
68073	Electrical wiring fender light cable clip .....	-	2	2	-	-
5568	Screw .....	-	2	2	-	-
5504	Lockwasher .....	-	2	2	-	-
7004	Nut 1/4-28 .....	-	2	2	-	-
166330	Electrical wiring fuse .....	2	2	2	1	1
202176	Electrical wiring fuse block assembly .....	1	-	-	-	-
223759	Electrical wiring fuse block assembly .....	-	-	-	1	1
215591	Electrical wiring fuse block assembly .....	-	1	1	-	-
5470	Screw 1/4-28 x 3/4" hex. hd. mach. ....	-	2	2	-	-
5923	Screw No. 10-32 x 2" fill. hd. mach. ....	2	-	-	-	-
145661	Screw No. 10-32 x 5/16" hex. hd. ....	-	-	-	2	-
3866	Washer 3/16" .....	-	-	-	2	2
5502	Lockwasher 1/4" .....	-	-	2	-	-
5500	Lockwasher 3/16" std. ....	2	-	-	2	1
7003	Nut No. 10-32 SAE std. ....	4	-	-	-	-
169547	Electrical wiring fuse block base .....	1	-	-	-	-
173367	Electrical wiring fuse block cable clip right .....	1	-	-	-	-
209347	Electrical wiring fuse block insulator .....	-	1	1	-	-
169550	Electrical wiring fuse block strap connector .....	2	-	-	-	-
169548	Insulator .....	2	-	-	-	-
5739	Electrical wiring fuse block terminal screw No. 10- 32 x 1/2" hex. hd. ....	-	-	-	1	1
5500	Lockwasher No. 10 .....	-	-	-	1	1
228539	Electrical wiring gasoline tank gauge cable clip .....	-	-	-	1	1
205139	Electrical wiring generator cable insulator (Loom) (5-1/2" long) .....	-	-	-	1	-
228965	Electrical wiring generator cable insulator (Loom) (15-1/2" long) .....	-	-	-	1	1
225386	Electrical wiring horn cable assembly-left .....	-	-	-	1	1
225387	Electrical wiring horn cable assembly-right .....	-	-	-	1	1

Piece No.	Name	No. Required				
		905 906	1005 1006	1107 1108	1207 1208	1407 1408
228953	Electrical wiring horn cable grommet .....	-	-	-	2	2
194272	Electrical wiring instrument board cable clip .....	2	2	3	-	-
197877	Electrical wiring instrument board cable clip .....	-	-	-	1	1
209742	Electrical wiring lamp cable insulator .....	-	4	4	-	-
157692	Electrical wiring lamp front cable to frame clip .....	1	-	-	-	-
5471	Electrical wiring lamp front cable to frame clip screw 1/4-28 x 3/4" hex. hd. ....	1	-	-	-	-
7004	Nut 1/4-28 .....	1	-	-	-	-
3874	Washer 5/16" plain .....	1	-	-	-	-
5502	Lockwasher 1/4" .....	1	-	-	-	-
194598	Electrical wiring lamp front cable clip .....	3	3	3	2	2
225375	Electrical wiring lamp front cable insulator .....	-	-	-	2	2
173367	Electrical wiring lamp front cable insulator to fender bracket .....	-	-	-	2	2
7710	Bolt No. 10-32 x 5/8" fill. hd. ....	-	-	-	2	2
7003	Nut No. 10-32 plain .....	-	-	-	2	2
5500	Lockwasher 3/16" .....	-	-	-	2	2
5430	Electrical wiring lamp front ground cable bolt 1/4-28 x 1/2" hex. hd. ....	-	-	-	1	1
7004	Nut 1/4-28 plain .....	-	-	-	1	1
3868	Washer 1/4" .....	-	-	-	1	-
5502	Lockwasher 1/4" .....	-	-	-	1	1
184478	Electrical wiring lamp rear right cable clip (Style No. 18) .....	2	-	-	-	-
5569	Screw No. 10-32 x 1/2" fill. hd. ....	2	-	-	-	-
5500	Lockwasher 3/16" .....	2	-	-	-	-
7003	Nut No. 10-32 plain .....	2	-	-	-	-
194465	Electrical wiring lamp rear left cable clip .....	1	-	-	-	-
194271	Electrical wiring lamp rear left cable clip (Style No. 18) .....	1	-	-	-	-
225415	Electrical wiring lamp rear insulator .....	-	-	-	2	2
201481	Electrical wiring motor support insulator (Loom) .....	1	1	1	-	-
201481	Electrical wiring radiator drain cock insulator (Loom) ..	-	-	2	-	-
209851	Electrical wiring rear channel cable clip .....	-	-	-	2	2
7003	Nut No. 10-32 .....	-	-	-	2	2
7706	Bolt No. 10-32 x 1/2" fill. hd. ....	-	-	-	2	2
5500	Lockwasher No. 10 .....	-	-	-	2	2
194271	Electrical wiring running board lamp cable clip .....	2	-	-	-	-
129773	Electrical wiring running board lamp cable clip .....	-	2	-	-	-
3866	Washer plain .....	2	-	-	-	-
7706	Bolt No. 10-32 x 1/2" fill. hd. ....	2	2	-	-	-
7003	Nut No. 10-32 .....	2	2	-	-	-
5500	Lockwasher No. 10 .....	2	2	-	-	-
203905	Electrical wiring running board lamp conduit strap clamp	2	2	-	-	-
197877	Electrical wiring steering gear to frame cable clip ....	1	1	1	-	-
162552	Electrical wiring steering gear to frame cable clip ....	-	-	1	-	-
7870	Screw 1/4-28 x 5/8" hex. hd. ....	1	-	-	-	-
5502	Lockwasher 1/4" .....	1	-	-	-	-
7004	Nut 1/4-28 plain .....	1	-	-	-	-
129773	Clip .....	1	-	-	-	-
225647	Electrical wiring steering gear lighting switch terminal block assembly .....	-	-	-	1	1
203377	Electrical wiring stop light cable insulator (Loom) ....	1	-	-	-	-
209851	Electrical wiring stop light switch cable clip .....	-	1	1	-	-
7706	Screw No. 10-32 x 1/2" fill. hd. ....	-	1	1	-	-
7003	Nut No. 10-32 .....	-	1	1	-	-
5500	Lockwasher 3/16" .....	-	1	1	-	-
203905	Electrical wiring strap clamp .....	-	3	2	-	-
197418	Electrical wiring toe board insulator (Loom) .....	1	1	-	-	-
219027	Electrical wiring toe board insulator left (Loom) .....	-	-	1	-	-

Piece No.	Name	No. Required				
		905 906	1005 1006	1107 1108	1207 1208	1407 1408
225083	Electrical wiring-toe board insulator left .....	-	-	-	1	1
225918	Electrical wiring assembly-toe board grommet-left .....	-	-	-	1	1
225919	Electrical wiring assembly-toe board grommet-right .....	-	-	-	1	1
219215	Electrical wiring toe board insulator right (Loom) .....	-	-	1	1	1
<b>EXHAUST</b>						
205521	Exhaust muffler assembly .....	-	1	-	-	-
215618	Exhaust muffler assembly .....	-	-	1	1	1
202863	Exhaust muffler assembly-rear .....	1	-	-	-	-
202862	Exhaust muffler assembly-front .....	1	-	-	-	-
207880	Exhaust muffler bracket-front .....	-	1	-	-	-
203101	Exhaust muffler bracket-front .....	1	-	-	-	-
215595	Exhaust muffler bracket-front .....	-	-	1	-	-
215765	Exhaust muffler bracket-front (Used on 1207-1407) .....	-	-	-	1	1
216266	Exhaust muffler bracket-front (Used on 1208-1408) .....	-	-	-	1	1
209484	Exhaust muffler bracket (front) "U" bolt .....	-	1	-	-	-
215592	Exhaust muffler bracket (front) "U" bolt .....	-	-	1	1	1
202909	Bolt 5/16-24 x 1-1/2" flat hd. ....	2	-	-	-	-
7005	Nut 5/16-24 plain .....	2	2	-	-	-
5504	Lockwasher 5/16" .....	2	2	-	-	-
202879	Exhaust muffler bracket-rear .....	1	-	-	-	-
207954	Exhaust muffler bracket-rear .....	-	1	-	-	-
215596	Exhaust muffler bracket-rear .....	-	-	1	-	-
215778	Exhaust muffler bracket-rear .....	-	-	-	1	1
202887	Exhaust muffler bracket (rear) "U" bolt .....	1	-	-	-	-
215593	Exhaust muffler bracket (rear) "U" bolt .....	-	-	1	-	-
215779	Exhaust muffler bracket (rear) "U" bolt .....	-	-	-	1	1
209775	Exhaust muffler bracket (rear) "U" bolt .....	-	1	-	-	-
5504	Lockwasher 5/16" std. ....	2	2	4	4	4
7005	Nut 5/16-24 SAE plain .....	2	2	4	4	4
190171	Exhaust muffler bracket cap .....	1	-	-	-	-
7822	Exhaust muffler bracket clamp screw 3/8-24 x 1-1/2" hex. hd. ....	2	-	-	-	-
186140	Exhaust muffler bracket clamp screw washer .....	4	-	-	-	-
5506	Lockwasher 3/8" .....	2	-	-	-	-
7006	Nut 3/8-24 SAE plain .....	2	-	-	-	-
7812	Exhaust muffler bracket to frame bolt 5/16-24 x 1-3/4" hex. hd. ....	-	4	4	-	-
5504	Lockwasher 5/16" .....	-	4	-	-	-
7705	Nut 5/16-24 plain .....	-	4	-	-	-
201813	Exhaust muffler bracket bolt sleeve .....	-	4	4	-	-
201812	Exhaust muffler bracket insulator .....	8	-	8	-	-
228634	Exhaust muffler bracket (rear) insulator (Supersedes 210214) .....	-	-	-	1	1
213203	Exhaust muffler bracket (rear) insulator bolt .....	-	-	-	5	5
228826	Bolt 5/16-24 x 1" hex. hd. special .....	-	-	-	3	3
183111	Bolt 5/16-24 x 1-1/8" hex. hd. ....	-	-	-	2	2
176864	Washer 5/16" special .....	-	-	-	5	5
7105	Nut 5/16-24 castle .....	-	-	-	5	5
4260	Cotter pin 1/16 x 1/2" .....	-	-	-	5	5
7812	Exhaust muffler bracket rear insulator screw 5/16-24 x 1-3/4" hex. hd. ....	4	-	-	-	-
3309	Washer 5/16" special .....	4	-	-	-	-
5504	Lockwasher 5/16" .....	4	-	-	-	-
7005	Nut 5/16-24 .....	4	-	-	-	-
228635	Exhaust muffler bracket (rear) insulator washer .....	-	-	-	2	2
209645	Exhaust muffler bracket (rear) and shock absorber control rod anti-rattler assembly .....	-	1	-	-	-

Piece No.	Name	No. Required				
		905 906	1005 1006	1107 1108	1207 1208	1407 1408
215597	Exhaust muffler bracket (rear) and shock absorber control rod anti-rattler assembly .....	-	-	1	-	-
197898	Exhaust muffler bracket shock absorber control rod anti-rattler .....	-	1	1	-	-
6327	Rivet tubular 24-9/64 x 3/8" .....	-	2	2	-	-
190718	Exhaust muffler front to rear clamp .....	1	-	-	-	-
7822	Screw 3/8-24 x 1-1/2" hex. hd. ....	1	-	-	-	-
5506	Lockwasher 3/8" .....	1	-	-	-	-
7006	Nut 3/8-24 plain .....	1	-	-	-	-
186140	Washer .....	2	-	-	-	-
207544	Exhaust muffler to frame bracket front assembly .....	-	-	-	1	1
7809	Screw 5/16-24 x 7/8" hex. hd. ....	-	-	-	1	1
6039	Screw 5/16-24 x 11/16" hex. hd. ....	-	-	-	3	1
5504	Lockwasher 5/16" .....	-	-	-	4	2
7005	Nut 5/16-24 .....	-	-	-	4	2
207582	Exhaust muffler to frame bracket front bolt plate .....	-	-	-	2	2
7809	Screw 5/16-24 x 7/8" hex. hd. ....	-	-	-	2	2
5504	Lockwasher 5/16" .....	-	-	-	2	2
7005	Nut 5/16-24 .....	-	-	-	2	2
225299	Exhaust muffler to frame bracket-rear .....	-	-	-	1	1
5449	Screw 5/16-24 x 3/4" hex. hd. ....	-	-	-	2	2
7005	Nut 5/16-24 .....	-	-	-	2	2
5504	Lockwasher 5/16" .....	-	-	-	2	2
201812	Exhaust muffler to frame bracket insulator .....	-	8	-	-	-
3909	Exhaust muffler to frame bracket insulator washer-thick. ....	-	4	-	-	-
3908	Exhaust muffler to frame bracket insulator washer-thin. ....	-	-	4	-	-
201811	Exhaust muffler to frame bracket insulator washer-thin. ....	-	8	4	-	-
6265	Exhaust muffler to frame bracket insulator washer 5/16" special (1005 only) .....	-	2	-	-	-
210035	Exhaust muffler heat deflector assembly .....	-	1	-	-	-
223243	Exhaust muffler heat deflector assembly-rear .....	-	-	-	1	1
215672	Exhaust muffler heat deflector assembly .....	-	-	1	-	-
228962	Exhaust muffler heat deflector assembly-front (Supersedes 215782) .....	-	-	-	1	1
210033	Exhaust muffler heat deflector bracket strap .....	-	4	-	-	-
215594	Exhaust muffler heat deflector bracket strap .....	-	-	4	4	4
7800	Screw 1/4-28 x 1" hex. hd. ....	-	2	2	2	2
5502	Lockwasher 1/4" .....	-	2	2	2	2
7004	Nut 1/4-28 .....	-	2	2	2	2
7824	Exhaust muffler heat deflector support screw 1/4-28 x 5/8" hex. hd. ....	-	-	-	2	2
5502	Lockwasher 1/4" .....	-	-	-	2	2
7004	Nut 1/4-28 .....	-	-	-	2	2
205735	Exhaust muffler outlet tube assembly .....	1	-	-	-	-
215741	Exhaust muffler outlet tube assembly .....	-	-	1	-	-
221871	Exhaust muffler outlet tube assembly .....	-	-	-	1	1
207935	Exhaust muffler outlet tube assembly .....	-	1	-	-	-
191960	Exhaust muffler outlet tube bracket-front .....	1	-	-	-	-
207905	Exhaust muffler outlet tube bracket-front .....	-	1	-	-	-
7822	Clamp screw 3/8-24 x 1-1/2" hex. hd. ....	-	1	-	-	-
186140	Washer .....	-	2	-	-	-
5506	Lockwasher 3/8" .....	-	1	-	-	-
7006	Nut 3/8-24 .....	-	1	-	-	-
7812	Exhaust muffler outlet tube bracket to frame bolt 5/16-24 x 1-3/4" hex. hd. ....	-	2	-	-	-
7005	Nut 5/16-24 .....	-	2	-	-	-
5504	Lockwasher 5/16" .....	-	2	-	-	-
201812	Exhaust muffler outlet tube bracket insulator .....	-	4	-	-	-
3909	Exhaust muffler outlet tube bracket insulator washer-thick .....	-	2	-	-	-

Piece No.	Name	No. Required				
		905 906	1005 1006	1107 1108	1207 1208	1407 1408
201311	Exhaust muffler outlet tube bracket insulator washer- thin .....	-	2	-	-	-
201180	Exhaust muffler outlet tube bracket-rear .....	1	1	-	-	-
7826	Exhaust muffler outlet tube bracket to frame bolt 5/16-24 x 5/8" hex. hd. ....	4	2	2	2	2
5504	Lockwasher 5/16" .....	4	2	2	2	2
7005	Nut 5/16-24 plain .....	4	2	2	2	2
7826	Exhaust muffler outlet tube bracket connection screw 5/16-24 x 5/8" hex. hd. ....	1	1	1	1	1
7005	Nut 5/16-24 plain .....	1	1	1	1	1
5504	Lockwasher 5/16" .....	1	1	1	1	1
215740	Exhaust muffler outlet tube to muffler clamp lower asb..	-	-	1	1	1
215739	Exhaust muffler outlet tube to muffler clamp upper .....	-	-	1	-	-
215739	Exhaust muffler outlet tube to muffler clamp .....	-	-	-	2	2
190718	Exhaust muffler outlet tube to muffler clamp .....	1	-	-	-	-
190729	Exhaust muffler outlet tube to muffler clamp .....	-	1	-	-	-
7822	Clamp screw 3/8-24 x 1-1/2" hex. hd. ....	2	2	-	-	-
7853	Clamp screw 3/8-24 x 1-1/8" hex. hd. ....	-	-	2	2	2
186140	Clamp screw washer .....	2	2	-	-	-
7006	Nut 3/8-24 plain .....	2	2	2	2	2
5506	Lockwasher 3/8" .....	2	2	2	2	2
213932	Exhaust muffler outlet tube to muffler clamp dowel .....	-	-	1	1	1
202615	Exhaust pipe assembly (Used on 905 only) .....	1	-	-	-	-
202614	Exhaust pipe assembly (Used on 906 only) .....	1	-	-	-	-
215743	Exhaust pipe assembly (Used on 1107 only) .....	-	-	1	-	-
223193	Exhaust pipe assembly (Used on 1207-1407) .....	-	-	-	1	1
223017	Exhaust pipe assembly (Used on 1208-1408) .....	-	-	-	1	1
215744	Exhaust pipe assembly (Used on 1108 only) .....	-	-	1	-	-
207925	Exhaust pipe assembly (Used on 1005 only) .....	-	1	-	-	-
207926	Exhaust pipe assembly (Used on 1006 only) .....	-	1	-	-	-
221484	Exhaust pipe clamp .....	-	-	-	1	1
7821	Exhaust pipe clamp screw 3/8-24 x 2-1/2" hex. hd. ....	-	-	-	2	2
7006	Exhaust pipe clamp screw nut 3/8-24 .....	-	-	-	2	2
5506	Exhaust pipe clamp screw lockwasher 3/8" .....	-	-	-	2	2
6295	Exhaust pipe to motor manifold screw 3/8-24 x 1-7/8" hex. hd. ....	-	4	4	4	4
6124	Exhaust pipe to exhaust manifold screw 3/8-24 x 1-3/4" hex. hd. ....	4	-	-	-	-
5506	Lockwasher .....	4	4	4	4	4
7406	Nut .....	4	4	4	4	4
3877	Washer .....	-	4	4	4	4
201167	Exhaust pipe flange front gasket .....	1	1	1	1	1
201179	Exhaust pipe to muffler clamp .....	1	1	1	-	-
7822	Screw 3/8-24 x 1-1/2" hex. hd. ....	1	1	1	-	-
186140	Washer .....	2	2	2	-	-
5506	Lockwasher 3/8" .....	1	1	1	-	-
7006	Nut 3/8-24 .....	1	1	1	-	-

## FENDER

(Specify color on all painted parts)

203109	Front fender right assembly (Specify color) (Without well) .....	1	-	-	-	-
205767	Front fender right assembly (Specify color) (Without well) .....	-	1	-	-	-
203653	Front fender right assembly (Specify color) (With well).	1	-	-	-	-
209098	Front fender right assembly (Specify color) (With well).	-	1	-	-	-
203110	Front fender left assembly (Specify color) (Without well) .....	1	-	-	-	-

Piece No.	Name	No. Required				
		905 906	1005 1006	1107 1108	1207 1208	1407 1408
205768	Front fender left assembly (Specify color) (Without well) .....	-	1	-	-	-
203652	Front fender left assembly (Specify color) (With well) .	1	-	-	-	-
209097	Front fender left assembly (Specify color) (With well) .	-	1	-	-	-
215136	Front fender left assembly (Specify color) (Without well) .....	-	-	1	-	-
215137	Front fender right assembly (Specify color) (Without well) .....	-	-	1	-	-
215359	Front fender left assembly (Specify color) (With well) .	-	-	1	-	-
215358	Front fender right assembly (Specify color) (With well).	-	-	1	-	-
221573	Front fender left assembly (Specify color) (Without well) .....	-	-	-	1	-
230162	Front fender left assembly (Specify color) (Without well) .....	-	-	-	-	1
225295	Front fender left assembly (Specify color) (With well) .	-	-	-	1	-
230295	Front fender left assembly (Specify color) (With well) .	-	-	-	-	1
221574	Front fender right assembly (Specify color) (Without well) .....	-	-	-	1	-
230163	Front fender right assembly (Specify color) (Without well) .....	-	-	-	-	1
225294	Front fender right assembly (Specify color) (With well).	-	-	-	1	-
230296	Front fender right assembly (Specify color) (With well).	-	-	-	-	1
225955	Front fender to body stud - 1/4" special .....	-	-	-	2	2
5502	Lockwasher 1/4" .....	-	-	-	2	2
7004	Nut 1/4-28 .....	-	-	-	2	2
62065	Washer 1/4" special .....	-	-	-	2	-
210721	Front fender brace left assembly .....	-	1	1	-	-
210720	Front fender brace right assembly .....	-	1	1	-	-
7608	Bolt 5/16-24 x 3/4" carriage .....	-	2	2	-	-
3874	Washer 5/16" .....	-	2	2	-	-
5504	Lockwasher 5/16" .....	-	2	2	-	-
7005	Nut 5/16-24 .....	-	2	2	-	-
216907	Front fender brace tube to fender anti-squeak .....	-	-	2	-	-
209440	Front fender bracket right assembly .....	-	1	1	-	-
223755	Front fender bracket right assembly .....	-	-	-	1	1
209441	Front fender bracket left assembly .....	-	1	1	-	-
223754	Front fender bracket left assembly .....	-	-	-	1	1
203846	Front fender bracket right .....	1	-	-	-	-
203845	Front fender bracket left .....	1	-	-	-	-
7826	Front fender bracket rear to frame bolt 5/16-24 x 5/8" hex. hd. ....	-	-	6	-	-
5504	Lockwasher 5/16" .....	-	-	6	-	-
7005	Nut 5/16-24 .....	-	-	6	-	-
7608	Front fender bracket front bolt 5/16-24 x 3/4" carriage.	-	-	4	4	4
3909	Washer-plain 5/16" .....	-	-	4	4	4
5504	Lockwasher 5/16" .....	-	-	4	4	4
7005	Nut 5/16-24 .....	-	-	4	4	4
7864	Front fender to bracket bolt screw 5/16-24 x 2-1/4" hex. hd. mach. ....	2	-	-	-	-
7005	Nut 5/16-24 plain .....	2	-	-	-	-
3874	Washer 5/16" plain .....	2	-	-	-	-
5504	Lockwasher 5/16" .....	2	-	-	-	-
225663	Front fender bracket to fender clamping plate liner ....	-	-	-	2	2
209422	Front fender bracket to fender liner .....	-	2	2	-	-
7809	Front fender bracket to frame bolt 5/16-24 x 7/8" hex. hd. ....	8	-	-	-	-
7818	Front fender bracket to frame bolt 3/8-24 x 7/8" hex. hd. ....	-	8	8	-	-
5504	Lockwasher 5/16" .....	8	-	-	-	-
5506	Lockwasher 3/8" .....	-	8	8	-	-



Piece No.	Name	No. Required				
		905 906	1005 1006	1107 1108	1207 1208	1407 1408
7005	Nut 5/16-24 plain .....	8	-	-	-	-
7006	Nut 3/8-24 .....	-	8	4	-	-
7951	Front fender bracket retaining screw 7/16-20 x 1-1/4" hex. hd. ....	-	-	-	8	8
5508	Lockwasher 7/16" .....	-	-	-	8	8
216347	Front fender to bracket shim - thick .....	-	-	x	-	-
216346	Front fender to bracket shim - intermediate .....	-	-	x	-	-
216345	Front fender to bracket shim - thin .....	-	-	x	-	-
225499	Front fender to fender liner .....	-	-	-	1	-
230176	Front fender left to fender right liner .....	-	-	-	-	1
7809	Screw 5/16-24 x 7/8" hex. hd. ....	-	-	-	2	-
7852	Screw 1/4-28 x 7/8" hex. hd. ....	-	-	-	-	2
5504	Lockwasher 5/16" .....	-	-	-	2	-
5502	Lockwasher 1/4" .....	-	-	-	-	2
7005	Nut 5/16-24 .....	-	-	-	2	-
7004	Nut 1/4-28 .....	-	-	-	-	2
7800	Front fender to frame bolt-long 1/4-28 x 1" hex. hd. ...	12	12	12	-	-
7827	Front fender to frame bolt-short 1/4-28 x 3/4" hex. hd..	2	2	2	-	-
5502	Lockwasher 1/4" .....	14	14	14	-	-
7004	Nut 1/4-28 plain .....	12	12	14	-	-
62065	Washer 17/64 x 3/4" plain .....	14	16	16	-	-
225259	Front fender to frame brace rod .....	-	-	-	2	2
225160	Front fender to frame brace rod insulator .....	-	-	-	4	4
5133	Washer 1/2" plain .....	-	-	-	4	4
6047	Washer 1/2" lock Shakeproof (extra heavy) .....	-	-	-	4	4
6189	Nut 1/2-20 .....	-	-	-	8	8
3884	Washer 1/2" plain .....	-	-	-	4	4
6345	Front fender to frame screw No. 14 (.251) x 1/2" binding hd. (Parker Kalon) .....	-	2	-	-	-
6352	Front fender to frame screw No. 14 (.243) x 5/8" binding hd. Type Z (Parker Kalon) .....	-	2	2	-	-
205952	Front fender to frame liner (Supersedes 191124) .....	2	-	-	-	-
213196	Front fender to frame liner .....	-	2	2	-	-
209912	Front fender to frame shield-right .....	-	1	1	-	-
209913	Front fender to frame shield-left .....	-	1	1	-	-
210047	Front fender to frame shield liner .....	-	2	2	-	-
7852	Front fender to radiator shell screw 1/4-28 x 7/8" hex. hd. ....	-	-	-	10	12
62065	Washer 1/4" special .....	-	-	-	10	18
5502	Lockwasher 1/4" .....	-	-	-	10	12
7004	Nut 1/4 .....	-	-	-	4	6
5412	Front fender to running board bolt 5/16-24 x 1" carriage	6	6	6	-	-
7600	Front fender to running board bolt 5/16-24 x 7/8" carriage .....	-	-	-	10	10
5504	Lockwasher 5/16" .....	6	6	6	10	10
7005	Nut 5/16-24 plain .....	6	6	6	10	10
7827	Front fender to running board to frame splasher bolt 1/4-28 x 3/4" hex. hd. mach. ....	8	10	10	-	-
5502	Lockwasher 1/4" .....	8	10	10	-	-
7004	Nut 1/4-28 plain .....	8	10	10	-	-
62065	Washer 17/64 x 3/4" plain .....	16	10	10	-	-
184839	Front fender to running board liner .....	2	2	2	-	-
223908	Front fender to running board liner .....	-	-	-	2	2
225255	Front fender shield-left .....	-	-	-	1	-
230172	Front fender shield-left .....	-	-	-	-	1
225256	Front fender shield-right .....	-	-	-	1	-
230174	Front fender shield-right .....	-	-	-	-	1
228650	Front fender shield to frame liner .....	-	-	-	2	2
21964	Rivet No. 632 - 9/64 x 5/16" tubular .....	-	-	-	26	-
139521	Rivet 5/32 x 7/16 oval head split .....	-	-	-	26	26

Piece No.	Name	No. Required				
		905 906	1005 1006	1107 1108	1207 1208	1407 1408
187642	Rear fender right assembly (Used on body 570) .....	1	-	-	-	-
187644	Rear fender right assembly (Used on bodies 571-581) ....	1	-	-	-	-
187076	Rear fender right assembly (Used on bodies 574-575) ....	1	-	-	-	-
187102	Rear fender right assembly (Used on bodies 573-583) ....	1	-	-	-	-
193922	Rear fender right assembly (Used on body 587) .....	1	-	-	-	-
187159	Rear fender right assembly (Used on body 576) .....	1	-	-	-	-
187589	Rear fender right assembly (Used on bodies 577-8-9) ....	1	-	-	-	-
187643	Rear fender left assembly (Used on body 570) .....	1	-	-	-	-
187645	Rear fender left assembly (Used on bodies 571-581) ....	1	-	-	-	-
187077	Rear fender left assembly (Used on bodies 574-575) ....	1	-	-	-	-
187103	Rear fender left assembly (Used on bodies 573-583) ....	1	-	-	-	-
193923	Rear fender left assembly (Used on body 587) .....	1	-	-	-	-
187160	Rear fender left assembly (Used on body 576) .....	1	-	-	-	-
187590	Rear fender left assembly (Used on bodies 577-8-9) ....	1	-	-	-	-
206304	Rear fender left assembly (Used on body 630) .....	-	1	-	-	-
206306	Rear fender left assembly (Used on bodies 631-641-D759) .	-	1	-	-	-
204583	Rear fender left assembly (Used on bodies 634-635) ....	-	1	-	-	-
204580	Rear fender left assembly (Used on bodies 633-643) ....	-	1	-	-	-
204577	Rear fender left assembly (Used on body 636) .....	-	1	-	-	-
206302	Rear fender left assembly (Used on bodies 637-8-9) ....	-	1	-	-	-
206061	Rear fender left assembly (Used on body 647) .....	-	1	-	-	-
213363	Rear fender left assembly (Specify color) (Used on body D758) .....	-	1	-	-	-
212364	Rear fender right assembly (Specify color) (Used on body D759) .....	-	1	-	-	-
206303	Rear fender right assembly (Used on body 630) .....	-	1	-	-	-
206305	Rear fender right assembly (Used on bodies 631-641) ....	-	1	-	-	-
204582	Rear fender right assembly (Used on bodies 634-635-D759)	-	1	-	-	-
204579	Rear fender right assembly (Used on bodies 633-643) ....	-	1	-	-	-
204576	Rear fender right assembly (Used on body 636) .....	-	1	-	-	-
206301	Rear fender right assembly (Used on bodies 637-8-9) ....	-	1	-	-	-
206060	Rear fender right assembly (Used on body 647) .....	-	1	-	-	-
212507	Rear fender left assembly (Used on bodies 734-735) ....	-	-	1	-	-
212505	Rear fender left assembly (Used on bodies 732-733-743) .	-	-	1	-	-
212503	Rear fender left assembly (Used on body 736) .....	-	-	1	-	-
212499	Rear fender left assembly (Used on bodies 737-738-739) .	-	-	1	-	-
212501	Rear fender left assembly (Used on body 747) .....	-	-	1	-	-
212495	Rear fender left assembly (Used on body 730) .....	-	-	1	-	-
212497	Rear fender left assembly (Used on bodies 731-741) ....	-	-	1	-	-
214987	Rear fender left assembly (Specify color) (Use on body D859) .....	-	-	1	-	-
214989	Rear fender left assembly (Specify color) (Use on body D858) .....	-	-	1	-	-
214986	Rear fender right assembly (Specify color) (Use on body D859) .....	-	-	1	-	-
214988	Rear fender right assembly (Specify color) (Use on body D858) .....	-	-	1	-	-
212506	Rear fender right assembly (Used on bodies 734-735) ....	-	-	1	-	-
212504	Rear fender right assembly (Used on bodies 732-733-743) .	-	-	1	-	-
212502	Rear fender right assembly (Used on body 736) .....	-	-	1	-	-
212498	Rear fender right assembly (Used on bodies 737-8-9) ....	-	-	1	-	-
212500	Rear fender right assembly (Used on body 747) .....	-	-	1	-	-
212494	Rear fender right assembly (Used on body 730) .....	-	-	1	-	-
212496	Rear fender right assembly (Used on bodies 731-741) ....	-	-	1	-	-
220383	Rear fender left assembly (Specify color) (Used on bodies 832-33-34-35-821-30-31-873-L194-L195-932-33-34- 35-921-30-31-73-L294-L295) .....	-	-	-	1	1
224653	Rear fender left assembly (Specify color) (Used on body 836-936) .....	-	-	-	1	1

Piece No.	Name	No. Required				
		905 906	1005 1006	1107 1108	1207 1208	1407 1408
224655	Rear fender left assembly (Specify color) (Used on bodies 837-38-39-27-937-38-39-27) .....	-	-	-	1	1
220982	Rear fender right assembly (Specify color) (Used on bodies 832-33-34-35-821-30-31-73-L194-L195-932-33-34-35-21-30-31-73-L294-L295) .....	-	-	-	1	1
224652	Rear fender right assembly (Specify color) (Used on bodies 836-936) .....	-	-	-	1	1
224654	Rear fender right assembly (Specify color) (Used on bodies 837-38-39-27-937-38-39-27) .....	-	-	-	1	1
211788	Rear fender to body liner (Used on bodies 638-639-738-9) .....	-	2	2	-	-
211787	Rear fender to body liner (Used on bodies 637-737) .....	-	2	2	-	-
211785	Rear fender to body liner (Used on bodies 634-635-734-5-D858-D859) .....	-	2	2	-	-
212156	Rear fender to body liner (Used on body 647) .....	-	2	-	-	-
218332	Rear fender to body liner (Specify color) (Used on body 747) .....	-	-	2	-	-
211790	Rear fender to body liner (Used on bodies 631-641-731-741) .....	-	2	2	-	-
211786	Rear fender to body liner (Used on body 636) .....	-	2	-	-	-
212326	Rear fender to body liner (Used on body 736) .....	-	-	2	-	-
211789	Rear fender to body liner (Used on bodies 630-730) .....	-	2	2	-	-
211784	Rear fender to body liner (Used on bodies 633-643-732-733-743) .....	-	2	2	-	-
148957	Rear fender to body liner (Bulk) .....	X	-	-	-	-
220978	Rear fender to body liner (Spec. color) (Used on bodies 832-33-34-35-73-30-31-21-L194-L195-932-33-34-35-73-30-31-21-L294-L295) .....	-	-	-	2	2
224885	Rear fender to body liner (Spec. color) (Used on bodies 836-936) .....	-	-	-	2	2
224886	Rear fender to body liner (Spec. color) (Used on bodies 837-8-9-27-937-38-39-27) .....	-	-	-	2	2
5381	Rear fender to body screw 5/16-24 x 7/8" rnd. hd. ....	X	X	-	-	-
7809	Rear fender to body screw 5/16-24 x 7/8" hex. hd. mach. .	-	X	X	X	X
7861	Rear fender to body screw 1/4-28 x 1" hex. hd. ....	X	X	X	X	X
7812	Rear fender to body screw 5/16-24 x 1-3/4" hex. hd. ....	-	-	-	X	X
5449	Screw 5/16-24 x 3/4" hex. hd. ....	-	-	-	X	X
5504	Lockwasher 5/16" std. ....	X	X	X	X	X
5385	Lockwasher 5/16" Shakeproof .....	X	-	-	-	-
162389	Rear fender to body bolt washer .....	X	X	X	X	X
3909	Washer 5/16" .....	X	X	X	X	X
6427	Rear fender to body stud 5/16-24 special .....	-	-	-	2	2
7005	Nut 5/16-24 .....	-	-	-	2	2
7827	Rear fender to frame rear end splasher screw 1/4-28 x 3/4" hex. hd. ....	8	8	8	-	-
62065	Washer 17/64 x 3/4" plain .....	12	12	12	-	-
5502	Lockwasher 1/4" .....	8	8	8	-	-
7004	Nut 1/4-28 plain .....	8	8	8	-	-
226028	Rear fender pebble guard-right .....	-	-	-	1	1
226029	Rear fender pebble guard-left .....	-	-	-	1	1
7827	Screw 1/4-28 x 3/4" hex. hd. ....	-	-	-	6	8
3870	Washer 1/4 plain .....	-	-	-	10	10
5502	Lockwasher 1/4" .....	-	-	-	6	8
7004	Nut 1/4-28 .....	-	-	-	6	8
187580	Rear fender to running board liner-right .....	1	-	-	-	-
187581	Rear fender to running board liner-left .....	1	-	-	-	-
187582	Rear fender to running board and splasher liner-left ..	1	-	-	-	-
187583	Rear fender to running board and splasher liner-right ..	1	-	-	-	-
7600	Rear fender to running board-bolt 5/16-24 x 7/8" carriage .....	6	6	6	6	6

Piece No.	Name	No. Required				
		905 906	1005 1006	1107 1108	1207 1208	1407 1408
5449	Screw 5/16-24 x 3/4" hex. hd. ....	-	-	-	2	2
3909	Washer 5/16 special .....	-	-	-	4	4
5504	Lockwasher 5/16" .....	6	6	6	8	8
7005	Nut 5/16-24 plain .....	6	6	6	8	8
7827	Screw 1/4-28 x 3/4" hex. hd. machine .....	4	4	4	-	-
7852	Screw 1/4-28 x 7/8" hex. hd. ....	2	2	2	-	-
62065	Washer 17/64 x 3/4" plain .....	12	12	12	-	-
5502	Lockwasher 1/4" .....	6	6	6	-	-
7004	Nut 1/4-28 plain .....	6	6	6	-	-
5286	Rear fender to trunk screw No. 10-32 x 1" round head (Used with body 747) .....	-	-	6	-	-
3867	Washer 3/16" (Used with body 747) .....	-	-	6	-	-
5500	Lockwasher No. 10 (Used with body 747) .....	-	-	6	-	-
7003	Nut No. 10-32 (Used with body 747) .....	-	-	6	-	-
213946	Rear fender skirt reinforcement-left .....	-	-	1	-	-
213947	Rear fender skirt reinforcement-right .....	-	-	1	-	-
7827	Rear fender skirt reinforcement screw 1/4-28 x 3/4" hex. hd. ....	-	-	5	-	-
3870	Washer 1/4" .....	-	-	5	-	-
5502	Lockwasher 1/4" .....	-	-	5	-	-
7004	Nut 1/4-28 .....	-	-	5	-	-
176864	Spacer washer .....	-	-	3	-	-

## FRAME

202698	Frame assembly (Used on 905 only) .....	1	-	-	-	-
202697	Frame assembly (Used on 906 only) .....	1	-	-	-	-
203566	Frame assembly (Used on 1005 only) .....	-	1	-	-	-
203567	Frame assembly (Used on 1006 only) .....	-	1	-	-	-
215372	Frame assembly (Used on 1107) .....	-	-	1	-	-
215373	Frame assembly (Used on 1108) .....	-	-	1	-	-
223470	Frame assembly (Used on 1207-1407) .....	-	-	-	1	1
223471	Frame assembly (Used on 1208-1408) .....	-	-	-	1	1
207392	Frame battery support front assembly (Used on 1005 only) .....	-	1	-	-	-
207394	Frame battery support front assembly (Used on 1006 only) .....	-	1	-	-	-
215269	Frame battery support front assembly (Used on 11108) ...	-	-	1	-	-
215268	Frame battery support front assembly (Used on 1107) ....	-	-	1	-	-
215287	Frame battery support rear assembly (Used on 1107) .....	-	-	1	-	-
215288	Frame battery support rear assembly (Used on 1108) .....	-	-	1	-	-
207409	Frame battery support rear (Used on 1005 only) .....	-	1	-	-	-
207410	Frame battery support rear (Used on 1006 only) .....	-	1	-	-	-
186737	Frame to body hold down bolt bracket .....	6	6	6	-	-
223005	Frame to body hold down bolt bracket .....	-	-	-	4	4
223007	Frame to body hold down bolt bracket-left .....	-	-	-	2	2
223500	Frame to body hold down bolt bracket-right .....	-	-	-	2	2
5449	Screw 5/16-24 x 3/4" hex. hd. (Used on 1207-1407) ..	-	-	-	8	8
5504	Lockwasher 5/16 (Used on 1207-1407) .....	-	-	-	8	8
7005	Nut 5/16-24 (Used on 1207-1407) .....	-	-	-	8	8
223446	Frame body bolt spacer .....	-	-	-	2	2
186739	Frame body bolt spacer .....	2	2	2	2	2
223429	Frame bumper rear bracket-left .....	-	-	-	1	1
223430	Frame bumper rear bracket-right .....	-	-	-	1	1
190787	Frame front axle spring bracket rear left .....	1	1	1	-	-
223533	Frame front axle spring bracket rear left .....	-	-	-	1	1
195993	Frame front axle spring bracket rear right .....	1	1	1	-	-
223534	Frame front axle spring bracket rear right .....	-	-	-	1	1
194430	Frame front axle spring shackle bracket assembly left ..	1	1	1	-	-
228563	Frame front axle spring shackle bracket assembly left (Prior to frame No. 903430) .....	-	-	-	1	-

Piece No.	Name	No. Required				
		905 906	1005 1006	1107 1108	1207 1208	1407 1408
194431	Frame front axle spring shackle bracket assembly right .	1	1	1	-	-
228564	Frame front axle spring shackle bracket assembly right (Prior to frame No. 903430) .....	-	-	-	1	-
230146	Frame front axle spring shackle bracket assembly left (After frame No. 903429) .....	-	-	-	1	1
230147	Frame front axle spring shackle bracket assembly right (After frame No. 903429) .....	-	-	-	1	1
158375	Frame front axle spring shackle bracket bushing .....	2	2	2	2	2
186954	Frame front axle spring shackle bracket rivet long special .....	2	2	2	2	-
190804	Frame front channel assembly .....	1	1	1	-	-
223556	Frame front channel assembly .....	-	-	-	1	1
186888	Frame front end cross tube assembly (Used on 905-1005- 1107) .....	1	1	1	-	-
190342	Frame front end cross tube assembly (Used on 906-1006- 1108) .....	1	1	1	-	-
203116	Frame front intermediate channel assembly (Used on 905 only) .....	1	-	-	-	-
203117	Frame front intermediate channel assembly (Used on 906 only) .....	1	-	-	-	-
201885	Frame front intermediate channel assembly (Used on 1005 only) .....	-	1	-	-	-
201128	Frame front intermediate channel assembly (Used on 1006 only) .....	-	1	-	-	-
215356	Frame front intermediate channel assembly (Used on 1107)	-	-	1	-	-
215243	Frame front intermediate channel assembly (Used on 1108)	-	-	1	-	-
202620	Frame motor support bracket rear left .....	1	-	-	-	-
202621	Frame motor support bracket rear right .....	1	-	-	-	-
191325	Frame rear axle spring bracket front right .....	1	-	-	-	-
201103	Frame rear axle spring bracket front right .....	-	1	1	-	-
223454	Frame rear axle spring bracket front right .....	-	-	-	1	1
191324	Frame rear axle spring bracket front left .....	1	-	-	-	-
201102	Frame rear axle spring bracket front left .....	-	1	1	-	-
223455	Frame rear axle spring bracket front left .....	-	-	-	1	1
186956	Frame rear axle spring rubber bumper reinforcement left.	1	1	1	1	1
186957	Frame rear axle spring rubber bumper reinforcement right	1	1	1	1	1
194436	Frame rear axle spring shackle bracket assembly left (Used on 905-1005-1107) .....	1	1	1	-	-
194433	Frame rear axle spring shackle bracket assembly right (Used on 905-1005-1107) .....	1	1	1	-	-
194434	Frame rear axle spring shackle bracket assembly right (Used on 906-1006-1108) .....	1	1	1	-	-
194437	Frame rear axle spring shackle bracket assembly left (Used on 906-1006-1108) .....	1	1	1	-	-
228566	Frame rear axle spring shackle bracket assembly left ...	-	-	-	1	1
228568	Frame rear axle spring shackle bracket assembly right ..	-	-	-	1	1
180585	Frame rear axle spring shackle bracket bushing .....	2	2	2	2	2
186704	Frame rear channel (Used on 905 only) .....	1	-	-	-	-
190346	Frame rear channel (Used on 906 only) .....	1	-	-	-	-
205292	Frame rear channel (Used on 1005-1107) .....	-	1	1	-	-
205293	Frame rear channel (Used on 1006-1108) .....	-	1	1	-	-
221707	Frame rear channel .....	-	-	-	1	1
213629	Frame rear end splash bar (Used on body 636) .....	2	-	-	-	-
191269	Frame rear end splash bar (Not used on body 636-736) .	2	2	2	-	-
191658	Screw .....	8	8	8	-	-
5447	Lockwasher .....	8	8	8	-	-
205671	Frame rear intermediate channel .....	-	1	1	-	-
221728	Frame rear intermediate channel .....	-	-	-	1	1
194671	Frame rear intermediate channel .....	1	-	-	-	-

Piece No.	Name	No. Required				
		905 906	1005 1006	1107 1108	1207 1208	1407 1408
228610	Frame shock absorber front bracket-right .....	-	-	-	1	1
228609	Frame shock absorber front bracket-left .....	-	-	-	1	1
202937	Frame side left (Used on 905 only) .....	1	-	-	-	-
202938	Frame side left (Used on 906 only) .....	1	-	-	-	-
201099	Frame side left (Used on 1005 only) .....	-	1	-	-	-
201090	Frame side left (Used on 1006 only) .....	-	1	-	-	-
201095	Frame side right (Used on 1005 only) .....	-	1	-	-	-
201092	Frame side right (Used on 1006 only) .....	-	1	-	-	-
202942	Frame side right (Used on 905 only) .....	1	-	-	-	-
202939	Frame side right (Used on 906 only) .....	1	-	-	-	-
215241	Frame side left (Used on 1108) .....	-	-	1	-	-
215367	Frame side left (Used on 1107) .....	-	-	1	-	-
223483	Frame side left (Used on 1207-1407) .....	-	-	-	1	1
223315	Frame side left (Used on 1208-1408) .....	-	-	-	1	1
223484	Frame side right (Used on 1207-1407) .....	-	-	-	1	1
223334	Frame side right (Used on 1208-1408) .....	-	-	-	1	1
215242	Frame side right (Used on 1108) .....	-	-	1	-	-
215368	Frame side right (Used on 1107) .....	-	-	1	-	-
223947	Frame wheel carrier spacer assembly-rear upper left ....	-	-	-	1	1
223946	Frame wheel carrier spacer assembly-rear upper right ...	-	-	-	1	1
228637	Frame wheel carrier spacer-front upper right .....	-	-	-	1	1
228636	Frame wheel carrier spacer-front upper left .....	-	-	-	1	1
228639	Frame wheel carrier spacer-lower right .....	-	-	-	1	1
228638	Frame wheel carrier spacer-lower left .....	-	-	-	1	1
223538	Frame X member (Used on 1207-1407) .....	-	-	-	1	1
223565	Frame X member (Used on 1208-1408) .....	-	-	-	1	1

## FRONT AXLE

197577	Front axle .....	1	-	-	-	-
209375	Front axle .....	-	1	-	-	-
209376	Front axle .....	-	-	1	-	-
223311	Front axle .....	-	-	-	1	1
190548	Front axle steering cross tube .....	1	-	-	-	-
202761	Front axle steering cross tube .....	-	1	1	-	-
223381	Front axle steering cross tube .....	-	-	-	1	1
126145	Front axle steering cross tube ball joint .....	2	-	-	-	-
209387	Front axle steering cross tube ball joint .....	-	2	2	2	2
4551	Key No. 5 Whitney .....	2	-	-	-	-
7109	Nut 9/16-18 castle .....	2	2	2	2	2
4306	Cotter spring 1/8 x 1" .....	2	2	2	2	2
128082	Front axle steering cross tube ball joint dust shield ..	2	2	2	2	2
114211	Front axle steering cross tube ball joint dust shield shim .....	x	x	x	2	2
116886	Front axle steering cross tube ball joint lubricator connector (Alemite Type A male No. 345) .....	-	2	2	-	-
216549	Front axle steering cross tube ball joint lubricator connector (Alemite Zerk Type 1612) .....	-	-	2	2	2
116272	Connector dust cap (Alemite) .....	-	2	2	-	-
126149	Front axle steering cross tube ball socket lower .....	2	2	2	2	2
126148	Front axle steering cross tube ball socket upper .....	2	2	2	2	2
202958	Front axle steering cross tube ball socket casing .....	2	-	-	-	-
202760	Front axle steering cross tube ball socket casing .....	-	2	2	2	2
5561	Screw 7/16-20 x 1-7/8" hex. hd. .....	2	2	2	2	2
7007	Nut 7/16-20 .....	2	2	2	2	2
5508	Lockwasher 7/16" .....	2	2	2	2	2
137109	Front axle steering cross tube ball socket casing cap ..	2	-	-	-	-
202762	Front axle steering cross tube ball socket casing cap ..	-	2	2	2	2



Piece No.	Name	No. Required				
		905 906	1005 1006	1107 1108	1207 1208	1407 1408
7827	Screw 1/4-28 x 3/4" hex. hd. ....	4	4	4	4	4
5502	Lockwasher 1/4" .....	4	4	4	4	4
126151	Front axle steering cross tube ball socket casing gasket	2	2	2	2	2
132526	Front axle steering cross tube ball socket spring .....	2	2	2	2	2
201554	Front axle steering knuckle .....	2	2	-	-	-
215248	Front axle steering knuckle .....	-	-	2	2	2
5692	Screw 3/8-24 x 1/2" hex. hd. ....	2	2	2	2	2
5506	Lockwasher 3/8" .....	2	2	2	2	2
118228	Front axle steering knuckle adjusting nut 7/8-14" SAE std. (Special) .....	4	4	4	4	4
4320	Cotter pin 5/32 x 1-1/8" .....	2	2	2	2	2
118230	Front axle steering knuckle adjusting nut lockwasher ...	2	2	2	2	2
43293	Front axle steering knuckle adjusting nut pin .....	2	2	2	2	2
139769	Front axle steering knuckle bearing inboard (Timken No. 3383) .....	2	2	2	2	2
97056	Front axle steering knuckle bearing outboard (Timken No. 2687) .....	2	2	2	2	2
125433	Front axle steering knuckle bearing inboard dust washer.	2	2	2	2	2
137153	Front axle steering knuckle bearing inboard dust washer retainer .....	4	4	4	4	4
137142	Front axle steering knuckle bearing inboard spacer asb..	2	2	2	2	2
146088	Front axle steering knuckle lever right .....	1	-	-	-	-
207417	Front axle steering knuckle lever right .....	-	1	1	-	-
223308	Front axle steering knuckle lever right .....	-	-	-	1	1
182283	Front axle steering knuckle lever left and oil tube asb.	1	-	-	-	-
207416	Front axle steering knuckle lever left .....	-	1	1	-	-
223309	Front axle steering knuckle lever left .....	-	-	-	1	1
126495	Screw 7/16-20 x 2-3/32" hex. hd. ....	4	4	4	4	4
4291	Cotter pin 3/32 x 3/4" .....	4	4	4	4	4
7107	Nut 7/16-20 castle .....	4	4	4	4	4
163477	Front axle steering knuckle lever left oil tube .....	1	-	-	-	-
132142	Front axle steering knuckle lever ball joint .....	1	-	-	-	-
197145	Front axle steering knuckle lever ball joint .....	-	1	1	1	1
4551	Key No. 5 Whitney (Woodruff system) .....	1	-	-	-	-
7109	Nut 9/16-18 castle .....	1	1	1	1	1
4306	Cotter pin 1/8 x 1" .....	1	1	1	1	1
114211	Front axle steering knuckle lever ball joint cup washer.	2	2	2	2	2
114316	Front axle steering knuckle lever ball joint plain washer .....	1	1	1	1	1
163207	Front axle steering knuckle oil guard .....	2	2	2	2	2
197576	Front axle steering knuckle pin .....	2	2	-	-	-
215105	Front axle steering knuckle pin .....	-	-	2	2	2
114955	Lubricator connector (Alemite Type "A" male) .....	2	-	-	-	-
116272	Lubricator connector dust cap (Alemite) .....	2	-	-	-	-
215187	Front axle steering knuckle pin bearing lower washer ...	-	-	2	2	2
148884	Front axle steering knuckle pin bearing upper spring washer .....	4	4	-	-	-
215254	Front axle steering knuckle pin bearing upper spring washer .....	-	-	4	4	4
201020	Front axle steering knuckle pin bearing assembly .....	4	-	-	-	-
213142	Front axle steering knuckle pin bearing assembly .....	-	4	-	-	-
215249	Front axle steering knuckle pin bearing assembly .....	-	-	4	4	4
201023	Front axle steering knuckle pin bearing packing .....	4	-	-	-	-
213145	Front axle steering knuckle pin bearing packing .....	-	4	-	-	-
215252	Front axle steering knuckle pin bearing packing .....	-	-	4	-	-
213146	Front axle steering knuckle pin bearing packing retainer	4	4	-	-	-
197150	Front axle steering knuckle pin key .....	2	2	2	2	2
201496	Front axle steering knuckle shim (.005) .....	x	x	-	-	-
215184	Front axle steering knuckle shim (.005) .....	-	-	x	x	x

Piece No.	Name	No. Required				
		905 906	1005 1006	1107 1108	1207 1208	1407 1408
201497	Front axle steering knuckle shim (.025) .....	X	X	-	-	-
215183	Front axle steering knuckle shim (.025) .....	-	-	X	X	X
180803	Front axle steering knuckle stop screw .....	2	2	2	2	2
7006	Nut 3/8-24 SAE plain .....	2	2	2	2	2

## GASOLINE

213347	Gasoline fuel pump inlet hose assembly .....	-	-	1	-	-
201216	Gasoline tank assembly .....	1	-	-	-	-
213787	Gasoline tank assembly .....	-	-	1	-	-
210261	Gasoline tank assembly .....	-	1	-	-	-
5422	Gasoline tank drain plug 1/4" hex. hd. ....	1	-	-	-	-
6341	Gasoline tank drain plug 3/8" countersunk hd. ....	-	1	1	-	-
5423	Gasoline tank drain plug 3/8" hex. hd. ....	-	-	1	-	-
190175	Gasoline tank to frame rear channel bracket lower .....	1	-	-	-	-
210252	Gasoline tank to frame rear channel bracket lower .....	-	1	-	-	-
213770	Gasoline tank to frame rear channel bracket lower .....	-	-	1	-	-
190174	Gasoline tank to frame rear channel bracket upper .....	1	-	-	-	-
210251	Gasoline tank to frame rear channel bracket upper .....	-	1	-	-	-
213769	Gasoline tank to frame rear channel bracket upper .....	-	-	1	-	-
7809	Bolt 5/16-24 x 7/8" hex. hd. ....	2	-	-	-	-
7828	Bolt 5/16-24 x 1-1/8" hex. hd. ....	-	2	2	-	-
5504	Lockwasher 5/16" .....	2	2	2	-	-
7005	Nut 5/16-24 plain .....	2	2	2	-	-
190134	Gasoline tank to frame rear intermediate channel bracket lower .....	2	-	-	-	-
210250	Gasoline tank to frame rear intermediate channel bracket lower .....	-	2	-	-	-
213772	Gasoline tank to frame rear intermediate channel bracket lower .....	-	-	2	-	-
190135	Gasoline tank to frame rear intermediate channel bracket upper .....	2	-	-	-	-
210249	Gasoline tank to frame rear intermediate channel bracket upper .....	-	2	-	-	-
213773	Gasoline tank to frame rear intermediate channel bracket upper .....	-	-	2	-	-
7809	Bolt 5/16-24 x 7/8" hex. hd. ....	4	-	-	-	-
7828	Bolt 5/16-24 x 1-1/8" hex. hd. ....	-	4	4	-	-
5504	Lockwasher 5/16" .....	4	4	4	-	-
7005	Nut 5/16-24 plain hex. ....	4	4	4	-	-
210654	Gasoline tank to frame rear channel bracket spacer .....	-	X	-	-	-
210654	Gasoline tank to frame rear intermediate channel bracket spacer .....	-	4	-	-	-
191222	Gasoline tank to frame junction tube assembly .....	1	-	-	-	-
207671	Gasoline tank to frame junction tube assembly .....	-	1	1	-	-
5466	Union nut 5/16" flared tube .....	1	-	-	-	-
5468	Union nut 3/8" flared tube .....	-	1	1	-	-
6276	Nut 3/8" flared tube inverted .....	-	-	1	-	-
191204	Gasoline tank to motor carburetor frame junction .....	1	-	-	-	-
5915	Lockwasher 11/16" .....	1	-	-	-	-
190680	Nut 11/16-16 .....	1	-	-	-	-
6278	Union nut flared tube .....	2	-	-	-	-
201223	Gasoline tank gauge assembly .....	1	-	-	-	-
210299	Gasoline tank gauge assembly (After frame No. 901200) ..	-	1	-	-	-
210260	Gasoline tank gauge assembly (Prior to frame No. 901201)	-	1	-	-	-
215016	Gasoline tank gauge assembly .....	-	-	1	-	-
5569	Screw No. 10-32 x 1/2" fill. head .....	5	5	5	-	-
203084	Gasket .....	1	1	1	-	-

Piece No.	Name	No. Required				
		905 906	1005 1006	1107 1108	1207 1208	1407 1408
169041	Gasoline tank gauge tube bushing .....	1	1	1	-	-
190845	Gasoline tank inlet cover assembly .....	1	1	-	-	-
201779	Gasoline tank inlet cover assembly .....	-	-	1	-	-
190847	Gasoline tank inlet cover gasket .....	1	1	1	-	-
213923	Gasoline tank inlet gasket .....	-	-	1	-	-
5486	Gasoline tank inlet to lamp bracket screw No. 10-32 x 1-1/8 .....	-	-	3	-	-
5500	Lockwasher 3/16" .....	-	-	3	-	-
213911	Gasoline tank inlet tube assembly .....	-	-	1	-	-
6356	Rivet .....	-	-	3	-	-
7824	Gasoline tank inlet tube flange screw 1/4-28 x 5/8 hex. hd. ....	-	-	8	-	-
5502	Lockwasher 1/4 .....	-	-	8	-	-
213919	Gasoline tank inlet screw bracket .....	-	-	3	-	-
213762	Gasoline tank inlet tube flange to tank flange gasket ..	-	-	1	-	-
215255	Gasoline tank inlet tube flexible coupling .....	-	-	1	-	-
210259	Gasoline tank support bracket front .....	-	2	2	-	-
213768	Gasoline tank support bracket front reinforcement .....	-	-	2	-	-
210258	Gasoline tank support bracket front reinforcement .....	-	2	-	-	-
210257	Gasoline tank support bracket rear reinforcement .....	-	1	1	-	-
6336	Rivet .....	-	12	12	-	-
213058	Gasoline tank support bracket rear reinforcement .....	-	1	1	-	-
6356	Rivet .....	-	8	8	-	-
114141	Gasoline tank support bracket screw .....	3	3	3	-	-
7007	Nut 7/16-20 plain SAE .....	3	3	3	-	-
120813	Lockwire (5" long) .....	3	3	3	-	-
202767	Gasoline tube front assembly (Used on 905 only) .....	1	-	-	-	-
202766	Gasoline tube front assembly (Used on 906 only) .....	1	-	-	-	-
5466	Union nut 5/16" flared tube .....	1	-	-	-	-
5867	Union nut 5/16" flared tube .....	1	-	-	-	-
183076	Gasoline tube front clip .....	5	-	-	-	-
184834	Gasoline tube front clip .....	1	-	-	-	-
7710	Screw No. 10-32 x 5/8" fill. hd. ....	1	-	-	-	-
3867	Washer 3/16" plain .....	1	-	-	-	-
5500	Lockwasher No. 10 .....	1	-	-	-	-
7003	Nut No. 10-32 SAE .....	1	-	-	-	-
207666	Gasoline tube frame to fuel pump assembly .....	-	1	-	-	-
6276	Nut flared tube inverted (Weatherhead) .....	-	1	-	-	-
5468	Nut .....	-	1	-	-	-
209223	Gasoline tube frame junction .....	-	2	2	-	-
6280	Lockwasher 7/8" (Shakeproof) .....	-	2	2	-	-
209222	Nut 7/8-14 .....	-	2	2	-	-
6276	Nut 3/8" flared tube inverted (Weatherhead) .....	-	4	-	-	-
216747	Gasoline tube outer assembly (Used on 1005-1107) (Supersedes 209360) .....	-	1	1	-	-
216751	Gasoline tube outer assembly (Used on 1006-1108) (Supersedes 209361) .....	-	1	1	-	-
79005	Clip .....	-	1	2	-	-
68073	Clip .....	-	-	1	-	-
7710	Screw No. 10-32 x 5/8" fill. hd. ....	-	1	2	-	-
3867	Washer 3/16" .....	-	1	2	-	-
5500	Lockwasher No. 10 .....	-	1	2	-	-
7003	Nut No. 10-32 .....	-	1	2	-	-
209611	Clip boltless .....	-	5	4	-	-
6276	Nut 3/8 inverted .....	-	-	2	-	-
216655	Gasoline tube outer to frame shield .....	-	-	1	-	-
6352	Screw .....	-	-	2	-	-

Piece No.	Name	No. Required				
		905 906	1005 1006	1107 1108	1207 1208	1407 1408
<b>GASOLINE</b>						
228755	Gasoline fuel pump inlet tube assembly (Supersedes 225680) .....	-	-	-	1	1
223341	Gasoline tank assembly (Used with bodies 832-33-34-35-821-31-30-L194-L195-932-33-34-35-21-31-30-L294-L295) .	-	-	-	1	1
225510	Gasoline tank assembly (Use with bodies 827-36-37-38-39-73-927-36-37-38-39-73) .....	-	-	-	1	1
5423	Gasoline tank drain plug 3/8 hex. hd. ....	-	-	-	1	1
223237	Gasoline tank to frame bracket rear left (Use with bodies 832-33-34-35-L194-L195-932-33-34-35-L294-L295).	-	-	-	1	1
223238	Gasoline tank to frame bracket rear right (Use with bodies 833-34-35-832-L194-L195-932-33-34-35-L294-L295)	-	-	-	1	1
6039	Screw 5/16-24 x 11/16 hex. hd. (Use with bodies 832-33-34-35-821-31-30-L194-L195-932-33-34-35-21-31-30-L294-L295) .....	-	-	-	6	6
5504	Lockwasher 5/16 (Use with bodies 832-33-34-35-821-31-30-L194-L195-932-33-34-35-21-31-30-L294-L295) .	-	-	-	6	6
7005	Nut 5/16-24 (Use with bodies 832-33-34-35-821-31-30-L194-L195-932-33-34-35-21-31-30-L294-L295) .....	-	-	-	6	6
225998	Gasoline tank to frame bracket rear right (Use with bodies 830-21-31-930-21-31) .....	-	-	-	1	1
225999	Gasoline tank to frame bracket rear left (Use with bodies 830-21-31-930-21-31) .....	-	-	-	1	1
225528	Gasoline tank to frame rear channel bracket upper (Use on bodies 836-37-38-827-839-873-936-37-38-27-73-39) ..	-	-	-	2	2
225529	Gasoline tank to frame rear channel bracket lower (Use on bodies 836-37-38-827-839-73-936-37-38-27-39-73) ...	-	-	-	2	2
6039	Screw 5/16-24 x 11/16 hex. hd. (Use on bodies 836-37-38-827-839-873-936-37-38-27-39-73) .....	-	-	-	4	4
5504	Lockwasher 5/16 (Use on bodies 836-37-38-827-39-73-936-37-38-27-39-73) .....	-	-	-	4	4
7005	Nut 5/16-24 (Use with bodies 836-37-38-827-39-73-936-37-38-27-39-73) .....	-	-	-	4	4
223226	Gasoline tank to frame rear intermediate channel bracket upper (Used on bodies 832-33-34-35-36-37-38-39-27-73-L194-L195-932-33-34-35-36-37-38-39-27-73-L294-L295) ..	-	-	-	1	1
223225	Gasoline tank to frame rear intermediate channel bracket lower (Used on bodies 832-33-34-35-36-37-38-39-27-73-L194-L195-932-33-34-35-36-37-38-39-27-73-L294-L295) ..	-	-	-	1	1
225993	Gasoline tank to frame rear intermediate channel bracket upper (Use with bodies 830-21-31-921-31-30) .....	-	-	-	1	1
225994	Gasoline tank to frame rear intermediate channel bracket lower (Use with bodies 830-21-31-921-31-30) .....	-	-	-	1	1
7809	Bolt 5/16-24 x 7/8 hex. hd. ....	-	-	-	2	2
5504	Lockwasher 5/16" .....	-	-	-	2	2
7005	Nut 5/16-24 .....	-	-	-	2	2
223826	Gasoline tank gauge assembly (Use with bodies 832-33-34-35-821-31-30-L194-L195-932-33-34-35-21-31-30-L294-L295) .....	-	-	-	1	1
225619	Gasoline tank gauge assembly (Use with bodies 836-37-38-827-39-73-932-33-34-35-21-30-L294-L295) .....	-	-	-	1	1
5569	Screw No. 10-32 x 1/2" fill. hd. ....	-	-	-	5	5
7003	Binding post nut .....	-	-	-	1	1
5935	Lockwasher No. 10 (Shakeproof) .....	-	-	-	1	1
223843	Gasoline tank gauge gasket .....	-	-	-	1	1
230438	Gasoline tank inlet cap assembly .....	-	-	-	1	1
228814	Gasoline tank inlet cover assembly (Supersedes 190845) .	-	-	-	1	-
228938	Gasoline tank inlet cover gasket (Supersedes 190847) ...	-	-	-	1	-
223241	Gasoline tank inlet to fender screw .....	-	-	-	3	3

Piece No.	Name	No. Required				
		905 906	1005 1006	1107 1108	1207 1208	1407 1408
5500	Lockwasher No. 10 .....	-	-	-	3	3
225493	Gasoline tank inlet flange gasket (Use with bodies 821-831-32-33-34-35-830-L194-L195-921-31-32-33-34-35-L294-L295-930) .....	-	-	-	1	1
228602	Gasoline tank inlet tube assembly (Use with bodies 836-37-38-827-39-73-936-37-38-27-39-73) .....	-	-	-	1	1
228581	Gasoline tank inlet tube assembly (Use with bodies 832-33-34-35-L194-L194-932-33-34-35-L294-L295) (Supersedes 223235) .....	-	-	-	1	1
228593	Gasoline tank inlet tube assembly (Use with bodies 830-21-31-930-21-31) (Supersedes 223235) .....	-	-	-	1	1
225493	Gasoline tank inlet tube elbow gasket (Use with bodies 836-7-8-9-27-73-936-37-38-39-27-73) .....	-	-	-	1	1
7824	Gasoline tank inlet tube flange screw 1/4-28 x 5/8" hex. hd. ....	-	-	-	8	8
5502	Lockwasher 1/4" .....	-	-	-	8	8
223223	Gasoline tank inlet tube flange gasket .....	-	-	-	1	1
223231	Gasoline tank inlet tube to wheel compartment bottom grommet (Use with bodies 836-37-38-827-39-873-936-37-38-27-39-73) .....	-	-	-	1	1
225949	Screw No. 6 x 1/2 Parker Kalon (Use with bodies 836-37-38-827-39-873-936-37-38-27-39-73) .....	-	-	-	8	8
6387	Washer-plain (Use with bodies 836-37-38-827-39-873) ..	-	-	-	8	-
226725	Gasoline tank inlet tube to wheel compartment bottom grommet retainer-inner (Use with bodies 836-7-8-827-39-73-936-37-38-39-27-73) .....	-	-	-	1	1
225724	Gasoline tank inlet tube to wheel compartment bottom grommet retainer-outer (Use with bodies 836-7-8-827-39-73-936-37-38-927-39-73) .....	-	-	-	1	1
223231	Gasoline tank inlet tube to wheel housing grommet .....	-	-	-	1	1
225949	Gasoline tank inlet tube to wheel housing grommet screw No. 6 x 1/2 Parker Kalon .....	-	-	-	8	8
6387	Washer-plain .....	-	-	-	8	3
225533	Gasoline tank support bracket (Use with bodies 836-37-38-827-39-873-936-37-38-27-39-73) .....	-	-	-	3	1
223212	Gasoline tank support bracket front (Use with bodies 832-33-34-35-821-31-30-L194-L195-932-33-34-35-21-31-30-L294-L295) .....	-	-	-	1	1
4212	Rivet 1/8 x 1/2 (Use with bodies 832-33-34-35-821-31-30-L194-L195-932-33-34-35-21-30-L294-L295) .....	-	-	-	8	8
4212	Rivet 1/8 x 1/2 (Use with bodies 836-37-38-827-39-73-936-37-38-27-39-73) .....	-	-	-	24	24
223222	Gasoline tank support bracket rear (Use with bodies 832-33-34-35-821-31-30-L194-L195-932-33-34-35-21-31-30-L294-L295) .....	-	-	-	2	2
4212	Rivet 1/8 x 1/2 (Use with bodies 832-33-34-35-821-31-30-L194-L195-932-33-34-35-21-31-30-L294-L295) .....	-	-	-	16	16
114141	Gasoline tank support bracket screw .....	-	-	-	3	3
5071	Washer 7/16" special .....	-	-	-	2	2
7007	Nut 7/16-20 .....	-	-	-	3	3
120813	Lockwire 5" long .....	-	-	-	3	3
225634	Gasoline tube assembly (Use on 1207-1407) .....	-	-	-	1	1
225635	Gasoline tube assembly (Use on 1208-1408) .....	-	-	-	1	1
105161	Gasoline tube assembly clip .....	-	-	-	1	1
209173	Gasoline tube assembly clip .....	-	-	-	1	1
79005	Gasoline tube assembly clip .....	-	-	-	6	6
5835	Screw No. 10-32 x 3/4" fill. head .....	-	-	-	6	6
5049	Washer 3/8" special .....	-	-	-	1	1
5500	Lockwasher No. 10 .....	-	-	-	6	6

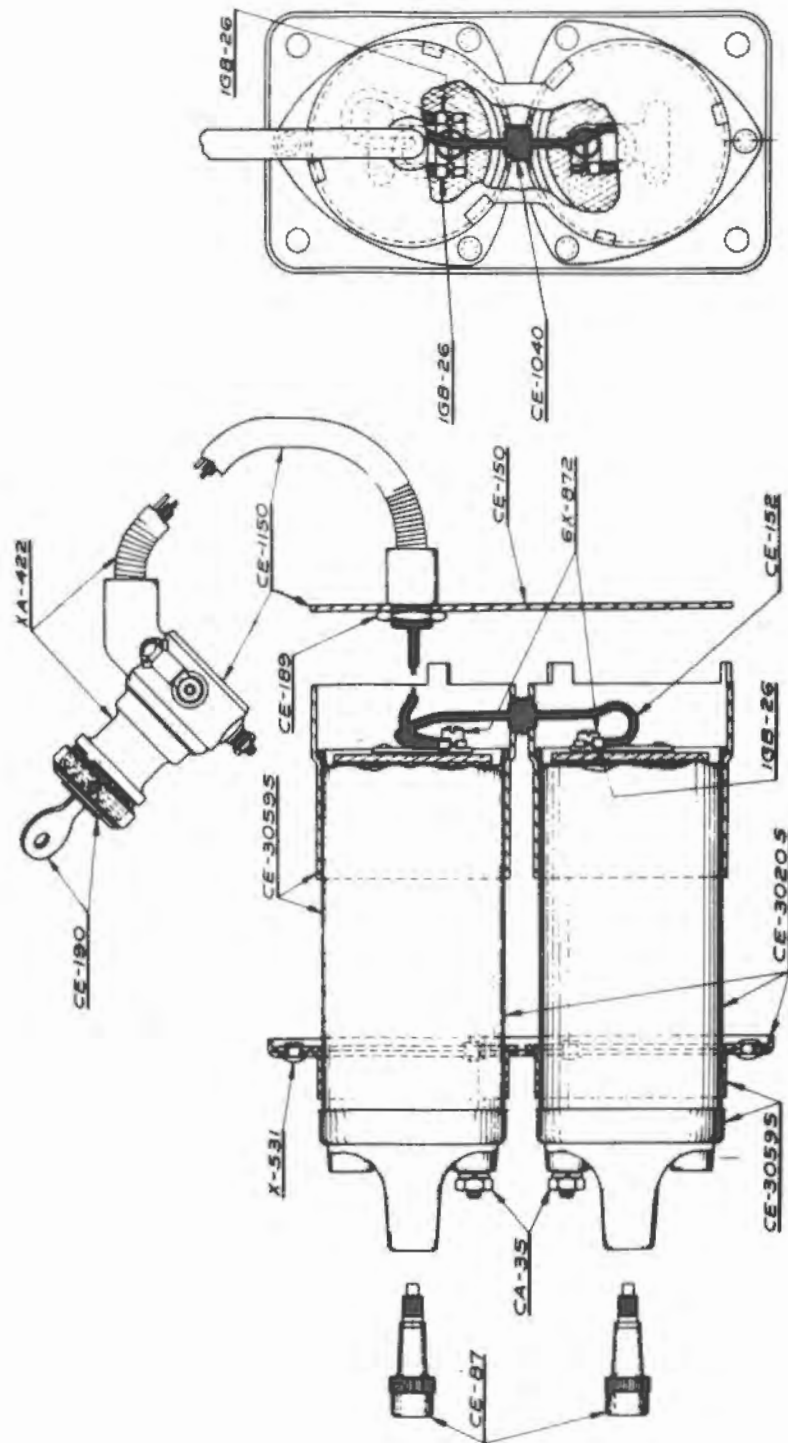

905-6-1005-6



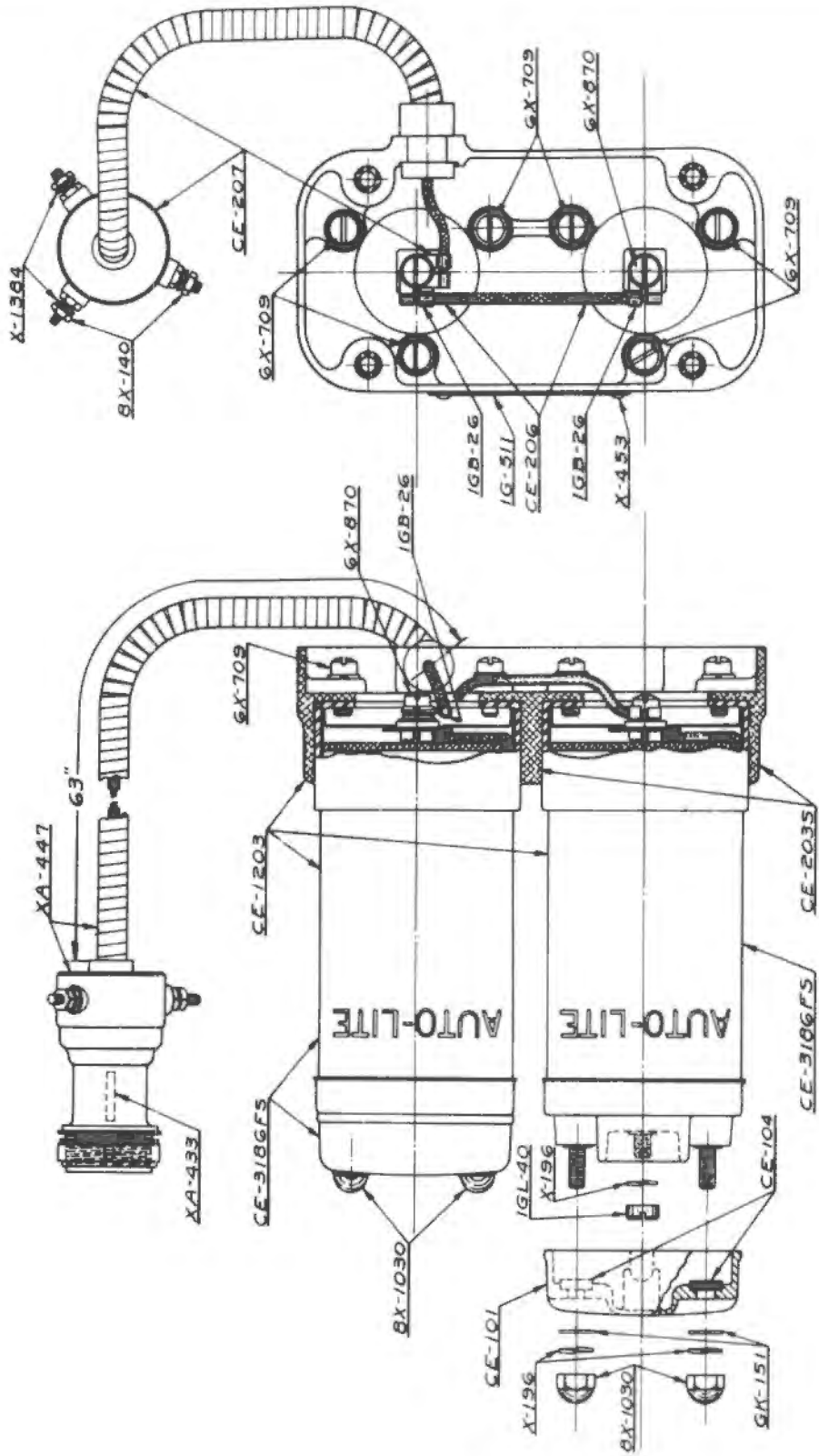

1107-1108

Piece No.	Name	No. Required				
		905 906	1005 1006	1107 1108	1207 1208	1407 1408
3874	Washer 5/16" .....	-	-	-	2	2
7003	Nut No. 10-32 .....	-	-	-	6	6
5468	Gasoline tube assembly union nut 3/8 .....	-	-	-	1	1
225642	Gasoline tube connection-front .....	-	-	-	1	1
216655	Gasoline tube to frame shield .....	-	-	-	1	1
6352	Screw No. 14 x 5/8 binding head (Parker Kalon) .....	-	-	-	2	2
225678	Gasoline tube insulator-front .....	-	-	-	1	1
225746	Gasoline tube insulator-rear .....	-	-	-	1	1

## IGNITION COIL AND SWITCH

(Electric Auto-Lite No. CE-4020)

The following parts are listed with the manufacturers' piece numbers and are to be ordered by these numbers. Dealers should order these parts through their distributor.

CA-35	Nut No. 10-32 .....	2	2	-	-	-
CE-87	Secondary screw terminal .....	2	2	-	-	-
CE-152	Lead assembly .....	1	1	-	-	-
IGB-26	Terminal .....	1	1	-	-	-
CE-1150	Lock and plate assembly .....	1	1	-	-	-
CE-1150-A	Lock and plate assembly (Use with steering gear 1-21/32" longer than standard) .....	-	1	-	-	-
CE-150	Lock plate .....	1	1	-	-	-
IGB-26	Terminal .....	1	1	-	-	-
XA-422	Lock assembly .....	1	1	-	-	-
CE-189	Nut .....	1	1	-	-	-
CE-190	Nut plug with key .....	1	1	-	-	-
CE-3020S	Coils and mtg. plate assembly .....	1	1	-	-	-
CE-1040	Insulating bushing .....	1	1	-	-	-
CE-3059S	Coil and case assembly .....	2	2	-	-	-
X-531	Rivet tubular 3/16 x 7/32" .....	6	6	-	-	-
IGB-26	Terminal .....	1	1	-	-	-
X-196	Lockwasher No. 10 .....	4	4	-	-	-
6X-872	Screw No. 10-32 x 1/4" fill. hd. ....	2	2	-	-	-

## IGNITION COIL AND SWITCH

(Electric Auto-Lite No. CE-4022)

The following parts are listed with the manufacturers' piece numbers and are to be ordered by these numbers. Dealers should order these parts through their distributor.

CE-207	Lock cable assembly-compartment .....	-	-	1	-	-
IGB-26	Terminal .....	-	-	1	-	-
XA-447	Lock cable assembly .....	-	-	1	-	-
XA-433	Lock cylinder adopter spring .....	-	-	1	-	-
8X-140	Nc. 6-32 hex. nut .....	-	-	3	-	-
X-1384	Nc. 6-Shakeproof washer .....	-	-	3	-	-
CE-1203	Coils and bracket assembly .....	-	-	1	1	1
CE-203S	Coil bracket .....	-	-	1	1	1
CE-206	Jumper lead assembly .....	-	-	1	1	1
IGB-26	Terminal .....	-	-	2	2	2
CE-3186FS	Ignition coil part assembly .....	-	-	2	2	2
CE-101	Coil cover .....	-	-	1	1	1

Piece No.	Name	No. Required				
		905 906	1005 1006	1107 1108	1207 1208	1407 1408
CE-104	Rubber gasket .....	-	-	2	2	2
GK-151	Plain steel washer .....	-	-	2	2	2
IGL-40	No. 10-32 Nut .....	-	-	1	1	1
X-196	No. 10 Lockwasher .....	-	-	3	4	4
8X-1030	No. 10-32 Cap nut .....	-	-	2	2	2
IG-511	Name plate .....	-	-	1	1	1
X-196	No. 10 Lockwasher .....	-	-	8	6	6
X453	No. 2 x 3/16 Drive screw .....	-	-	2	2	2
6X-709	No. 10-32 x 7/16 fill. head screw .....	-	-	6	6	6
6X-870	No. 10-32 x 5/16 fill. head screw .....	-	-	2	2	2

## INSTRUMENT BOARD

207324	Instrument board plate and instruments assembly (Prior frame 901201) .....	-	1	-	-	-
210237	Instrument board plate and instruments assembly (After frame 901200) .....	-	1	-	-	-
201229	Instrument board plate and instruments assembly .....	1	-	-	-	-
201225	Instrument board assembly (Closed bodies) .....	1	-	-	-	-
199742	Instrument board assembly (Open bodies) .....	1	-	-	-	-
206076	Instrument board assembly (Used on bodies 633-4-5-6-7-8) .....	-	1	-	-	-
206078	Instrument board assembly (Used on body 639) .....	-	1	-	-	-
204661	Instrument board assembly (Used on bodies 630-1-641) ...	-	1	-	-	-
212783	Instrument board assembly (Used on 732-3-4-5-6-7) .....	-	-	1	-	-
212786	Instrument board assembly (Used on 738-739) .....	-	-	1	-	-
212760	Instrument board assembly (Used on 730-31-741) (Specify finish-Butt Walnut or Carpathian Elm Burl) .....	-	-	1	-	-
201208	Instrument board ammeter .....	1	-	-	-	-
213832	Instrument board ammeter .....	-	-	1	-	-
210155	Instrument board ammeter (After frame 901200) .....	-	1	-	-	-
209034	Instrument board ammeter (Prior to frame 901201) .....	-	1	-	-	-
205828	Instrument board ammeter gasket (Supersedes 201203) ....	1	1	1	-	-
202695	Instrument board ammeter glass .....	1	1	1	-	-
209909	Instrument board brake vacuum control valve lever .....	-	1	1	-	-
5310	Screw No. 8-32 round head .....	-	1	1	-	-
5435	Washer .....	-	1	1	-	-
5861	Lockwasher .....	-	1	1	-	-
209908	Instrument board brake vacuum control valve lever base .	-	1	1	-	-
21818	Washer .....	-	1	1	-	-
6321	Nut 5/8-18 special .....	-	1	1	-	-
209903	Instrument board brake vacuum control valve lever universal joint flange .....	-	1	1	-	-
209919	Instrument board brake vacuum control valve stop plate .	-	1	1	-	-
209918	Instrument board brake vacuum control valve stop plate spring .....	-	1	1	-	-
209925	Instrument board brake vacuum control valve universal joint drive shaft .....	-	1	1	-	-
209940	Instrument board brake vacuum control valve universal joint flange .....	-	2	2	-	-
5429	Screw No. 8-32 x 13/32" fill. head .....	-	4	4	-	-
3866	Washer .....	-	4	4	-	-
5500	Lockwasher No. 10 .....	-	4	4	-	-
7003	Nut No. 8-32 plain .....	-	4	4	-	-
209907	Instrument board brake vacuum control valve universal joint flange and hub assembly set screw .....	-	2	2	-	-
210126	Instrument board brake vacuum control valve universal joint flange hub and disc assembly .....	-	2	2	-	-
197488	Instrument board cigar lighter assembly .....	1	1	1	-	-

Piece No.	Name	No. Required				
		905 906	1005 1006	1107 1108	1207 1208	1407 1408
182377	Instrument board cigar lighter tip .....	1	1	1	-	-
190650	Instrument board cigar lighter tip and knob assembly ...	1	1	1	-	-
201200	Instrument board clock (Jaeger type) .....	1	1	-	-	-
213840	Instrument board clock (Jaeger type) .....	-	-	1	-	-
203141	Instrument board clock clamp .....	1	1	-	-	-
213856	Instrument board clock clamp .....	-	-	2	-	-
215049	Instrument board clock clamp stud .....	-	-	2	-	-
6056	Lockwasher 3/16" .....	-	-	2	-	-
197496	Wing nut .....	-	-	2	-	-
5895	Screw 1/4-28 x 11/16" fill. head .....	2	2	-	-	-
5502	Lockwasher 1/4" .....	2	2	-	-	-
205829	Instrument board clock gasket (Supersedes 190048) .....	1	1	1	-	-
202696	Instrument board clock glass .....	1	1	1	-	-
193866	Instrument board compartment door frame assembly right (Open bodies) .....	1	1	-	-	-
184757	Instrument board compartment door frame assembly right (Open bodies) .....	-	-	1	-	-
193867	Instrument board compartment door frame assembly left (Open bodies) .....	1	1	-	-	-
184758	Instrument board compartment door frame assembly left (Open bodies) .....	-	-	1	-	-
187936	Instrument board compartment door frame assembly right (Closed bodies) .....	1	1	-	-	-
184698	Instrument board compartment door frame assembly right (Closed bodies) .....	-	-	1	-	-
187935	Instrument board compartment door frame assembly left (Closed bodies) .....	1	1	-	-	-
184699	Instrument board compartment door frame assembly left (Closed bodies) .....	-	-	1	-	-
5724	Screw No. 8-32 x 3/8" oval head .....	4	4	4	-	-
5860	Washer No. 8 countersunk (Shakeproof) .....	4	4	4	-	-
185893	Instrument board compartment door anti-rattler .....	2	2	2	-	-
180307	Instrument board compartment door hinge assembly .....	2	2	2	-	-
5859	Rivet 3/16 x 5/16" tubular round head .....	4	4	4	-	-
187495	Instrument board compartment door knob .....	2	2	2	-	-
5569	Screw No. 10-32 x 1/2" fill. head machine .....	2	1	1	-	-
5500	Lockwasher No. 10 .....	2	2	2	-	-
5966	Screw No. 10-32 x 7/8" fill. head machine .....	-	1	1	-	-
184761	Instrument board compartment door panel assembly right (Open bodies) .....	1	1	-	-	-
214894	Instrument board compartment door panel assembly right (Open bodies) (Specify finish - Burl Walnut or Carpathian Elm Burl) .....	-	-	1	-	-
184762	Instrument board compartment door panel assembly left (Open bodies) .....	1	1	-	-	-
214895	Instrument board compartment door panel assembly left (Open bodies) (Specify finish - Burl Walnut or Carpathian Elm Burl) .....	-	-	1	-	-
184753	Instrument board compartment door panel assembly right (Closed bodies) .....	1	-	-	-	-
184754	Instrument board compartment door panel assembly left (Closed bodies) .....	1	-	-	-	-
206080	Instrument board compartment door panel assembly right (Closed bodies) .....	-	1	1	-	-
206081	Instrument board compartment door panel assembly left (Closed bodies) .....	-	1	1	-	-
105029	Instrument board compartment door spring dowel .....	2	2	2	-	-
180301	Instrument board compartment door striker plate .....	2	2	2	-	-
141649	Rivet 3/16 x 1/4" round head tubular .....	4	4	4	-	-
203137	Instrument board cover assembly left .....	1	-	-	-	-

Piece No.	Name	No. Required				
		905 906	1003 1006	1107 1108	1207 1208	1407 1408
213845	Instrument board cover assembly left .....	-	-	1	-	-
210170	Instrument board cover assembly left (After frame 901200) .....	-	1	-	-	-
203138	Instrument board cover assembly right .....	1	-	-	-	-
213851	Instrument board cover assembly right .....	-	-	1	-	-
203137	Instrument board cover assembly left (Prior to frame 901201) .....	-	1	-	-	-
203138	Instrument board cover assembly right (Prior to frame 901201) .....	-	1	-	-	-
203140	Instrument board cover assembly center (Prior to frame 901201) .....	-	1	-	-	-
210172	Instrument board cover assembly right (After frame 901200) .....	-	1	-	-	-
203140	Instrument board cover assembly center .....	1	-	-	-	-
213843	Instrument board cover assembly center .....	-	-	1	-	-
210174	Instrument board cover assembly center (After frame 901200) .....	-	1	-	-	-
216288	Instrument board cover - center - light seal .....	-	-	1	-	-
203180	Instrument board cover stud .....	2	2	-	-	-
215049	Instrument board cover stud .....	-	-	3	-	-
6056	Lockwasher 3/16" .....	2	2	3	-	-
197496	Nut .....	-	-	3	-	-
197962	Instrument board cover retaining spring .....	1	1	-	-	-
101200	Instrument board cover retaining spring washer 13/64 x 5/8" .....	1	1	-	-	-
197496	Instrument board cover wing nut .....	2	2	-	-	-
203958	Instrument board finishing plate assembly .....	1	-	-	-	-
207807	Instrument board finishing plate assembly .....	-	1	-	-	-
213853	Instrument board finishing plate assembly .....	-	-	1	-	-
203996	Instrument board finishing plate gasket .....	1	1	-	-	-
213871	Instrument board finishing plate gasket .....	-	-	1	-	-
190391	Instrument board finishing plate attaching lug spring ..	5	5	5	-	-
213870	Instrument board finishing plate attaching lug washer ..	-	-	8	-	-
3867	Washer (inner) plain .....	5	5	-	-	-
3866	Washer (outer) plain .....	5	5	8	-	-
190045	Lock .....	5	5	8	-	-
201195	Instrument board gasoline or oil gauge .....	1	-	-	-	-
213836	Instrument board gasoline or oil gauge .....	-	-	1	-	-
210272	Instrument board gasoline or oil gauge (Prior to frame 901201) .....	-	1	-	-	-
210159	Instrument board gasoline or oil gauge (After frame 901200) .....	-	1	-	-	-
205827	Instrument board gasoline or oil gauge gasket (Supersedes 201204) .....	1	1	-	-	-
205828	Instrument board gasoline or oil gauge gasket .....	-	-	1	-	-
202695	Instrument board gasoline or oil gauge glass .....	1	-	-	-	-
213326	Instrument board gasoline or oil gauge glass .....	-	1	1	-	-
197492	Instrument board gasoline or oil gauge switch .....	1	1	1	-	-
197493	Screw No. 6 x 1/4" oval head machine .....	2	2	2	-	-
48157	Washer 3/16 x 7/16" countersunk .....	2	2	2	-	-
203199	Instrument board ignition coil grommet .....	1	1	-	-	-
215393	Instrument board ignition coil cable conduit cylinder head clip .....	-	-	2	-	-
215392	Instrument board ignition coil cable conduit cylinder head water outlet flange clip .....	-	-	1	-	-
207828	Instrument board ignition coil dash grommet .....	-	-	1	-	-
207829	Instrument board ignition coil dash grommet retainer ...	-	-	1	-	-
5984	Screw No. 6 x 3/8 round head Parker Kalon .....	-	-	3	-	-
215384	Instrument board ignition coil assembly (With key) .....	-	-	1	-	-
202908	Instrument board ignition coil and switch assembly (With key) .....	1	-	-	-	-

## SERVICE PARTS LIST—PACKARD TWELVE

Instrument Board 67

Piece No.	Name	No. Required				
		905 906	1005 1006	1107 1108	1207 1208	1407 1408
209099	Instrument board ignition coil and switch assembly (With key) .....	-	1	-	-	-
6402	Screw 1/4-20 x 3/4" hex. hd. ....	-	-	4	-	-
5502	Lockwasher 1/4" .....	-	-	4	-	-
3868	Washer 1/4" .....	-	-	4	-	-
5470	Screw 1/4-28 x 3/4" hex. hd. ....	4	4	-	-	-
213213	Instrument board ignition coil cable clip (Used on bodies 630-1-9-641) .....	-	1	-	-	-
5502	Lockwasher 1/4" .....	4	4	-	-	-
215385	Instrument board ignition coil bracket .....	-	-	1	-	-
215397	Instrument board ignition coil bracket to water pump body nut .....	-	-	1	-	-
215398	Washer 5/8" .....	-	-	1	-	-
6322	Lockwasher 5/8" .....	-	-	1	-	-
215383	Instrument board ignition coil cable and switch assembly	-	-	1	-	-
156626	Instrument board ignition coil to distributor high tension cable terminal-male .....	-	-	1	-	-
156625	Instrument board ignition coil to distributor high tension cable terminal-female .....	-	-	1	-	-
216927	Instrument board ignition coil to distributor high tension cable insulator .....	-	-	2	-	-
33287	Instrument board ignition coil to distributor low tension cable terminal .....	-	-	4	-	-
36111	Insulator .....	-	-	4	-	-
210608	Instrument board ignition coil lock cylinder (Prior to Motor No. 902223) .....	-	-	1	-	-
219312	Instrument board ignition coil lock cylinder (After Motor No. 902222) .....	-	-	1	-	-
197966	Instrument board instrument clamp large .....	2	2	4	-	-
210175	Instrument board instrument clamp small .....	2	2	-	-	-
197968	Stud No. 10-32 x 1-3/4" .....	4	4	-	-	-
213868	Stud .....	-	-	4	-	-
197496	Instrument board instrument clamp wing nut .....	4	4	4	-	-
6056	Lockwasher 3/16" .....	4	4	4	-	-
102590	Instrument board light bulb .....	3	3	3	-	-
102585	Instrument board light bulb-center .....	-	-	1	-	-
190042	Instrument board light (Indirect) socket retainer .....	3	3	3	-	-
197532	Instrument board light switch .....	1	1	1	-	-
202898	Instrument board light sockets and cable assembly- indirect .....	1	1	1	-	-
36111	Insulator .....	1	1	1	-	-
187295	Instrument board light-direct (Reading light) .....	1	-	-	-	-
126578	Instrument board light-direct (Reading light) .....	-	1	1	-	-
128827	Instrument board light base-direct .....	1	1	1	-	-
195904	Instrument board light cover-direct .....	1	-	-	-	-
128828	Instrument board light cover-direct .....	-	1	1	-	-
7916	Instrument board light screw .....	2	-	-	-	-
6291	Instrument board light screw .....	-	2	2	-	-
7002	Instrument board light screw nut .....	2	2	2	-	-
3774	Lockwasher .....	2	2	2	-	-
102590	Instrument board light (Direct) bulb .....	1	1	-	-	-
201201	Instrument board motor thermometer (Prior to frame No. 901201) .....	1	1	-	-	-
210166	Instrument board motor thermometer (After frame No. 901200) .....	-	1	-	-	-
213839	Instrument board motor thermometer .....	-	-	1	-	-
202695	Instrument board motor thermometer glass .....	1	1	1	-	-
190046	Instrument board motor thermometer tube bushing .....	1	1	-	-	-
209131	Instrument board motor thermometer tube bushing-inner ..	-	1	-	-	-
205828	Instrument board motor thermometer gasket (Supersedes 201203) .....	1	1	1	-	-



Piece No.	Name	No. Required				
		905 906	1005 1006	1107 1108	1207 1208	1407 1408
201220	Instrument board oil pressure gauge (Prior to frame No. 901201) .....	1	1	-	-	-
210162	Instrument board oil pressure gauge (After frame No. 901200) .....	-	1	-	-	-
213830	Instrument board oil pressure gauge .....	-	-	1	-	-
205828	Instrument board oil pressure gauge gasket (Supersedes 201203) .....	1	1	1	-	-
202695	Instrument board oil pressure gauge glass .....	1	1	1	-	-
202578	Instrument board oil pressure gauge tube lower assembly.	1	-	-	-	-
207649	Instrument board oil pressure gauge tube lower assembly.	-	1	-	-	-
219203	Instrument board oil pressure gauge tube lower assembly.	-	-	1	-	-
194974	Instrument board oil pressure gauge tube lower assembly clip .....	1	1	1	-	-
5984	Screw No. 6 x 3/8" round head drive (Parker-Kalon) .	1	1	1	-	-
6300	Instrument board oil pressure gauge tube lower nut .....	-	-	1	-	-
215844	Instrument board oil pressure gauge tube lower connection adapter .....	-	-	1	-	-
215547	Instrument board oil pressure gauge tube lower hose asb.	-	-	1	-	-
202940	Instrument board oil pressure gauge tube upper assembly.	1	-	-	-	-
207697	Instrument board oil pressure gauge tube upper assembly.	-	1	1	-	-
157477	Union nut 1/4" .....	4	4	4	-	-
190923	Elbow .....	1	-	-	-	-
210070	Elbow .....	-	1	-	-	-
219165	Elbow .....	-	-	1	-	-
7007	Nut .....	1	1	1	-	-
3883	Washer 7/16" plain .....	1	1	1	-	-
5806	Lockwasher .....	1	1	1	-	-
194974	Clip-style No. 15-1/8" .....	1	1	1	-	-
5984	Screw No. 6-3/8" round head (Parker-Kalon) .....	1	1	1	-	-
216887	Instrument board oil pressure gauge tube lower anti-squeak .....	-	-	x	-	-
207806	Instrument board plate assembly (Prior to frame No. 901200) .....	-	1	-	-	-
203975	Instrument board plate assembly .....	1	-	-	-	-
213864	Instrument board plate assembly .....	-	-	1	-	-
210168	Instrument board plate assembly (After frame No. 901201)	-	1	-	-	-
190088	Instrument board plate screw .....	10	10	10	-	-
7003	Nut No. 10-32 plain .....	10	10	10	-	-
5818	Lockwasher 3/16" .....	10	10	10	-	-
119143	Screw boss 1/4-28 .....	4	4	-	-	-
182432	Screw boss No. 10-32 .....	6	6	-	-	-
213886	Instrument board radio hole cover assembly .....	-	-	1	-	-
213856	Instrument board radio hole cover assembly clamp .....	-	-	2	-	-
6056	Lockwasher .....	-	-	2	-	-
197496	wing nut .....	-	-	2	-	-
213872	Instrument board radio hole cover assembly clamp upper .	-	-	1	-	-
210834	Instrument board radio hole cover emblem .....	-	-	1	-	-
5447	Lockwasher 1/4" .....	-	-	1	-	-
215003	Instrument board radio hole cover gasket .....	-	-	1	-	-
201198	Instrument board speedometer (Waltham) (Kilometers per hour) .....	1	1	-	-	-
213826	Instrument board speedometer (Waltham) (Kilometers per hour) .....	-	-	1	-	-
201199	Instrument board speedometer (Waltham) (Miles per hour).	1	1	-	-	-
213825	Instrument board speedometer (Waltham) (Miles per hour).	-	-	1	-	-
205829	Gasket (Supersedes 190048) .....	1	1	1	-	-
215049	Instrument board speedometer stud .....	-	-	2	-	-
197496	Wing nut .....	-	-	2	-	-
5818	Lockwasher No. 10 Shakeproof .....	-	-	2	-	-

Piece No.	Name	No. Required				
		905 906	1005 1006	1107 1108	1207 1208	1407 1408
5896	Instrument board speedometer clamp screw 1/4-28 x 13/16" fill. head machine .....	2	2	-	-	-
5502	Lockwasher 1/4" .....	2	2	-	-	-
201735	Instrument board speedometer driving shaft (Waltham) ...	1	1	1	-	-
129773	Clip .....	1	-	-	-	-
209851	Clip .....	-	2	2	-	-
147406	Clip (Special) .....	1	-	-	-	-
213056	Clip .....	-	-	1	-	-
5812	Screw No. 10-32 x 5/8" fill. head .....	1	1	1	-	-
5500	Lockwasher 3/16" .....	1	1	1	-	-
202842	Instrument board speedometer driving shaft cable (Waltham) .....	1	1	1	-	-
190231	Instrument board speedometer driving shaft toe board bushing .....	1	-	1	-	-
202696	Instrument board speedometer glass .....	1	1	1	-	-
201511	Instrument board starter motor switch .....	1	-	-	-	-
207800	Instrument board starter motor switch .....	-	1	1	-	-
213340	Instrument board starter motor base .....	-	1	1	-	-
213338	Instrument board starter motor switch button .....	-	1	1	-	-
203901	Instrument board starter motor switch insulator .....	1	1	1	-	-
207803	Instrument board starter motor switch washer .....	-	1	-	-	-
210619	Instrument board starter motor switch washer .....	-	-	1	-	-
190674	Instrument board steering post bracket support .....	1	1	1	-	-
5764	Screw 1/4-28 x 3/4" O.H. machine .....	2	2	2	-	-
5471	Screw 1/4-28 x 5/8" hex. hd. ....	2	2	2	-	-
3868	Washer 1/4" .....	2	2	2	-	-
5502	Lockwasher 1/4" .....	4	4	4	-	-
7004	Nut 1/4-28 .....	2	2	2	-	-
187416	Instrument board steering post bracket support liner ...	1	1	1	-	-
203930	Instrument board throttle control cable assembly .....	1	-	-	-	-
202485	Instrument board throttle control cable dash clamp asb..	1	-	-	-	-
5470	Screw 1/4-28 x 3/4" hex. hd. ....	2	-	-	-	-
5502	Lockwasher 1/4" .....	2	-	-	-	-
5576	Instrument board throttle control cable dash clamp clamping screw No. 10-32 x 5/8" fill. head .....	1	-	-	-	-
5500	Lockwasher No. 10 .....	1	-	-	-	-
190616	Instrument board throttle control cable knob .....	1	-	-	-	-

## INSTRUMENT BOARD

228505	Instrument board ammeter .....	-	-	-	1	1
3939	Instrument board ammeter terminal washer .....	-	-	-	2	2
5500	Lockwasher 3/16" .....	-	-	-	2	2
5416	Nut No. 10-32 hex. hd. ....	-	-	-	2	2
224621	Instrument board assembly .....	-	-	-	1	1
229428	Instrument board assembly (Used with body 839-939) .....	-	-	-	1	1
6039	Screw 5/16-24 x 11/16 hex. hd. ....	-	-	-	4	4
3874	Washer 5/16" plain .....	-	-	-	4	4
5504	Lockwasher 5/16" .....	-	-	-	4	4
197488	Instrument board cigar lighter assembly .....	-	-	-	1	1
182377	Instrument board cigar lighter tip .....	-	-	-	1	1
190650	Instrument board cigar lighter tip and knob assembly ...	-	-	-	1	1
223921	Instrument board clock .....	-	-	-	1	1
228646	Instrument board clock dial .....	-	-	-	1	1
225007	Instrument board clock gasket .....	-	-	-	1	1
5310	Instrument board clock screw No. 8-32 x 1/4 round head .	-	-	-	3	3
6472	Lockwasher No. 8 Shakeproof .....	-	-	-	3	3
230060	Instrument board clock and speedometer glass .....	-	-	-	1	1
195680	Instrument board compartment to dash panel bracket .....	-	-	-	2	2
5317	Screw 1/4-28 x 1-1/8 hex. hd. ....	-	-	-	2	-

Piece No.	Name	No. Required				
		901 906	1003 1006	1107 1108	1207 1208	1407 1408
7842	Screw 1/4-28 x 1-1/4 hex. hd. ....	-	-	-	-	2
5667	Screw No. 10-32 x 5/8 round head .....	-	-	-	2	2
5502	Lockwasher 1/4" .....	-	-	-	2	2
5500	Lockwasher 3/16" .....	-	-	-	2	2
3867	Washer 3/16" .....	-	-	-	4	4
7003	Nut No. 10-32 .....	-	-	-	2	2
220873	Instrument board compartment door dowel assembly .....	-	-	-	2	2
127858	Rivet .....	-	-	-	4	-
6489	Rivet 1/8 x 13/64 oval hd. tubular .....	-	-	-	-	4
220874	Instrument board compartment door dowel spring .....	-	-	-	2	4
224116	Instrument board compartment door frame assembly-right ..	-	-	-	1	1
224117	Instrument board compartment door frame assembly-left ..	-	-	-	1	1
226083	Instrument board compartment door hinge assembly-left ..	-	-	-	1	1
220750	Instrument board compartment door hinge assembly-right ..	-	-	-	1	1
5619	Screw No. 8-32 x 5/16 flat head .....	-	-	-	4	4
5601	Screw No. 10-32 x 3/8 round head .....	-	-	-	4	4
7003	Nut No. 10-32 .....	-	-	-	4	4
5500	Lockwasher No. 10 .....	-	-	-	4	4
220865	Instrument board compartment door knob .....	-	-	-	1	1
5569	Screw No. 10-32 x 1/2 fill. head .....	-	-	-	1	1
5500	Lockwasher 3/16" .....	-	-	-	1	1
220878	Instrument board compartment door knob (Cylinder locking type) .....	-	-	-	1	1
226361	washer 3/4 plain special .....	-	-	-	1	1
220879	Nut 3/4-28 special .....	-	-	-	1	1
229255	Instrument board compartment door knob lock key .....	-	-	-	2	2
226080	Instrument board compartment door panel assembly-right ..	-	-	-	1	1
226081	Instrument board compartment door panel assembly-left ..	-	-	-	1	1
5254	Screw No. 8-32 x 5/16 oval head .....	-	-	-	8	-
6594	Screw No. 8-32 x 5/16 oval head .....	-	-	-	-	8
5860	Lockwasher No. 8 countersunk .....	-	-	-	8	8
228503	Instrument board gas gauge .....	-	-	-	1	-
230104	Instrument board gas gauge .....	-	-	-	-	1
223784	Instrument board gasoline or oil gauge switch .....	-	-	-	1	-
3939	Instrument board gasoline or oil gauge terminal washer ..	-	-	-	2	-
5500	Lockwasher 3/16" .....	-	-	-	2	-
5416	Nut No. 10-32 hex. hd. ....	-	-	-	2	-
228509	Instrument board gauge glass .....	-	-	-	2	2
228510	Instrument board gauge glass gasket .....	-	-	-	2	2
0234858	Instrument board gauge mask (Park and city) .....	-	-	-	-	1
0234891	Instrument board gauge mask (Drive and passenger) .....	-	-	-	-	1
225600	Instrument board light shield and socket assembled .....	-	-	-	2	2
225601	Instrument board light wire and socket assembled .....	-	-	-	1	1
215384	Instrument board ignition coil assembly .....	-	-	-	1	1
221000	Instrument board ignition coil assembly screw 1/4-20 x 5/8 hex. hd. ....	-	-	-	4	4
5502	Lockwasher 1/4" .....	-	-	-	4	4
219954	Instrument board ignition coil bracket .....	-	-	-	1	1
221002	Instrument board ignition coil bracket stud .....	-	-	-	2	2
7005	Nut 5/16-24 .....	-	-	-	2	2
5504	Lockwasher 5/16" .....	-	-	-	2	2
209858	Instrument board ignition coil to distributor high tension cable assembly .....	-	-	-	2	2
156626	Terminal-male .....	-	-	-	4	4
156625	Terminal-female .....	-	-	-	4	4
216927	Terminal insulator .....	-	-	-	2	2
209027	Instrument board ignition coil to distributor low tension cable assembly .....	-	-	-	2	2
33287	Terminal .....	-	-	-	4	4
36111	Terminal insulator .....	-	-	-	4	4

## SERVICE PARTS LIST—PACKARD TWELVE

Instrument Board 71

Piece No.	Name	No. Required				
		905 906	1005 1006	1107 1108	1207 1208	1407 1408
223659	Instrument board ignition switch and cable assembly ....	-	-	-	1	1
221061	Instrument board ignition switch cable cylinder head clip .....	-	-	-	2	2
221409	Instrument board ignition switch cable cylinder head water outlet flange clip .....	-	-	-	1	1
207828	Instrument board ignition cable dash grommet .....	-	-	-	1	1
207829	Instrument board ignition cable dash grommet retainer ..	-	-	-	1	1
5984	Instrument board ignition cable dash grommet retainer screw No. 6 x 3/8 round head .....	-	-	-	3	3
219312	Instrument board ignition switch lock cylinder .....	-	-	-	1	1
228788	Instrument board ignition switch nut (Supersedes 225819)	-	-	-	1	1
228787	Instrument board ignition switch retainer (Supersedes 225820) .....	-	-	-	1	1
228504	Instrument board oil pressure gauge .....	-	-	-	1	1
225252	Instrument board oil pressure gauge tube lower assembly.	-	-	-	1	1
225253	Instrument board oil pressure gauge tube upper assembly.	-	-	-	1	1
157477	Instrument board oil pressure gauge tube assembly union nut 1/4 tube .....	-	-	-	3	3
216887	Instrument board oil pressure gauge tube lower anti- squeak .....	-	-	-	x	x
194974	Instrument board oil pressure gauge tube lower assembly clip style No. 15 .....	-	-	-	1	1
70128	Clip (Style No. 4 x 1/4) .....	-	-	-	2	2
5984	Screw No. 6 x 3/8 round head (Parker Kalon) .....	-	-	-	1	1
5504	Lockwasher 5/16" .....	-	-	-	2	2
7005	Nut 5/16-24 .....	-	-	-	2	2
225250	Instrument board oil pressure gauge tube lower assembly connector .....	-	-	-	1	1
215844	Instrument board oil pressure gauge tube lower connector adapter .....	-	-	-	1	1
225454	Instrument board oil pressure gauge tube lower connector adapter .....	-	-	-	1	1
225454	Instrument board oil pressure gauge tube upper connector adapter .....	-	-	-	2	2
219165	Instrument board oil pressure gauge tube elbow .....	-	-	-	1	1
7007	Nut .....	-	-	-	1	1
3883	Washer 7/16" .....	-	-	-	1	1
5806	Lockwasher 7/16" Shakeproof .....	-	-	-	1	1
215547	Instrument board oil pressure gauge tube lower hose asb.	-	-	-	1	1
6300	Instrument board oil pressure gauge tube lower nut (1/4 flared tube inverted weatherhead) .....	-	-	-	1	1
230086	Instrument board panel assembly (Supersedes 223707) ....	-	-	-	1	1
7003	Nut No. 10-32 .....	-	-	-	4	4
6056	Lockwasher No. 10 Shakeproof .....	-	-	-	2	2
5818	Lockwasher No. 10 Shakeproof .....	-	-	-	2	2
223922	Instrument board panel light switch assembly .....	-	-	-	1	1
225190	Screw No. 8-32 x 5/16 .....	-	-	-	2	2
5861	Lockwasher No. 8 Shakeproof .....	-	-	-	2	2
102590	Instrument board panel light bulb .....	-	-	-	4	4
228511	Instrument board panel mounting plate and face assembled	-	-	-	1	1
223950	Instrument board radio hole cover assembly .....	-	-	-	1	1
223940	Instrument board radio hole cover finishing plate .....	-	-	-	1	1
223933	Instrument board radio hole cover finishing plate emblem	-	-	-	1	1
225183	Instrument board radio hole cover finishing plate gasket	-	-	-	1	1
225005	Instrument board radio hole cover gasket .....	-	-	-	1	1
7003	Instrument board radio hole cover nut No. 10-32 .....	-	-	-	2	2
6056	Lockwasher No. 10 Shakeproof .....	-	-	-	2	2
102590	Instrument board reading light bulb .....	-	-	-	1	1
223789	Instrument board reading light housing assembly .....	-	-	-	1	1

Piece No.	Name	No. Required				
		905 906	1005 1006	1107 1108	1207 1208	1407 1408
225190	Instrument board reading light housing screw (No. 8-32 x 5/16) .....	-	-	-	2	2
7002	Nut No. 8-32 .....	-	-	-	2	2
6472	Lockwasher No. 8 Shakeproof .....	-	-	-	2	2
225151	Instrument board reading light socket assembly .....	-	-	-	1	1
36111	Instrument board reading light socket and cable assembly insulator .....	-	-	-	1	1
182459	Instrument board reading light switch assembly .....	-	-	-	1	1
223889	Instrument board signal light bulb single contact Mazda No. 51 - G-3-1/2-7V .....	-	-	-	4	4
223920	Instrument board speedometer (Miles per hour) .....	-	-	-	1	1
225156	Instrument board speedometer (Kilometers per hour) .....	-	-	-	1	1
230060	Instrument board speedometer and clock glass .....	-	-	-	1	1
210797	Instrument board speedometer driving shaft (69-33/64" overall) .....	-	-	-	1	-
225896	Instrument board speedometer driving shaft (75-33/64" overall) .....	-	-	-	1	1
205708	Instrument board speedometer driving shaft cable (Use with shaft 69-33/64" long .....	-	-	-	1	-
209851	Instrument board speedometer driving shaft clip .....	-	-	-	2	2
213056	Instrument board speedometer driving shaft clip (Style No. 15 x 1/4) .....	-	-	-	1	-
129773	Instrument board speedometer driving shaft clip (Style No. 1 x 5/16) .....	-	-	-	1	1
190231	Instrument board speedometer driving shaft toe board bushing .....	-	-	-	1	1
225007	Instrument board speedometer gasket .....	-	-	-	1	1
5310	Instrument board speedometer screw No. 8-32 x 1/4 round hd. ....	-	-	-	3	3
6472	Lockwasher No. 8 Shakeproof .....	-	-	-	3	2
3911	Instrument board speedometer reset washer .....	-	-	-	1	1
207800	Instrument board starter motor switch .....	-	-	-	1	1
213340	Instrument board starter motor switch base .....	-	-	-	1	1
213338	Instrument board starter motor switch button .....	-	-	-	1	1
203901	Instrument board starter motor switch insulator .....	-	-	-	1	-
225833	Instrument board starter motor switch washer .....	-	-	-	1	1
228501	Instrument board thermometer .....	-	-	-	1	1

## LAMP

201119	Lamp front-assembly .....	2	-	-	-	-
194004	Lamp front-and auxiliary bulb .....	2	-	-	-	-
203944	Lamp front-body assembly .....	2	-	-	-	-
201226	Lamp front-bracket-left .....	1	-	-	-	-
201227	Lamp front-bracket-right .....	1	-	-	-	-
194817	Lamp front-bracket bottom cover .....	2	-	-	-	-
7709	Retaining screw No. 10-32 x 7/16" fill. head .....	4	-	-	-	-
5500	Lockwasher 3/16" .....	4	-	-	-	-
194820	Lamp front-bracket plug .....	2	-	-	-	-
5348	Lamp front-bracket to fender screw 3/8-24 x 11/16" carriage .....	8	-	-	-	-
7006	Lamp front-bracket to fender screw nut 3/8-24 .....	8	-	-	-	-
203542	Lamp front-bracket to radiator shell pad .....	2	-	-	-	-
203496	Lamp front-bracket reinforcing plate right .....	1	-	-	-	-
203495	Lamp front-bracket reinforcing plate left .....	1	-	-	-	-
203487	Lamp front-bracket reinforcing plate screw .....	2	-	-	-	-
6047	Lockwasher 1/2" .....	2	-	-	-	-
203498	Lamp front-bracket reinforcing plate gasket .....	2	-	-	-	-

Piece No.	Name	No. Required				
		905 906	1005 1006	1107 1108	1207 1208	1407 1408
202413	Lamp front-bulb socket .....	2	-	-	-	-
194561	Lamp front-bulb socket and cable assembly .....	2	-	-	-	-
203941	Lamp front-door and glass assembly .....	2	-	-	-	-
203942	Lamp front-door glass .....	2	-	-	-	-
203943	Lamp front-door glass retainer .....	6	-	-	-	-
162980	Lamp front-door latch hinge-threaded .....	2	-	-	-	-
162750	Lamp front-door latch hinge-plain .....	2	-	-	-	-
202404	Lamp front-door latch hinge-male .....	2	-	-	-	-
143552	Lamp front-door latch hinge pin .....	2	-	-	-	-
202406	Lamp front-door latch hinge spring .....	2	-	-	-	-
203925	Lamp front-door latch hinge spring seat .....	2	-	-	-	-
170945	Lamp front-gasket .....	2	-	-	-	-
203945	Lamp front-reflector .....	2	-	-	-	-
202412	Lamp front-reflector gasket assembly .....	2	-	-	-	-
170879	Lamp front-retaining cup washer .....	2	-	-	-	-
171061	Lamp front-retaining nut .....	2	-	-	-	-
171588	Lamp front-retaining lockwasher .....	2	-	-	-	-
201228	Lamp front-brace bar .....	1	-	-	-	-
194819	Lamp front-brace bar clamp screw .....	2	-	-	-	-
141987	Nut 7/16-20 blind .....	2	-	-	-	-
5508	Lockwasher 7/16" .....	2	-	-	-	-
202429	Lamp fender-assembly .....	2	-	-	-	-
202685	Lamp fender-base .....	2	-	-	-	-
7901	Lamp fender-base to body screw-short .....	2	-	-	-	-
5346	Lamp fender-base to body screw-long .....	2	-	-	-	-
202683	Lamp fender-bulb retainer assembly .....	2	-	-	-	-
202427	Lamp fender-bulb socket spring .....	2	-	-	-	-
203962	Lamp fender-door and glass .....	2	-	-	-	-
203963	Lamp fender-door glass .....	2	-	-	-	-
202680	Lamp fender-door gasket .....	2	-	-	-	-
201755	Lamp fender-gasket .....	2	-	-	-	-
102590	Lamp fender-bulb .....	2	-	-	-	-
194818	Lamp fender-cable conduit .....	2	-	-	-	-
173357	Lamp fender-clamping plate .....	2	-	-	-	-
173364	Lamp fender-to fender screw .....	2	-	-	-	-
5728	Lockwasher 7/16" special .....	2	-	-	-	-
202684	Lamp fender-inside cable assembly .....	2	-	-	-	-
202679	Lamp fender-lamp reflector .....	2	-	-	-	-
202681	Lamp fender-yoke assembly .....	2	-	-	-	-
203964	Lamp fender-yoke attaching screw .....	2	-	-	-	-
186320	Lamp rear-left .....	1	-	-	-	-
203993	Lamp rear-left (with blue bull's eye) .....	1	-	-	-	-
203994	Lamp rear-right (with blue bull's eye) .....	1	-	-	-	-
186321	Lamp rear-right .....	1	-	-	-	-
7711	Screw 1/4-20 x 5/8" fill. head .....	4	-	-	-	-
5502	Lockwasher 1/4" .....	4	-	-	-	-
3868	Plain washer 1/4" .....	4	-	-	-	-
186327	Lamp rear-bracket left .....	1	-	-	-	-
186328	Lamp rear-bracket right .....	1	-	-	-	-
186329	Lamp rear-bracket gasket .....	4	-	-	-	-
7804	Lamp rear-bracket to support bracket bolt (Screw 5/16-18 x 3/4" hex. hd.) .....	6	-	-	-	-
5504	Lockwasher 5/16" .....	6	-	-	-	-
186330	Lamp rear-bracket license tag plate .....	1	-	-	-	-
190092	Lamp rear-bracket license tag plate clip .....	1	-	-	-	-
5898	Screw 1/4-20 x 9/16" .....	1	-	-	-	-
5502	Lockwasher 1/4" .....	1	-	-	-	-
190332	Lamp rear-bracket license tag plate clamp screw .....	1	-	-	-	-
190091	Lamp rear-bracket license tag plate clamp screw nut .....	1	-	-	-	-



Piece No.	Name	No. Required				
		905 906	1005 1006	1107 1108	1207 1208	1407 1408
5502	Lockwasher 1/4" .....	1	-	-	-	-
190193	Lamp rear-bracket support .....	2	-	-	-	-
5449	Lamp rear-bracket support to frame screw 5/16-24 x 3/4" hex. hd. (Used on 905 only) .....	4	-	-	-	-
7809	Screw 5/16-24 x 7/8" hex. hd. (Used on 906 only) ...	4	-	-	-	-
5504	Lockwasher 5/16" .....	4	-	-	-	-
7005	Nut 5/16-24 .....	4	-	-	-	-
194539	Lamp rear-bracket support spacer (Used on 906 only) ....	2	-	-	-	-
102590	Lamp rear-bulb .....	2	-	-	-	-
194449	Lamp rear-bulb retainer assembly .....	2	-	-	-	-
194444	Lamp rear-door assembly .....	2	-	-	-	-
205955	Lamp rear-door assembly (with blue bull's eye) .....	2	-	-	-	-
205956	Lamp rear-door glass (with blue bull's eye) .....	2	-	-	-	-
194446	Lamp rear-door glass .....	2	-	-	-	-
134447	Lamp rear-door glass gasket .....	2	-	-	-	-
194448	Lamp rear-door lock screw .....	2	-	-	-	-
194450	Lamp rear-left license glass .....	1	-	-	-	-
194975	Lamp rear-left license glass gasket .....	1	-	-	-	-
194453	Lamp rear-left license glass retainer .....	1	-	-	-	-
70296	Lamp rear-left license glass retainer screw .....	2	-	-	-	-
116458	Lamp rear-stop light bulb .....	2	-	-	-	-
194669	Lamp running-board .....	2	-	-	-	-
102590	Lamp running-board bulb .....	2	-	-	-	-
163484	Lamp running-board cable connector .....	3	-	-	-	-
143442	Lamp running-board cable connector insulator .....	3	-	-	-	-
194668	Lamp running-board conduit .....	2	-	-	-	-
183072	Lamp running-board cable connector insulator .....	3	-	-	-	-
185064	Lamp running-board glass and rim assembly .....	2	-	-	-	-
185063	Lamp running-board socket assembly .....	2	-	-	-	-
185065	Lamp running-board to splasher screw .....	8	-	-	-	-

## LAMP

209038	Lamp front assembly-left .....	-	1	1	-	-
209039	Lamp front assembly-right .....	-	1	1	-	-
213262	Lamp front body assembly .....	-	2	2	-	-
209323	Lamp front bracket left .....	-	1	1	-	-
209324	Lamp front bracket right .....	-	1	1	-	-
6292	Stud .....	-	4	4	-	-
7007	Nut 7/16" .....	-	4	4	-	-
5508	Lockwasher 7/16" .....	-	4	4	-	-
209322	Bolt .....	-	2	2	-	-
5514	Lockwasher 5/8" .....	-	2	2	-	-
3891	Washer .....	-	2	2	-	-
5595	Lamp front-bracket clamp screw 3/8-24 x 2-1/16" hex. hd.	-	2	2	-	-
5506	Lockwasher 3/8" .....	-	2	2	-	-
7006	Nut 3/8-24 .....	-	2	2	-	-
209684	Lamp front bracket to fender clamp plate .....	-	2	2	-	-
209308	Lamp front bracket to fender gasket .....	-	2	2	-	-
209722	Lamp front cable tube left assembly .....	-	1	1	-	-
209723	Lamp front cable tube right assembly .....	-	1	1	-	-
7824	Screw 1/4-28 x 5/8" hex. hd. ....	-	4	4	-	-
7004	Nut 1/4-28 .....	-	4	4	-	-
5502	Lockwasher 1/4" .....	-	4	4	-	-
213269	Lamp front contact plug assembly right .....	-	1	1	-	-
213270	Lamp front contact plug assembly left .....	-	1	1	-	-
213261	Lamp front contact plug set screw .....	-	2	2	-	-
213263	Lamp front door and glass assembly right .....	-	1	1	-	-

SERVICE PARTS LIST—PACKARD TWELVE

Lamp 75

Piece No.	Name	No. Required				
		905 906	1005 1006	1107 1108	1207 1208	1407 1408
213264	Lamp front door and glass assembly left .....	-	1	1	-	-
213265	Lamp front door glass right .....	-	1	1	-	-
213266	Lamp front door glass left .....	-	1	1	-	-
203943	Lamp front door glass retainer .....	-	2	2	-	-
162980	Lamp front door latch hinge (threaded) .....	-	2	2	-	-
162750	Lamp front door latch hinge (plain) .....	-	2	2	-	-
202404	Lamp front door latch hinge male .....	-	2	2	-	-
143522	Lamp front door latch hinge pin .....	-	2	2	-	-
202406	Lamp front door latch hinge spring .....	-	2	2	-	-
203925	Lamp front door latch hinge spring seat .....	-	2	2	-	-
209404	Lamp front fender bracket junction box right .....	-	1	1	-	-
209403	Lamp front fender bracket junction box left .....	-	1	1	-	-
209726	Lamp front fender bracket junction box plate .....	-	2	2	-	-
7007	Nut 7/16-20 .....	-	4	4	-	-
5508	Lockwasher 7/16" .....	-	4	4	-	-
210865	Lamp front main bulb (32-32-32 C.P.) (Triple contact) ..	-	2	2	-	-
213247	Lamp front main bulb sockets and cables assembly left ..	-	1	1	-	-
213248	Lamp front main bulb sockets and cables assembly right ..	-	1	1	-	-
213258	Lamp front main bulb retainer spring .....	-	2	2	-	-
213254	Lamp front main bulb socket .....	-	2	2	-	-
213249	Lamp front main bulb socket spring .....	-	2	2	-	-
213268	Lamp front reflector right .....	-	1	1	-	-
213267	Lamp front reflector left .....	-	1	1	-	-
202412	Lamp front reflector gasket .....	-	2	2	-	-
202429	Lamp fender assembly .....	-	2	2	-	-
202685	Lamp fender base .....	-	2	2	-	-
7901	Lamp fender base to body screw short .....	-	2	2	-	-
5346	Lamp fender base to body screw long .....	-	2	2	-	-
102590	Lamp fender bulb .....	-	2	2	-	-
202683	Lamp fender bulb retainer assembly .....	-	2	2	-	-
202427	Lamp fender bulb, socket spring .....	-	2	2	-	-
202684	Lamp fender inside cable assembly .....	-	2	2	-	-
173357	Lamp fender clamping plate .....	-	2	2	-	-
202680	Lamp fender door gasket .....	-	2	2	-	-
203962	Lamp fender door and glass .....	-	2	2	-	-
203963	Lamp fender door glass .....	-	2	2	-	-
173364	Lamp fender to fender screw .....	-	2	2	-	-
201755	Lamp fender gasket .....	-	2	2	-	-
202679	Lamp fender reflector .....	-	2	2	-	-
202681	Lamp fender yoke assembly .....	-	2	2	-	-
203964	Lamp fender yoke attaching screw .....	-	2	2	-	-
209265	Lamp rear right and bracket assembly .....	-	1	-	-	-
209266	Lamp rear left and bracket assembly .....	-	1	-	-	-
215011	Lamp rear right and bracket assembly .....	-	-	1	-	-
215010	Lamp rear left and bracket assembly .....	-	-	1	-	-
205923	Lamp rear left bracket .....	-	1	-	-	-
213926	Lamp rear left bracket .....	-	-	1	-	-
205924	Lamp rear right bracket .....	-	1	-	-	-
213927	Lamp rear right bracket .....	-	-	1	-	-
5456	Screw 5/16-18 x 3/4" hex. hd. ....	-	4	2	-	-
6185	Screw 5/16-18 x 5/8" hex. hd. ....	-	-	2	-	-
176864	Washer 5/16" .....	-	-	4	-	-
5504	Lockwasher 5/16" std. ....	-	4	4	-	-
3874	Washer 5/16" "N" std. ....	-	4	-	-	-
202421	Lamp rear to bracket screw .....	-	4	4	-	-
196950	Lamp rear bracket to fender gasket .....	-	2	-	-	-
213921	Lamp rear bracket left to fender gasket .....	-	-	1	-	-
213922	Lamp rear bracket right to fender gasket .....	-	-	1	-	-
196330	Lamp rear bracket license tag plate .....	-	1	1	-	-
130092	Lamp rear bracket license tag plate clip .....	-	1	1	-	-
5898	Screw 1/4-20 x 9/16" round head .....	-	1	1	-	-

Piece No.	Name	No. Required				
		905 906	1005 1006	1107 1108	1207 1208	1407 1408
5502	Lockwasher 1/4" std. ....	-	1	1	-	-
190332	Lamp rear bracket license tag plate clamp screw .....	-	1	1	-	-
190091	Lamp rear bracket license tag plate clamp screw nut ....	-	1	1	-	-
5502	Lockwasher 1/4" std. ....	-	1	1	-	-
213348	Lamp rear left body assembly .....	-	1	-	-	-
216610	Lamp rear left body assembly .....	-	-	1	-	-
216611	Lamp rear right body assembly .....	-	-	1	-	-
213349	Lamp rear right body assembly .....	-	1	-	-	-
202422	Lamp rear body grommet .....	-	2	2	-	-
102590	Lamp rear bulb .....	-	2	2	-	-
213350	Lamp rear bulb socket assembly .....	-	2	-	-	-
216617	Lamp rear bulb socket assembly .....	-	-	2	-	-
202427	Lamp rear bulb socket spring .....	-	4	4	-	-
202425	Lamp rear cable assembly .....	-	2	2	-	-
213992	Lamp rear cable insulator .....	-	-	2	-	-
213351	Lamp rear cable and sockets assembly .....	-	2	-	-	-
216618	Lamp rear cable and sockets assembly .....	-	-	2	-	-
216613	Lamp rear door and glass assembly .....	-	-	2	-	-
205955	Lamp rear door and glass assembly .....	-	2	-	-	-
205956	Lamp rear door glass .....	-	2	2	-	-
194447	Lamp rear door glass gasket .....	-	2	2	-	-
194448	Lamp rear door lockscrew .....	-	2	2	-	-
194450	Lamp rear left license glass .....	-	1	-	-	-
216615	Lamp rear left license glass .....	-	-	1	-	-
216616	Lamp rear left license glass gasket .....	-	-	1	-	-
194975	Lamp rear left license glass gasket .....	-	1	-	-	-
194453	Lamp rear license glass retainer .....	-	1	1	-	-
70296	Lamp rear license glass retainer screw .....	-	2	2	-	-
203301	Lamp rear stop light bulb (15 C.P.) .....	-	2	2	-	-
202426	Lamp rear stop light cable assembly .....	-	2	2	-	-
194669	Lamp running board .....	-	2	-	-	-
215506	Lamp running board .....	-	-	2	-	-
102590	Lamp running board bulb .....	-	2	2	-	-
163484	Lamp running board cable connector .....	-	3	-	-	-
143442	Lamp running board cable connector insulator .....	-	3	-	-	-
183072	Lamp running board cable connector insulator .....	-	3	-	-	-
194668	Lamp running board conduit .....	-	2	-	-	-
181221	Lamp running board conduit .....	-	-	2	-	-
209851	Lamp running board conduit clip .....	-	-	2	-	-
185064	Lamp running board glass and rim assembly .....	-	2	2	-	-
185063	Lamp running board socket assembly .....	-	3	3	-	-
185065	Lamp running board to splasher screw .....	-	3	3	-	-
185031	Lamp running board switch (Used on body 739) .....	-	-	2	-	-

**LAMP**  
(Specify color)

218823	Lamp courtesy assembly .....	-	-	-	2	2
181221	Lamp courtesy conduit .....	-	-	-	2	2
102590	Lamp courtesy bulb .....	-	-	-	2	2
185064	Lamp courtesy-glass and rim .....	-	-	-	2	2
226583	Lamp courtesy-rim to fender screw .....	-	-	-	3	3
218824	Lamp courtesy-socket assembly .....	-	-	-	2	2
220761	Lamp courtesy-switch .....	-	-	-	2	2
225689	Lamp fender assembly (Specify color) .....	-	-	-	2	2
225655	Lamp fender bulb (Mazda No. 55 - 1-1/2 C.P.) .....	-	-	-	2	2
194465	Lamp fender cable to fender bracket clip .....	-	-	-	2	2
3867	Washer plain 13/64 x 5/8 x 1/16" .....	-	-	-	2	2
225748	Lamp fender cable insulator .....	-	-	-	2	2

## SERVICE PARTS LIST—PACKARD TWELVE

Lamp 77

Piece No.	Name	No. Required				
		905 906	1003 1006	1107 1108	1207 1208	1407 1408
225741	Lamp fender clamping plate .....	-	-	-	2	2
228678	Lamp fender door assembly .....	-	-	-	2	2
228679	Lamp fender door glass .....	-	-	-	2	2
228680	Lamp fender door glass gasket .....	-	-	-	2	2
225756	Lamp fender extension cable assembly .....	-	-	-	2	2
201737	Lamp fender extension cable connector tip-female .....	-	-	-	2	2
228615	Lamp fender extension cable connector tip-male .....	-	-	-	2	2
202926	Lamp fender extension cable connector tip insulator ....	-	-	-	2	2
173364	Lamp fender to fender screw .....	-	-	-	2	2
5728	Lockwasher 7/16" special .....	-	-	-	2	2
225740	Lamp fender gasket .....	-	-	-	2	2
228681	Lamp fender reflector .....	-	-	-	2	2
225965	Lamp front assembly right (Without parking bulb) (Specify color) .....	-	-	-	1	1
228542	Lamp front assembly right (Without parking bulb) (Chromium) .....	-	-	-	1	1
225966	Lamp front assembly left (Without parking bulb) (Specify color) .....	-	-	-	1	1
228543	Lamp front assembly left (Without parking bulb) (Chromium) .....	-	-	-	1	1
225969	Lamp front assembly right (With parking bulb) (Specify color) .....	-	-	-	1	1
228546	Lamp front assembly right (With parking bulb) (Chromium)	-	-	-	1	1
225970	Lamp front assembly left (With parking bulb) (Specify color) .....	-	-	-	1	1
228547	Lamp front assembly left (With parking bulb) (Chromium).	-	-	-	1	1
231110	Lamp front body bead .....	-	-	-	2	2
231111	Lamp front body bead retainer .....	-	-	-	2	2
6379	Screw .....	-	-	-	10	10
225961	Lamp front bracket left (Specify color) .....	-	-	-	1	-
230247	Lamp front bracket left (Specify color) .....	-	-	-	-	1
225962	Lamp front bracket right (Specify color) .....	-	-	-	1	-
230248	Lamp front bracket right (Specify color) .....	-	-	-	-	1
225661	Lamp front bracket to fender gasket left .....	-	-	-	1	-
230249	Lamp front bracket to fender gasket left .....	-	-	-	-	1
225662	Lamp front bracket to fender gasket right .....	-	-	-	1	-
230250	Lamp front bracket to fender gasket right .....	-	-	-	-	1
225659	Lamp front to bracket grommet .....	-	-	-	2	2
167261	Lamp front to bracket grommet screw .....	-	-	-	6	-
304308	Lamp front to bracket grommet screw .....	-	-	-	-	6
225149	Lamp front bracket stud-long .....	-	-	-	2	2
225706	Lamp front bracket stud-short .....	-	-	-	2	2
3884	Washer 1/2" plain .....	-	-	-	8	8
6047	Lockwasher 1/2" Shakeproof .....	-	-	-	8	8
7008	Nut 1/2-20 .....	-	-	-	4	4
228548	Lamp front bracket screw 1/2-13 hex. hd. ....	-	-	-	2	2
223978	Lamp front bulb .....	-	-	-	2	2
225876	Lamp front connecting plug .....	-	-	-	2	2
225878	Lamp front door fastening screw .....	-	-	-	2	2
0239017	Lamp front door fastening screw bracket .....	-	-	-	2	2
225866	Lamp front door and glass assembly-right .....	-	-	-	1	1
225867	Lamp front door and glass assembly-left .....	-	-	-	1	1
225868	Lamp front door glass-right .....	-	-	-	1	1
225869	Lamp front door glass-left .....	-	-	-	1	1
225870	Lamp front door glass retainer .....	-	-	-	2	2
170945	Lamp front gasket .....	-	-	-	2	2
225958	Lamp front mounting stud nut 1/2-13 .....	-	-	-	2	2
225655	Lamp front parking bulb (Mazda No. 55 - 1-1/2 C.P.) ....	-	-	-	2	2
225871	Lamp front reflector assembly .....	-	-	-	2	2
225877	Lamp front reflector assembly (Use with fender lamps) ..	-	-	-	2	2
225873	Lamp front reflector gasket .....	-	-	-	2	2

Piece No.	Name	No. Required					
		905 906	1005 1006	1107 1108	1207 1208	1407 1408	
182450	Lubricator drip plug No. 2 (.3 flow per minute)	Front axle spring front shackle bracket .....	2	2	2	-	-
		Rear axle spring rear shackle bracket .....	2	2	2	-	-
		Brake front operating shaft support arm bracket .....	2	-	-	-	-
		Universal joint bearing .....	1	-	-	-	-
		Front axle spring rear bracket left .....	-	1	1	-	-
194001	Lubricator drip plug No. 00 (.04 CC flow per minute)	Brake cross shaft .....	2	2	2	-	-
		Clutch throwout bearing .....	1	1	1	-	-
		Clutch shifter lever .....	1	-	-	-	-
		Clutch and brake pedal .....	1	1	1	-	-
221577	Lubricator drip plug No. 000 (.03 CC flow per minute)						
		Clutch throwout bearing .....	-	-	-	1	1
230008	Lubricator drip plug assembly						
		Clutch throwout bearing - at transmission .....	-	-	-	1	1
225273	Lubricator drip plug (LJB No. 00 type L) (.04 CC flow per minute)	Clutch throwout bearing .....	-	-	-	1	1
		Brake cross shaft .....	-	-	-	2	2
		Lubricator tube junction (5-way) .	-	-	-	1	1
225270	Lubricator drip plug (LSA No. 00 type L) (.04 CC flow per minute)						
		Clutch release lever .....	-	-	-	1	1
225297	Lubricator drip plug (LTC No. 00 type L) (.04 CC flow per minute)						
		Clutch and brake pedal .....	-	-	-	1	1
225293	Lubricator drip plug (LTA No. 2 type L) (.03 CC flow per minute)						
		Rear axle spring rear shackle bracket .....	-	-	-	2	2
225271	Lubricator drip plug (LSA No. 1 type L) (.15 flow per minute)						
		Rear axle spring front bracket ...	-	-	-	2	2
225272	Lubricator drip plug (LSA No. 2 type L) (.3 flow per minute)	Front axle spring rear bracket ...	-	-	-	2	2
		Front axle spring front shackle bracket .....	-	-	-	2	2
182123	Lubricator tank assembly (Internal repairs not furnish- ed-Return to Factory) .....	1	-	-	-	-	
207326	Lubricator tank assembly (Internal repairs not furnished-Return to Factory) .....	-	1	1	-	-	
225312	Lubricator tank assembly .....	-	-	-	1	1	
5578	Lubricator tank screw 5/16-24 x 7/8" hex. hd. ....	3	2	2	2	2	
5504	Lockwasher 5/16" .....	3	2	2	2	2	
3874	Washer 5/16" plain .....	3	2	2	2	2	

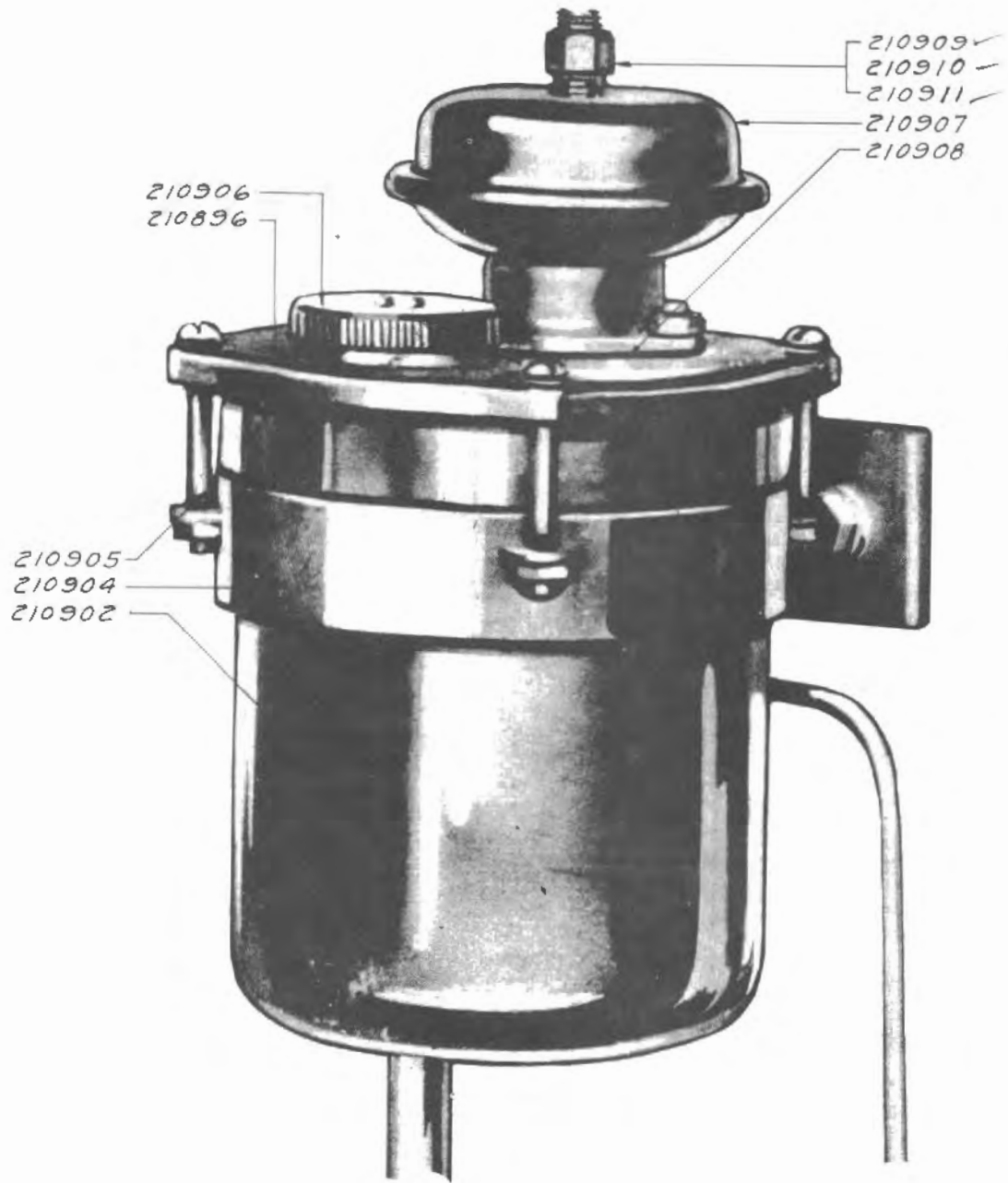

1005-6-1107-8



Piece No.	Name	No. Required				
		905 906	1005 1006	1107 1108	1207 1208	1407 1408
210896	Lubricator tank cover plate and pump assembly .....	-	1	1	-	-
185433	Lubricator tank damper connection No. 1 .....	1	-	-	-	-
191911	Lubricator tank damper connection No. 2 .....	1	-	-	-	-
191912	Lubricator tank damper connection No. 3 .....	1	-	-	-	-
185363	Lubricator tank filler cap .....	1	-	-	-	-
210908	Lubricator tank filler cap .....	-	1	1	-	-
210902	Lubricator tank glass reservoir .....	-	1	1	-	-
210903	Lubricator tank glass reservoir gasket .....	-	1	1	-	-
225620	Lubricator tank to junction vacuum tube assembly .....	-	-	-	1	1
6260	Nut 3/16 flared tube inverted weatherhead .....	-	-	-	1	1
143130	Lubricator tank to junction vacuum tube clip .....	-	-	-	1	1
225508	Lubricator tank to junction vacuum tube hose assembly ..	-	-	-	1	1
210904	Lubricator tank mounting bracket assembly .....	-	1	1	-	-
210905	Screw .....	-	4	4	-	-
7003	Nut .....	-	4	4	-	-
210907	Lubricator tank pump diaphragm unit .....	-	1	1	-	-
7003	Nut .....	-	2	2	-	-
210908	Gasket .....	-	1	1	-	-
210900	Lubricator tank pump filter clamp ring .....	-	1	1	-	-
210899	Lubricator tank pump filter disc .....	-	1	1	-	-
210897	Lubricator tank pump filter disc support .....	-	1	1	-	-
210898	Lubricator tank pump filter screen .....	-	1	1	-	-
210901	Lubricator tank pump filter snap ring .....	-	1	1	-	-
210910	Lubricator tank pump vacuum regulator (Damper conn. No. 1-1/2) .....	-	1	1	-	-
210909	Lubricator tank pump vacuum regulator (Damper conn. No. 2) .....	-	1	1	-	-
210911	Lubricator tank pump vacuum regulator (Damper conn. No. 3) .....	-	1	1	-	-
184332	Lubricator tank suction tube long assembly .....	1	-	-	-	-
184333	Union nut .....	2	-	-	-	-
191150	Lubricator tank suction tube short assembly .....	1	-	-	-	-
209015	Lubricator tank suction tube short assembly .....	-	1	1	-	-
6256	Connector 3/16" flared tube-inverted (Weatherhead) .	-	1	-	-	-
6260	Nut 3/16" flared tube-inverted (Weatherhead) .....	-	1	1	-	-
184610	Lubricator tank suction tube short compression sleeve ..	1	-	-	-	-
183465	Lubricator tank suction tube short union nut .....	1	-	-	-	-
184611	Lubricator tank suction tube short union nut .....	1	-	-	-	-
190916	Lubricator tank suction tube dash connection tee (Closed car) .....	1	-	-	-	-
190925	Lubricator tank suction tube dash connection tee (Open car) .....	1	-	-	-	-
5805	Lubricator tank suction tube dash connection tee lockwasher .....	1	-	-	-	-
7006	Nut 3/8-24 hex. ....	1	-	-	-	-
190920	Lubricator tank suction tube dash connection elbow .....	1	-	-	-	-
5843	Lockwasher 5/8" .....	1	-	-	-	-
184335	Nut .....	1	-	-	-	-
183153	Washer .....	1	-	-	-	-
157688	Lubricator tank suction tube short assembly flared tube connection adapter .....	1	-	-	-	-
184610	Lubricator tank tube compression sleeve .....	-	2	2	1	1
184611	Lubricator tank tube union nut .....	-	2	2	-	-
184609	Lubricator tank tube union nut .....	-	-	-	1	1
147381	Lubricator transmission drip plug adapter .....	1	1	-	-	-
201049	Lubricator transmission throwout bearing drip plug oil hole restriction .....	-	1	-	-	-
225292	Lubricator tube adapter assembly .....	-	-	-	2	2
225275	Lubricator tube compression bushing .....	-	-	-	1	-

Part No.	Name	No. Required				
		905 906	1005 1006	1107 1108	1207 1208	1407 1408
225348	Lubricator tube compression bushing sleeve .....	-	-	-	1	-
225315	Lubricator tube compression nut assembly .....	-	-	-	1	1
146272	Lubricator tube compression sleeve .....	31	21	21	-	-
146274	Lubricator tube drip plug union nut .....	20	12	12	-	-
170401	Lubricator tube grommet .....	-	-	-	6	6
225289	Lubricator tube junction assembly (5-way) .....	-	-	-	1	1
225276	Lubricator tube junction assembly (4-way) .....	-	-	-	3	2
5317	Lubricator tube junction screw 1/4-28 x 1-1/8" hex. hd..	-	-	-	4	4
5502	Lubricator tube junction screw lockwasher 1/4" plain ...	-	-	-	4	4
7004	Lubricator tube junction screw nut 1/4-28 plain .....	-	-	-	4	4
146269	Lubricator tube junction (3-way) .....	3	3	3	-	-
5852	Screw 1/4-28 x 1-7/8" hex. hd. ....	3	-	-	-	-
5434	Screw 1/4-28 x 1-5/8" hex. hd. ....	-	1	1	-	-
7004	Nut 1/4-28 plain .....	3	3	1	-	-
5502	Lockwasher 1/4" .....	3	3	1	-	-
146273	Lubricator tube to junction union nut .....	11	9	9	-	-
170401	Lubricator tube rear grommet .....	4	4	4	-	-
146412	Lubricator tube tee clamp .....	15	8	8	-	-
134483	Tubing 3/16 x 1/32" .....	x	x	x	-	-
98345	Tubing 5/32 O.D. x .25 Wall .....	-	-	-	x	x

## MOTOR CAMSHAFT

203062	Motor camshaft .....	1	-	-	-	-
209116	Motor camshaft .....	-	1	1	1	1
6141	Plug 3/4" pipe (Headless) .....	1	1	1	1	1
203063	Motor camshaft bearing No. 1 .....	1	1	1	1	1
203064	Motor camshaft bearing No. 2 and No. 3 .....	2	2	2	2	2
203065	Motor camshaft bearing No. 4 .....	1	1	1	1	1
66570	Motor camshaft bearing No. 4 plug 2" expansion .....	1	1	1	1	1
201070	Motor camshaft nut .....	1	1	1	1	1
201071	Motor camshaft nut lock .....	1	1	1	1	1
202895	Motor camshaft driving chain .....	1	1	1	1	1
197683	Motor camshaft oil pump drive gear .....	1	1	1	1	1
4558	Key No. 6 Woodruff .....	1	1	1	1	1
205200	Motor camshaft front bearing and retainer assembly .....	-	1	1	-	-
221040	Motor camshaft front bearing and retainer assembly .....	-	-	-	1	1
203039	Motor camshaft front bearing retainer .....	1	-	-	-	-
203050	Gasket .....	1	1	1	1	1
197648	Motor camshaft front bearing retainer dowel .....	2	2	2	2	2
6107	Stud 7/16 x 1-13/16" H.M. ....	3	3	3	3	3
7007	Nut 7/16-20 .....	3	3	3	3	3
5508	Lockwasher 7/16" .....	3	3	3	3	3
205160	Motor camshaft front bearing retainer oil restriction ..	-	1	1	-	-
205171	Motor camshaft front bearing retainer oil restriction spring .....	-	1	1	-	-
203923	Motor camshaft rocker lever assembly .....	24	24	24	24	24
201986	Motor camshaft rocker lever shaft .....	6	-	-	-	-
205172	Motor camshaft rocker lever shaft .....	-	6	6	6	6
197705	Motor camshaft rocker lever shaft plug .....	12	12	12	12	12
197711	Motor camshaft rocker lever shaft retaining screw .....	6	6	6	6	6
207525	Motor camshaft sprocket (Supersedes 202894) .....	1	1	1	1	1
207520	Motor camshaft sprocket hub (Supersedes 203043) .....	1	1	1	1	1
4506	Key No. 11 Woodruff .....	1	1	1	1	1
7857	Screw 5/16-18 x 1" .....	6	6	6	6	6
5504	Lockwasher 5/16" std. ....	6	6	6	6	6

Piece No.	Name	No. Required				
		905 906	1005 1006	1107 1108	1207 1208	1407 1408
<b>MOTOR CARBURETOR</b>						
210239	Motor carburetor assembly .....	-	1	1	-	-
205038	Motor carburetor assembly .....	1	-	-	-	-
219810	Motor carburetor assembly .....	-	-	-	1	1
0237812	Motor carburetor gasket equipment .....	1	1	1	1	1
201067	Motor carburetor gasket .....	1	1	1	1	1
219331	Motor carburetor front chamber baffle .....	-	1	1	-	-
197804	Motor carburetor retaining stud .....	4	4	4	4	4
5506	Lockwasher 3/8" .....	4	4	4	4	4
205429	Nut 3/8-24 .....	4	4	4	4	4
202868	Motor carburetor retracting spring .....	1	-	-	-	-
205611	Motor carburetor silencer assembly .....	1	1	1	1	1
5578	Screw 5/16-24 x 7/8" hex. hd. ....	2	2	2	2	2
3874	Washer 5/16" .....	2	2	2	2	2
5504	Lockwasher 5/16" .....	2	2	2	2	2
205687	Motor carburetor silencer gasket .....	1	1	1	1	1

### MOTOR CARBURETOR AUTOMATIC CHOKE

210243	Motor carburetor automatic choke assembly .....	-	1	1	1	1
203634	Motor carburetor automatic choke assembly .....	1	-	-	-	-
210245	Motor carburetor automatic choke to carburetor conn. rod assembly .....	-	1	1	1	1
7003	Nut No. 10-32 .....	-	1	1	1	1
5500	Lockwasher No. 10 .....	-	1	1	1	1
203822	Motor carburetor automatic choke to carburetor throttle lever control rod ball joint nut .....	1	-	-	-	-
203635	Motor carburetor automatic choke to manifold gasket ....	1	1	1	1	1
205078	Motor carburetor automatic choke to carburetor throttle lever control rod assembly .....	1	-	-	-	-
7003	Nut No. 10-32 .....	1	-	-	-	-
143143	Ball joint .....	1	-	-	-	-
4280	Cotter pin 1/16 x 1/2" .....	1	-	-	-	-
5935	Lockwasher .....	1	-	-	-	-
205044	Motor carburetor automatic choke to carburetor choke rod assembly .....	1	-	-	-	-
7003	Motor carburetor automatic choke to carburetor choke rod ball joint nut No. 10-32 .....	1	-	-	-	-
5500	Lockwasher .....	1	-	-	-	-
5295	Motor carburetor automatic choke screw .....	2	2	2	2	2
5502	Motor carburetor automatic choke screw lockwasher .....	2	2	2	2	2
3868	Motor carburetor automatic choke screw washer .....	2	2	2	2	2

### MOTOR CARBURETOR

The following parts are listed with the manufacturers' piece numbers and are to be ordered by these numbers. Dealers should order these parts through their distributor.

P-17770	Air horn (comp.) .....	1	-	-	-	-
P-17759	Air horn .....	1	-	-	-	-
P-17763L	Choke lever (comp.) .....	1	-	-	-	-
P-46L	Clamp screw .....	1	-	-	-	-
P-17777L	Choke lever stem .....	1	-	-	-	-
P-17071L	Choke lever stem collar .....	1	-	-	-	-
P-4755L	Choke lever stem collar .....	1	-	-	-	-



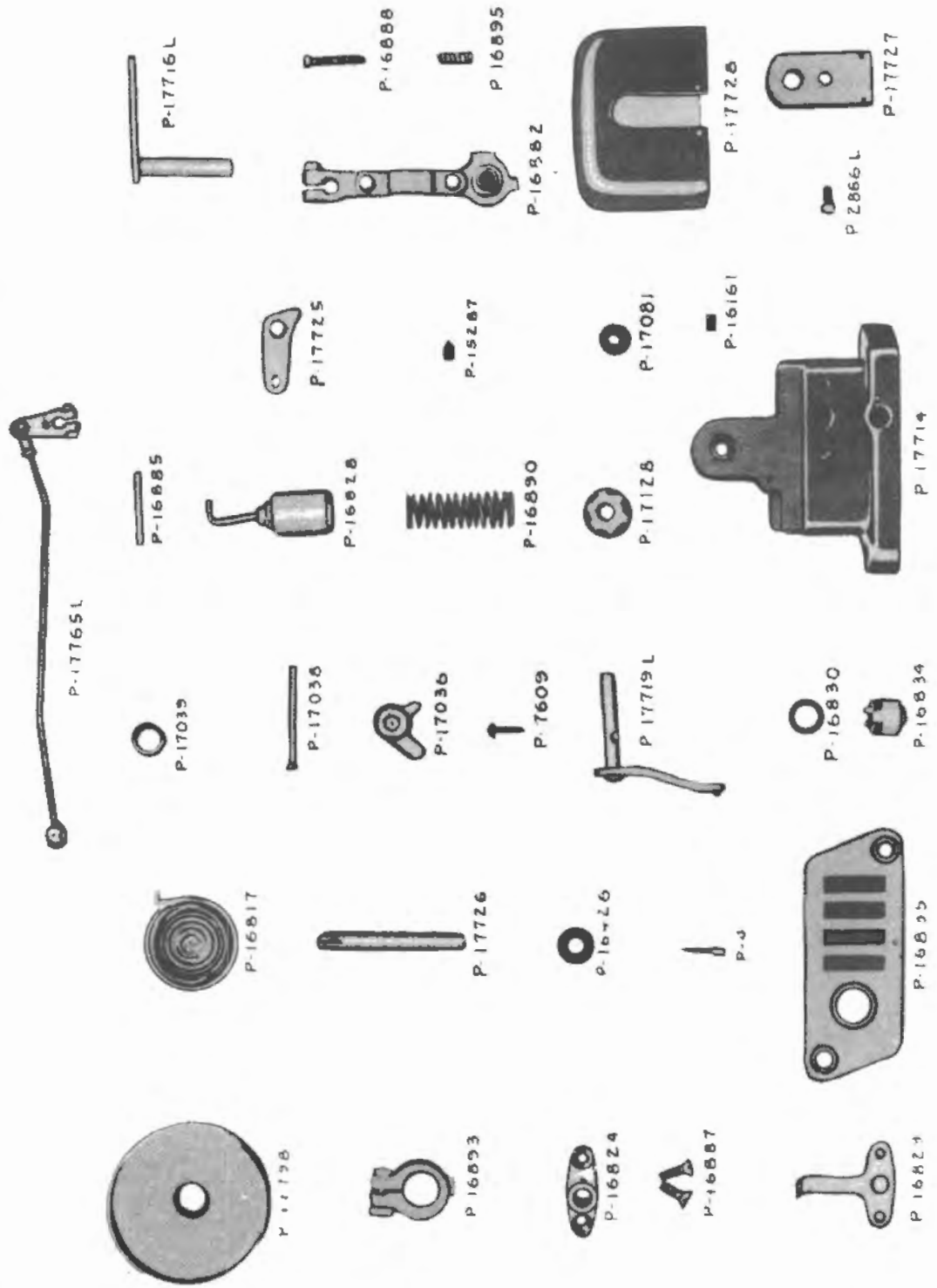

905-906

Piece No.	Name	No. Required				
		905 906	1005 1006	1107 1108	1207 1208	1407 1408
P-16161L	Choke lever stem collar set screw .....	1	-	-	-	-
P-17775	Choke valve (comp.) .....	1	-	-	-	-
P-4522	Choke valve screw .....	2	-	-	-	-
P-6406L	Float chamber cover plug .....	1	-	-	-	-
P-46L	Clamp screw .....	1	-	-	-	-
P-109L	Air horn attaching screw .....	4	-	-	-	-
P-3199L	Air horn attaching screw .....	1	-	-	-	-
P-6668L	Air horn attaching screw lockwasher .....	5	-	-	-	-
P-17394	Air horn gasket .....	1	-	-	-	-
P-17452L	Air horn attaching stud .....	1	-	-	-	-
P-17773	Air horn attaching stud .....	1	-	-	-	-
P-4729L	Air horn attaching stud nut .....	1	-	-	-	-
P-17774L	Air horn attaching stud nut .....	1	-	-	-	-
P-6664L	Air horn attaching stud lockwasher .....	1	-	-	-	-
P-16965	Econ. by pass jet (comp.) .....	1	-	-	-	-
P-17444	Float needle valve .....	1	-	-	-	-
P-17445	Float needle valve seat .....	1	-	-	-	-
P-11572	Float needle valve seat gasket .....	1	-	-	-	-
P-17464	Float with lever (comp.) .....	1	-	-	-	-
P-17473	Float hanger .....	1	-	-	-	-
P-17446L	Float fulcrum screw .....	1	-	-	-	-
P-17063	Float fulcrum screw gasket .....	1	-	-	-	-
P-15478L	Idle needle valve .....	2	-	-	-	-
P-15481L	Idle needle valve spring .....	2	-	-	-	-
P-17007	Idle tubes (comp.) .....	2	-	-	-	-
P-15477L	Idle air bleeders .....	2	-	-	-	-
P-15457L	Idle air bleeders channel plugs .....	2	-	-	-	-
P-6387L	Idle channel screw plug .....	2	-	-	-	-
P-15459L	Idle channel drive plug .....	2	-	-	-	-
P-17443	Main body .....	1	-	-	-	-
P-14393	Main body gasket .....	1	-	-	-	-
P-15554L	Main body attaching screw .....	4	-	-	-	-
P-6664L	Main body attaching screw lockwasher .....	4	-	-	-	-
P-17815	Main discharge jets .....	2	-	-	-	-
P-16978L	Main discharge jets plug .....	2	-	-	-	-
P-10666	Main discharge jets plug gaskets .....	2	-	-	-	-
P-17004	Metering jets .....	2	-	-	-	-
P-16990	Pump check valve (comp.) .....	1	-	-	-	-
P-7098L	Pump check valve channel plug .....	3	-	-	-	-
P-17448	Pump piston and link (comp.) .....	1	-	-	-	-
P-17450	Spring .....	1	-	-	-	-
P-17769	Pump discharge nozzles .....	2	-	-	-	-
P-17524	Pump lever (comp.) .....	1	-	-	-	-
P-6970	Pump lever stop screw .....	1	-	-	-	-
P-16973	Pump lever fulcrum screw .....	1	-	-	-	-
P-17009	Pump lever fulcrum screw washer .....	1	-	-	-	-
P-17133	Pump lever fulcrum screw spring washer .....	1	-	-	-	-
P-17027	Pump lever locking screw .....	1	-	-	-	-
P-17042	Pump spring .....	1	-	-	-	-
P-17060	Pump splash washer .....	1	-	-	-	-
P-17439L	Pump rod (comp.) .....	1	-	-	-	-
P-9394L	Pump rod washer .....	1	-	-	-	-
P-7170L	Pump rod washer cotter pin .....	1	-	-	-	-
P-9394	Pump link washer .....	1	-	-	-	-
P-7170L	Pump link washer cotter pin .....	1	-	-	-	-
P-17442	Pump housing .....	1	-	-	-	-
P-11531L	Pump housing attaching screw .....	1	-	-	-	-
P-6202	Pump discharge nozzle plugs .....	2	-	-	-	-
P-6406L	Pump discharge nozzle plugs .....	2	-	-	-	-



Piece No.	Name	No. Required				
		905 906	1005 1006	1107 1108	1207 1208	1407 1408
P-7098L	Pump discharge channel plugs .....	1	-	-	-	-
P-17406	Throttle valve body .....	1	-	-	-	-
P-17371	Throttle valve .....	2	-	-	-	-
P-15259	Throttle valve screw .....	4	-	-	-	-
P-1693	Throttle valve screw lockwasher .....	4	-	-	-	-
P-17706L	Throttle lever and stem (comp.) .....	1	-	-	-	-
P-15456L	Throttle stop screw .....	1	-	-	-	-
P-15831L	Throttle stop spring .....	1	-	-	-	-

NOTE:-When ordering venturi tubes, high speed bleeders, metering jets, pump discharge jets, or by-pass jets, specify the size number which is found stamped on each parts, and always state type of carburetor and serial number as well as model and make of car for which part is intended.

### AUTOMATIC CHOKE

P-16888	Adjusting screw .....	1	-	-	-	-
P-16895	Adjusting screw spring .....	1	-	-	-	-
P-17765L	Carburetor connecting rod (comp.) .....	1	-	-	-	-
P-17771L	Carburetor connecting rod and connection .....	1	-	-	-	-
P-17767L	Carburetor connecting rod choke lever .....	1	-	-	-	-
P-9025L	Carburetor connecting rod choke lever clamp screw ...	1	-	-	-	-
P-4517L	Carburetor connecting rod choke lever clamp screw nut.	1	-	-	-	-
P-17761L	Carburetor connecting rod ball joint .....	1	-	-	-	-
P-10750L	Carburetor connecting rod ball joint nut .....	1	-	-	-	-
P-6668L	Carburetor connecting rod ball joint nut washer .....	1	-	-	-	-
P-17812L	Carburetor connecting rod ball joint lock nut .....	1	-	-	-	-
P-16830	Check valve .....	1	-	-	-	-
P-16834	Check valve bushing .....	1	-	-	-	-
P-17716L	Choke lever with stem (comp.) .....	1	-	-	-	-
P-16882	Choke link with levers (comp.) .....	1	-	-	-	-
P-16931	Choke link lever screw .....	1	-	-	-	-
P-15287	Choke link lever set screw .....	1	-	-	-	-
P-16835	Flange gasket .....	1	-	-	-	-
P-17036	Kick lever with bushing .....	1	-	-	-	-
P-7609	Kick lever set screw .....	1	-	-	-	-
P-17039	Kick lever torsion spring .....	1	-	-	-	-
P-17038L	Kick lever torsion spring pin .....	1	-	-	-	-
P-17714	Main body .....	1	-	-	-	-
P-17728	Main body cover .....	1	-	-	-	-
P-17727	Main body plate .....	1	-	-	-	-
P-2866L	Main body plate attaching screw .....	1	-	-	-	-
P-17725	Piston kick lever .....	1	-	-	-	-
P-16885	Piston stop pin .....	1	-	-	-	-
P-16890	Piston spring .....	1	-	-	-	-
P-17128	Piston washer .....	1	-	-	-	-
P-16828	Piston with link (comp.) .....	1	-	-	-	-
P-17719L	Release lever with stem (comp.) .....	1	-	-	-	-
P-17081	Release lever stem collar .....	1	-	-	-	-
P-16161	Release lever stem collar set screw .....	1	-	-	-	-
P-16817	Thermostat .....	1	-	-	-	-
P-16824	Thermostat bracket .....	1	-	-	-	-
P-16887	Thermostat bracket screw .....	2	-	-	-	-
P-17798	Thermostat housing .....	1	-	-	-	-
P-16893	Thermostat housing clamp with screw (comp.) .....	1	-	-	-	-
P-9025	Clamp screw .....	1	-	-	-	-

Piece No.	Name	No. Required				
		905 906	1005 1006	1107 1108	1207 1208	1407 1408
P-4517	Clamp screw nut .....	1	-	-	-	-
P-16829	Thermostat pointer .....	1	-	-	-	-
P-17726	Thermostat stem .....	1	-	-	-	-
P-16426	Thermostat stem washer .....	1	-	-	-	-
P-4	Thermostat stem washer cotter pin .....	1	-	-	-	-

## MOTOR CARBURETOR

The following parts are listed with the manufacturers' piece numbers and are to be ordered by these numbers. Dealers should order these parts through their distributor.







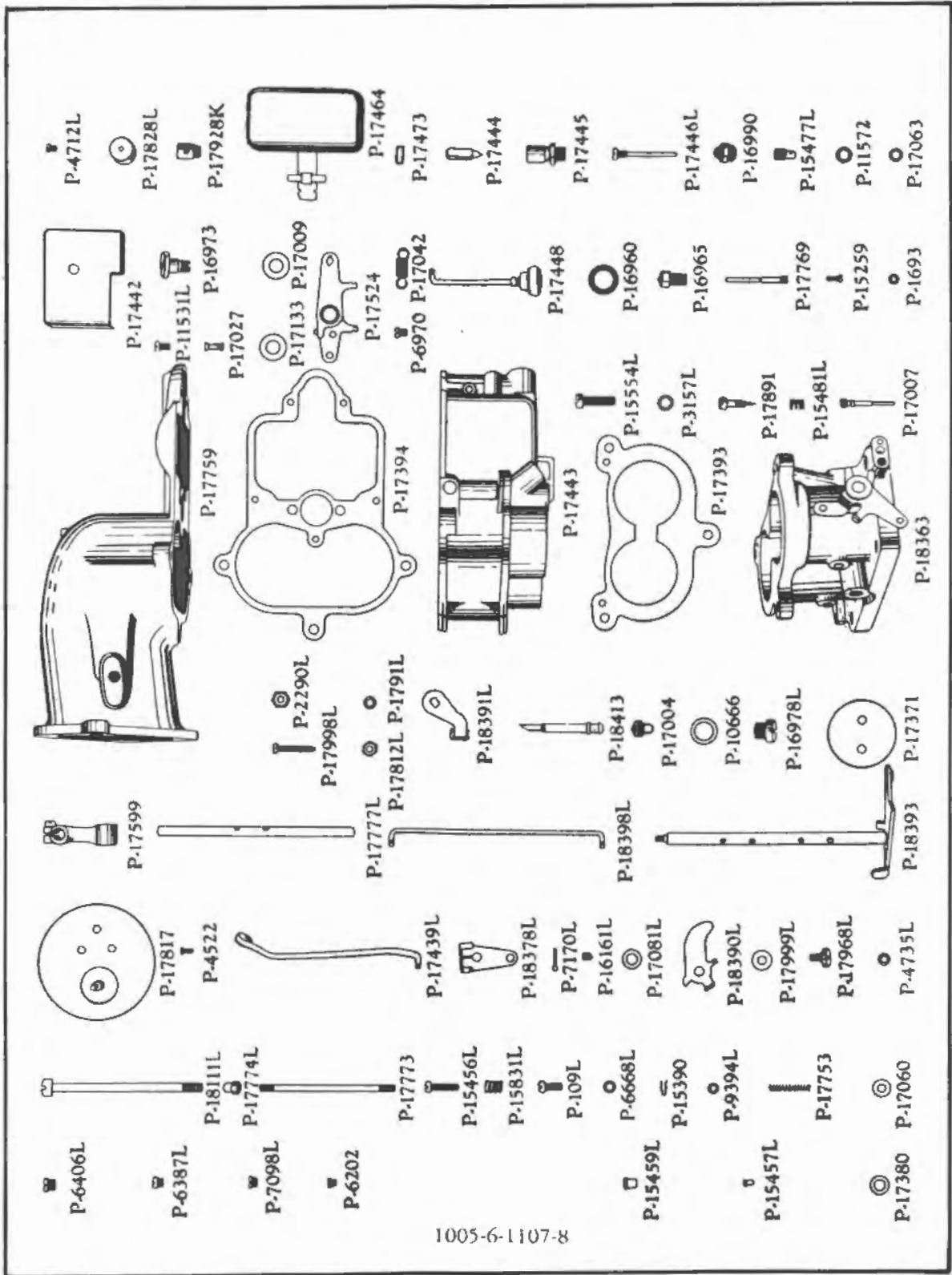













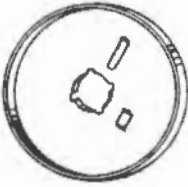

P-18409	Air horn with valve (comp.) .....	-	1	1	-	-
P-17759	Air horn .....	-	1	1	-	-
P-17599	Choke balance lever .....	-	1	1	-	-
P-46L	Choke balance lever clamp screw .....	-	1	1	-	-
P-18378L	Choke lever (comp.) .....	-	1	1	-	-
P-18300L	Choke lever clamp screw .....	-	1	1	-	-
P-18299L	Choke lever clamp screw nut .....	-	1	1	-	-
P-17777L	Choke lever stem .....	-	1	1	-	-
P-4735L	Choke stem washer .....	-	1	1	-	-
P-17081L	Choke stem collar .....	-	1	1	-	-
P-16161L	Choke stem collar set screw .....	-	1	1	-	-
P-17928K	Float chamber vent .....	-	1	1	-	-
P-17828L	Float chamber vent cap .....	-	1	1	-	-
P-4712L	Float chamber vent cap attaching screw .....	-	1	1	-	-
P-17817	Choke valve (comp.) .....	-	1	1	-	-
P-4522	Choke valve screws .....	-	2	2	-	-
P-18111L	Air horn attaching screw .....	-	1	1	-	-
P-3157L	Air horn attaching screw lockwasher .....	-	3	3	-	-
P-15554L	Air horn attaching screws .....	-	2	2	-	-
P-17773	Air horn attaching stud .....	-	1	1	-	-
P-17774L	Air horn attaching stud nut .....	-	1	1	-	-
P-6668L	Air horn attaching stud nut lockwasher .....	-	1	1	-	-
P-17394	Air horn gasket .....	-	1	1	-	-
P-16965	Economizer by-pass jet .....	-	1	1	-	-
P-109L	Float chamber cover screws .....	-	4	4	-	-
P-6668L	Float chamber cover screws lockwasher .....	-	4	4	-	-
P-17446L	Float fulcrum screw .....	-	1	1	-	-
P-17063	Float fulcrum screw gasket .....	-	1	1	-	-
P-17444	Float needle valve .....	-	1	1	-	-
P-17445	Float needle valve seat .....	-	1	1	-	-
P-11572	Float needle valve seat gasket.....	-	1	1	-	-
P-17464	Float with lever (comp.) .....	-	1	1	-	-
P-17473	Float hanger .....	-	1	1	-	-
P-18398L	Fast idle rod .....	-	1	1	-	-
P-7170L	Fast idle rod cotter pin .....	-	1	1	-	-
P-18391L	Fast idle adj. lever .....	-	1	1	-	-
P-17998L	Fast idle adj. lever screw .....	-	1	1	-	-
P-17812L	Fast idle adj. lever screw locknut .....	-	1	1	-	-
P-2290L	Fast idle adj. lever stem nut .....	-	1	1	-	-
P-1791L	Fast idle adj. lever stem nut lockwasher .....	-	1	1	-	-
P-18390L	Fast idle adj. lever .....	-	1	1	-	-
P-17968L	Fast idle adj. lever fulcrum screw .....	-	1	1	-	-
P-17999L	Fast idle adj. lever fulcrum screw washer .....	-	1	1	-	-
P-15477L	Idle air bleed .....	-	2	2	-	-
P-15457L	Idle air bleed channel plug .....	-	2	2	-	-

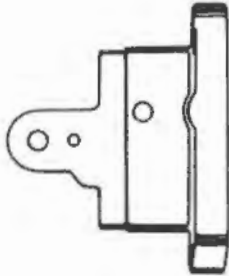
Piece No.	Name	No. Required				
		905 906	1005 1006	1107 1108	1207 1208	1407 1408
P-6387L	Idle channel screw plug .....	-	2	2	-	-
P-15459L	Idle channel screw plug .....	-	2	2	-	-
P-17891	Idle needle valve .....	-	2	2	-	-
P-15481L	Idle needle valve spring .....	-	2	2	-	-
P-17007	Idle tube .....	-	2	2	-	-
P-17443	Main body .....	-	1	1	-	-
P-15554L	Main body attaching screw .....	-	2	2	-	-
P-3157L	Main body attaching screw lockwasher .....	-	2	2	-	-
P-17393	Main body gasket .....	-	1	1	-	-
P-18413	Main discharge jet .....	-	2	2	-	-
P-16978L	Main discharge jet plug .....	-	2	2	-	-
P-10666	Main discharge jet plug gasket .....	-	2	2	-	-
P-17004	Main metering jet .....	-	2	2	-	-
P-16990	Pump check valve (comp.) .....	-	1	1	-	-
P-7098L	Pump check valve channel plug .....	-	4	4	-	-
P-17769	Pump discharge nozzle .....	-	2	2	-	-
P-6202	Pump discharge nozzle channel plug .....	-	2	2	-	-
P-6406L	Pump discharge nozzle channel plug (external) .....	-	2	2	-	-
P-17524	Pump lever (comp.) .....	-	1	1	-	-
P-6970	Pump lever stop screw .....	-	1	1	-	-
P-17042	Pump lever spring .....	-	1	1	-	-
P-16973	Pump lever fulcrum screw .....	-	1	1	-	-
P-17133	Pump lever fulcrum screw spring washer .....	-	1	1	-	-
P-17027	Pump lever fulcrum screw lock screw .....	-	1	1	-	-
P-17009	Pump lever fulcrum screw lock screw washer .....	-	1	1	-	-
P-17448	Pump piston and link (comp.) .....	-	1	1	-	-
P-16960	Pump piston spring .....	-	1	1	-	-
P-17753	Pump and link spring .....	-	1	1	-	-
P-15390	Pump and link spring cotter pin .....	-	1	1	-	-
P-9394L	Pump and link spring washer .....	-	1	1	-	-
P-17380	Pump and link felt washer .....	-	1	1	-	-
P-17060	Pump piston and link washer .....	-	1	1	-	-
P-7170L	Pump piston link cotter pin .....	-	1	1	-	-
P-17439L	Pump rod .....	-	1	1	-	-
P-7170L	Pump rod cotter pin .....	-	1	1	-	-
P-9394L	Pump rod washer .....	-	2	2	-	-
P-17442	Pump housing .....	-	1	1	-	-
P-11531L	Pump housing attaching screw .....	-	1	1	-	-
P-6668L	Pump housing attaching screw lockwasher .....	-	1	1	-	-
P-18393	Throttle lever and stem (comp.) .....	-	1	1	-	-
P-15456L	Throttle stop screw .....	-	1	1	-	-
P-15831L	Throttle stop screw spring .....	-	1	1	-	-
P-17371	Throttle valve .....	-	2	2	-	-
P-15259	Throttle valve screw .....	-	4	4	-	-
P-1693	Throttle valve screw lockwasher .....	-	4	4	-	-
P-18363	Throttle valve body .....	-	1	1	-	-
P-18389L	Fast idle bell crank lever .....	-	1	1	-	-
P-18394L	Fast idle bell crank lever bushing .....	-	1	1	-	-

NOTE:—When ordering venturi tubes, high speed bleeders, metering jets, pump discharge jets, or by-pass jets, specify the size number which is found stamped on each part, and always state type of carburetor and serial number as well as model and make of car for which part is intended.

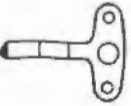

1005-6-1107-8

	P-17978		P-17992		P-18043		P-2369		P-17976		P-18318
	P-17988		P-18310		P-16426		P-2866L		P-18399		P-18271L
	P-18426		P-18424		P-16835		P-18425				
	P-16893		P-16824		P-17902		P-16829		P-16887		P-17985
	P-18397L										

1005-6-1107-8

Piece No.	Name	No. Required				
		905 906	1005 1006	1107 1108	1207 1208	1407 1408
<b>AUTOMATIC CHOKE</b>						
P-18397L	Carburetor connecting rod (comp.) .....	-	1	1	-	-
P-18396L	Carburetor connecting rod and connection .....	-	1	1	-	-
P-17761L	Carburetor connecting rod ball joint .....	-	1	1	-	-
P-16639L	Carburetor connecting rod ball joint nut .....	-	1	1	-	-
P-18399	Check valve bushing .....	-	1	1	-	-
P-16835	Flange gasket .....	-	1	1	-	-
P-18425	Main body .....	-	1	1	-	-
P-18424	Main body cover .....	-	1	1	-	-
P-2866L	Main body cover attaching screw .....	-	1	1	-	-
P-17992	Piston kick lever .....	-	1	1	-	-
P-2369	Piston kick lever set screw .....	-	1	1	-	-
P-18043	Piston kick lever set screw lockwasher .....	-	1	1	-	-
P-18318	Piston spring .....	-	1	1	-	-
P-17976	Piston with link (comp.) .....	-	1	1	-	-
P-17978	Piston lever (comp.) .....	-	1	1	-	-
P-17985	Piston lever stem .....	-	1	1	-	-
P-17902	Thermostat housing spacer .....	-	1	1	-	-
P-17988	Thermostat .....	-	1	1	-	-
P-16824	Thermostat bracket .....	-	1	1	-	-
P-16887	Thermostat bracket screw .....	-	2	2	-	-
P-18426	Thermostat housing .....	-	1	1	-	-
P-16893	Thermostat housing clamp with screw (comp.) .....	-	1	1	-	-
P-9025	Clamp screw .....	-	1	1	-	-
P-4517	Clamp screw nut .....	-	1	1	-	-
P-16829	Thermostat pointer .....	-	1	1	-	-
P-18271L	Thermostat lever and stem .....	-	1	1	-	-
P-16426	Thermostat lever washer .....	-	1	1	-	-
P-4	Thermostat lever washer cotter pin .....	-	1	1	-	-
P-18310	Thermostat cam (comp.) .....	-	1	1	-	-
P-18309	Thermostat cam .....	-	1	1	-	-
P-18300	Thermostat cam clamp screw .....	-	1	1	-	-
P-18299	Thermostat cam clamp screw nut .....	-	1	1	-	-

### MOTOR CARBURETOR

(Bendix Stromberg Carburetor Co. No. EE-3)

The following parts are listed with the manufacturers' piece numbers and are to be ordered by these numbers. Dealers should order these parts through their distributor.

P-18409	Air horn with valve (Comp.) .....	-	-	-	1	1
P-17759	Air horn .....	-	-	-	1	1
P-17599	Choke balance lever .....	-	-	-	1	1
P-46L	Choke balance lever clamp screw .....	-	-	-	1	1
P-18378L	Choke lever (Comp.) .....	-	-	-	1	1
P-18300L	Choke lever clamp screw .....	-	-	-	1	1
P-18299L	Choke lever clamp screw nut .....	-	-	-	1	1
P-17777L	Choke lever stem .....	-	-	-	1	1
P-4735L	Choke stem washer .....	-	-	-	1	1
P-17081L	Choke stem collar .....	-	-	-	1	1
P-16161L	Choke stem collar set screw .....	-	-	-	1	1
P-17928K	Float chamber vent .....	-	-	-	1	1
P-17828L	Float chamber vent cap .....	-	-	-	1	1



Piece No.	Name	No. Required				
		905 906	1005 1006	1107 1108	1207 1208	1407 1408
P-4712L	Float chamber vent cap attaching screw .....	-	-	-	1	1
P-17817	Choke valve (Comp.) .....	-	-	-	1	1
P-4522	Choke valve screws .....	-	-	-	2	2
P-18111L	Air horn attaching screw .....	-	-	-	1	1
P-3157L	Air horn attaching screw lockwasher .....	-	-	-	3	3
P-15554L	Air horn attaching screw .....	-	-	-	2	2
P-17773	Air horn attaching stud .....	-	-	-	1	1
P-17774L	Air horn attaching stud nut .....	-	-	-	1	1
P-6668L	Air horn attaching stud nut lockwasher .....	-	-	-	1	1
P-17394	Air horn gasket .....	-	-	-	1	1
P-16965	Economizer by-pass jet .....	-	-	-	1	1
P-109L	Float chamber cover screws .....	-	-	-	4	4
P-8669L	Float chamber cover screws lockwasher .....	-	-	-	4	4
P-17446L	Float fulcrum screw .....	-	-	-	1	1
P-17063	Float fulcrum screw gasket .....	-	-	-	1	1
P-17444	Float needle valve .....	-	-	-	1	1
P-17445	Float needle valve seat .....	-	-	-	1	1
P-11572	Float needle valve seat gasket .....	-	-	-	1	1
P-17464	Float with lever (Comp.) .....	-	-	-	1	1
P-17473	Float hanger .....	-	-	-	1	1
P-18398L	Fast idle rod .....	-	-	-	1	1
P-7170L	Fast idle rod cotter pin .....	-	-	-	1	1
P-18391L	Fast idle adj. lever .....	-	-	-	1	1
P-17998L	Fast idle adj. lever screw .....	-	-	-	1	1
P-17812L	Fast idle adj. lever screw locknut .....	-	-	-	1	1
P-2290L	Fast idle adj. lever stem nut .....	-	-	-	1	1
P-1791L	Fast idle adj. lever stem nut lockwasher .....	-	-	-	1	1
P-18390L	Fast idle adj. lever .....	-	-	-	1	1
P-17968L	Fast idle adj. lever fulcrum screw .....	-	-	-	1	1
P-17999L	Fast idle adj. lever fulcrum screw washer .....	-	-	-	1	1
P-15477L	Idle air bleed .....	-	-	-	2	2
P-15457L	Idle air bleed channel plug .....	-	-	-	2	2
P-6387L	Idle channel screw plug .....	-	-	-	2	2
P-15459L	Idle channel screw plug .....	-	-	-	2	2
P-17891	Idle needle valve .....	-	-	-	2	2
P-15481L	Idle needle valve spring .....	-	-	-	2	2
P-17007	Idle tube .....	-	-	-	2	2
P-17443	Main body .....	-	-	-	1	1
P-15554L	Main body attaching screws .....	-	-	-	2	2
P-3157L	Main body attaching screw lockwashers .....	-	-	-	2	2
P-17393	Main body gasket .....	-	-	-	1	1
P-20647	Main discharge jet .....	-	-	-	2	2
P-16978L	Main discharge jet plug .....	-	-	-	2	2
P-10666	Main discharge jet plug gasket .....	-	-	-	2	2
P-17004	Main metering jet .....	-	-	-	2	2
P-16990	Pump check valve (Comp.) .....	-	-	-	1	1
P-7098L	Pump check valve channel plug .....	-	-	-	4	4
P-17769	Pump discharge nozzle .....	-	-	-	2	2
P-6202	Pump discharge nozzle channel plug .....	-	-	-	2	2
P-6406L	Pump discharge nozzle channel plug (external) .....	-	-	-	2	2
P-17524	Pump lever (Comp.) .....	-	-	-	1	1
P-6970	Pump lever stop screw .....	-	-	-	1	1
P-17042	Pump lever spring .....	-	-	-	1	1
P-16973	Pump lever fulcrum screw .....	-	-	-	1	1
P-17133	Pump lever fulcrum screw spring washer .....	-	-	-	1	1
P-17027	Pump lever fulcrum screw lock screw .....	-	-	-	1	1
P-17009	Pump lever fulcrum screw lock screw washer .....	-	-	-	1	1
P-17448	Pump piston and link (Comp.) .....	-	-	-	1	1

SERVICE PARTS LIST—PACKARD TWELVE

Motor Connecting Rod 93

Piece No.	Name	No. Required				
		905 906	1005 1006	1107 1108	1207 1208	1407 1408
P-16960	Pump piston spring .....	-	-	-	1	1
P-17753	Pump and link spring .....	-	-	-	1	1
P-15390	Pump and link spring cotter pin .....	-	-	-	1	1
P-9394L	Pump and link spring washer .....	-	-	-	1	1
P-17380	Pump and link felt washer .....	-	-	-	1	1
P-17060	Pump piston and link washer .....	-	-	-	1	1
P-7170L	Pump piston link cotter pin .....	-	-	-	1	1
P-17439L	Pump rod .....	-	-	-	1	1
P-7170L	Pump rod cotter pin .....	-	-	-	1	1
P-9394L	Pump rod washer .....	-	-	-	2	2
P-17442	Pump housing .....	-	-	-	1	1
P-11531L	Pump housing attaching screw .....	-	-	-	1	1
P-6668L	Pump housing attaching screw lockwasher .....	-	-	-	1	1
P-18393	Throttle lever and stem (Comp.) .....	-	-	-	1	1
P-15456L	Throttle stop screw No. 10-24 .....	-	-	-	1	1
P-16566L	Throttle stop screw No. 10-32 .....	-	-	-	1	1
P-15831L	Throttle stop screw spring .....	-	-	-	1	1
P-17371	Throttle valve .....	-	-	-	2	2
P-15259	Throttle valve screw .....	-	-	-	4	4
P-1693	Throttle valve screw lockwasher .....	-	-	-	4	4
P-18363	Throttle valve body .....	-	-	-	1	1
P-18389L	Fast idle bell crank lever .....	-	-	-	1	1
P-18394L	Fast idle bell crank lever bushing .....	-	-	-	1	1

MOTOR CLUTCH SHAFT BEARING

205454	Motor clutch shaft bearing-front .....	1	1	1	1	1
--------	--	---	---	---	---	---

MOTOR CONNECTING ROD

216452	Motor connecting rod bolt 7/16-28 thd. (Supersedes 207763) .....	-	24	24	-	-
207681	Motor connecting rod bolt .....	24	-	-	-	-
162979	Motor connecting rod bolt nut 7/16-20 thd. ....	24	24	24	-	-
201020	Motor connecting rod bolt nut 7/16-28 thd. ....	-	-	24	-	-
219594	Motor connecting rod bolt nut .....	-	-	-	24	24
4291	Cotter pin 3/32" x 3/4" .....	24	24	24	24	24
98404	Motor connecting rod (less bearing)-right bank .....	6	6	6	-	-
98405	Motor connecting rod (less bearing)-left bank .....	6	6	6	-	-
219688	Motor connecting rod (less bearing)-right bank .....	-	-	-	6	6
219685	Motor connecting rod (less bearing)-left bank .....	-	-	-	6	6

Piece No.	Name	No. Required				
		905 906	1005 1006	1107 1108	1207 1208	1407 1408
NOTE: We recommend Babbitt bearings for 9th, 10th and 11th series motor which have no oil coolers.						
225202	Motor connecting rod bearing assembly-right bank-- standard (Copper lead).....	-	-	-	6	6
225203	Motor connecting rod bearing assembly-right bank-- .001 undersize (Copper lead) .....	-	-	-	6	6
225204	Motor connecting rod bearing assembly-right bank-- .002 undersize (Copper lead) .....	-	-	-	6	6
225205	Motor connecting rod bearing assembly-right bank-- .003 undersize (Copper lead) .....	-	-	-	6	6
225206	Motor connecting rod bearing assembly-right bank-- .015 undersize (Copper lead) .....	-	-	-	6	6
0237335	Motor connecting rod bearing assembly-right bank-- standard (Babbitt) .....	6	6	6	6	6
231080	Motor connecting rod bearing assembly-right bank-- .002 undersize (Babbitt) .....	6	6	6	6	6
231081	Motor connecting rod bearing assembly-right bank-- .005 undersize (Babbitt) .....	6	6	6	6	6
231082	Motor connecting rod bearing assembly-right bank-- .015 undersize (Babbitt) .....	6	6	6	6	6
225207	Motor connecting rod bearing assembly-left bank-- standard (Copper lead) .....	-	-	-	6	6
225208	Motor connecting rod bearing assembly-left bank-- .001 undersize (Copper lead) .....	-	-	-	6	6
225209	Motor connecting rod bearing assembly-left bank-- .002 undersize (Copper lead) .....	-	-	-	6	6
222510	Motor connecting rod bearing assembly-left bank-- .003 undersize (Copper lead) .....	-	-	-	6	6
222511	Motor connecting rod bearing assembly-left bank-- .015 undersize (Copper lead) .....	-	-	-	6	6
0237336	Motor connecting rod bearing assembly-left bank-- standard (Babbitt) .....	6	6	6	6	6
231083	Motor connecting rod bearing assembly-left bank-- .002 undersize (Babbitt) .....	6	6	6	6	6
231084	Motor connecting rod bearing assembly-left bank-- .005 undersize (Babbitt) .....	6	6	6	6	6
231085	Motor connecting rod bearing assembly-left bank-- .015 undersize (Babbitt) .....	6	6	6	6	6
213936	Motor connecting rod piston pin bushing (Supersedes 156648) .....	12	12	12	12	12
156494	Motor connecting rod piston pin bushing .002" oversize (on outside diameter) .....	x	x	x	x	x

Piece No.	Name	No. Required				
		905 906	1005 1006	1107 1108	1207 1208	1407 1408
<b>MOTOR CRANKCASE</b>						
223876	Motor crankcase breather tube .....	-	-	-	1	1
201222	Motor crankcase breather tube .....	1	1	1	-	-
197711	Motor crankcase breather tube lock screw .....	1	1	1	1	1
197761	Motor crankcase breather tube seal .....	1	1	1	1	1
207994	Motor crankcase link .....	-	-	-	2	2
5434	Motor crankcase link screw 1/4-28 x 1-5/8" hex. hd. ....	-	-	-	2	2
5502	Lockwasher 1/4" .....	-	-	-	2	2
7004	Nut 1/4-28 .....	-	-	-	2	2
221381	Motor crankcase link ball .....	-	-	-	1	1
5510	Lockwasher 1/2" .....	-	-	-	1	1
7008	Nut 1/2-20 .....	-	-	-	2	2
209054	Motor crankcase link ball insulator .....	-	-	-	2	2
221369	Motor crankcase link bracket .....	-	-	-	1	1
7891	Motor crankcase link bracket screw 3/8-24 x 2-3/8" hex. hd. (Supersedes 6269) .....	-	-	-	2	-
5506	Lockwasher 3/8" .....	-	-	-	2	2
7006	Nut 3/8-24 .....	-	-	-	2	2
197818	Motor crankcase oil filler and breather bracket .....	1	1	1	1	1
6098	Retaining screw 3/8-24 x 1-3/8" hex. hd. ....	2	2	2	2	2
5506	Lockwasher 3/8" .....	2	2	2	2	2
3877	Plain washer 3/8" .....	2	2	2	2	2
197763	Gasket .....	1	1	1	1	1
197828	Motor crankcase oil filler cap .....	1	1	1	1	1
201936	Motor crankcase oil filler and neck assembly .....	1	1	1	-	-
223779	Motor crankcase oil filler and neck assembly .....	-	-	-	1	1
201059	Motor crankcase oil gauge connection .....	1	1	1	-	-
223980	Motor crankcase oil gauge connection .....	-	-	-	1	-
7003	Motor crankcase oil gauge binding post nut .....	-	-	-	1	-
5935	Motor crankcase oil gauge binding post lockwasher .....	-	-	-	1	-
203016	Motor crankcase oil gauge and float assembly (Prior to Frame No. 901201) .....	1	1	-	-	-
210298	Motor crankcase oil gauge and float assembly (After Frame No. 901200) .....	-	1	1	-	-
223919	Motor crankcase oil gauge and float assembly .....	-	-	-	1	-
197649	Retaining screw 5/16-18 x 5/8" .....	2	2	2	2	-
5504	Lockwasher 5/16" std. ....	2	2	2	2	-
201058	Motor crankcase oil gauge connection bushing .....	1	1	1	1	-
111192	Gasket 5/8" annular .....	1	1	1	1	-
7003	Nut No. 10-32 .....	4	4	4	4	-
5500	Lockwasher .....	2	2	2	2	-
225250	Motor crankcase oil pressure gauge connection .....	-	-	-	1	-

**MOTOR CRANKSHAFT**

202816	Motor crankshaft bearing No. 1 assembly .....	1	1	1	1	1
202817	Motor crankshaft bearing No. 2 and No. 3 assembly .....	2	2	2	2	2
202818	Motor crankshaft bearing No. 4 assembly .....	1	1	1	1	1
203024	Motor crankshaft bearing cap No. 4 .....	1	1	1	-	-
221205	Motor crankshaft bearing cap No. 4 .....	-	-	-	1	1
203023	Motor crankshaft bearing cap No. 2 and No. 3 .....	2	2	2	-	-
221204	Motor crankshaft bearing cap No. 2 and No. 3 .....	-	-	-	2	2
203022	Motor crankshaft bearing cap No. 1 .....	1	1	1	-	-
216389	Motor crankshaft bearing cap No. 1 .....	-	-	-	1	1
197709	Screw 1/2-20 x 2-15/16" (Prior to Motor No. 900310).	8	-	-	-	-
6186	Stud 1/2" spec. (After Motor No. 900309) .....	8	8	8	8	8
201068	Washer (Prior to Motor No. 900309) .....	8	-	-	-	-

Piece No.	Name	No. Required				
		905 906	1005 1006	1107 1108	1207 1208	1407 1408
158669	Washer (After Motor No. 900309) .....	8	8	8	8	8
120813	Lockwire 16" long (Prior to Motor No. 900310) .....	4	-	-	-	-
7108	Nut 1/2-20 castle (After Motor No. 900309) .....	8	8	8	8	8
4291	Cotter pin 3/32 x 3/4" (After Motor No. 900309) ....	8	8	8	8	8
201887	Motor crankshaft bearing No. 4 cork seal .....	2	2	2	2	2
203675	Motor crankshaft and counterweight assembly .....	1	1	1	-	-
219704	Motor crankshaft and counterweight assembly .....	-	-	-	1	1
203042	Motor crankshaft bearing dowel .....	4	4	4	4	4
203284	Motor crankshaft fan pulley .....	1	-	-	-	-
209072	Motor crankshaft fan pulley .....	-	1	1	-	-
221086	Motor crankshaft fan pulley .....	-	-	-	1	1
197700	Motor crankshaft fan pulley screw assembly .....	1	1	1	-	-
221498	Motor crankshaft fan pulley screw .....	-	-	-	1	1
147241	Motor crankshaft fan pulley screw pin .....	-	-	1	-	-
197782	Motor crankshaft key .....	1	1	1	1	1
197657	Motor crankshaft oil seal .....	1	1	1	1	1
197698	Motor crankshaft spacer .....	1	1	1	-	-
202876	Motor crankshaft sprocket .....	1	1	1	1	1
197697	Motor crankshaft thrust plate .....	1	1	1	1	1
197696	Motor crankshaft thrust plate shim .002 .....	1	1	1	1	1
197695	Motor crankshaft thrust plate shim .005 .....	x	x	x	x	x
201910	Motor crankshaft thrust plate shim 1/32" .....	x	x	x	x	x
5537	Dowel 5/16 x 15/16" .....	1	1	1	1	1

## MOTOR CYLINDER

202788	Motor cylinder and piston assembly std. ....	1	1	1	-	-
225062	Motor cylinder and piston assembly std. ....	-	-	-	1	1
202789	Motor cylinder and piston assembly oversize .....	1	1	1	-	-
225063	Motor cylinder and piston assembly oversize .....	-	-	-	1	1
197730	Motor cylinder end plate-rear .....	1	1	1	-	-
219948	Motor cylinder end plate-rear .....	-	-	-	1	1
197779	Motor cylinder end plate-rear gasket .....	1	1	1	1	1
7804	Screw 5/16-18 x 3/4" .....	6	6	6	6	6
5504	Lockwasher 5/16" .....	6	6	6	6	6
3874	Plain washer 5/16" .....	6	6	6	6	6
203059	Motor cylinder end plate rear cork seal .....	1	1	1	-	-
201055	Motor cylinder end plate rear cork seal retainer .....	1	1	1	-	-
203783	Motor cylinder head-left and core hole plug assembly (6.00 to 1) (Iron) .....	1	1	1	-	-
203784	Motor cylinder head-right and core hole plug assembly (6.00 to 1) (Iron) .....	1	1	1	-	-
216851	Motor cylinder head-left and core hole plug assembly (6.00 to 1) (Alum.) .....	-	-	1	-	-
216852	Motor cylinder head-right and core hole plug assembly (6.00 to 1) (Alum.) .....	-	-	1	-	-
216851	Motor cylinder head-left and core hole plug assembly (6.25 to 1 ratio) .....	-	-	-	1	1
216852	Motor cylinder head-right and core hole plug assembly (6.25 to 1 ratio) .....	-	-	-	1	1
225908	Motor cylinder head-left and core hole plug assembly (6.00 to 1 ratio) .....	-	-	-	1	1
225909	Motor cylinder head-right and core hole plug assembly (6.00 to 1 ratio) .....	-	-	-	1	1
228653	Motor cylinder head-left and core hole plug assembly (7.00 to 1 ratio) .....	-	-	-	1	1
228654	Motor cylinder head-right and core hole plug assembly (7.00 to 1 ratio) .....	-	-	-	1	1

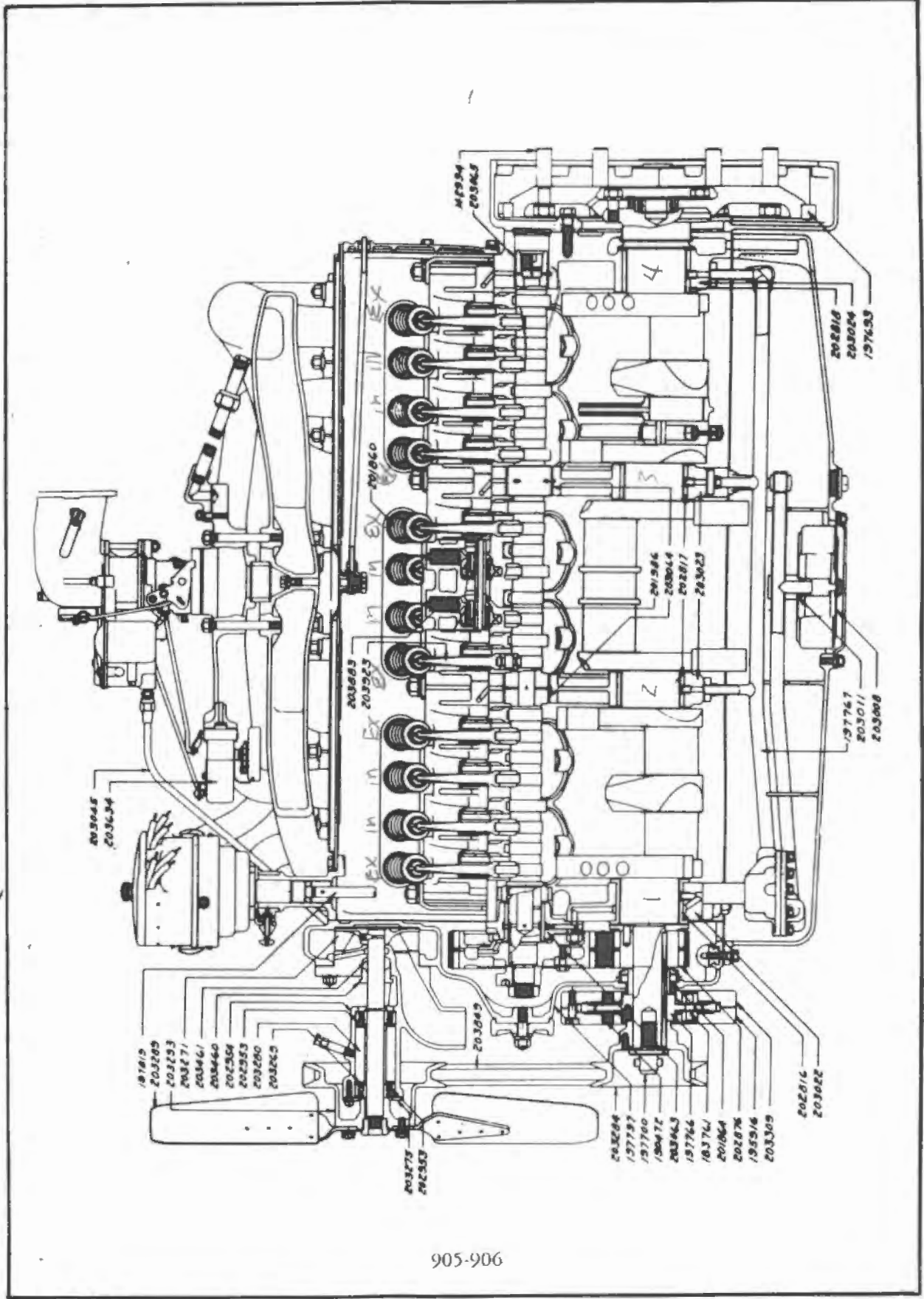



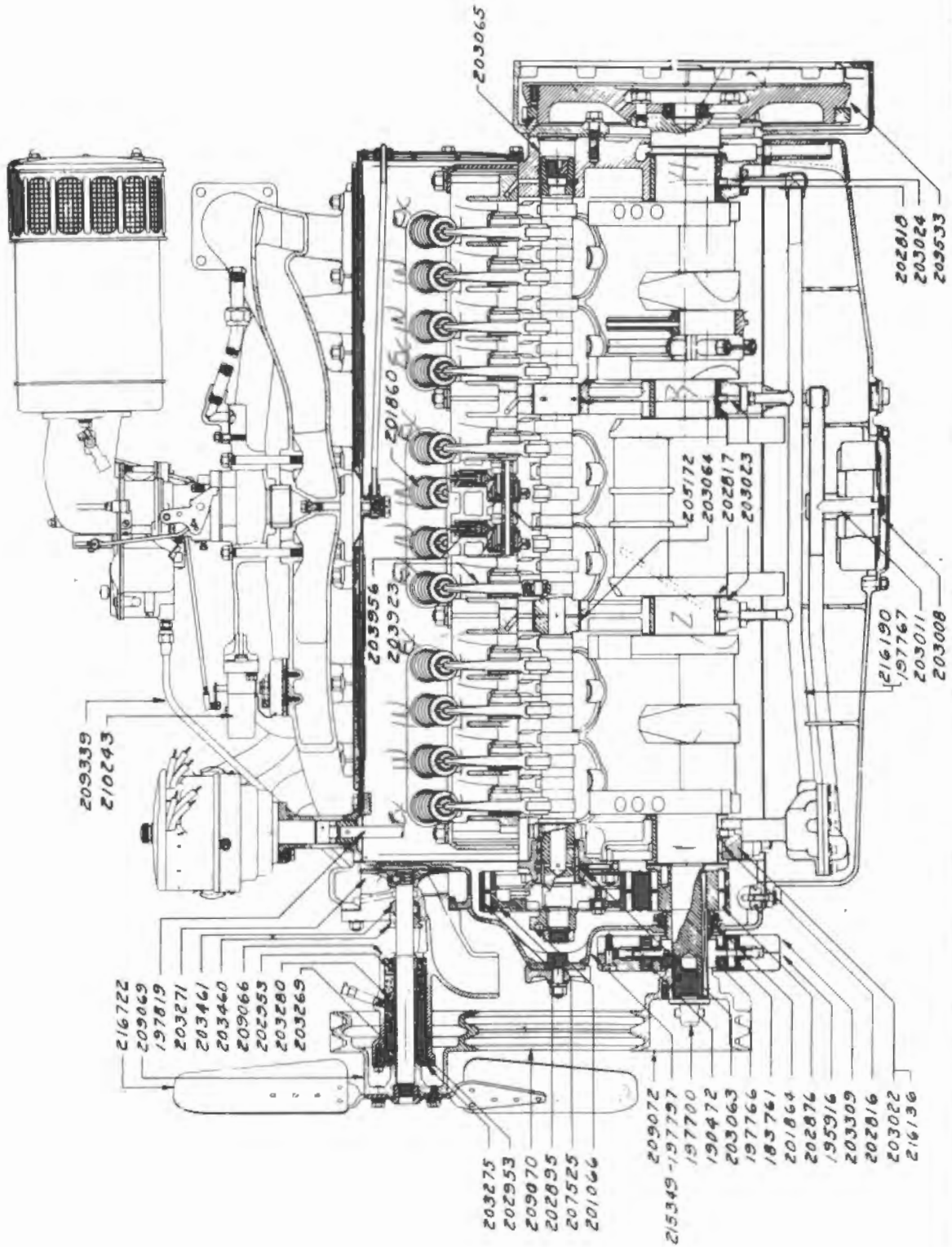

1005-1006

SERVICE PARTS LIST—PACKARD TWELVE

Motor Distributor 101

Piece Nbr.	Name	No. Required				
		905 906	1005 1006	1107 1108	1207 1208	1407 1408
219010	Motor cylinder head-left and core hole plug assembly (6.8 to 1) (Alum.) .....	-	-	1	-	-
219011	Motor cylinder head-right and core hole plug assembly (6.8 to 1) (Alum.) .....	-	-	1	-	-
77748	Motor cylinder head core hole plug .....	4	4	4	4	4
197821	Motor cylinder head gasket .....	2	2	2	2	2
216849	Motor cylinder head gasket (Used with 6.00 to 1 and 6.8 to 1) (Ratio head) .....	-	-	2	-	-
6308	Motor cylinder head stud-intermediate 1/2 x 2-7/8" .....	14	14	14	28	28
6143	Motor cylinder head stud-long 1/2 x 4" .....	14	14	14	14	14
6142	Motor cylinder head stud-short 1/2 x 2-1/4" .....	14	14	14	-	-
6308	Motor cylinder head stud-short 1/2 x 2-7/8" (Used with 6.00 to 1 head) .....	-	-	14	-	-
7208	Nut 1/2" blind 1" high .....	42	-	-	-	-
203874	Nut 1/2-20 blind 3/4" high .....	42	42	42	42	42
201068	Washer 1/2" plain .....	38	38	38	-	-
213902	Washer (Used with 6.00 to 1 and 6.8 to 1 ratio head)	-	-	38	38	38
3884	Washer .....	8	8	8	8	8
203452	Motor cylinder head water outlet flange-left .....	1	1	1	-	-
221951	Motor cylinder head water outlet flange-left .....	-	-	-	1	1
203453	Motor cylinder head water outlet flange-right .....	1	1	1	-	-
221950	Motor cylinder head water outlet flange-right .....	-	-	-	1	1
6169	Stud 5/16 x 1-9/16" .....	4	4	4	4	-
5504	Lockwasher 5/16" .....	4	4	4	4	-
7005	Nut 5/16-24 .....	4	4	4	4	-
6592	Screw 5/16-18 x 1-1/8" hex. hd. ....	-	-	-	4	4
129439	Screw gasket 5/16 annular .....	-	-	-	4	4
203454	Motor cylinder head water outlet flange gasket .....	2	2	2	2	2
203976	Motor cylinder water jacket drain cock .....	2	2	2	2	2
5422	Motor cylinder water jacket drain plug .....	2	-	-	-	-
197790	Motor cylinder water jacket plate .....	2	2	2	2	2
197791	Gasket .....	2	2	2	2	2
6184	Screw 5/16-18 x 5/8" hex. hd. ....	56	54	54	-	-
6465	Screw 5/16-18 x 5/8" hex. hd. ....	-	-	-	54	49
209713	Washer .....	-	56	56	56	56
205981	Motor cylinder water jacket plate to expansion tank screw .....	-	2	2	-	-
3908	Washer 5/16" .....	-	2	2	-	-
205981	Motor cylinder water jacket plate to instrument board oil pressure gauge tube lower assembly clip screw ....	-	-	-	2	3

MOTOR DISTRIBUTOR

207730	Motor distributor .....	-	1	1	-	-
221011	Motor distributor .....	-	-	-	1	1
203012	Motor distributor .....	1	-	-	-	-
207731	Motor distributors (Used with 6.8 to 1 cylinder head) ..	-	-	1	-	-
5787	Motor distributor clamp screw 1/4-28 x 7/8" hex. hd. ...	-	3	3	3	3
205354	Motor distributor clamp screw washer-special .....	-	3	3	3	3
5502	Motor distributor clamp screw lockwasher 1/4" .....	-	3	3	3	3
207804	Motor distributor bracket .....	-	1	1	1	1
197814	Motor distributor bracket .....	1	-	-	-	-
197758	Motor distributor bracket dowel .....	2	2	2	2	2
201069	Motor distributor bracket retaining stud .....	2	2	2	2	2
7006	Nut 3/8-24 plain .....	2	2	2	2	2
5500	Lockwasher 3/8" .....	2	2	2	2	2
3877	Plain washer 3/8" .....	2	2	2	2	2
201063	Motor distributor bracket gasket .....	1	1	1	1	1
0239574	Motor distributor breaker point set .....	1	1	1	-	-
0239575	Motor distributor breaker point set .....	-	-	-	1	1
197813	Motor distributor drive shaft assembly .....	1	1	1	1	1

Piece No	Name	No. Required				
		905 906	1005 1006	1107 1108	1207 1208	1407 1408
197652	Motor distributor drive shaft lock ring .....	1	1	1	1	1
190550	Motor distributor lock plate .....	1	-	-	-	-
5701	Screw 1/4-28 x 9/16" Flat Head .....	3	-	-	-	-
190552	Motor distributor lock plunger .....	1	-	-	-	-
190553	Motor distributor lock plunger body .....	1	-	-	-	-
5806	Lockwasher 7/16" Everlock .....	1	-	-	-	-
191073	Motor distributor lock plunger body nut .....	1	-	-	-	-
190545	Motor distributor lock plunger knob .....	1	-	-	-	-
190554	Motor distributor lock plunger spring .....	1	-	-	-	-
190551	Motor distributor lock ring .....	1	-	-	-	-
7894	Screw 1/4-28 x 1-7/16" hex. hd. ....	1	-	-	-	-
5502	Lockwasher 1/4" .....	1	-	-	-	-
7004	Nut 1/4-28 plain .....	1	-	-	-	-

### MOTOR DISTRIBUTOR

(Electric Auto-Lite No. IGO-4001)

The following parts are listed with the manufacturers' piece numbers and are to be ordered by these numbers. Dealers should order these parts through their distributor.

CA-35	No. 10-32 Nut .....	4	4	4	-	-
GK-98	Distributor drive rivet .....	1	1	1	-	-
IG-90	Thrust washer .....	1	1	1	-	-
IG-644	Distributor drive coupling .....	1	1	1	-	-
IGB-162	Thrust washer .....	1	1	1	-	-
IGL-7	Terminal insulation .....	2	2	2	-	-
IGL-8	Terminal post No. 10-32 .....	2	2	2	-	-
IGL-9	Insulation washer .....	2	2	2	-	-
IGL-10	Insulation bushing .....	2	2	2	-	-
IGL-36	Distributor cap nut .....	1	1	1	-	-
IGL-40	No. 10-32 nut .....	2	2	2	-	-
IGM-26	Oil wick .....	1	1	1	-	-
IGM-2002LA	Drive shaft and governor assembly .....	1	1	1	-	-
IG-2456A	Weight assembly .....	2	2	2	-	-
IG-776	Weight spring .....	2	2	2	-	-
IGM-1002L	Drive shaft assembly .....	1	1	1	-	-
IGO-27	Governor control spring .....	2	2	2	-	-
IGO-30	Distributor cap cover .....	1	1	1	-	-
IGO-1003	Distributor cap assembly .....	1	1	1	-	-
IA-213	Contact spring .....	1	1	1	-	-
IA-218	Contact spring plunger .....	1	1	1	-	-
IGO-1016	Rotor assembly .....	1	1	1	-	-
IA-213	Contact spring .....	1	1	1	-	-
IG-514	Contact spring plunger .....	1	1	1	-	-
IGO-1033	Breaker cam oiler .....	1	1	1	-	-
IGO-2001	Distributor base assembly .....	1	1	1	-	-
IG-511	Name plate .....	1	1	1	-	-
IG-579A	Absorbent bronze bearing .....	2	2	2	-	-
IGO-1020	Distributor cap spring and bracket assembly .....	2	2	2	-	-
IGO-20	Distributor cap spring bracket .....	2	2	2	-	-
IGO-21	Hinge pin .....	2	2	2	-	-
IGO-50	Distributor cap spring .....	2	2	2	-	-
SA-31	Felt wick .....	1	1	1	-	-
X-474	1/4" oiler press in elbow .....	1	1	1	-	-
2X-908	No. 6-32 x 1/4" fill. hd. screw .....	4	4	4	-	-
X-1025	No. 6 lockwasher .....	4	4	4	-	-
2X-1042	No. 12 x 3/16" escutcheon pin .....	2	2	2	-	-

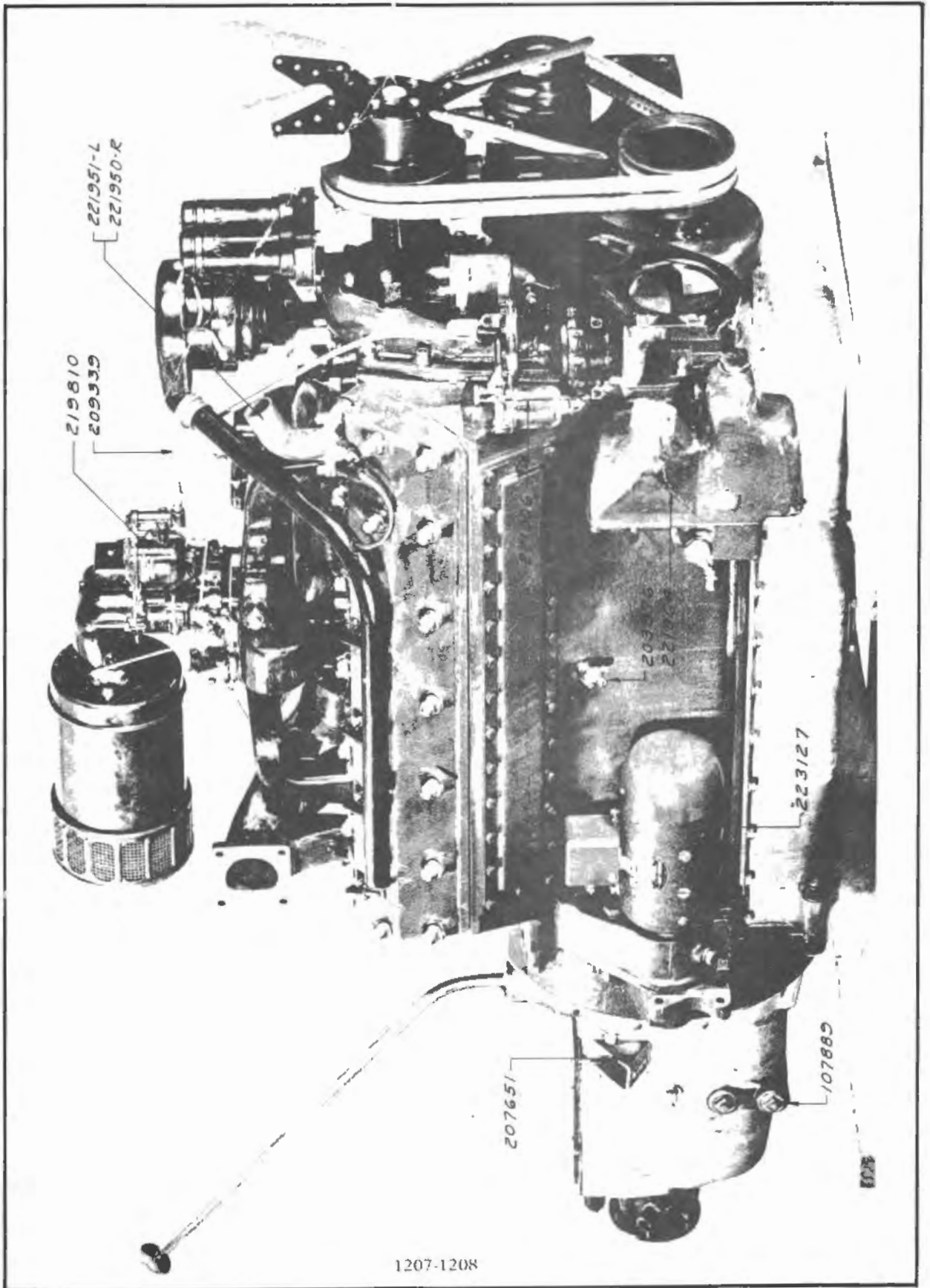

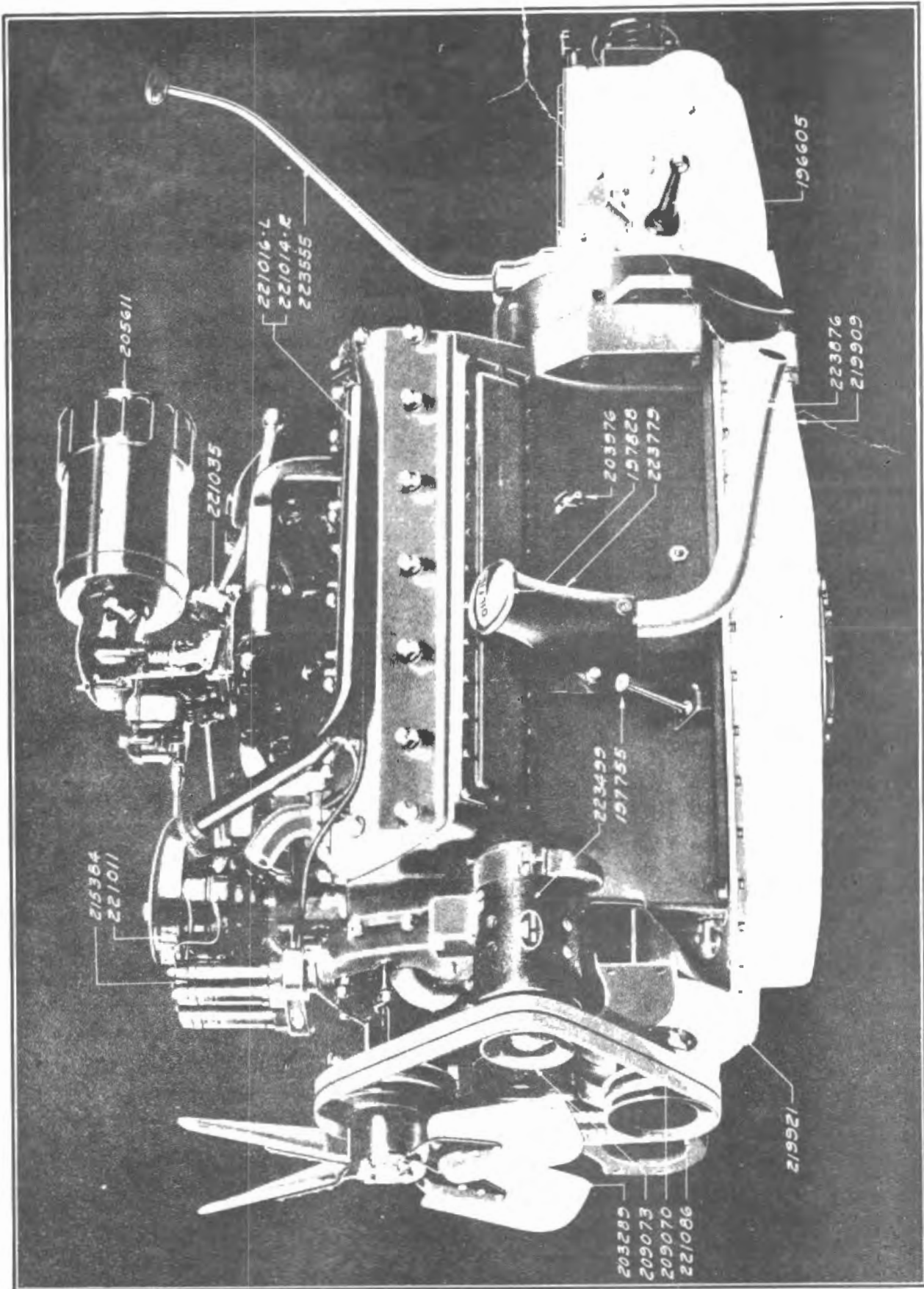

1207-1208

Service Parts List - Packard Twelve

Piece No.	Name	No. Required				
		905 906	1005 1006	1107 1108	1207 1208	1407 1408
IGO-2004	Base plate assembly .....	1	1	1	-	-
GK-151A	Plain steel washer .....	1	1	1	-	-
IA-131	Breaker arm spring clip .....	2	2	2	-	-
IG-1839A	Breaker point .....	1	1	1	-	-
IG-2671A	Condenser assembly .....	1	1	1	-	-
IG-2671E	Condenser assembly .....	1	1	1	-	-
IGB-3664	Breaker arm assembly .....	2	2	2	-	-
IGL-1012	Breaker sub plate assembly .....	1	1	1	-	-
IB-23	Breaker point lock nut .....	1	1	1	-	-
IB-24	Breaker point screw .....	1	1	1	-	-
IGO-14	Primary connector assembly .....	1	1	1	-	-
IGB-132	Terminal .....	1	1	1	-	-
IGL-5	Terminal .....	1	1	1	-	-
IGO-15	Primary connector assembly .....	1	1	1	-	-
IGB-132	Terminal .....	1	1	1	-	-
IGL-6	Terminal .....	1	1	1	-	-
IGO-1004	Breaker plate part assembly .....	1	1	1	-	-
X-194	No. 6 Lockwasher .....	2	2	2	-	-
X-195	No. 8 Lockwasher .....	2	2	2	-	-
8X-323	No. 6-32 x 5/16" rnd. hd. screw .....	2	2	2	-	-
8X-350	No. 8 Plain washer .....	2	2	2	-	-
X-537	No. 10 Lockwasher .....	1	1	1	-	-
8X-870	No. 10-32 x 5/16" fill. hd. screw .....	1	1	1	-	-
8X-873	No. 6-32 x 5/16" fill. hd. screw .....	2	2	2	-	-
IGO-1028	Oiler assembly .....	1	1	1	-	-
IGO-28	Oil wick .....	1	1	1	-	-
IGB-209	Breaker arm spring .....	2	2	2	-	-
X-1012	No. 6 Lockwasher .....	3	3	3	-	-
8X-1348	No. 6-32 x 5/16" fill. hd. screw .....	1	1	1	-	-
8X-1349	No. 6-32 x 3/8" fill. hd. screw .....	2	2	2	-	-
IGO-2024L	Breaker camshaft assembly .....	1	1	1	-	-
DB-13	Flat felt guard .....	1	1	1	-	-
IGO-48	1/2" special lockwasher .....	1	1	1	-	-
IGL-26	1/2-20 nut .....	1	1	1	-	-
IGL-38	Felt washer .....	1	1	1	-	-
IGL-90	Spacing washer .....	2	2	2	-	-
IGO-47	Stop plate .....	1	1	1	-	-
IGO-1042L	Cam and shaft .....	1	1	1	-	-
X-367	Ball bearing .....	1	1	1	-	-
8X-119	No. 10-32 x 1/2" fill. hd. screw .....	2	2	2	-	-
2X-183	No. 10 brass washer .....	3	3	3	-	-
X-195	No. 8 Lockwasher .....	1	1	1	-	-
X-196	No. 10 Lockwasher .....	20	20	20	-	-
8X-350	No. 8 Plain washer .....	1	1	1	-	-
X-400	3/8" elbow oiler .....	1	1	1	-	-
2X-902	No. 10-32 x 3/8" fill. hd. screw .....	12	12	12	-	-
8X-1349	No. 8-32 x 3/8" fill. hd. screw .....	1	1	1	-	-

## MOTOR DISTRIBUTOR

(Electric Auto-Lite No. IGO-4002-A)

The following parts are listed with the manufacturers' piece numbers and are to be ordered by these numbers. Dealers should order these parts through their distributor.

CA-35	No. 10-32 Nut .....	-	-	-	4	4
IG-313	Shaft thrust washer .....	-	-	-	1	1
IG-644	Dist. drive coupling .....	-	-	-	1	1



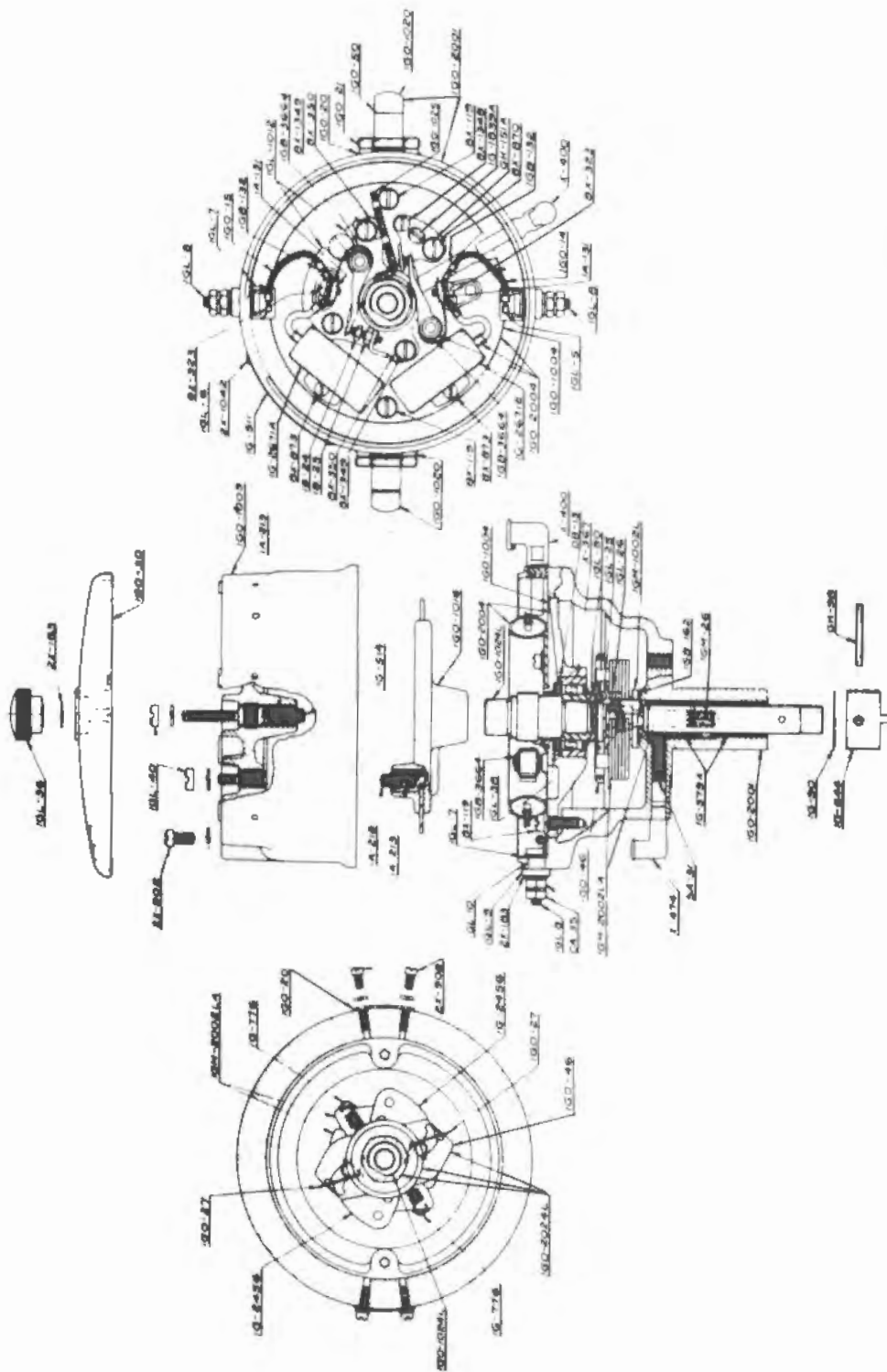

100-400/1  
Fig. 10

100-400/2  
Fig. 11

905-6-1005-6-1107-8

Piece No.	Name	No. Required				
		905 906	1005 1006	1107 1108	1207 1208	1407 1408
IGB-162	Thrust washer .....	-	-	-	1	1
IGB-247	Dist. drive rivet .....	-	-	-	1	1
IGL-7	Terminal Insulation .....	-	-	-	2	2
IGL-8	Terminal post No. 10-32 .....	-	-	-	2	2
IGL-9	Insulating washer .....	-	-	-	2	2
IGL-10	Insulating bushing .....	-	-	-	2	2
IGL-36	Dist. cap nut .....	-	-	-	1	1
IGL-40	No. 10-32 Nut .....	-	-	-	2	2
IGM-26	Oil wick .....	-	-	-	1	1
IGM-2002LA	Drive shaft and Gov. assembly .....	-	-	-	1	1
IGE-29	Weight spring .....	-	-	-	2	2
IG-2322	Weight assembly .....	-	-	-	2	2
IGO-1002L	Drive shaft assembly .....	-	-	-	1	1
IGO-1003	Dist. cap assembly .....	-	-	-	1	1
IA-213	Contact spring .....	-	-	-	1	1
IG-514	Contact spring plunger .....	-	-	-	1	1
IGO-1016	Rotor assembly .....	-	-	-	1	1
IA-213	Contact spring .....	-	-	-	1	1
IA-218	Contact spring plunger .....	-	-	-	1	1
IGO-1028	Oiler assembly .....	-	-	-	1	1
IGO-28	Oil wick .....	-	-	-	1	1
X-400	3/8 Elbow oiler .....	-	-	-	1	1
IGO-1033	Breaker cam oiler .....	-	-	-	1	1
IGO-2001	Dist. base assembly .....	-	-	-	1	1
IG-511	Name plate .....	-	-	-	1	1
IG-579A	Absorbent bronze bearing .....	-	-	-	2	2
IGO-1020	Dist. cap spring and bracket assembly .....	-	-	-	2	2
IGO-20	Dist. cap spring bracket .....	-	-	-	2	2
IGO-21	Hinge pin .....	-	-	-	2	2
IGO-50	Dist. cap spring .....	-	-	-	2	2
SA-31	Felt wick .....	-	-	-	1	1
X-474	1/4 Oiler--press in elbow .....	-	-	-	1	1
2X-908	No. 6-32 x 1/4" fill. hd. screw .....	-	-	-	4	4
X-1025	No. 6 Lockwasher .....	-	-	-	4	4
2X-1042	No. 13 x 3/16 Escutcheon pin .....	-	-	-	2	2
IGO-2004	Breaker plate assembly .....	-	-	-	1	1
GK-151A	Plain steel washer .....	-	-	-	1	1
IA-131	Breaker arm spring clip .....	-	-	-	2	2
IG-2671A	Condenser assembly .....	-	-	-	1	1
IG-2671E	Condenser assembly .....	-	-	-	1	1
IGO-14	Primary connector assembly .....	-	-	-	1	1
IGB-132	Terminal .....	-	-	-	1	1
IGL-5	Terminal .....	-	-	-	1	1
IGO-15	Primary connector assembly .....	-	-	-	1	1
IGB-132	Terminal .....	-	-	-	1	1
IGL-6	Terminal .....	-	-	-	1	1
IGO-1004	Breaker plate part assembly .....	-	-	-	1	1
IGO-1013	Breaker sub plate assembly .....	-	-	-	1	1
IB-23	Breaker point lock nut .....	-	-	-	1	1
IGP-33	Breaker point screw .....	-	-	-	1	1
AGO-1034	Breaker point .....	-	-	-	1	1
IGP-3028	Breaker arm assembly .....	-	-	-	2	2
IGP-30	Breaker arm spring .....	-	-	-	2	2
X-194	No. 6 Lockwasher .....	-	-	-	2	2
X-195	No. 8 Lockwasher .....	-	-	-	2	2
8X-323	No. 6-32 x 5/16" rnd. hd. screw .....	-	-	-	2	2
8X-350	No. 8 Plain washer .....	-	-	-	2	2
X-537	No. 10 Lockwasher .....	-	-	-	1	1
8X-870	No. 10-32 x 5/16" fill. hd. screw .....	-	-	-	1	1



SERVICE PARTS LIST—PACKARD TWELVE

Motor Flywheel 109

Piece No.	Name	No. Required				
		905 906	1005 1006	1107 1108	1207 1208	1407 1408
8X-873	No. 6-32 x 3/16" fill. hd. screw .....	-	-	-	3	3
X-1012	No. 6 Lockwasher .....	-	-	-	3	3
8X-1349	No. 8-32 x 3/8" fill. hd. screw .....	-	-	-	2	2
IG0-2024LB	Breaker cam shaft assembly .....	-	-	-	1	1
DB-13	Flat felt guard .....	-	-	-	1	1
IGL-26	1/2-20 Nut .....	-	-	-	1	1
IGL-38	Felt washer .....	-	-	-	1	1
IGL-90	Spacing washer .....	-	-	-	1	1
IG0-47B	Stop plate .....	-	-	-	1	1
IG0-48	1/2 Special lockwasher .....	-	-	-	1	1
IG0-1024L	Cam and shaft .....	-	-	-	1	1
X-367	Ball bearing .....	-	-	-	1	1
8X-119	No. 10-32 x 1/2" fill. hd. screw .....	-	-	-	2	2
2X-183	No. 10 Brass washer .....	-	-	-	3	3
X-195	No. 8 Lockwasher .....	-	-	-	1	1
X-196	No. 10 Lockwasher .....	-	-	-	20	20
8X-350	No. 8 Plain washer .....	-	-	-	1	1
2X-902	No. 10-32 x 3/8" fill. hd. screw .....	-	-	-	12	12
X-1012	No. 6 Lockwasher .....	-	-	-	1	1
8X-1348	No. 6-32 x 5/16" fill. hd. screw .....	-	-	-	1	1
8X-1349	No. 8-32 x 3/8" fill. hd. screw .....	-	-	-	1	1

MOTOR FAN

228675	Motor fan (Supersedes 203289) .....	1	1	1	1	1
5449	Screw 5/16-24 x 3/4" hex. hd. ....	4	4	4	4	4
5504	Lockwasher 5/16" .....	4	4	4	4	4
203849	Motor fan belt .....	1	-	-	-	-
209070	Motor fan belt .....	-	2	2	2	2
203287	Motor fan pulley nut .....	1	1	1	1	1
203288	Motor fan pulley nut lock .....	1	1	1	1	1
5783	Key No. 7 Woodruff .....	1	1	1	-	-
3874	Motor fan retaining screw washer .....	4	4	4	4	4

MOTOR FLYWHEEL

209533	Motor flywheel assembly .....	-	1	1	-	-
197693	Motor flywheel assembly .....	1	-	-	-	-
219808	Motor flywheel assembly .....	-	-	-	1	1
142934	Motor flywheel clutch driving stud .....	6	-	-	-	-
7009	Nut 9/16" .....	6	-	-	-	-
5512	Lockwasher 9/16" .....	6	-	-	-	-
197260	Motor flywheel flange screw .....	6	6	6	6	6
5510	Lockwasher 1/2" .....	6	6	6	6	6
197723	Motor flywheel housing .....	1	1	1	-	-
213737	Motor flywheel housing .....	-	-	-	1	1
197750	Motor flywheel housing to crankcase dowel .....	2	2	2	2	2
6049	Motor flywheel housing to crankcase screw 9/16-18 x 2" hex. hd. ....	2	2	2	2	2
6051	Motor flywheel housing to crankcase screw 9/16-18 x 3-7/8" hex. hd. ....	4	4	4	-	-
7885	Motor flywheel housing to crankcase screw 7/16-20 x 1-3/8" hex. hd. ....	3	3	3	3	3
5842	Motor flywheel housing to crankcase screw 9/16-18 x 3-3/4" hex. hd. ....	-	-	-	4	4
5512	Lockwasher 9/16" .....	6	6	6	6	6
5508	Lockwasher 7/16" .....	3	3	3	3	3

Piece No.	Name	No. Required				
		905 906	1005 1006	1207 1108	1208	1407 1408
6437	Motor flywheel housing to oil pan screw 9/16-18 x 4" hex. hd. ....	-	-	-	2	2
7009	Nut 9/16-18 .....	-	-	-	2	2
5512	Lockwasher 9/16" .....	-	-	-	2	2
197749	Motor flywheel housing timing indicator .....	1	1	1	1	1
7801	Screw 1/4-28 x 1/2" hex. hd. ....	2	2	2	2	2
5502	Lockwasher 1/4" std. ....	2	2	2	2	2
6022	Motor flywheel housing to transmission case stud-long ..	10	10	8	8	8
219050	Motor flywheel housing to transmission case stud .....	-	-	2	2	2
6106	Motor flywheel housing to transmission case stud-short ..	2	2	2	2	2
7006	Nut 3/8-24 .....	-	12	12	12	12
5506	Lockwasher 3/8" .....	-	12	12	12	12

MOTOR FUEL PUMP

207384	Motor fuel pump assembly .....	-	1	1	-	-
201057	Motor fuel pump assembly .....	1	-	-	-	-
221006	Motor fuel pump assembly .....	-	-	-	1	1
6128	Stud 5/16" S.M. special .....	2	-	-	-	-
6169	Stud 5/16" special .....	-	2	2	2	2
7005	Nut 5/16-24 plain .....	2	2	2	2	2
5504	Lockwasher 5/16" .....	2	2	2	2	2
3874	Plain washer 5/16" .....	2	2	2	2	2
184471	Motor fuel pump gasket .....	1	-	-	-	-
207830	Motor fuel pump gasket .....	-	1	1	1	1
203045	Motor fuel pump to carburetor tube assembly .....	1	-	-	-	-
209339	Motor fuel pump to carburetor tube assembly .....	-	1	1	1	1
6262	Nut 5/16" flared tube inverted (Weatherhead) .....	-	1	1	1	1
5867	Union nut 5/16" .....	-	1	1	1	1
5466	Union nut .....	2	-	-	-	-
5444	Union connection .....	1	1	1	1	1
225610	Motor fuel pump to carburetor tube insulator .....	-	-	-	1	1
215177	Motor fuel pump diaphragm spring .....	-	1	1	1	1
201066	Motor fuel pump eccentric .....	1	1	1	1	1
3987	Motor fuel pump eccentric key .....	1	1	1	1	1
167638	Motor fuel pump inlet elbow .....	1	-	-	-	-
209332	Motor fuel pump inlet elbow .....	-	1	1	1	1
167638	Motor fuel pump outlet elbow .....	1	-	-	-	-
6273	Motor fuel pump outlet elbow (5/16" flared tube inverted) (Weatherhead) .....	-	1	1	1	1

MOTOR FUEL PUMP

The following parts are listed with the manufacturers' piece numbers and are to be ordered by these numbers. Dealers should order these parts through their distributor.

SW-1480	1/8" pipe plug .....	x	-	-	-	-
SW-12476	1/4" lockwasher .....	x	-	-	-	-
SW-12490	1/4-28 hexagon nut .....	x	-	-	-	-
SW-13261	Air dome screw .....	x	-	-	-	-
SW-41679	Cork gasket .....	x	-	-	-	-
SW-60639	Hexagon washer .....	x	-	-	-	-
SW-60644	Valve spring .....	x	-	-	-	-
SW-60649	Filtering screen .....	x	-	-	-	-
SW-62065	Lever fulcrum shaft .....	x	-	-	-	-

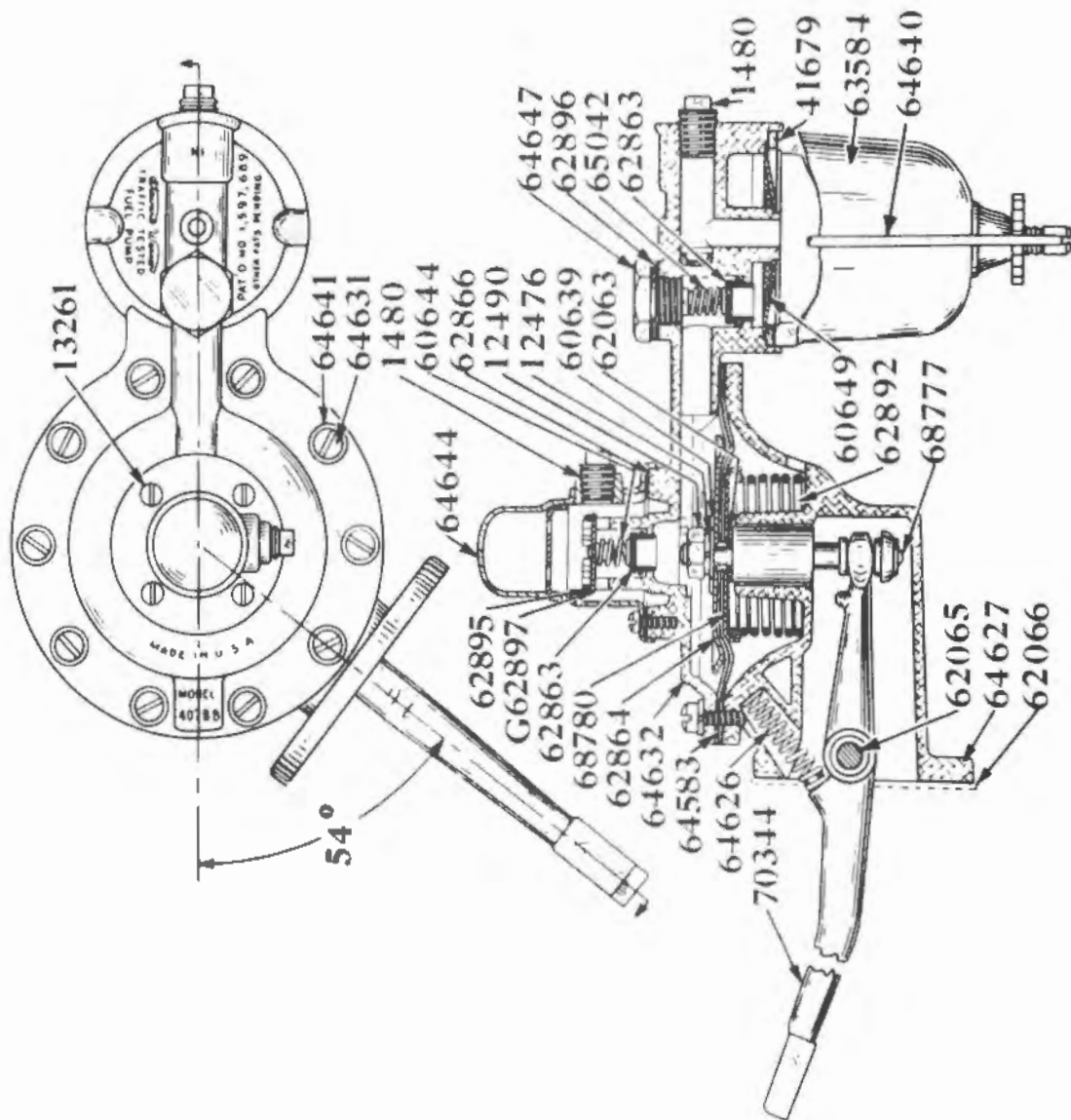

905-906



Piece No	Name	No. Required				
		905 906	1005 1006	1107 1108	1207 1208	1407 1408
SW-62863	Valve .....	X	-	-	-	-
SW-62864	Upper diaphragm plate .....	X	-	-	-	-
SW-62866	Cork gasket (Air dome) .....	X	-	-	-	-
SW-62892	Spring (Discharge) .....	X	-	-	-	-
SW-62895	Snap ring .....	X	-	-	-	-
SW-62896	Washer (Valve nut) .....	X	-	-	-	-
SW-G-62897	Stop pin and bridge assembly .....	X	-	-	-	-
SW-63584	Glass bowl .....	X	-	-	-	-
SW-64583	Diaphragm (4-62862 and Envelope - Service only) .....	X	-	-	-	-
SW-64626	Spring (lever) .....	X	-	-	-	-
SW-64627	Body .....	X	-	-	-	-
SW-64631	Cover lockwasher .....	X	-	-	-	-
SW-64632	Cover and valve bushing assembly .....	X	-	-	-	-
SW-64640	Chin strap assembly .....	X	-	-	-	-
SW-64641	Cover screw .....	X	-	-	-	-
SW-64644	Air dome .....	X	-	-	-	-
SW-64647	Valve nut .....	X	-	-	-	-
SW-65042	Inlet valve spring .....	X	-	-	-	-
SW-68777	Plunger .....	X	-	-	-	-
SW-68780	Lower diaphragm plate .....	X	-	-	-	-
SW-70344	Lever .....	X	-	-	-	-

MOTOR FUEL PUMP

The following parts are listed with the manufacturers' piece numbers and are to be ordered by these numbers. Dealers should order these parts through their distributor.

AC-854004	Glass bowl .....	-	1	1	-	-
AC-854003	Bowl gasket .....	-	1	1	-	-
AC-854009	Screen .....	-	1	1	-	-
AC-854005	Cowl seat .....	-	1	1	-	-
AC-855763	Bail nut .....	-	1	1	-	-
AC-854016	Bail and screw .....	-	1	1	-	-
AC-855281	Valve plug .....	-	1	1	-	-
AC-855282	Valve plug gasket .....	-	2	2	-	-
AC-856270	Valve spring .....	-	2	2	-	-
AC-855279	Valve .....	-	2	2	-	-
AC-855918	Air dome .....	-	1	1	-	-

MOTOR FUEL PUMP

The following parts are listed with the manufacturers' piece numbers and are to be ordered by these numbers. Dealers should order these parts through their distributor.

AC-1521778	Combination pump .....	-	-	-	X	X
AC-1521034	Air dome .....	-	-	-	X	X
AC-856354	Body .....	-	-	-	X	X
AC-855761	Top cover and valve seat assembly .....	-	-	-	X	X
AC-1521868	Rocker arm .....	-	-	-	X	X
AC-1521283	Rocker arm pin .....	-	-	-	X	X
AC-1521284	Rocker arm washer .....	-	-	-	X	X
AC-856209	Oil seal gasket .....	-	-	-	X	X
AC-856208	Oil seal gasket retainer .....	-	-	-	X	X
AC-855493	Top cover screw .....	-	-	-	X	X

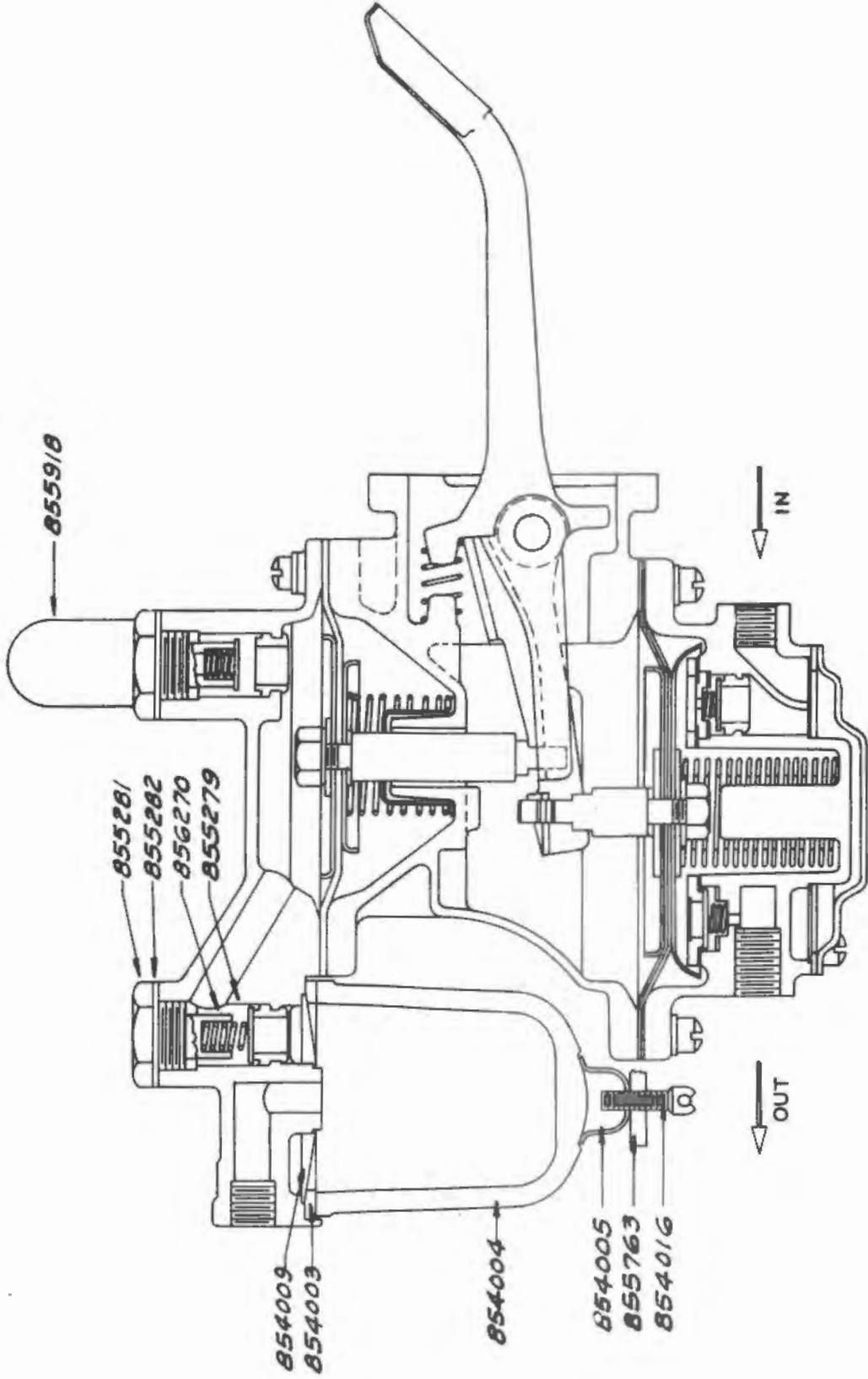

1005-6-1107-8

Piece No.	Name	No. Required				
		905 906	1005 1006	1107 1108	1207 1208	1407 1408
AC-855064	Top cover screw lockwasher .....	-	-	-	X	X
AC-1521866	Link .....	-	-	-	X	X
AC-1521036	Valve plug .....	-	-	-	X	X
AC-855279	Valve .....	-	-	-	X	X
AC-856270	Valve spring .....	-	-	-	X	X
AC-855927	Glass bowl .....	-	-	-	X	X
AC-854003	Bowl gasket .....	-	-	-	X	X
AC-856249	Screen .....	-	-	-	X	X
AC-1521339	Bail assembly .....	-	-	-	X	X
AC-1521337	Bowl seat .....	-	-	-	X	X
AC-1521338	Thumb nut .....	-	-	-	X	X
AC-855389	Diaphragm (5 pieces 855275) .....	-	-	-	X	X
AC-1521429	Pull rod .....	-	-	-	X	X
AC-1521749	Pull rod nut .....	-	-	-	X	X
AC-855274	Upper diaphragm protector .....	-	-	-	X	X
AC-1521720	Lower diaphragm protector .....	-	-	-	X	X
AC-855029	Diaphragm alignment washer .....	-	-	-	X	X
AC-855390	Pull rod lockwasher .....	-	-	-	X	X
AC-855911	Pull rod gasket .....	-	-	-	X	X
AC-1521427	Rocker arm spring .....	-	-	-	X	X
AC-1521491	Diaphragm spring .....	-	-	-	X	X
AC-1521150	Body .....	-	-	-	X	X
AC-855493	Body screw .....	-	-	-	X	X
AC-855064	Body screw lockwasher .....	-	-	-	X	X
AC-856349	Diaphragm (5 pieces 856218) .....	-	-	-	X	X
AC-856358	Diaphragm spring .....	-	-	-	X	X
AC-856216	Upper diaphragm protector .....	-	-	-	X	X
AC-856217	Lower diaphragm protector .....	-	-	-	X	X
AC-1521156	Diaphragm alignment washer .....	-	-	-	X	X
AC-1521097	Gasket .....	-	-	-	X	X
AC-1521411	Pull rod .....	-	-	-	X	X
AC-1521749	Pull rod nut .....	-	-	-	X	X
AC-855390	Pull rod nut lockwasher .....	-	-	-	X	X
AC-855911	Pull rod gasket .....	-	-	-	X	X
AC-856222	Bottom cover .....	-	-	-	X	X
AC-132108	Bottom cover screw .....	-	-	-	X	X
AC-856229	Bottom cover gasket .....	-	-	-	X	X
AC-855279	Valve .....	-	-	-	X	X
AC-856223	Valve stop plate .....	-	-	-	X	X
AC-856270	Valve spring .....	-	-	-	X	X
AC-856375	Valve retainer .....	-	-	-	X	X
AC-856373	Valve retainer gasket .....	-	-	-	X	X
AC-856221	Screen .....	-	-	-	X	X
AC-856374	Valve retainer screw .....	-	-	-	X	X
AC-1521867	Link .....	-	-	-	X	X

## MOTOR GEAR COVER

197797	Motor gear cover .....	1	1	-	-	-
215349	Motor gear cover .....	-	-	1	-	-
221003	Motor gear cover .....	-	-	-	1	1
201053	Motor gear cover gasket .....	1	1	1	1	1
6132	Screw 3/8-24 x 1" (After Motor No. 900196) .....	8	-	-	-	-
201865	Stud-long .....	6	6	6	2	2
197804	Stud-short .....	-	8	8	8	8
221004	Stud-lower .....	-	-	-	4	4
7819	Retaining screw-short 3/8-24 x 1" hex. hd. (Prior to Motor No. 900197) .....	8	-	-	-	-
3877	Plain washer 3/8" std. ....	14	14	14	14	14

Piece No.	Name	No. Required				
		905 906	1005 1006	1107 1108	1207 1208	1407 1408
5506	Lockwasher 3/8" std. ....	14	14	14	14	14
7006	Nut 3/8-24 plain .....	14	14	14	14	14
6382	Motor gear cover generator support stud 3/8" .....	-	-	1	-	-
215350	Motor gear cover generator support stud washer .....	-	-	1	-	-
5506	Lockwasher 3/8" plain .....	-	-	1	-	-
7006	Nut 3/8-24 .....	-	-	1	-	-
223747	Motor gear cover motor support bushing .....	-	-	-	2	2
6016	Motor gear cover motor support bushing plate stud 3/8 ..	-	-	-	2	2
7006	Nut 3/8-24 .....	-	-	-	2	2
5506	Lockwasher 3/8" .....	-	-	-	2	2
203198	Motor gear cover timing indicator .....	1	1	1	1	1
5928	Screw 1/4-20 x 5/8" fill. hd. ....	2	2	2	-	-
5502	Lockwasher 1/4" .....	2	2	2	-	-
6014	Motor gear cover timing indicator stud .....	-	-	-	2	2
7004	Nut 1/4-28 .....	-	-	-	2	2
5502	Lockwasher 1/4" .....	-	-	-	2	2
201864	Motor gear cover thrust plate .....	1	1	1	1	1

## MOTOR GENERATOR

98316	Motor generator (Supersedes 209074) .....	1	1	-	-	-
219724	Motor generator (Supersedes 215265) .....	-	-	1	-	-
223499	Motor generator .....	-	-	-	1	-
230430	Motor generator .....	-	-	-	-	1
197825	Motor generator to gear cover stud .....	2	2	2	-	-
7007	Nut 7/16" plain .....	2	2	2	-	-
5508	Lockwasher 7/16" .....	2	2	2	-	-
221042	Motor generator to gear cover stud .....	-	-	-	1	1
7008	Motor generator to gear cover stud nut 1/2-20 .....	-	-	-	1	1
6047	Lockwasher 1/2" Shakeproof extra heavy .....	-	-	-	1	1
3884	Washer 1/2" .....	-	-	-	1	1
219895	Motor generator to gear cover stud washer .....	-	-	-	1	1
219893	Motor generator to gear cover screw-long .....	-	-	-	1	1
5510	Lockwasher 1/2" .....	-	-	-	1	1
201933	Motor generator retaining screw washer .....	1	1	1	-	-
203283	Motor generator pulley .....	1	-	-	-	-
209073	Motor generator pulley .....	-	1	1	1	-
230369	Motor generator pulley .....	-	-	-	-	1
5783	Key No. 7 Woodruff .....	1	1	1	1	1
201948	Lockwasher .....	1	1	1	1	1
201947	Nut 3/4-16 plain special .....	1	1	1	1	1

## MOTOR GENERATOR

(Owen-Dyneto Type CL-1033)

The following parts are listed with the Manufacturers' piece numbers and are to be ordered direct from Owen-Dyneto Corporation, Syracuse, New York, or nearest Service Station.

OD-10L58	Lockwasher No. 8 .....	x	-	-	-	-
OD-14L04	Through bolt lockwasher .....	x	-	-	-	-
OD-14L56	Lockwasher No. 6 .....	x	-	-	-	-
OD-14L60	Lockwasher No. 10 .....	x	-	-	-	-
OD-14N2041	Through bolt nut .....	x	-	-	-	-
OD-20N1580	Brush ring nut .....	x	-	-	-	-
OD-24N1600	Cutout terminal nut .....	x	-	-	-	-
OD-14156004	Regulator terminal screws .....	x	-	-	-	-

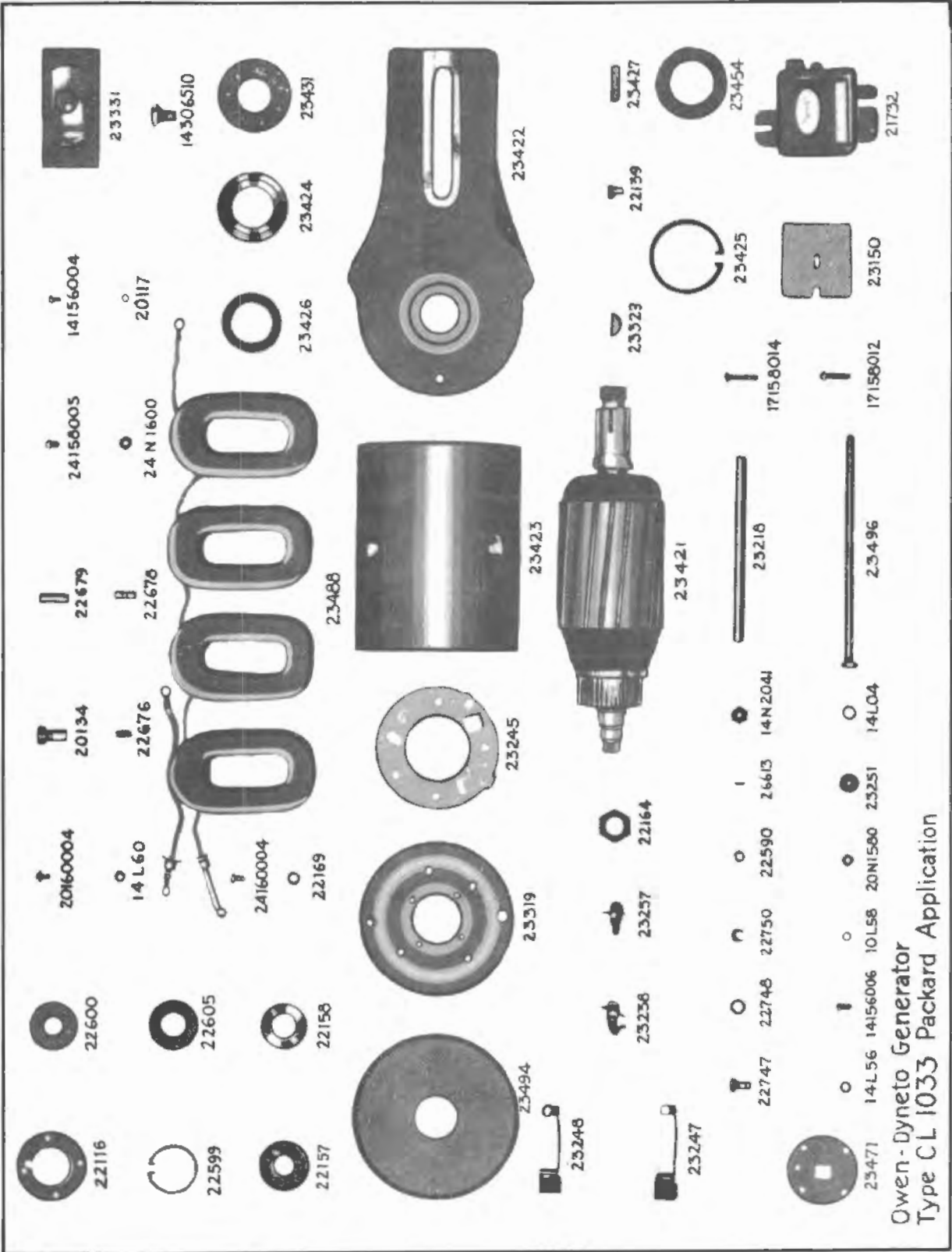

Owen-Dyneto Generator  
Type CL 1033 Packard Application

Piece No.	Name	No. Required				
		905 906	1005 1006	1107 1108	1207 1208	1407 1408
OD-14156006	Commutator and bearing cap screw .....	X	-	-	-	-
OD-14306510	Pole screw .....	X	-	-	-	-
OD-17168012	Brush ring retaining screw (short) .....	X	-	-	-	-
OD-17158014	Brush ring retaining screw (long) .....	X	-	-	-	-
OD-20160004	Brush lead screw .....	X	-	-	-	-
OD-24158005	Commutator end cover screw .....	X	-	-	-	-
OD-24160004	Battery charge regulator screw .....	X	-	-	-	-
OD-20117	Regulator terminal screw lockwasher .....	X	-	-	-	-
OD-20134	Fuse holder .....	X	-	-	-	-
OD-21732	Battery charge regulator and cutout .....	X	-	-	-	-
OD-22116	Commutator end bearing cap gasket .....	X	-	-	-	-
OD-22139	Oiler (DE bearing) .....	X	-	-	-	-
OD-22157	Commutator end felt washer .....	X	-	-	-	-
OD-22158	Commutator end felt washer retainer .....	X	-	-	-	-
OD-22164	Armature shaft nut (CE) .....	X	-	-	-	-
OD-22169	Lockwasher No. 10 special .....	X	-	-	-	-
OD-22590	Shakeproof washer .....	X	-	-	-	-
OD-22599	Commutator end bearing retaining ring .....	X	-	-	-	-
OD-22600	Commutator end bearing .....	X	-	-	-	-
OD-22605	Commutator end felt washer cup .....	X	-	-	-	-
OD-22676	Fuse spring .....	X	-	-	-	-
OD-22678	Fuse .....	X	-	-	-	-
OD-22679	Fuse insulation .....	X	-	-	-	-
OD-22747	Adjusting pinion .....	X	-	-	-	-
OD-22748	Adjusting pinion spring washer .....	X	-	-	-	-
OD-22750	Adjusting pinion washer .....	X	-	-	-	-
OD-23150	Battery charge regulator and cutout insulation .....	X	-	-	-	-
OD-23218	Through bolt insulator .....	X	-	-	-	-
OD-23245	Brush ring .....	X	-	-	-	-
OD-23247	Main brush .....	X	-	-	-	-
OD-23248	Control brush .....	X	-	-	-	-
OD-23251	Third brush advance stop .....	X	-	-	-	-
OD-23257	Brush spring and arm (Control) .....	X	-	-	-	-
OD-23258	Brush spring and arm (Main) .....	X	-	-	-	-
OD-23319	Commutator end housing .....	X	-	-	-	-
OD-23325	Commutator end housing assembly (Not illustrated) ....	X	-	-	-	-
OD-23329	Woodruff key .....	X	-	-	-	-
OD-23331	Pole piece .....	X	-	-	-	-
OD-23421	Armature .....	X	-	-	-	-
OD-23422	Drive end housing .....	X	-	-	-	-
OD-23423	Field frame .....	X	-	-	-	-
OD-23424	Drive end felt washer retainer .....	X	-	-	-	-
OD-23425	Drive end bearing retainer ring .....	X	-	-	-	-
OD-23426	Drive end felt washer .....	X	-	-	-	-
OD-23427	Oil felt wick .....	X	-	-	-	-
OD-23431	Drive end bearing .....	X	-	-	-	-
OD-23454	Drive end bearing cap assembly .....	X	-	-	-	-
OD-23471	Commutator end bearing cap .....	X	-	-	-	-
OD-23488	Field coil assembly .....	X	-	-	-	-
OD-23494	Commutator end cover .....	X	-	-	-	-
OD-23496	Through bolt .....	X	-	-	-	-
OD-26613	Dowel pin (Commutator end housing to frame) .....	X	-	-	-	-



Piece No.	Name	No. Required				
		905 906	1005 1006	1107 1108	1207 1208	1407 1408
<b>MOTOR GENERATOR</b>						
(Owen-Dyneto Type CO-1119 for 1005-1006)						
(Owen-Dyneto Type CO-1166 and CO-1241 for 1107-1108)						
The following parts are listed with the Manufacturers' piece numbers and are to be ordered direct from Owen-Dyneto Corporation, Syracuse, New York, or nearest Service Station.						
OD-14L05	Through bolt lockwasher .....	-	X	X	-	-
OD-14L56	Lockwasher No. 6 .....	-	X	X	-	-
OD-14L58	Lockwasher No. 8 .....	-	X	X	-	-
OD-14L60	Lockwasher No. 10 .....	-	X	X	-	-
OD-24N4600	Hand hole cover band nut .....	-	X	X	-	-
OD-24N7600	Cutout stud nut .....	-	X	X	-	-
OD-14156004	Regulator terminal screw .....	-	X	X	-	-
OD-14156006	Commutator end bearing cap screw .....	-	X	X	-	-
OD-14160016	Hand hole cover band screw .....	-	X	X	-	-
OD-14205412	Pole piece screw .....	-	X	X	-	-
OD-17156004	Control holding spring screw .....	-	X	X	-	-
ID-17158006	Drive end bearing cap screw .....	-	X	X	-	-
OD-20160004	Brush lead screw .....	-	X	X	-	-
OD-24160004	Battery charge regulator mounting screw .....	-	X	X	-	-
OD-20117	Regulator terminal screw lockwasher .....	-	X	X	-	-
OD-20134	Fuse holder .....	-	X	X	-	-
OD-20660	Control holding spring lockwasher .....	-	X	X	-	-
OD-21262	Battery charge regulator and cutout assembly .....	-	X	X	-	-
OD-22116	Commutator end bearing cap gasket .....	-	X	X	-	-
OD-22139	Oiler .....	-	X	X	-	-
OD-22157	CE felt washer .....	-	X	X	-	-
OD-22158	CE felt washer retainer .....	-	X	X	-	-
OD-22169	Lockwasher No. 10 special .....	-	X	X	-	-
OD-22599	CE bearing retaining ring .....	-	X	X	-	-
OD-22600	Commutator end bearing .....	-	X	X	-	-
OD-22605	Commutator end felt washer cup .....	-	X	X	-	-
OD-22676	Fuse spring .....	-	X	X	-	-
OD-22678	Fuse .....	-	X	X	-	-
OD-22679	Fuse insulation .....	-	X	X	-	-
OD-22748	Adjusting pinion spring washer .....	-	X	X	-	-
OD-22750	Adjusting pinion washer .....	-	X	X	-	-
OD-23150	Battery charge regulator and cutout insulation .....	-	X	X	-	-
OD-23329	Woodruff key No. 7 .....	-	X	X	-	-
OD-23400	Pole piece .....	-	X	X	-	-
OD-23417	Adjusting pinion .....	-	X	X	-	-
OD-23431	Drive end bearing .....	-	X	X	-	-
OD-23432	Hand hole cover band .....	-	X	X	-	-
OD-23450	Insulating tube .....	-	X	X	-	-
OD-23452	Control brush (for Generator Type CO-1119 and CO-1166) .....	-	X	X	-	-
OD-23703	Control brush (for Generator Type CO-1241) .....	-	-	X	-	-
OD-23702	Main brush (for Generator Type CO-1241) .....	-	-	X	-	-
OD-23534	Main brush (for Generator Type CO-1119 and CO-1166) ..	-	X	X	-	-
OD-23538	Commutator end cap .....	-	X	X	-	-
OD-23544	Armature nut .....	-	X	X	-	-
OD-23551	Control brush holding spring .....	-	X	X	-	-
OD-23555	Drive end housing .....	-	X	X	-	-
OD-23557	Field frame .....	-	X	X	-	-
OD-23919	Field frame .....	-	-	X	-	-
OD-23558	Drive end bearing retainer .....	-	X	X	-	-
OD-23559	Drive end felt retainer .....	-	X	X	-	-

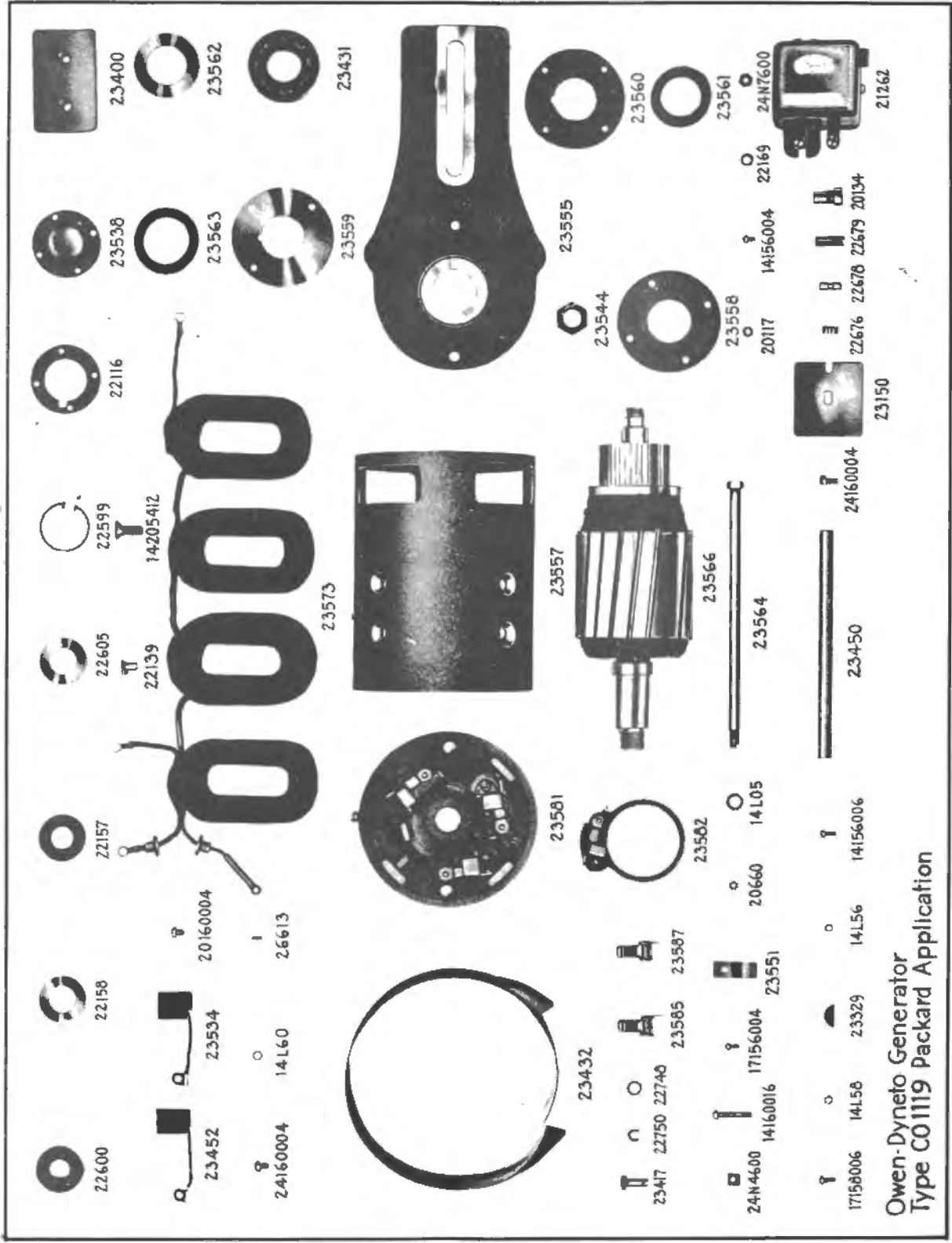

Owen-Dyneto Generator  
Type CO1119 Packard Application

OWEN DYNETO GENERATOR  
TYPE C01166 PACKARD APPLICATION

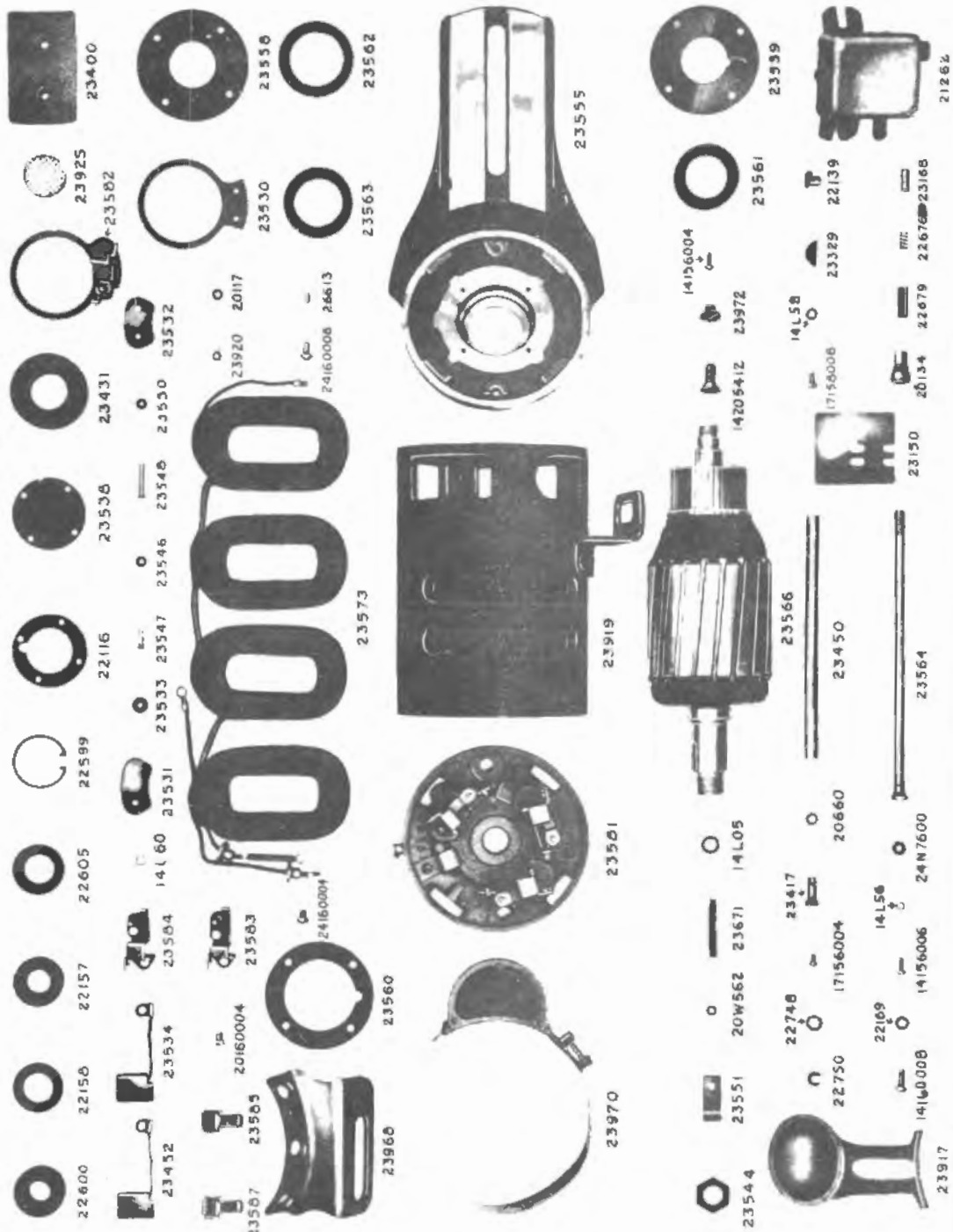

1107-8

Piece No.	Name	No. Required				
		905 906	1005 1006	1107 1108	1207 1208	1407 1408
OD-23560	Drive end gasket .....	-	X	X	-	-
OD-23561	Drive end felt washer .....	-	X	X	-	-
OD-23562	Drive end felt retainer .....	-	X	X	-	-
OD-23563	Drive end felt washer .....	-	X	X	-	-
OD-23564	Through bolt .....	-	X	X	-	-
OD- <del>23560</del>	Armature (for Generator Type CO-1119 and CO-1166) - 4.7.19	-	X	X	-	-
OD-23704	Armature (for Generator Type CO-1241) .....	-	-	X	-	-
OD-23573	Field coil assembly .....	-	X	X	-	-
OD-23581	Commutator end housing assembly (for Generator Type CO-1119 and CO-1166) .....	-	X	X	-	-
OD-23706	Commutator end housing assembly (for Generator Type CO-1241) .....	-	-	X	-	-
OD-23582	Control brush holder assembly .....	-	X	X	-	-
OD-23585	Brush holder spring arm assembly-main .....	-	X	X	-	-
OD-23587	Brush holder spring arm assembly-control .....	-	X	X	-	-
OD-23671	Oil wick-commutator end (Not illustrated) .....	-	X	X	-	-
OD-26693	Dowel pin-commutator end (Not illustrated) .....	-	X	X	-	-
OD-23920	Hand hole band locating pin .....	-	-	X	-	-
OD-23970	Hand hole band assembly .....	-	-	X	-	-
OD-23917	Cooling pipe .....	-	-	X	-	-
OD-23925	Cooling pipe screen .....	-	-	X	-	-
OD-14160008	Screw .....	-	-	X	-	-
OD-23968	Bracket .....	-	-	X	-	-
OD-23972	Bracket screw .....	-	-	X	-	-

## MOTOR GENERATOR

(Owen-Dyneto Type CO-1271)

The following parts are listed with the manufacturers' piece numbers and are to be ordered by these numbers. Dealers should order these parts through their distributor.

OD-14L05	Through bolt lock washer .....	-	-	-	X	-
OD-14L56	Lockwasher No. 6 .....	-	-	-	X	-
OD-14L58	Lockwasher No. 8 .....	-	-	-	X	-
OD-14L60	Lockwasher No. 10 .....	-	-	-	X	-
OD-20W562	Brush holder rivet washer .....	-	-	-	X	-
OD-24N7600	Cutout stud nut .....	-	-	-	X	-
OD-14156004	Regulator terminal screw .....	-	-	-	X	-
OD-14156006	C. E. bearing cap screw .....	-	-	-	X	-
OD-14160008	Cooling pipe mounting screw .....	-	-	-	X	-
OD-14205412	Pole piece screw .....	-	-	-	X	-
OD-17156004	Control brush holder spring screw .....	-	-	-	X	-
OD-17158006	D. E. bearing cap screw .....	-	-	-	X	-
OD-20160004	Brush lead screw .....	-	-	-	X	-
OD-24160004	Cutout regulator mounting screw .....	-	-	-	X	-
OD-24160006	Cutout terminal screw .....	-	-	-	X	-
OD-20117	Regulator terminal screw lock washer .....	-	-	-	X	-
OD-20134	Fuse holder .....	-	-	-	X	-
OD-20660	Control brush holder lockwasher .....	-	-	-	X	-
OD-21248	Cutout cover .....	-	-	-	X	-
OD-22116	C. E. bearing cap gasket .....	-	-	-	X	-
OD-22139	Oiler .....	-	-	-	X	-
OD-22157	C. E. felt washer .....	-	-	-	X	-
OD-22158	C. E. felt washer retainer .....	-	-	-	X	-
OD-22169	Lockwasher No. 10 heavy .....	-	-	-	X	-
OD-22599	C. E. bearing retaining ring .....	-	-	-	X	-

Piece No.	Name	No. Required				
		905 906	1005 1006	1107 1108	1207 1208	1407 1408
OD-22600	C. E. bearing .....	-	-	-	X	-
OD-22605	C. E. felt washer cup .....	-	-	-	X	-
OD-22676	Fuse spring .....	-	-	-	X	-
OD-22679	Fuse insulation .....	-	-	-	X	-
OD-22748	Adjusting pinion spring washer .....	-	-	-	X	-
OD-22750	Adjusting pinion washer .....	-	-	-	X	-
OD-23150	Cutout-regulator insulation .....	-	-	-	X	-
OD-23168	Fuse .....	-	-	-	X	-
OD-23329	Woodruff Key No. 7 .....	-	-	-	X	-
OD-23400	Pole piece .....	-	-	-	X	-
OD-23417	Adjusting pinion .....	-	-	-	X	-
OD-23431	D. E. bearing .....	-	-	-	X	-
OD-23450	Through bolt insulating tube .....	-	-	-	X	-
OD-23530	Control brush holder support .....	-	-	-	X	-
OD-23532	Control brush holder insulation .....	-	-	-	X	-
OD-23533	Control brush holder spacer .....	-	-	-	X	-
OD-23538	C. E. bearing cap .....	-	-	-	X	-
OD-23544	Armature nut .....	-	-	-	X	-
OD-23546	Brush holder insulating bushing .....	-	-	-	X	-
OD-23547	Control brush holder rivet .....	-	-	-	X	-
OD-23548	Main brush holder rivet .....	-	-	-	X	-
OD-23550	Main brush holder bushing (Gr.) .....	-	-	-	X	-
OD-23551	Control brush holder spring .....	-	-	-	X	-
OD-23558	D. E. bearing retainer .....	-	-	-	X	-
OD-23559	D. E. felt retainer .....	-	-	-	X	-
OD-23560	D. E. gasket .....	-	-	-	X	-
OD-23561	D. E. felt washer .....	-	-	-	X	-
OD-23562	D. E. felt retainer .....	-	-	-	X	-
OD-23563	D. E. felt washer .....	-	-	-	X	-
OD-23564	Through bolt .....	-	-	-	X	-
OD-23573	Field coil assembly .....	-	-	-	X	-
OD-23582	Control brush holder assembly .....	-	-	-	X	-
OD-23583	Control brush holder assembly .....	-	-	-	X	-
OD-23585	Brush holder spring arm assembly-main .....	-	-	-	X	-
OD-23587	Brush holder spring arm assembly control .....	-	-	-	X	-
OD-23671	Oil wick - commutator end .....	-	-	-	X	-
OD-23699	Main brush holder insulation live .....	-	-	-	X	-
OD-23700	Main brush holder plate (Gr.) .....	-	-	-	X	-
OD-23702	Main brush - 2 used .....	-	-	-	X	-
OD-23703	Control brush - 1 used .....	-	-	-	X	-
OD-23706	C. E. housing assembly .....	-	-	-	X	-
OD-23708	Main brush holder assembly .....	-	-	-	X	-
OD-23709	Armature .....	-	-	-	X	-
OD-23717	D. E. housing .....	-	-	-	X	-
OD-23750	Mounting bracket .....	-	-	-	X	-
OD-23763	Mounting bracket screw .....	-	-	-	X	-
OD-23815	Field frame .....	-	-	-	X	-
OD-23917	Cooling pipe .....	-	-	-	X	-
OD-23920	Hand hole band locating pin .....	-	-	-	X	-
OD-23925	Cooling pipe screen .....	-	-	-	X	-
OD-23970	Hand hole band assembly .....	-	-	-	X	-
OD-26613	Dowel pin - cooling pipe .....	-	-	-	X	-
OD-40203	Cutout - regulator assembly .....	-	-	-	X	-

Piece No.	Name	No. Required				
		905 906	1005 1006	1107 1108	1207 1208	1407 1408

## MOTOR GENERATOR

(Owen-Dyneto Type CO-1304)

The following parts are listed with the manufacturers' piece numbers and are to be ordered by these numbers. Dealers should order these parts through their distributor.

### FRAME AND FIELD ASSEMBLY

OD-14L05	Lockwasher 5/16" .....	-	-	-	-	2
OD-23695	Frame Screw .....	-	-	-	-	2
OD-24064	Frame and field assembly .....	-	-	-	-	1
OD-23450	Frame Screw Ins. tube .....	-	-	-	-	2
OD-23874	Pole piece .....	-	-	-	-	4
OD-23876	Field coil assembly - Comp. ....	-	-	-	-	1
OD-20064	Ins. tube .....	-	-	-	-	1
OD-22367	Terminal .....	-	-	-	-	1
OD-22773	Terminal .....	-	-	-	-	1
OD-22897	Ins. bushing .....	-	-	-	-	1
OD-23750	Mounting Bracket .....	-	-	-	-	1
OD-23763	Screw 5/16-18 x 7/16" flat hd. ....	-	-	-	-	4
OD-24000	Nut 3/4-16 hex. ....	-	-	-	-	1
OD-24001	Lockwasher 3/4" .....	-	-	-	-	1
OD-23210	Lead Ins. ....	-	-	-	-	3
OD-23594	C. B. lead assembly .....	-	-	-	-	1
OD-22268	Wire Clip .....	-	-	-	-	2
OD-22367	Terminal .....	-	-	-	-	2
OD-22897	Ins. bushing .....	-	-	-	-	1
OD-23877	Field coil - U. R. ....	-	-	-	-	1
OD-23878	Field coil - L. R. ....	-	-	-	-	1
OD-23879	Field coil - L. L. ....	-	-	-	-	1
OD-23880	Field coil - U. L. ....	-	-	-	-	1
OD-23920	Head bend aligning pin .....	-	-	-	-	1
OD-14205412	Pole piece screw .....	-	-	-	-	8

### COMMUTATOR END PLATES ASSEMBLY

OD-14L56	Lockwasher No. 6 .....	-	-	-	-	4
OD-14L60	Lockwasher No. 10 .....	-	-	-	-	3
OD-22116	Gasket .....	-	-	-	-	1
OD-22600	Ball bearing - S.A.E. No. 202 .....	-	-	-	-	1
OD-23669	C. E. cap cover .....	-	-	-	-	1
OD-23703	Brush - 3rd .....	-	-	-	-	1
OD-23846	Brush - Main .....	-	-	-	-	2
OD-23881	Comm. end plate assembly .....	-	-	-	-	1
OD-20660	Washer No. 6 Skpf. ....	-	-	-	-	3
OD-22139	1/4 Oiler - Hinged top .....	-	-	-	-	1
OD-22157	Felt washer .....	-	-	-	-	1
OD-22158	Felt washer retainer .....	-	-	-	-	1
OD-22599	Lock spring ring .....	-	-	-	-	1
OD-22605	Felt guard .....	-	-	-	-	1
OD-22748	Spring washer .....	-	-	-	-	1
OD-22750	Snap ring .....	-	-	-	-	1
OD-23417	3rd brush plate adjusting pinion .....	-	-	-	-	1
OD-23551	3rd brush plate retaining spring .....	-	-	-	-	3
OD-23671	Felt wick .....	-	-	-	-	1
OD-23852	Brush spring .....	-	-	-	-	2



Piece No.	Name	No. Required				
		905 906	1005 1006	1107 1108	1207 1208	1407 1408
OD-24011	3rd brush holder plate assembly .....	-	-	-	-	1
OD-23585	Brush spring .....	-	-	-	-	1
OD-24063	Comm. end plate part assembly .....	-	-	-	-	1
OD-17156004	Screw No. 6-32 x 1/4" round hd. ....	-	-	-	-	3
OD-14156004	Screw No. 6-32 x 1/4" round hd. ....	-	-	-	-	4
OD-20160004	Screw No. 10-32 x 1/4" round hd. ....	-	-	-	-	3

## ARMATURE ASSEMBLY

OD-23329	No. 7 Woodruff Key .....	-	-	-	-	1
OD-23544	Nut 9/16-18 hex. ....	-	-	-	-	1
OD-23709	Armature assembly .....	-	-	-	-	1
OD-23859	Drive pulley .....	-	-	-	-	1

## DRIVE END HEAD ASSEMBLY

OD-23857	Drive end head assembly .....	-	-	-	-	1
OD-14L58	Lockwasher No. 8 .....	-	-	-	-	4
OD-13040	1/4 Oiler - Press in type .....	-	-	-	-	1
OD-23431	Ball bearing - S.A.E. No. 205 .....	-	-	-	-	1
OD-23558	Bearing retainer ..	-	-	-	-	1
OD-23559	Felt washer retainer .....	-	-	-	-	1
OD-23560	Gasket .....	-	-	-	-	2
OD-23561	Felt washer .....	-	-	-	-	3
OD-23562	Felt washer retainer .....	-	-	-	-	1
OD-23563	Felt washer .....	-	-	-	-	1
OD-23844	Oil wick .....	-	-	-	-	1
OD-23856	Drive end head .....	-	-	-	-	1
OD-17158006	Screw No. 8-32 x 3/8" rnd. hd. ....	-	-	-	-	4

## MISCELLANEOUS PARTS

OD-22169	Lockwasher No. 10 .....	-	-	-	-	2
OD-23861	Head bend assembly .....	-	-	-	-	1
OD-40210	C. B. and Reg. assembly .....	-	-	-	-	1
OD-24N7600	Nut No. 10-32 hex. ....	-	-	-	-	1
OD-20117	Lockwasher No. 6 .....	-	-	-	-	1
OD-20134	Fuse retainer .....	-	-	-	-	1
OD-20688	Washer No 10 Skpf. ....	-	-	-	-	1
OD-21248	Cover .....	-	-	-	-	1
OD-22169	Lockwasher No. 10 .....	-	-	-	-	2
OD-22676	Spring .....	-	-	-	-	1
OD-22678	Fuse - 5 Amp. ....	-	-	-	-	1
OD-22679	Insulation .....	-	-	-	-	1
OD-23150	Base Insulation .....	-	-	-	-	1
OD-14156004	Screw No. 6-32 x 1/4" rnd. hd. ....	-	-	-	-	1
OD-14158004	Screw No. 8-32 x 1/4" rnd. hd. ....	-	-	-	-	2
OD-24160006	Screw No. 10-32 x 3/8" rnd. hd. ....	-	-	-	-	2
OD-24160004	Screw No. 10-32 x 1/4" rnd. hd. ....	-	-	-	-	2

## MOTOR IGNITION

216202	Motor ignition high tension cable terminal insulator ...	-	-	12	-	-
205102	Motor ignition high tension cable tube assembly R.H. ...	1	1	1	-	-
205101	Motor ignition high tension cable tube assembly L.H. ...	1	1	1	-	-
203924	Motor ignition high tension cable to spark plug No. 6 right loom 11" long .....	1	-	-	-	-

Piece No.	Name	No. Required				
		905 906	1005 1006	1107 1108	1207 1208	1407 1408
205139	Motor ignition high tension cable to spark plug No. 6 right loom 5-1/2" long .....	1	1	-	-	-
156625	Motor ignition high tension cable to spark plug terminal-female .....	-	-	24	-	-
156626	Motor ignition high tension cable to spark plug terminal-male .....	-	-	24	-	-
209704	Motor ignition spark plug (AC) .....	12	12	12	12	12
311539	Motor ignition spark plug (champion) .....	-	-	-	-	12
228781	Motor ignition spark plug gasket (Use with champion plug) .....	-	-	-	-	12
197531	Motor ignition spark plug gasket (Use with AC plug) ....	12	12	12	12	12
191526	Motor ignition spark plug nut .....	12	12	12	-	-
221499	Motor ignition spark plug nut .....	-	-	-	12	12
156625	Motor ignition spark plug cable terminal-female - distributor end .....	-	-	-	12	12
221459	Motor ignition spark plug cable terminal - spark plug end .....	-	-	-	12	12
156626	Motor ignition spark plug cable terminal-male - distributor end .....	-	-	-	12	12
221016	Motor ignition spark plug cable tube assembly - left bank .....	-	-	-	1	1
221014	Motor ignition spark plug cable tube assembly - right bank .....	-	-	-	1	1
205106	Motor ignition high tension cable tube carburetor throttle retracting spring bracket .....	1	-	-	-	-

## MOTOR INTAKE AND EXHAUST MANIFOLD

207773	Motor (exhaust) manifold .....	-	1	1	-	-
197822	Motor (exhaust) manifold .....	1	-	-	-	-
219947	Motor (exhaust) manifold .....	-	-	-	1	1
197787	Motor (intake) manifold .....	1	1	1	1	1
197830	Motor (intake) manifold-center .....	2	2	2	2	2
197806	Motor (intake) manifold center to cylinder gasket .....	2	2	2	2	2
197817	Motor (intake) manifold center to intake manifold gasket .....	2	2	2	2	2
197804	Motor (intake) manifold center to intake manifold stud .	4	4	4	4	4
144514	Washer .....	4	4	4	4	4
5506	Lockwasher 3/8" .....	4	4	4	4	4
7006	Nut 3/8-24 .....	4	4	4	4	4
210227	Motor (exhaust) manifold automatic choke heat plate ....	-	1	1	1	1
8218	Screw .....	-	2	2	2	2
210231	Plate gasket .....	-	1	1	1	1
202573	Motor (intake) manifold to brake vacuum valve dash connection tube flange stud .....	-	3	3	-	-
202573	Motor (intake) manifold clutch control suction tube flange stud .....	3	-	-	-	-
197808	Motor (intake) and exhaust manifold to cylinder gasket .	4	-	-	-	-
197803	Motor (intake) and exhaust manifold to cylinder stud ...	20	20	20	20	20
197777	Cup washer .....	8	8	8	8	8
144514	Washer .....	12	12	12	12	12
197798	Nut 3/8-24 special .....	20	20	20	20	20
202903	Motor (exhaust) manifold dash heat deflector .....	1	-	-	-	-
5573	Screw 1/4-28 x 1-3/8" hex. hd. ....	2	-	-	-	-
3868	Washer 1/4" .....	2	-	-	-	-
5502	Lockwasher 1/4" .....	2	-	-	-	-
203085	Motor (exhaust) manifold dash heat deflector spacer asb.	2	-	-	-	-
205817	Motor (exhaust) manifold gasket-end .....	4	4	4	4	4
205818	Motor (exhaust) manifold gasket-center .....	4	4	4	4	4
205819	Motor (intake) manifold gasket-end .....	4	4	4	4	4
213505	Motor (intake) manifold drain tube check valve ball ...	-	-	-	1	1
213493	Motor (intake) manifold drain tube check valve ball retainer .....	-	-	-	1	1

Piece No.	Name	No. Required				
		905 906	1005 1006	1107 1108	1207 1208	1407 1408
4282	Cotter pin 1/16 x 3/4" .....	-	-	-	1	1
145255	Motor (intake) manifold drain tube clip .....	-	-	-	1	1
219065	Motor (exhaust) manifold gasoline drain check valve assembly (after Motor No. 901320) (Supersedes 213774 and 213780) .....	-	2	2	-	-
219960	Motor (intake) manifold gasoline drain check valve body gasket .....	-	-	-	2	2
225355	Motor (intake) manifold gasoline drain tube lower asb. .	-	-	-	1	1
225353	Motor (intake) manifold gasoline drain tube upper asb. .	-	-	-	1	1
5867	Union nut 5/16 flared tube .....	-	-	-	1	1
219952	Motor intake manifold gasoline drain tube upper tee ....	-	-	-	1	1
219961	Motor intake manifold gasoline drain tube upper tee gasket .....	-	-	-	2	2
219970	Motor intake manifold gasoline drain tube connector ....	-	-	-	1	1
203791	Motor manifold spacer .....	2	2	2	2	2
203792	Motor manifold spacer gasket .....	4	4	4	4	4
197802	Motor (intake manifold to exhaust manifold) stud .....	2	2	2	2	2
7006	Nut 3/8-24 .....	2	2	2	2	2
6166	Lockwasher 3/8" special .....	2	2	2	2	2
197764	Motor intake manifold trap ejector (Prior to Motor No. 901320) .....	2	2	-	-	-

## MOTOR OIL COOLER

216496	Motor oil cooler .....	-	-	-	1	-
7005	Nut 5/16-24 .....	-	-	-	3	-
5504	Lockwasher 5/16" .....	-	-	-	3	-
221064	Motor oil cooler and filter assembly .....	-	-	-	1	-
219939	Motor oil cooler and filter housing .....	-	-	-	1	-
221043	Drain plug .....	-	-	-	1	-
20075	Gasket .....	-	-	-	1	-
221010	Flushing plug .....	-	-	-	1	-
21662	Gasket .....	-	-	-	1	-
219938	Motor oil cooler and filter housing cover assembly .....	-	-	-	1	-
219955	Motor oil cooler and filter housing cover plug .....	-	-	-	3	-
219956	Motor oil cooler and filter housing cover stud long ....	-	-	-	1	-
221376	Motor oil cooler and filter housing cover stud short ...	-	-	-	7	-
5787	Screw 1/4-28 x 7/8" hex. hd. ....	-	-	-	1	-
5502	Lockwasher 1/4" .....	-	-	-	9	-
3868	Washer 1/4" .....	-	-	-	2	-
7004	Nut 1/4-28 .....	-	-	-	8	-
219894	Motor oil cooler and filter housing cover to cylinder gasket .....	-	-	-	1	-
221174	Screw 3/8-24 x 1-11/16" hex. hd. ....	-	-	-	1	-
6132	Screw 3/8-24 x 1" hex. hd. ....	-	-	-	1	-
221415	Washer 3/8" special .....	-	-	-	1	-
6048	Lockwasher (Shakeproof) .....	-	-	-	2	-
221414	Motor oil cooler and filter housing cover to cylinder screw 3/8-24 x 3-1/8" hex. hd. ....	-	-	-	1	-
219906	Motor oil cooler and filter housing cover gasket .....	-	-	-	1	-
221413	Motor oil cooler and filter housing mounting stud 3/8" special .....	-	-	-	2	-
7006	Nut 3/8" .....	-	-	-	2	-
3877	washer 3/8" .....	-	-	-	2	-
5506	Lockwasher 3/8" .....	-	-	-	2	-
219712	Motor oil cooler and filter housing outlet gasket .....	-	-	-	1	-
223331	Motor oil cooler and filter housing plug .....	-	-	-	1	-
5837	Motor oil cooler and filter housing plug 3/8" headless .	-	-	-	1	-

Piece No.	Name	No. Required				
		905 906	1005 1006	1107 1108	1207 1208	1407 1408
53676	Motor oil cooler and filter housing plug gasket .....	-	-	-	1	-
237172	Motor oil cooler flange gasket (Supersedes 230066) .....	-	-	-	1	-

## MOTOR OIL COOLER

234917	Motor oil cooler (Supersedes 216496) .....	-	-	-	-	1
7005	Nut 5/16-24 .....	-	-	-	-	3
5504	Lockwasher 5/16" .....	-	-	-	-	3
237172	Motor oil cooler flange gasket (Supersedes 230066) .....	-	-	-	-	1
234928	Motor oil cooler housing assembly (Supersedes 230229) ..	-	-	-	-	1
5837	Plug .....	-	-	-	-	1
230222	Motor oil cooler housing cover assembly .....	-	-	-	-	1
219894	Motor oil cooler housing cover to cylinder gasket (Prior to motor No. 909635) .....	-	-	-	-	1
232625	Motor oil cooler housing cover to cylinder gasket (After motor No. 909634) .....	-	-	-	-	1
230234	Motor oil cooler housing cover to cylinder screw .....	-	-	-	-	1
6606	Screw 3/8-24 x 1-3/4" hex. hd. ....	-	-	-	-	1
6605	Screw 3/8-24 x 1" hex. hd. ....	-	-	-	-	1
221415	Washer 3/8" plain special .....	-	-	-	-	1
6048	Lockwasher 3/8" Shakeproof special .....	-	-	-	-	2
230241	Motor oil cooler housing cover plug .....	-	-	-	-	2
230237	Motor oil cooler housing cover stud long - 5/16" special	-	-	-	-	2
230292	Motor oil cooler housing stud short 5/16" .....	-	-	-	-	5
7005	Nut 5/16-24 .....	-	-	-	-	7
5504	Lockwasher 5/16" .....	-	-	-	-	7
5483	Motor oil cooler housing to cover screw 5/16-24 x 3/4" hex. hd. ....	-	-	-	-	1
6020	Screw 5/16-24 x 15/16" hex. hd. ....	-	-	-	-	2
7005	Nut 5/16-24 .....	-	-	-	-	2
5504	Lockwasher 5/16" .....	-	-	-	-	3
230235	Motor oil cooler housing cover gasket .....	-	-	-	-	1
221413	Motor oil cooler housing mounting stud - 3/8" special ..	-	-	-	-	2
7006	Nut 3/8" .....	-	-	-	-	2
3877	Washer 3/8" .....	-	-	-	-	2
5506	Lockwasher 3/8" .....	-	-	-	-	2
219712	Motor oil cooler housing outlet gasket .....	-	-	-	-	1
6646	Motor oil cooler housing plug 3/8 hex. hd. ....	-	-	-	-	1

## MOTOR OIL FILTER

203557	Motor oil filter assembly .....	1	1	1	-	-
6014	Stud 1/4" .....	4	4	4	-	-
5502	Lockwasher .....	4	4	4	-	-
7004	Nut 1/4-28 .....	4	4	4	-	-
180909	Motor oil filter inlet connection .....	1	1	1	-	-
194782	Motor oil filter inlet connection restriction .....	1	1	1	-	-
194783	Motor oil filter inlet connection restriction spring ...	1	1	1	-	-
203562	Motor oil filter inlet tube assembly .....	1	1	1	-	-
157477	Union nut .....	2	2	2	-	-
203560	Motor oil filter inlet tube clip .....	1	1	1	-	-
5898	Screw 1/4-20 x 9/16" round head .....	1	1	1	-	-
5502	Lockwasher 1/4" .....	1	1	1	-	-
180938	Motor oil filter inlet tube connection adapter .....	2	2	2	-	-
203531	Motor oil filter inlet tube to instrument board oil pressure gauge tube lower crankcase tee .....	1	1	1	-	-
203553	Motor oil filter outlet tube assembly .....	1	1	1	-	-
5444	Flared tube union conn. 5/16" .....	1	1	1	-	-
5466	Union nut 5/16" flared tube .....	2	2	2	-	-

Piece No.	Name	No. Required				
		905 906	1005 1006	1107 1108	1207 1208	1407 1408
<b>MOTOR OIL FILTER</b>						
219892	Motor oil filter assembly .....	-	-	-	1	-
221169	Motor oil filter gasket .....	-	-	-	1	-
223348	Motor oil filter locating pin .....	-	-	-	1	-
221584	Motor oil filter operating lever .....	-	-	-	1	-
219903	Motor oil filter operating lever housing cover .....	-	-	-	1	-
219904	Motor oil filter operating lever housing cover gasket ..	-	-	-	1	-
221125	Screw 5/16 x 2-5/8" hex. hd. ....	-	-	-	4	-
5504	Lockwasher 5/16" .....	-	-	-	4	-
221581	Motor oil filter operating lever latch .....	-	-	-	2	-
221582	Motor oil filter operating lever latch pin .....	-	-	-	1	-
221580	Motor oil filter operating lever latch spring .....	-	-	-	1	-
219880	Motor oil filter operating piston .....	-	-	-	1	-
219882	Motor oil filter operating piston plug .....	-	-	-	1	-
230084	Motor oil filter operating piston spring .....	-	-	-	1	-
42123	Gasket .....	-	-	-	1	-
221589	Motor oil filter operating shaft ratchet .....	-	-	-	1	-
223347	Motor oil filter operating shaft ratchet retaining nut .	-	-	-	1	-
7710	Motor oil filter retaining screw No. 10-32 x 5/8" .....	-	-	-	2	-
3866	Washer—plain .....	-	-	-	2	-
5500	Lockwasher 3/16" .....	-	-	-	2	-

**MOTOR OIL FILTER**

223079	Motor oil filter assembly .....	-	-	-	-	1
230238	Motor oil filter bracket .....	-	-	-	-	2
230304	Motor oil filter bracket screw 5/16" special .....	-	-	-	-	4
7005	Nut 5/16-24 .....	-	-	-	-	4
209713	Washer .....	-	-	-	-	4
5504	Lockwasher 5/16" .....	-	-	-	-	4
230224	Motor oil filter flange .....	-	-	-	-	2
237496	Motor oil filter flange gasket (Supersedes 219919) .....	-	-	-	-	2
6243	Screw 5/16-24 x 1-1/8" hex. hd. ....	-	-	-	-	4
5504	Lockwasher 5/16" .....	-	-	-	-	4
230233	Motor oil filter inlet tube assembly .....	-	-	-	-	1
237372	Motor oil filter inlet tube flange gasket (Supersedes 230230) .....	-	-	-	-	1
6605	Screw 3/8-24 x 1" hex. hd. ....	-	-	-	-	1
6048	Lockwasher (Shakeproof) .....	-	-	-	-	1
230232	Motor oil filter outlet tube assembly .....	-	-	-	-	1
237373	Motor oil filter outlet tube flange gasket (Supersedes 230231) .....	-	-	-	-	1
230239	Motor oil filter strap—long .....	-	-	-	-	2
230249	Motor oil filter strap—short .....	-	-	-	-	2
6696	Screw 1/4-28 x 1" fill. hd. ....	-	-	-	-	2
5447	Washer 1/4" Shakeproof .....	-	-	-	-	2
7004	Nut 1/4-28 plain hex. ....	-	-	-	-	2

**MOTOR OIL LEVEL INDICATOR**

197755	Motor oil level indicator assembly (Prior to motor No. 903452) .....	1	1	1	1	-
228896	Motor oil level indicator assembly (After motor No. 903451) .....	-	-	-	1	1
228899	Motor oil level indicator adapter (After motor No. 903451) .....	-	-	-	1	1
197762	Motor oil level indicator gland .....	1	1	1	1	1
197759	Motor oil level indicator gland packing .....	1	1	1	1	1

Piece No	Name	No. Required				
		905 906	1005 1006	1107 1108	1207 1208	1407 1408
<b>MOTOR OIL MANIFOLD</b>						
197767	Motor oil manifold assembly .....	1	1	-	-	-
216190	Motor oil manifold assembly .....	-	-	1	-	-
219815	Motor oil manifold assembly .....	-	-	-	1	1
7804	Retaining screw 5/16-18 x 3/4" .....	8	8	8	6	6
5504	Lockwasher 5/16" .....	10	10	10	6	6
197736	Motor oil manifold bearing flange gasket .....	3	3	3	3	3
197736	Motor oil manifold oil relief flange gasket .....	1	1	1	-	-
219891	Motor oil manifold oil relief flange gasket .....	-	-	-	1	1
197736	Motor oil manifold oil pump flange gasket .....	1	1	1	-	-
216448	Motor oil manifold oil pump flange gasket .....	-	-	-	1	1
203802	Motor oil manifold to oil pump stud .....	2	2	2	2	2
7005	Nut 5/16-24 .....	2	2	2	2	2
5504	Lockwasher 5/16" .....	2	2	2	2	2
6060	Motor oil manifold oil relief flange to cylinder screw 5/16-18 x 7/8" hex. hd. ....	-	-	-	2	2
5504	Lockwasher 5/16" .....	-	-	-	2	2

### MOTOR OIL PAN

203015	Motor oil pan .....	1	1	1	-	-
219909	Motor oil pan .....	-	-	-	1	1
107889	Motor oil pan drain plug .....	1	1	1	-	-
144930	Motor oil pan drain plug .....	-	-	-	1	1
20075	Gasket 1-1/4" annular .....	1	1	1	1	1
197805	Motor oil pan gasket .....	1	1	1	-	-
219920	Motor oil pan gasket .....	-	-	-	1	1
6187	Motor oil pan retaining screw 5/16-18 x 1" hex. hd. ....	30	30	30	28	28
5504	Lockwasher 5/16" .....	30	30	30	28	28
3874	Plain washer .....	30	30	30	28	28

### MOTOR OIL PRESSURE BY PASS VALVE PISTON

219846	Motor oil pressure by pass valve piston .....	-	-	-	1	-
216287	Motor oil pressure by pass valve piston .....	-	-	-	-	1
216340	Motor oil pressure by pass valve spring .....	-	-	-	1	1
221010	Motor oil pressure by pass valve spring retainer .....	-	-	-	1	-
215104	Motor oil pressure by pass valve spring retainer .....	-	-	-	-	1
21662	Gasket .....	-	-	-	1	1

### MOTOR OIL PRESSURE RELIEF VALVE

205783	Motor oil pressure relief valve assembly .....	1	1	1	-	-
203933	Motor oil pressure relief valve adjusting screw .....	1	1	1	-	-
215100	Motor oil pressure relief valve adjusting screw .....	-	-	-	-	1
6188	Lockwasher 1/2" special .....	1	1	1	-	-
6189	Lock nut 1/2-20 special .....	1	1	1	-	-
230246	Motor oil pressure relief valve adjusting screw cap ....	-	-	-	-	1
21662	Cap gasket .....	-	-	-	-	1
215110	Screw nut .....	-	-	-	-	1
21662	Gasket .....	-	-	-	-	1
203932	Motor oil pressure relief valve body .....	1	1	1	-	-
203931	Motor oil pressure relief valve body cap .....	1	1	1	-	-
52676	Motor oil pressure relief valve body cap gasket .....	1	1	1	-	-
215472	Motor oil pressure relief valve body sleeve .....	-	-	-	-	1
6383	Gasket 1-1/8" annular .....	-	-	-	-	1



Piece No	Name	No. Required				
		905 906	1005 1006	1107 1108	1207 1208	1407 1408
197707	Motor oil pressure relief valve piston .....	1	1	1	-	-
219857	Motor oil pressure relief valve piston .....	-	-	-	1	-
215099	Motor oil pressure relief valve piston .....	-	-	-	-	1
219908	Motor oil pressure relief valve spring .....	-	-	-	1	-
216320	Motor oil pressure relief valve spring .....	-	-	-	-	1
219885	Motor oil pressure relief valve spring adjusting screw .	-	-	-	1	-
7006	Motor oil pressure relief valve spring adjusting screw lock nut .....	-	-	-	1	-
219889	Motor oil pressure relief valve spring adjusting screw nut retainer .....	-	-	-	1	-
6383	Motor oil pressure relief valve spring adjusting screw nut .....	-	-	-	1	-
21662	Gasket .....	-	-	-	1	-
207176	Motor oil pressure relief valve spring (Supersedes 197678) .....	1	1	1	-	-
53326	Gasket 1-3/16" annular .....	1	1	1	-	-

## MOTOR OIL PUMP

203086	Motor oil pump assembly .....	1	1	1	-	-
219907	Motor oil pump assembly .....	-	-	-	1	1
197783	Motor oil pump to bearing cap stud .....	1	1	1	1	1
5508	Lockwasher 7/16" .....	1	1	1	1	1
7007	Nut 7/16-20 .....	1	1	1	1	1
197775	Motor oil pump body .....	1	1	1	-	-
216464	Motor oil pump body assembly (Supersedes 216377) .....	-	-	-	1	1
197772	Motor oil pump body cover .....	1	1	1	-	-
216375	Motor oil pump body cover .....	-	-	-	1	1
7827	Screw 1/4-20 x 3/4" hex. hd. mach. ....	5	5	5	5	5
7800	Screw 1/4-20 x 1" hex. hd. mach. ....	1	1	1	-	-
7824	Screw 1/4-28 x 5/8" hex. hd. ....	-	-	-	1	1
5502	Lockwasher 1/4" .....	6	6	6	6	6
201919	Motor oil pump body to crankshaft bearing cap gasket ...	1	1	1	-	-
216449	Motor oil pump body to crankshaft bearing cap gasket ...	-	-	-	1	1
197681	Motor oil pump body dowel .....	1	1	1	1	1
197738	Motor oil pump body gasket .....	1	1	1	-	-
216436	Motor oil pump body gasket .....	-	-	-	1	1
197686	Motor oil pump body stud shaft .....	1	1	1	-	-
197685	Motor oil pump driven impeller .....	1	1	1	-	-
215947	Motor oil pump driven impeller and bushing assembly ....	-	-	-	1	1
216138	Motor oil pump driven impeller shaft .....	-	-	-	1	1
197682	Motor oil pump driving gear .....	1	1	1	1	1
197677	Motor oil pump driving gear lock ring .....	1	1	1	1	1
197680	Motor oil pump driving gear thrust washer .....	1	1	1	1	1
197684	Motor oil pump driving impeller .....	1	1	1	-	-
215489	Motor oil pump driving impeller .....	-	-	-	1	1
216140	Motor oil pump driving impeller shaft .....	-	-	-	1	1
216164	Motor oil pump driving impeller shaft bushing .....	-	-	-	1	1
197809	Motor oil pump shaft .....	1	1	1	-	-
4551	Key No. 5 woodruff .....	1	1	1	1	1
197652	Lock ring .....	1	1	1	-	-
215488	Lock ring .....	-	-	-	1	1

## MOTOR OIL STRAINER

203011	Motor oil strainer bracket cover and tube assembly .....	1	1	1	-	-
216378	Motor oil strainer bracket cover and tube assembly .....	-	-	-	1	1
197784	Retaining stud .....	1	1	1	1	1
7007	Nut 7/16" plain .....	1	1	1	1	1

Piece No.	Name	No. Required				
		905 906	1005 1006	1107 1108	1207 1208	1407 1408
5508	Lockwasher 7/16" .....	1	1	1	1	1
7804	Retaining screw 5/16-18 x 3/4" .....	2	-	-	-	-
5504	Lockwasher 5/16" .....	2	2	2	-	-
203802	Motor oil strainer bracket cover and tube assembly to motor oil pump body cover stud .....	-	-	-	2	2
7005	Nut 5/16-24 .....	-	-	-	2	2
5504	Lockwasher 5/16" .....	-	-	-	2	2
203001	Motor oil strainer cover plate .....	1	1	1	1	1
203002	Motor oil strainer cover plate gasket .....	1	1	1	1	1
6015	Stud 5/16" .....	8	8	8	8	8
5504	Lockwasher 5/16" .....	8	8	8	8	8
7005	Nut 5/16-24 plain .....	8	8	8	8	8
203008	Motor oil strainer frame and screen assembly .....	1	1	1	1	1
197733	Motor oil strainer lock wire .....	1	1	1	1	1
203014	Motor oil strainer support .....	1	1	1	1	1
7828	Clamp bolt 5/16-24 x 1/8" hex. hd. ....	1	1	1	1	1
5504	Lockwasher 5/16" .....	1	1	1	1	1
197736	Motor oil strainer tube flange gasket .....	1	1	1	1	1

MOTOR PISTON

225064	Motor piston assembly - standard .....	12	12	12	12	12
225065	Motor piston assembly - .003 oversize .....	12	12	12	12	12
225066	Motor piston assembly - .005 oversize .....	12	12	12	12	12
225067	Motor piston assembly - .010 oversize .....	12	12	12	12	12
225068	Motor piston assembly - .015 oversize .....	12	12	12	12	12
225069	Motor piston assembly - .020 oversize .....	12	12	12	12	12
225071	Motor piston assembly - .030 oversize .....	12	12	12	12	12
225073	Motor piston assembly - .045 oversize .....	12	12	12	12	12
202838	Motor piston pin (standard) .....	12	12	12	12	12
202814	Motor piston pin - .003 oversize .....	12	12	12	12	12
202815	Motor piston pin - .006 oversize .....	12	12	12	12	12
190021	Motor piston pin lock .....	24	24	24	24	24
228519	Motor piston ring - plain - standard .....	36	36	36	12	12
202800	Motor piston ring - plain - .003 oversize .....	36	36	36	12	12
202801	Motor piston ring - plain - .005 oversize .....	36	36	36	12	12
202802	Motor piston ring - plain - .010 oversize .....	36	36	36	12	12
202803	Motor piston ring - plain - .015 oversize .....	36	36	36	12	12
202804	Motor piston ring - plain - .020 oversize .....	36	36	36	12	12
202805	Motor piston ring - plain - .030 oversize .....	36	36	36	12	12
202806	Motor piston ring - plain - .045 oversize .....	36	36	36	12	12
216235	Motor piston ring - No. 70 - standard .....	-	-	-	24	24
216678	Motor piston ring - No. 70 - .003 oversize .....	-	-	-	24	24
216679	Motor piston ring - No. 70 - .005 oversize .....	-	-	-	24	24
216680	Motor piston ring - No. 70 - .010 oversize .....	-	-	-	24	24
216681	Motor piston ring - No. 70 - .015 oversize .....	-	-	-	24	24
216682	Motor piston ring - No. 70 - .020 oversize .....	-	-	-	24	24
216684	Motor piston ring - No. 70 - .030 oversize .....	-	-	-	24	24
216685	Motor piston ring - No. 70 - .045 oversize .....	-	-	-	24	24
203056	Motor piston ring - slotted No. 85 - standard .....	12	12	12	12	12
202807	Motor piston ring - slotted No. 85 - .003 oversize .....	12	12	12	12	12
202808	Motor piston ring - slotted No. 85 - .005 oversize .....	12	12	12	12	12
202809	Motor piston ring - slotted No. 85 - .010 oversize .....	12	12	12	12	12
202810	Motor piston ring - slotted No. 85 - .015 oversize .....	12	12	12	12	12
202811	Motor piston ring - slotted No. 85 - .020 oversize .....	12	12	12	12	12
202812	Motor piston ring - slotted No. 85 - .030 oversize .....	12	12	12	12	12
202813	Motor piston ring - slotted No. 85 - .045 oversize .....	12	12	12	12	12

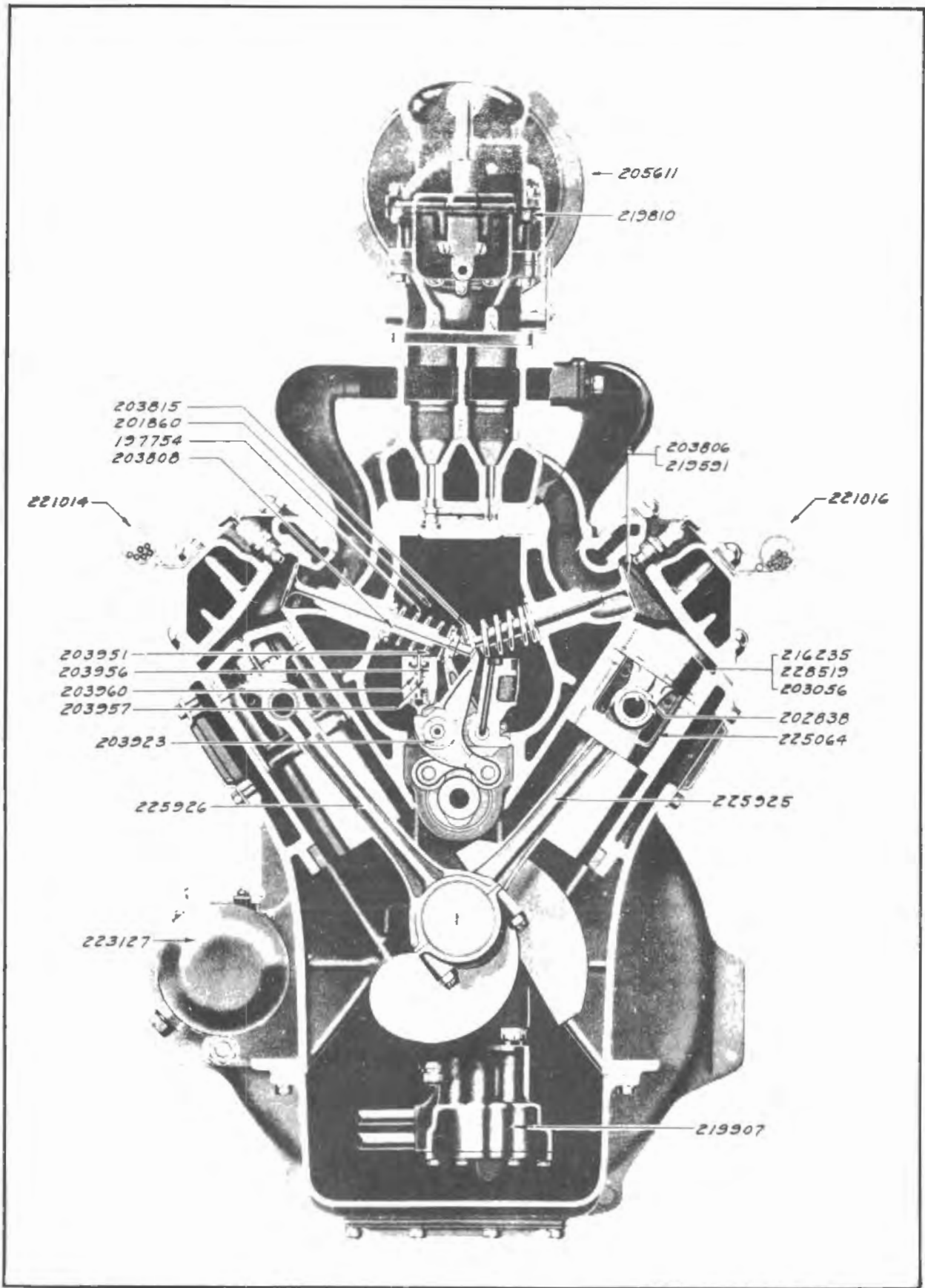

Piece No.	Name	No. Required				
		905 906	1005 1006	1107 1108	1207 1208	1407 1408
<b>MOTOR STABILIZER BRACKET</b>						
207815	Motor stabilizer bracket assembly .....	-	-	-	2	2
6039	Screw 5/16-24 x 11/16" hex. hd. ....	-	-	-	4	4
7005	Nut 5/16-24 .....	-	-	-	4	4
5504	Lockwasher 5/16" .....	-	-	-	4	4
207582	Motor stabilizer bracket bolt plate .....	-	-	-	4	4
7809	Motor stabilizer bracket bolt plate screw 5/16-24 x 7/8" hex. hd. ....	-	-	-	4	4
7005	Nut 5/16-24 .....	-	-	-	4	4
5504	Lockwasher 5/16" .....	-	-	-	4	4
223066	Motor stabilizer bracket plate right .....	-	-	-	1	1
207816	Motor stabilizer bracket plate left .....	-	-	-	1	1
7822	Motor to stabilizer bracket plate bolt (Screw 3/8-24 x 1-1/2" hex. hd.) .....	-	-	-	2	2
5506	Lockwasher 3/8" .....	-	-	-	2	2
7006	Nut 3/8-24 .....	-	-	-	2	2

### MOTOR STARTER MOTOR

201234	Motor starter motor and switch assembly .....	1	1	1	-	-
223127	Motor starter motor and switch assembly .....	-	-	-	1	1
6157	Screw 1/2-20 x 1-1/2" hex. hd. ....	1	1	1	1	1
5510	Lockwasher 1/2" .....	1	1	1	1	1

### MOTOR STARTER MOTOR AND MAGNETIC SWITCH

(Owen-Dyneto Type DN-1072 and DN-1162)

The following parts are listed with the manufacturers' piece numbers and are to be ordered by these numbers. Dealers should order these parts through their distributor.

OD-14L05	Terminal post nut lock washer .....	x	x	x	-	-
OD-12N1600	Brush ring screw nut .....	x	x	x	-	-
OD-12L60010	Brush ring screw .....	x	x	x	-	-
OD-14304308	Commutator end housing screw .....	x	x	x	-	-
OD-14304310	Bendix support attaching screw .....	x	x	x	-	-
OD-14305410	Pole piece screw .....	x	x	x	-	-
OD-17160005	Switch mounting screw .....	x	x	x	-	-
OD-20160006	Brush lead screw .....	x	x	x	-	-
OD-24158005	Commutator end cover screw .....	x	x	x	-	-
OD-13093-2	Bendix drive spring (for Starter Motor Type DN-1072)	x	x	-	-	-
OD-16369-2	Bendix spring (for Starter Motor Type DN-1162) .....	-	x	x	-	-
OD-16369-3	Bendix driving head (for Starter Motor Type DN-1162)	-	x	x	-	-
OD-13093-3	Bendix driving head (for Starter Motor Type DN-1072)	x	x	-	-	-
OD-13093-4	Bendix drive clip (for Starter Motor Type DN-1072) .	x	x	x	-	-
OD-13093-5	Bendix lock screw (for Starter Motor Type DN-1072) .	x	x	-	-	-
OD-16369-5	Shaft spring screw (for Starter Motor Type DN-1162).	-	x	x	-	-
OD-16369-6	Drive head spring screw (for Starter Motor Type DN-1162) .....	-	x	x	-	-
OD-16369-7	Bendix lock washer (for Starter Motor Type DN-1162).	-	x	x	-	-
OD-13093-6	Bendix driving screw (for Starter Motor Type DN-1072) .....	x	x	-	-	-
OD-13119	Name plate (not illustrated) .....	x	x	x	-	-
OD-13170	Armature shaft drive end shim washer (thin) .....	x	x	x	-	-
OD-13306	Brush spring .....	x	x	x	-	-
OD-13348	Bendix drive key .....	x	x	x	-	-

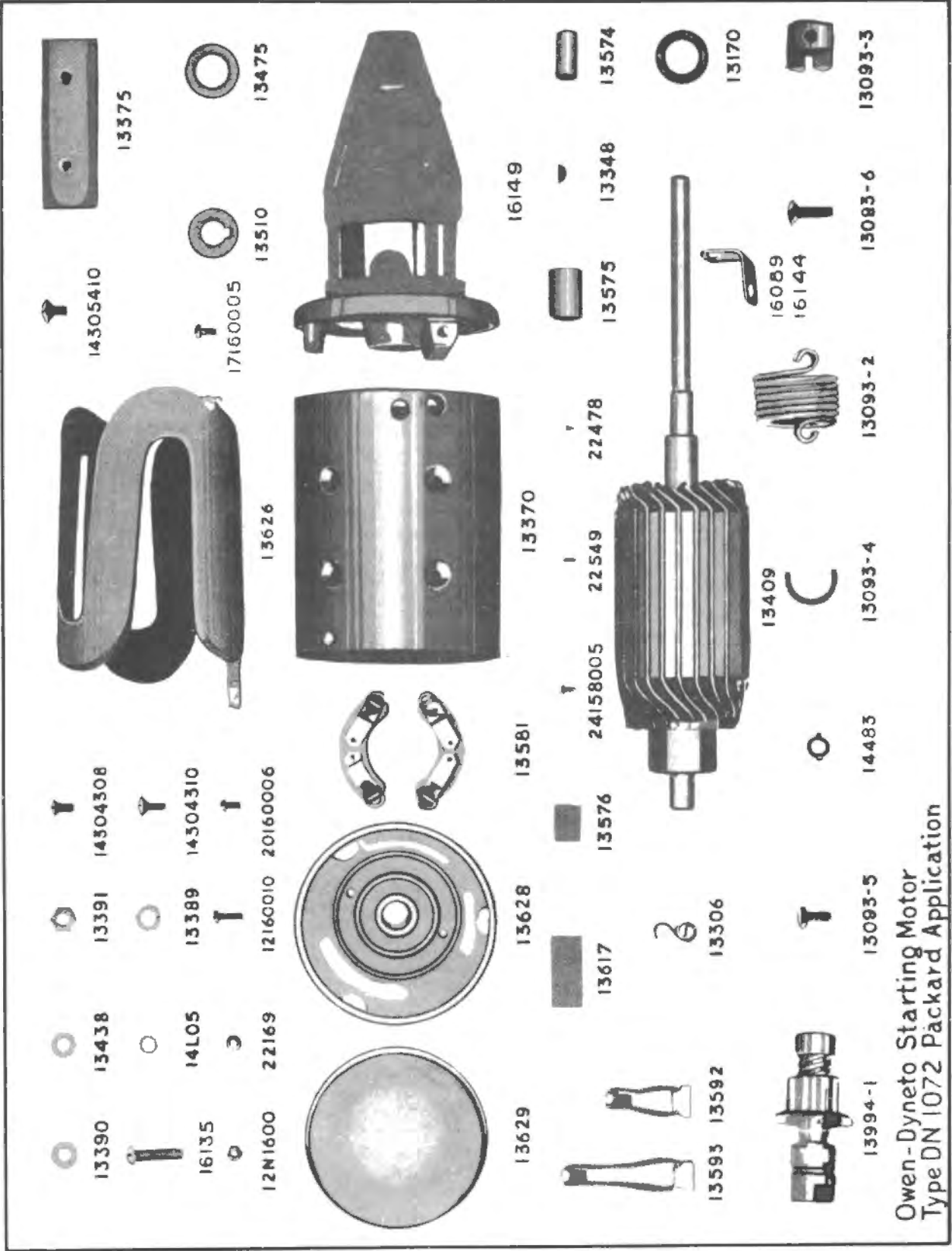

Owen-Dyneto Starting Motor  
Type DN 1072 Packard Application

Piece No.	Name	No. Required				
		905 906	1005 1006	1107 1108	1207 1208	1407 1408
OD-13370	Field frame .....	X	X	X	-	-
OD-13375	Pole piece .....	X	X	X	-	-
OD-13389	Terminal post brass washer (thin) .....	X	X	X	-	-
OD-13390	Terminal post insulating bushing .....	X	X	X	-	-
OD-13391	Terminal post nut .....	X	X	X	-	-
OD-13409	Armature .....	X	X	X	-	-
OD-13438	Terminal post brass washer (thick) .....	X	X	X	-	-
OD-13475	Thrust washer (inner) .....	X	X	X	-	-
OD-13510	Thrust washer (outer) .....	X	X	X	-	-
OD-13574	Bendix support bushing (small) .....	X	X	X	-	-
OD-13575	Bendix support bushing (large) .....	X	X	X	-	-
OD-13576	Commutator end housing bushing .....	X	X	X	-	-
OD-13581	Brush ring assembly .....	X	X	X	-	-
OD-13592	Brush (short lead - 3 used) .....	X	X	X	-	-
OD-13593	Brush (long lead - 1 used) .....	X	X	X	-	-
OD-13617	Brush lead insulation .....	X	X	X	-	-
OD-13626	Field coil .....	X	X	X	-	-
OD-13627	Commutator end housing assembled with brush ring (not illustrated) See parts number 136628, 13581 .	X	X	X	-	-
OD-13628	Commutator end housing with bushing .....	X	X	X	-	-
OD-13629	Commutator end cover .....	X	X	X	-	-
OD-13634	CE housing assembly complete with brush ring and brushes (not illustrated) .....	X	X	X	-	-
OD-13994	Bendix drive complete (not illustrated) (for Starter Motor Type DN-1072) .....	X	X	-	-	-
OD-16369	Bendix drive complete (not illustrated) (for Starter Motor Type DN-1162) .....	-	X	X	-	-
OD-16369-1	Bendix gear and shaft assembly (for Starter Motor Type DN-1162) .....	-	X	X	-	-
OD-13994-1	Bendix gear and shaft assembly (for Starter Motor Type DN-1072) .....	X	X	-	-	-
OD-14483	Bendix drive lock washer .....	X	X	X	-	-
OD-16089	Connector magnetic switch to starter terminal (DN Motor) .....	X	X	X	-	-
OD-16135	Terminal post .....	X	X	X	-	-
OD-16144	Connector magnetic switch to starter terminal (DI Motor) .....	X	X	X	-	-
OD-22169	Brush lead screw and brush ring screw lock washer ..	X	X	X	-	-
OD-22478	Name plate driving screw .....	X	X	X	-	-
OD-22549	Commutator end cover pin .....	X	X	X	-	-

### MOTOR STARTER MOTOR AND MAGNETIC SWITCH

(Owen-Dyneto Type DN-1273)

The following parts are listed with the manufacturers' piece numbers and are to be ordered by these numbers. Dealers should order these parts through their distributor.

OD-10L60	Magnetic switch terminal screw lock washer .....	-	-	-	X	-
OD-14L06	Terminal post lock washer .....	-	-	-	X	-
OD-14L60	Brush lead screw lock washer .....	-	-	-	X	-
OD-12N1600	Brush ring screw nut .....	-	-	-	X	-
OD-12160010	Brush ring screw .....	-	-	-	X	-
OD-14205410	Pole piece screw .....	-	-	-	X	-
OD-14304308	CE housing screw .....	-	-	-	X	-
OD-14304310	Bendix support attaching screw .....	-	-	-	X	-
OD-17160005	Switch mounting screw .....	-	-	-	X	-
OD-17256006	Switch base screw .....	-	-	-	X	-



Piece No.	Name	No. Required				
		905 906	1005 1006	1107 1108	1207 1208	1407 1408
OD-20160004	Screw - brush lead to ground .....	-	-	-	X	-
OD-24158005	CE cover screw .....	-	-	-	X	-
OD-13119	Name plate .....	-	-	-	X	-
OD-13170	Armature shaft DE shim washer (thin) .....	-	-	-	X	-
OD-13348	Bendix drive key .....	-	-	-	X	-
OD-13391	Terminal post nut .....	-	-	-	X	-
OD-13409	Armature .....	-	-	-	X	-
OD-13475	Thrust washer (inner) .....	-	-	-	X	-
OD-13510	Thrust washer (outer) .....	-	-	-	X	-
OD-13574	Bendix support bushing (small) .....	-	-	-	X	-
OD-13575	Bendix support bushing (large) .....	-	-	-	X	-
OD-13576	CE housing bushing .....	-	-	-	X	-
OD-13581	Brush ring assembly .....	-	-	-	X	-
OD-13592	Brush (short lead - 3 used) .....	-	-	-	X	-
OD-13593	Brush (long lead - 1 used) .....	-	-	-	X	-
OD-13617	Brush lead insulation .....	-	-	-	X	-
OD-13622	Pole piece .....	-	-	-	X	-
OD-13626	Field coil .....	-	-	-	X	-
OD-13627	CE housing assembled with brush ring (See parts Nos. 13581 and 13628) .....	-	-	-	X	-
OD-13628	CE housing with bushing .....	-	-	-	X	-
OD-13629	CE cover .....	-	-	-	X	-
OD-13634	CE housing assembly complete with brush ring and brushes .....	-	-	-	X	-
OD-13701	Terminal post insulating washer .....	-	-	-	X	-
OD-13702	Terminal post insulating bushing .....	-	-	-	X	-
OD-13769	Switch terminal washer (Plain) .....	-	-	-	X	-
OD-13979	Brush spring .....	-	-	-	X	-
OD-16135	Terminal post .....	-	-	-	X	-
OD-16144	Connector - magnetic switch to terminal post .....	-	-	-	X	-
OD-16149	Bendix drive support .....	-	-	-	X	-
OD-16152	Field frame .....	-	-	-	X	-
OD-16369-2	Bendix spring .....	-	-	-	X	-
OD-16369-3	Bendix drive head .....	-	-	-	X	-
OD-16369-5	Bendix shaft spring screw .....	-	-	-	X	-
OD-16369-6	Bendix drive head spring screw .....	-	-	-	X	-
OD-16369-7	Bendix lock washer .....	-	-	-	X	-
OD-16398	Screw - brush lead to field terminal .....	-	-	-	X	-
OD-16511	Bendix drive complete .....	-	-	-	X	-
OD-16511-1	Bendix pinion sub-assembly .....	-	-	-	X	-
OD-20887	Switch terminal nut .....	-	-	-	X	-
OD-21069	Switch terminal insulating bushing .....	-	-	-	X	-
OD-21489	Switch terminal (long) .....	-	-	-	X	-
OD-21495	Switch terminal insulator (outer) .....	-	-	-	X	-
OD-21513	Switch magnet assembly .....	-	-	-	X	-
OD-21516	Switch terminal insulator (inner) .....	-	-	-	X	-
OD-21519	Switch terminal (short) .....	-	-	-	X	-
OD-21655	Switch cover .....	-	-	-	X	-
OD-21675	Switch base .....	-	-	-	X	-
OD-21676	Magnetic switch complete .....	-	-	-	X	-
OD-21756	Switch cover screw .....	-	-	-	X	-
OD-22169	Brush lead screw lock washer .....	-	-	-	X	-
OD-22478	Name plate drive screw .....	-	-	-	X	-
OD-22549	CE cover pin .....	-	-	-	X	-

Piece No.	Name	No. Required				
		905 906	1005 1006	1107 1108	1207 1208	1407 1408

**MOTOR STARTER MOTOR AND SWITCH**

(Owen-Dyneto Type DN-1299)

The following parts are listed with the manufacturers' piece numbers and are to be ordered by these numbers. Dealers should order these parts through their distributor.

**FRAME AND FIELD ASSEMBLY WITH TERMINAL POST**

OD-13617	Field connection ins. ....	-	-	-	-	1
OD-16547	Frame and Field Assembly .....	-	-	-	-	1
OD-14105	Lockwasher 5/16" .....	-	-	-	-	1
OD-13389	Terminal washer .....	-	-	-	-	2
OD-13391	Nut 5/16-18 hex. ....	-	-	-	-	1
OD-13622	Pole piece .....	-	-	-	-	6
OD-13626	Field coil assembly-comp. ....	-	-	-	-	1
OD-13701	Ins. washer .....	-	-	-	-	2
OD-13702	Ins. bushing .....	-	-	-	-	1
OD-16135	Terminal post .....	-	-	-	-	1
OD-16541	Connector .....	-	-	-	-	1
OD-14205410	Pole piece screw .....	-	-	-	-	12

**COMMUTATOR END HEAD ASSEMBLY**

OD-14160	Lock washer No. 10 .....	-	-	-	-	2
OD-13592	Brush-short pigtail .....	-	-	-	-	3
OD-13593	Brush-long pigtail .....	-	-	-	-	1
OD-13627	Comm. End head assembly .....	-	-	-	-	1
OD-12N1600	Nut No. 10-32 hex. ....	-	-	-	-	2
OD-13576	Absorbent bronze bearing .....	-	-	-	-	1
OD-13980	Brush holder plate assembly .....	-	-	-	-	1
OD-13979	Brush spring .....	-	-	-	-	4
OD-22169	Lock washer No. 10 .....	-	-	-	-	2
OD-22549	Dowel pin .....	-	-	-	-	1
OD-12160010	Screw No. 10-32 x 5/8" rnd. hd. ....	-	-	-	-	2
OD-13629	Cover .....	-	-	-	-	1
OD-16398	Screw No. 10-32 x 3/8" bdg. hd. ....	-	-	-	-	1
OD-20053	Washer - No. 10 Skpf. ....	-	-	-	-	1
OD-14204308	Screw 1/4-20 x 1/2" flat hd .....	-	-	-	-	3
OD-20160004	Screw No. 10-32 x 1/4" round hd. ....	-	-	-	-	2
OD-24158005	Screw No. 8-32 x 5/16" round hd. ....	-	-	-	-	1

**ARMATURE ASSEMBLY**

OD-13170	Thrust washer .....	-	-	-	-	4
OD-13348	No. 6 Woodruff key .....	-	-	-	-	1
OD-13409	Armature assembly .....	-	-	-	-	1
OD-13475	Thrust washer .....	-	-	-	-	1
OD-13510	Thrust washer .....	-	-	-	-	1

**SWITCH ASSEMBLY**

OD-SS-4001	Solenoid starting switch .....	-	-	-	-	1
OD-12X-196	Lock washer No. 10 .....	-	-	-	-	1
OD-8X-832	Nut 5/16-24 hex. ....	-	-	-	-	2
OD-12X-1014	Lock washer 5/16" .....	-	-	-	-	2

Piece No.	Name	No. Required				
		905 906	1005 1006	1107 1108	1207 1208	1407 1408
OD-8X-1372	Nut No. 10-32 hex. ....	-	-	-	-	1
OD-22189	Lock washer No. 10 .....	-	-	-	-	2
OD-17160005	Screw No. 10-32 x 5/16" round hd. ....	-	-	-	-	2

## MISCELLANEOUS PARTS

OD-16149	Pinion housing assembly .....	-	-	-	-	1
OD-13574	Absorbent bronze bearing .....	-	-	-	-	1
OD-13575	Absorbent bronze bearing .....	-	-	-	-	1
OD-16511	Bendix drive assembly .....	-	-	-	-	1
OD-14204310	Screw 1/4-20 x 5/8" flat hd. ....	-	-	-	-	1

## MOTOR SUPPORT

201138	Motor support front assembly - left .....	1	-	-	-	-
201137	Motor support front assembly - right .....	1	-	-	-	-
209190	Motor support front assembly - left .....	-	1	1	-	-
209246	Motor support front assembly - left (Used only on bodies D758-D759-D858-9-4000-1-2-3) ....	-	1	1	-	-
209191	Motor support front assembly - right .....	-	1	1	-	-
209247	Motor support front assembly - right (Used only on bodies D758-D759-D858-9-4000-1-2-3) ....	-	1	1	-	-
6083	Motor support front-bolt .....	2	2	2	-	-
7008	Nut 1/2-20 .....	2	2	2	-	-
5123	Plain washer 1/2" .....	2	2	2	-	-
5510	Lockwasher 1/2" .....	2	2	2	-	-
207288	Motor support front brace .....	-	1	-	-	-
213938	Motor support front liner .....	-	2	2	-	-
7861	Motor support front mounting plate screw-long 5/16-24 x 1" .....	4	-	-	-	-
7804	Screw-short 5/16-24 x 3/4" .....	4	-	-	-	-
7809	Screw-long 5/16-24 x 7/8" .....	-	4	4	-	-
5449	Screw-short 5/16-24 x 3/4" hex. hd. ....	-	4	4	-	-
5504	Lockwasher 5/16" .....	8	8	8	-	-
7005	Nut 5/16-24 plain .....	8	8	8	-	-
3874	Plain washer 5/16" .....	8	8	8	-	-
201470	Motor support rear assembly .....	2	-	-	-	-
207818	Motor support rear assembly .....	-	2	2	-	-
7818	Motor support rear to frame channel bolt-short 3/8-24 x 7/8" .....	6	6	6	-	-
5891	Motor support rear to frame channel bolt-long 3/8-24 x 1" .....	1	1	1	-	-
201505	Motor support rear to frame channel-bolt-special (clutch pedal retracting spring support) .....	1	1	1	-	-
5506	Lockwasher 3/8" .....	8	8	8	-	-
3877	Plain washer 3/8" .....	8	8	8	-	-
7006	Nut 3/8-24 plain .....	8	8	8	-	-
6068	Motor support rear to motor bolt .....	4	4	4	-	-
7007	Nut 7/16" plain .....	4	4	4	-	-
5508	Lockwasher 7/16" .....	4	4	4	-	-
3883	Plain washer 7/16" .....	4	4	4	-	-

## MOTOR SUPPORT

223271	Motor support channel front assembly .....	-	-	-	1	1
5958	Screw 3/8-24 x 13/16" hex. hd. ....	-	-	-	3	3
5506	Lock washer 3/8" .....	-	-	-	4	4

Piece No.	Name	No. Required				
		905 906	1005 1006	1107 1108	1207 1208	1407 1408
7006	Nut 3/8-24 .....	-	-	-	4	4
223346	Motor support channel front bracket-right .....	-	-	-	1	1
223345	Motor support channel front bracket-left .....	-	-	-	1	1
7818	Motor support channel front bracket to frame screw 3/8-24 x 7/8" hex. hd. ....	-	-	-	6	6
7006	Nut 3/8-24 .....	-	-	-	6	6
5506	Lockwasher 3/8" .....	-	-	-	6	6
223340	Motor support channel-rear .....	-	-	-	1	1
7818	Screw 3/8-24 x 7/8" hex. hd. ....	-	-	-	8	8
7872	Screw 3/8-24 x 3/4" hex. hd. ....	-	-	-	2	2
5506	Lockwasher 3/8" .....	-	-	-	10	10
7006	Nut 3/8-24 .....	-	-	-	10	10
223115	Motor support channel rear brace assembly .....	-	-	-	1	1
7823	Screw 3/8-24 x 15/16" hex. hd. ....	-	-	-	1	1
5506	Lockwasher 3/8" .....	-	-	-	1	1
7006	Nut 3/8-24 .....	-	-	-	1	1
207651	Motor support channel rear bracket .....	-	-	-	2	2
5958	Screw 3/8-24 x 13/16" hex. hd. ....	-	-	-	8	8
5506	Lockwasher 3/8" .....	-	-	-	8	8
7006	Nut 3/8-24 .....	-	-	-	8	8
207542	Motor support rear insulator assembly .....	-	-	-	2	2
5260	Screw 3/8-24 x 2-1/2" hex. hd. ....	-	-	-	3	3
7844	Screw 3/8-24 x 2-7/8" hex. hd. ....	-	-	-	1	1
5506	Lockwasher 3/8" .....	-	-	-	8	8
7006	Nut 3/8-24 .....	-	-	-	8	8
3877	Washer 3/8" .....	-	-	-	1	1
207657	Motor support rear insulator bracket .....	-	-	-	2	2
5506	Lockwasher 3/8" .....	-	-	-	8	8
7006	Nut 3/8-24 .....	-	-	-	8	8
3877	Washer 3/8" .....	-	-	-	1	1
207661	Motor support rear insulator spacer .....	-	-	-	2	2

## MOTOR VACUUM CHECK VALVE MOTOR VALVE

221035	Motor vacuum check valve assembly .....	-	-	-	1	1
202572	Motor vacuum check valve body to manifold gasket .....	-	-	-	1	1
202573	Motor vacuum check valve body to manifold stud .....	-	-	-	3	3
5502	Lockwasher 1/4" std. ....	-	-	-	3	3
7004	Nut 1/4-28 .....	-	-	-	3	3
219997	Motor vacuum check valve and cover assembly .....	-	-	-	1	1
5822	Screw 1/4-28 x 5/8" hex. hd. ....	-	-	-	4	4
5502	Lockwasher .....	-	-	-	4	4
225614	Motor vacuum check valve cover gasket .....	-	-	-	1	1
7004	Motor vacuum check valve retaining nut 1/4-28 .....	-	-	-	3	3
5502	Lockwasher 1/4" .....	-	-	-	3	3
221036	Motor vacuum check valve body and tube assembly .....	-	-	-	1	1
203178	Motor vacuum check valve tube to dash connection union .	-	-	-	1	1
203177	Union nut .....	-	-	-	1	1
225630	Motor vacuum check valve to vacuum pump vacuum tube asb.	-	-	-	1	1
5444	Union connection 5/16" flared tube .....	-	-	-	1	1
5867	Union nut 5/16" flared tube .....	-	-	-	2	2
225606	Motor vacuum pump inlet connection .....	-	-	-	1	1

Piece No	Name	No. Required				
		905 906	1005 1006	1107 1108	1207 1208	1307 1308
<b>MOTOR VALVE</b>						
In replacing valve, valve spring seat or valve key on motor's prior to No. 90086, order all three items, valve, key and valve spring seat.						
203806	Motor valve inlet .....	12	12	12	12	12
219591	Motor valve exhaust .....	12	12	12	12	12
205042	Motor valve chamber breather .....	1	1	1	1	1
205043	Motor valve chamber breather baffle .....	1	1	1	1	1
201946	Motor valve chamber breather stud .....	2	2	2	2	2
3874	Washer .....	2	2	2	2	2
5504	Lockwasher .....	2	2	2	2	2
7005	Nut .....	2	2	2	2	2
197638	Motor valve chamber breather gasket .....	1	1	1	1	1
197831	Motor valve cover assembly .....	1	1	1	-	-
219967	Motor valve cover assembly .....	-	-	-	1	1
5391	Screw 5/16-18 x 1-1/4" hex. hd. ....	-	-	-	1	1
6185	Screw 5/16-18 x 5/8" hex. hd. ....	9	9	9	8	8
6044	Lockwasher 5/16" Shakeproof .....	9	9	9	9	9
202686	Motor valve cover drain tube assembly .....	1	1	1	-	-
203075	Motor valve cover drain tube connection .....	1	1	1	-	-
111192	Motor valve cover drain tube connection gasket .....	2	2	2	-	-
203077	Motor valve cover drain tube connection retainer .....	1	1	1	-	-
203076	Motor valve cover drain tube connection retainer screw .	1	1	1	-	-
120813	Motor valve cover drain tube connection retainer screw lock wire 3" long .....	1	1	1	-	-
197835	Motor valve cover filler front half .....	1	1	1	1	1
197836	Motor valve cover filler rear half .....	1	1	1	1	1
197833	Motor valve cover gasket .....	1	1	1	-	-
219969	Motor valve cover gasket .....	-	-	-	1	1
219968	Motor valve cover gasket retainer .....	-	-	-	1	1
197834	Motor valve cover gasket retainer .....	1	1	1	-	-
201052	Oval head rivet .....	12	12	12	12	12
202289	Motor valve silencer bracket and rocker levers assembly.	3	-	-	-	-
205176	Motor valve silencer bracket and rocker levers assembly.	-	3	3	3	3
203018	Motor valve silencer bracket .....	3	-	-	-	-
203960	Motor valve silencer bracket .....	-	3	3	3	3
203061	Stud .....	8	-	-	-	-
6190	Stud 1/2-20 x 4-3/4" .....	-	8	8	8	8
5510	Lockwasher 1/2" .....	8	8	8	8	8
7008	Nut 1/2" plain .....	8	8	8	8	8
197778	Cup washer .....	4	-	-	-	-
203019	Motor valve silencer bracket retaining clamp .....	2	-	-	-	-
203954	Motor valve silencer bracket retaining clamp-end .....	-	2	2	2	2
203950	Motor valve silencer bracket retaining clamp-center ....	-	2	2	2	2
203906	Motor valve silencer cylinder plug .....	24	-	-	-	-
197714	Motor valve silencer cylinder plug gasket .....	24	-	-	-	-
203884	Motor valve silencer dash pot .....	24	-	-	-	-
203952	Motor valve silencer dash pot .....	-	24	24	24	24
203893	Motor valve silencer dash pot piston .....	24	-	-	-	-
197715	Motor valve silencer piston .....	24	-	-	-	-
203955	Motor valve silencer piston .....	-	24	24	24	24
197781	Motor valve silencer piston spring .....	24	-	-	-	-
203953	Motor valve silencer piston spring .....	-	24	24	24	24
201974	Motor valve silencer reservoir cover .....	24	-	-	-	-
203883	Motor valve silencer valve assembly .....	24	-	-	-	-
203956	Motor valve silencer valve .....	-	24	24	24	24
203951	Motor valve silencer valve guide .....	-	24	24	24	24
203957	Motor valve silencer valve seat .....	-	24	24	24	24

Part No.	Name	No. Required				
		905 906	1005 1006	1107 1108	1207 1208	1407 1408
203961	Motor valve silencer valve spring .....	-	24	24	24	24
203940	Motor valve silencer valve spring retainer .....	-	24	24	24	24
203946	Motor valve silencer valve spring retainer lock ring ...	-	24	24	24	24
201860	Motor valve spring .....	24	24	24	24	24
203808	Motor valve spring seat upper .....	24	24	24	24	24
203815	Motor valve spring seat lower .....	24	24	24	24	24
203911	Motor valve spring seat key .....	24	24	24	24	24
197754	Motor valve stem guide .....	24	24	24	24	24
197639	Motor valve stem guide lock ring .....	24	24	24	24	24

## MOTOR VIBRATION DAMPER

201075	Motor vibration damper assembly .....	1	1	1	-	-
219921	Motor vibration damper assembly .....	-	-	-	1	1
183761	Dowel pin .....	6	6	6	6	6
195916	Motor vibration damper flywheel assembly-front half ....	1	1	1	1	1
203309	Motor vibration damper flywheel assembly-rear half ....	1	1	1	-	-
219957	Motor vibration damper flywheel assembly-rear half ....	-	-	-	1	1
195903	Motor vibration damper flywheel bushing .....	2	2	2	2	2
183770	Motor vibration damper flywheel clamp screw .....	6	6	6	6	6
5504	Lockwasher 5/16" .....	6	6	6	6	6
190472	Motor vibration damper flywheel spring .....	12	12	12	12	12
183763	Motor vibration damper friction disc .....	2	2	2	2	2
183764	Motor vibration damper friction plate .....	2	2	2	2	2
185416	Motor vibration damper friction plate spacer .....	1	1	1	1	1
197766	Motor vibration damper hub assembly .....	1	1	1	1	1

## MOTOR WATER PUMP

209065	Motor water pump assembly .....	-	1	1	-	-
203294	Motor water pump assembly .....	1	-	-	-	-
219358	Motor water pump assembly .....	-	-	-	1	1
219820	Motor water pump body .....	-	-	-	1	1
202954	Motor water pump body .....	1	-	-	-	-
209066	Motor water pump body .....	-	1	1	-	-
197807	Motor water pump body gasket .....	1	1	1	-	-
219959	Motor water pump body gasket .....	-	-	-	1	1
221005	Motor water pump body to gear cover inlet hose .....	-	-	-	1	1
201218	Hose clamp .....	-	-	-	2	2
197820	Motor water pump retaining stud-short .....	3	3	2	2	2
201894	Motor water pump retaining stud-long .....	3	3	4	4	4
7006	Nut 3/8-24 plain .....	6	6	5	6	6
5506	Lockwasher 3/8" .....	6	6	5	6	6
203280	Motor water pump felt .....	4	4	4	5	5
219254	Motor water pump felt .....	-	-	1	-	-
203269	Motor water pump felt retainer .....	2	2	2	2	2
117970	Motor water pump impeller screw .....	1	1	1	1	1
184722	Motor water pump oil cup .....	1	1	1	1	1
197720	Motor water pump outlet sleeve .....	2	2	2	2	2
197706	Motor water pump outlet sleeve gasket .....	2	2	2	2	2
202953	Motor water pump shaft bearing .....	2	2	2	2	2
203275	Motor water pump shaft bearing retainer .....	1	1	1	1	1
5687	Screw 1/4-28 x 5/8" fill. hd. ....	4	4	4	4	4
5502	Lockwasher 1/4" .....	4	4	4	4	4
203286	Motor water pump shaft bearing retainer gasket .....	x	x	x	x	x
216631	Motor water pump shaft bearing retainer gasket (Supersedes 216331) .....	-	-	x	x	x
203270	Motor water pump shaft bearing spacer .....	1	-	-	-	-

Piece No	Name	No. Required				
		905 906	1005 1006	1107 1108	1207 1208	1407 1408
209068	Motor water pump shaft bearing spacer .....	-	1	1	-	-
221084	Motor water pump shaft bearing spacer .....	-	-	-	1	1
209069	Motor water pump shaft impeller and fan pulley assembly.	-	1	1	-	-
203293	Motor water pump shaft impeller and fan pulley assembly.	1	-	-	-	-
221076	Motor water pump shaft impeller and fan pulley assembly.	-	-	-	1	1
231176	Motor water pump shaft packing (Supersedes 203461) .....	1	1	1	1	1
203460	Motor water pump shaft packing nut .....	1	1	1	1	1

## RADIATOR

98123	Radiator assembly .....	1	-	-	-	-
213478	Radiator assembly (Used on bodies 630-31-39-641-43-47- 730-1-8-9-741-3-7) .....	-	1	1	-	-
213477	Radiator assembly (Used on bodies 633-4-5-6-7-8-5633- 5633-A-732-733-4-5-6-7-D858-D859) .....	-	1	1	-	-
201861	Radiator bonnet ledge liner .....	2	-	-	-	-
201861	Radiator bonnet ledge liner (Used on bodies 630-1-9- 641-3-7-730-1-8-9-741-3-7) .....	-	2	2	-	-
205604	Radiator bonnet ledge liner (Used on bodies 633-4-5-6-7- 8-5633-5633-A-732-3-4-5-6-7-D858-D859) .....	-	2	2	-	-
187260	Radiator bonnet ledge liner hook .....	4	4	4	-	-
7002	Nut No. 8-32 plain .....	4	4	4	-	-
191654	Radiator bonnet ledge liner hook saddle .....	2	2	2	-	-
202670	Radiator cap assembly .....	1	1	-	-	-
215091	Radiator cap assembly .....	-	-	1	-	-
203803	Radiator cap gasket .....	1	1	1	-	-
203809	Radiator cap gasket spring .....	1	1	1	-	-
194829	Radiator cap lock plate .....	1	1	1	-	-
5944	Screw 5/16-18 x 3/8" fill. hd. ....	1	-	-	-	-
6229	Screw 5/16-18 x 1/2" hex. hd. ....	-	1	1	-	-
5504	Lockwasher 5/16" .....	1	1	1	-	-
3874	Washer 5/16" .....	1	-	-	-	-
6359	Washer 5/16" .....	-	1	1	-	-
194831	Radiator cap lock plate gasket .....	1	1	1	-	-
201209	Radiator core and anchorage assembly .....	1	-	-	-	-
205645	Radiator core and anchorage assembly (Used on bodies 633-4-5-6-7-8-5633-5633-A-732-3-4-5-6-7-D858-D859) ...	-	1	1	-	-
207530	Radiator core and anchorage assembly (Used on bodies 630-1-9-641-3-7-730-1-8-9-741-3-7) .....	-	1	1	-	-
190938	Radiator core and anchorage support stud washer .....	2	2	2	-	-
191785	Radiator core and anchorage stud shim .....	-	x	x	-	-
191787	Radiator core and anchorage stud nut-special .....	2	2	2	-	-
4319	Radiator core and anchorage stud nut cotter pin .....	2	2	2	-	-
190939	Radiator core and anchorage stud spacer-upper .....	2	2	2	-	-
191782	Radiator core and anchorage stud spacer-lower .....	2	2	2	-	-
191786	Radiator core and anchorage stud spring .....	2	2	2	-	-
6289	Screw 5/16-24 x 1/2" special .....	-	2	2	-	-
5427	Radiator core to radiator shutter bolt 5/16-24 x 1/2" hex. hd. ....	6	4	4	-	-
5335	Lockwasher 5/16" .....	6	6	6	-	-
171969	Nut .....	-	6	6	-	-
194893	Radiator core to shell liner-side-upper .....	2	-	-	-	-
194893	Radiator core to shell liner-side-upper (Used on bodies 630-1-9-641-3-7-730-1-8-9-41-43-47) .....	-	2	2	-	-
205655	Radiator core to shell liner-side-upper (Used on bodies 633-4-5-6-7-8-5633-5633-A-732-3-4-5-6-7-D858-D859) ...	-	2	2	-	-
194892	Radiator core to shell liner-side-lower .....	2	2	2	-	-
194894	Radiator core to shell liner top .....	2	2	2	-	-
201215	Radiator to dash tie rod left .....	1	-	-	-	-





205962

203517



203499



205972

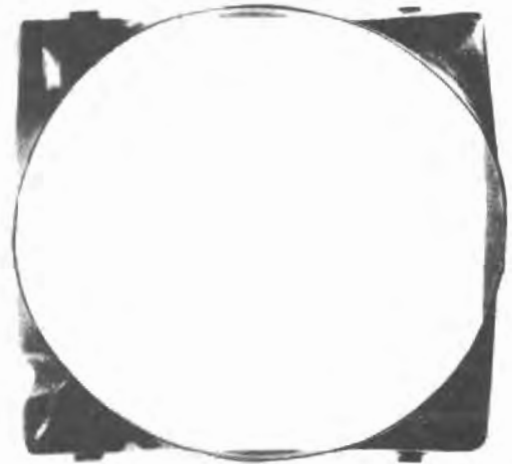

209785-209786



205958



201214-201215-209113-209161



205645

207530

201209



201182-205626

203466-209499

205625-209505

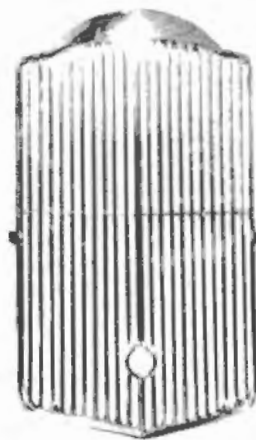

210183

210184



201246-205799

203458-205800

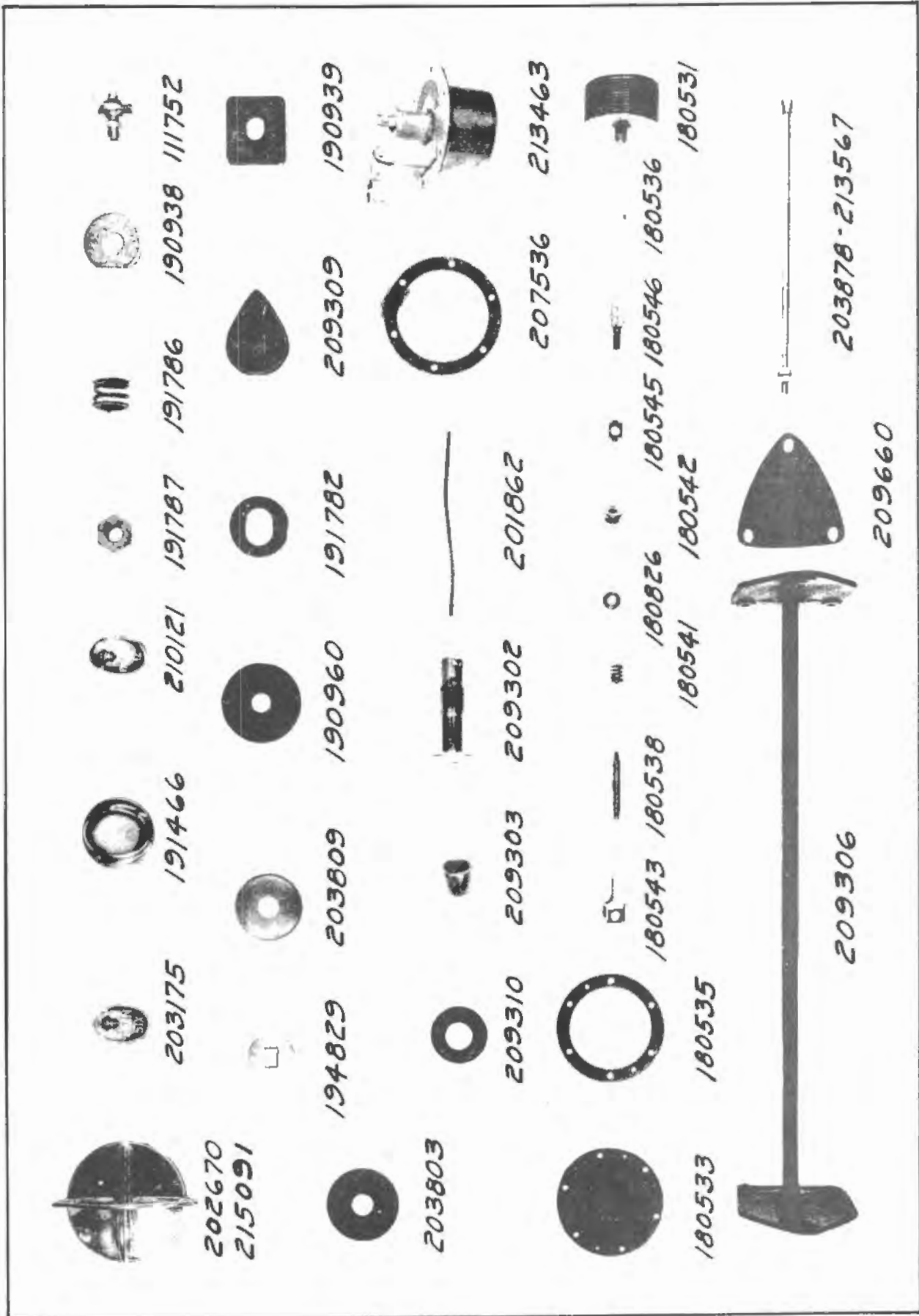

SERVICE PARTS LIST—PACKARD TWELVE

Radiator 145

Piece No.	Name	No. Required				
		905 906	1005 1006	1107 1108	1207 1208	1407 1408
201214	Radiator to dash tie rod right .....	1	-	-	-	-
209161	Radiator to dash tie rod (Used on bodies 630-1-9- 641-3-7-730-1-8-9-741-3-7) .....	-	2	2	-	-
209113	Radiator to dash tie rod (Used on bodies 633-4-5-6-7-8- 5633-5633-A-732-3-4-5-6-7-D858-D859) .....	-	2	2	-	-
6334	Screw 5/16-24 x 1" hex. hd. ....	-	2	-	-	-
6181	Screw 5/16-24 x 1-1/8" hex. hd. ....	1	-	-	-	-
5504	Lockwasher 5/16" .....	1	2	-	-	-
7005	Nut 5/16-24 plain .....	1	2	-	-	-
7010	Nut 5/16-18 .....	4	4	-	-	-
215825	Radiator to dash tie rod bolt .....	-	-	2	-	-
7105	Nut 5/16-24 castle .....	-	-	2	-	-
7010	Nut 5/8-18 .....	-	-	4	-	-
4280	Cotter pin 1/16 x 1/2" .....	-	-	2	-	-
190960	Radiator to dash tie rod washer .....	4	-	-	-	-
197591	Radiator to dash tie rod washer (Used on bodies 630-1-9- 641-3-7-730-1-8-9-41-43-47) .....	-	2	2	-	-
197591	Radiator to dash tie rod washer (Used on bodies 633-4- 5-6-7-8-5633-5633-A-732-3-4-5-6-7-D858-D859) .....	-	4	4	-	-
190960	Radiator to dash tie rod washer (Used on bodies 630-1-9- 641-3-7-730-1-8-9-41-43-47) .....	-	2	2	-	-
5514	Lockwasher 5/8" .....	2	2	2	-	-
111752	Radiator drain cock 1/4" pipe .....	1	1	1	-	-
203517	Radiator expansion tank assembly .....	1	-	-	-	-
205962	Radiator expansion tank assembly .....	-	1	1	-	-
7005	Nut .....	-	-	2	-	-
5504	Lockwasher .....	-	-	2	-	-
7872	Screw 3/8-24 x 3/4" hex. hd. ....	2	-	-	-	-
5506	Lockwasher 3/8" .....	2	-	-	-	-
5242	Radiator expansion tank bracket lower screw 1/4-20 x 5/8" hex. hd. ....	-	-	1	-	-
5937	Washer 1/4" spec. ....	-	-	1	-	-
5502	Lockwasher .....	-	-	1	-	-
203499	Radiator expansion tank elbow .....	1	-	-	-	-
203870	Radiator expansion tank to frame liner .....	1	-	-	-	-
203534	Radiator expansion tank to radiator tube assembly .....	1	-	-	-	-
169042	Union 1/2" flared tube .....	1	-	-	-	-
5468	Union nut 1/4" .....	2	-	-	-	-
162552	Radiator expansion tank to radiator tube clip .....	1	-	-	-	-
3868	Washer 1/4" .....	1	-	-	-	-
205958	Radiator expansion tank to radiator tube hose .....	-	1	1	-	-
205975	Radiator expansion tank to radiator tube hose clamp ....	-	2	2	-	-
205972	Radiator to expansion tank tube assembly .....	-	1	1	-	-
6235	Nut 7/16" .....	-	1	1	-	-
6234	Union connection 7/16" .....	-	1	1	-	-
209785	Radiator fan shroud assembly (Used on bodies 630-1-9- 641-3-7-730-1-8-9-41-43-47) .....	1	1	1	-	-
209786	Radiator fan shroud assembly (Used on bodies 633-4-5-6- 7-8-5633-5633-A-732-3-4-5-6-7-D858-D859) .....	-	1	1	-	-
210184	Radiator guard assembly (closed cars) .....	-	1	-	-	-
210183	Radiator guard assembly (open cars) .....	-	1	-	-	-
201120	Radiator hose-outlet .....	2	-	-	-	-
209357	Radiator hose-outlet .....	-	2	2	-	-
201121	Radiator hose inlet-short .....	1	-	-	-	-
201122	Radiator hose inlet-long .....	1	-	-	-	-
205679	Radiator hose inlet-short (Used on bodies 633-4-5-6-7- 8-5633-5633-A-732-3-4-5-6-7-D858-D859) .....	-	1	1	-	-
201121	Radiator hose inlet-short (Used on bodies 630-1-9- 641-3-7-730-1-8-9-41-43-47) ..	-	1	1	-	-

Piece No.	Name	No. Required				
		905 906	1005 1006	1107 1108	1207 1208	1407 1408
205680	Radiator hose inlet-long (Used on bodies 633-4-5-6-7-8-5633-5633-A-732-3-4-5-6-7-D858-D859) .....	-	1	1	-	-
201122	Radiator hose inlet-long (Used on bodies 630-1-9-641-3-7-730-1-8-9-41-43-47) .....	-	1	1	-	-
207286	Radiator hose inlet spring .....	2	2	2	-	-
142989	Radiator hose clamp-small .....	4	4	4	-	-
201218	Radiator hose clamp-large 2-7/16" dia. ....	4	4	4	-	-
202188	Radiator overflow tube hose .....	1	-	-	-	-
201182	Radiator shell assembly .....	1	-	-	-	-
203466	Radiator shell assembly (Chromium plate) .....	1	-	-	-	-
209499	Radiator shell assembly (Specify color) (Used on bodies 630-1-9-641-3-7-730-1-8-9-41-43-47) .....	-	1	1	-	-
205625	Radiator shell assembly (Specify color) (Used on bodies 633-4-5-6-7-8-5633-5633-A-732-3-4-5-6-7-D858-D859) ...	-	1	1	-	-
205626	Radiator shell assembly (Chromium plate) (Used on bodies 633-4-5-6-7-8-5633-5633-A-732-3-4-5-6-7-D858-D859) ...	-	1	1	-	-
209505	Radiator shell assembly (Chromium plate) (Used on bodies 630-1-9-641-3-7-730-1-8-9-41-43-47) .....	-	1	1	-	-
203347	Radiator shell bonnet ledge guard .....	2	2	-	-	-
6137	Rivet 3/16 x 5/16" countersunk head .....	2	2	-	-	-
209306	Radiator shell brace assembly .....	-	1	1	-	-
209660	Radiator shell brace retainer gasket .....	-	2	2	-	-
197588	Radiator shell brace retainer to flange screw .....	-	6	6	-	-
3874	Washer 5/16" "N" std. ....	-	6	6	-	-
7709	Radiator shell to brace rod screw No. 10-32 x 7/16" fill. hd. ....	-	2	-	-	-
5701	Radiator shell to brace rod screw 1/4-28 x 9/16" flat hd. mach. ....	-	2	-	-	-
8201	Radiator shell to core and anchorage assembly screw 1/4-28 x 5/8" countersunk hd. ....	10	10	10	-	-
5502	Lockwasher 1/4" .....	10	10	6	-	-
3868	Lockwasher 1/4" .....	10	10	6	-	-
7004	Nut 1/4-28 .....	10	10	6	-	-
209310	Radiator shell to lamp front bracket rubber washer (outer) .....	-	2	2	-	-
209309	Radiator shell to lamp front bracket rubber washer (inner) .....	-	2	2	-	-
209302	Radiator shell to lamp front bracket tie rod .....	-	2	2	-	-
209303	Radiator shell to lamp front bracket tie rod nut .....	-	2	2	-	-
191466	Radiator shell motor starting crank hole cover assembly ..	1	1	1	-	-
203175	Radiator shell motor starting crank hole cover emblem ..	1	-	-	-	-
210121	Radiator shell motor starting crank hole cover emblem ..	-	1	1	-	-
5447	Lockwasher 1/4" .....	1	1	1	-	-
191470	Radiator shell motor starting crank hole cover spring ..	1	1	1	-	-
213138	Radiator shell to radiator core liner (Used on bodies 630-1-9-641-3-7-730-1-8-9-41-43-47) .....	-	2	2	-	-
213137	Radiator shell to radiator core liner (Used on bodies 633-4-5-6-7-8-5633-5633-A-732-3-4-5-6-7-D858-D859) ...	-	2	2	-	-
203897	Radiator shell reinforcement channel lower screw .....	1	1	1	-	-
3867	Washer 3/16" plain .....	1	1	1	-	-
5500	Lockwasher 3/16" .....	1	1	1	-	-
7003	Nut No. 10-32 .....	1	1	1	-	-
201669	Radiator shell to thimble gasket .....	-	1	1	-	-
201246	Radiator shutter assembly (Chromium plate) .....	1	-	-	-	-
203458	Radiator shutter assembly (Specify color) .....	1	-	-	-	-
201246	Radiator shutter assembly (Chrome plate) (Used on bodies 630-1-641-3-7-730-1-8-9-41-43-47) .....	-	1	1	-	-
205799	Radiator shutter assembly (Chrome plate) (Used on bodies 633-4-5-6-7-8-5633-5633-A-732-3-4-5-6-7-D858-D859) ...	-	1	1	-	-

Piece No.	Name	No. Required				
		905 906	1005 1006	1107 1108	1207 1208	1407 1408
203458	Radiator shutter assembly (Specify color) (Used on bodies 630-1-9-41-3-7-730-1-8-9-41-3-7) .....	-	1	1	-	-
205800	Radiator shutter assembly (Specify color) (Used on bodies 633-4-5-6-7-8-5633-5633-A-732-3-4-5-6-7-D858-D859) .....	-	1	1	-	-
201862	Radiator shutter bell crank bracket support rod .....	1	1	1	-	-
5500	Lockwasher No. 10 .....	2	2	2	-	-
7003	Nut No. 10-32 .....	4	4	2	-	-
203878	Radiator shutter operating rod yoke end assembly (Not used with adjustable thermostat) .....	1	1	-	-	-
213567	Radiator shutter operating rod yoke end assembly (Used with adjustable thermostat) .....	-	1	1	-	-
184710	Radiator shutter operating rod yoke end .....	1	1	1	-	-
180523	Radiator shutter operating rod yoke end pin .....	1	1	1	-	-
4280	Cotter pin 1/8 x 1/2" .....	1	1	1	-	-
5504	Lockwasher 5/16" .....	1	1	1	-	-
7005	Nut 5/16-24 .....	2	2	2	-	-
5573	Radiator shutter to radiator shell screw No. 10-32 x 1/2 flat hd. spec. ....	4	4	4	-	-
5500	Lockwasher No. 10 .....	4	4	4	-	-
7003	Nut No. 10-32 .....	4	4	4	-	-
177669	Radiator shutter spring (Not used with adjustable thermostat) .....	1	1	-	-	-
213403	Radiator shutter spring (Used with adjustable thermostat) .....	-	1	1	-	-
180531	Radiator shutter thermostat .....	1	-	-	-	-
7008	Nut 1/2-20 .....	1	-	-	-	-
5510	Lockwasher 1/2" .....	1	-	-	-	-
213463	Radiator shutter thermostat and cover assembly .....	-	1	1	-	-
5389	Radiator shutter thermostat cover screw No. 10-32 x 11/32" .....	-	6	6	-	-
180533	Radiator shutter thermostat cover and bushing assembly ..	1	-	-	-	-
180535	Radiator shutter thermostat cover gasket .....	2	-	-	-	-
207536	Radiator shutter thermostat cover gasket .....	-	1	1	-	-
180543	Radiator shutter thermostat lever outer assembly .....	1	-	-	-	-
5502	Lockwasher 1/4" .....	1	-	-	-	-
7004	Nut 1/4-28 .....	1	-	-	-	-
180536	Radiator shutter thermostat lever inner .....	2	-	-	-	-
180538	Radiator shutter thermostat lever shaft .....	1	-	-	-	-
180539	Radiator shutter thermostat lever shaft bushing .....	1	-	-	-	-
180540	Radiator shutter thermostat lever shaft packing 1/8 x 4-1/4" .....	1	-	-	-	-
180541	Radiator shutter thermostat lever shaft packing spring ..	1	-	-	-	-
180542	Radiator shutter thermostat lever shaft packing nut (White nickel) .....	1	-	-	-	-
180826	Radiator shutter thermostat lever shaft packing washer ..	1	-	-	-	-
180537	Radiator shutter thermostat lever spacer .....	1	-	-	-	-
180545	Radiator shutter thermostat lever outer universal .....	1	-	-	-	-
180546	Radiator shutter thermostat push rod .....	1	-	-	-	-
180547	Radiator shutter thermostat push rod end pin .....	1	-	-	-	-
5560	Cotter pin 1/16 x 3/8" .....	1	-	-	-	-
180517	Radiator shutter thermostat push rod nut .....	1	-	-	-	-

RADIATOR *Packard*

223482	Radiator bonnet ledge liner .....	-	-	-	2	-
230450	Radiator bonnet ledge liner .....	-	-	-	-	2
187260	Radiator bonnet ledge liner hook .....	-	-	-	4	4
7002	Nut No. 8-32 .....	-	-	-	4	4

Piece No.	Name	No. Required				
		905 906	1005 1006	1107 1108	1207 1208	1407 1408
191654	Radiator bonnet ledge liner hook saddle .....	-	-	-	2	2
215091	Radiator cap assembly .....	-	-	-	1	1
215090	Radiator cap bail .....	-	-	-	1	1
203782	Radiator cap bail set screw .....	-	-	-	1	1
203803	Radiator cap gasket .....	-	-	-	1	1
203809	Radiator cap gasket spring .....	-	-	-	1	1
194829	Radiator cap lock plate .....	-	-	-	1	1
6229	Screw 5/16-18 x 1/2" hex. hd. ....	-	-	-	1	1
5504	Lockwasher 5/16" .....	-	-	-	1	1
6359	Washer 5/16" special .....	-	-	-	1	1
194831	Radiator cap lock plate gasket .....	-	-	-	1	1
223197	Radiator core and anchorage assembly .....	-	-	-	1	1
223740	Radiator core and anchorage cradle assembly .....	-	-	-	1	1
7007	Nut 7/16" .....	-	-	-	2	2
5508	Lockwasher 7/16" .....	-	-	-	2	2
3883	Washer plain 7/16" .....	-	-	-	2	2
223236	Radiator core and anchorage cradle brace .....	-	-	-	1	1
7608	Bolt 5/16-24 x 3/4" carriage .....	-	-	-	4	4
5504	Lockwasher 5/16" .....	-	-	-	4	4
7005	Nut 5/16-24 .....	-	-	-	4	4
223242	Radiator core and anchorage cradle brace lock .....	-	-	-	1	1
221953	Radiator core and anchorage cradle to frame bolt .....	-	-	-	1	1
223264	Radiator core and anchorage cradle to frame bolt spacer-upper .....	-	-	-	1	1
221978	Radiator core and anchorage cradle to frame bolt spacer-lower .....	-	-	-	1	1
221981	Radiator core and anchorage cradle to frame bolt washer. Nut 1/2-20 castle .....	-	-	-	1	1
7108	Nut 1/2-20 castle .....	-	-	-	1	1
4291	Cotter pin 3/32 x 3/4" .....	-	-	-	1	1
223265	Radiator core and anchorage cradle liner .....	-	-	-	1	1
223472	Radiator core to shell liner side .....	-	-	-	2	2
194894	Radiator core to shell liner top .....	-	-	-	2	2
223473	Radiator core to shell liner-top center .....	-	-	-	1	1
223383	Radiator to dash tie rod (Nickel plate) .....	-	-	-	2	-
230117	Radiator to dash tie rod (Black enamel) .....	-	-	-	2	2
6098	Radiator to dash tie rod bolt 3/8-24 x 1-3/8" hex. hd. (Zinc plate) .....	-	-	-	1	-
6491	Radiator to dash tie rod bolt 3/8-24 x 1-3/8" hex. hd. (Nickel plate) .....	-	-	-	1	1
7006	Nut 3/8-24 .....	-	-	-	1	1
5506	Lockwasher 3/8" .....	-	-	-	1	1
7010	Radiator to dash tie rod nut 5/8-18 .....	-	-	-	4	4
5514	Lockwasher 5/8" .....	-	-	-	2	2
197591	Washer .....	-	-	-	4	4
223302	Radiator to dash tie rod grommet .....	-	-	-	4	4
228908	Radiator to dash tie rod horn bracket front left (Supersedes 225364) .....	-	-	-	1	1
228907	Radiator to dash tie rod horn bracket front right (Supersedes 225364) .....	-	-	-	1	1
7810	Screw 5/16-24 x 1-1/4" hex. hd. ....	-	-	-	2	2
5504	Lockwasher 5/16" .....	-	-	-	2	2
7005	Nut 5/16-24 .....	-	-	-	2	2
228914	Radiator to dash tie rod horn bracket rear assembly- left (Supersedes 225409) .....	-	-	-	1	1
228913	Radiator to dash tie rod horn bracket rear assembly- right (Supersedes 225409) .....	-	-	-	1	1
7810	Screw 5/16-24 x 1-1/4" hex. hd. ....	-	-	-	2	2
5504	Lockwasher 5/16" .....	-	-	-	2	2
7005	Nut 5/16-24 .....	-	-	-	2	2
223461	Radiator to dash tie rod spacer .....	-	-	-	2	2

Piece No.	Name	No. Required				
		905 906	1005 1006	1107 1108	1207 1208	1407 1408
228827	Radiator drain cock (1/4 pipe std.) (Supersedes 203976).	-	-	-	1	1
228823	Radiator drain cock outlet tube .....	-	-	-	1	1
6475	Union nut .....	-	-	-	1	1
225397	Radiator expansion tank assembly .....	-	-	-	1	1
225418	Radiator expansion tank connection tube lockwasher (Shakeproof) .....	-	-	-	1	1
190680	Nut 11/16-16 special .....	-	-	-	1	1
225431	Radiator expansion tank to core connection .....	-	-	-	1	1
5421	Radiator expansion tank drain boss plug 1/8 pipe .....	-	-	-	1	1
205975	Radiator expansion tank to radiator tube hose clamp ....	-	-	-	2	2
5449	Radiator expansion tank retaining screw 5/16-24 x 3/4" hex. hd. ....	-	-	-	2	2
5504	Lockwasher 5/16" .....	-	-	-	2	2
7005	Nut 5/16-24 .....	-	-	-	2	2
225430	Radiator expansion tank tube assembly .....	-	-	-	1	1
6235	Union nut 7/16" flared .....	-	-	-	1	1
225432	Radiator expansion tank tube clip front .....	-	-	-	1	-
162552	Radiator expansion tank tube clip .....	-	-	-	1	1
5873	Screw 1/4-28 x 9/16" hex. hd. ....	-	-	-	1	1
5502	Lockwasher 1/4" .....	-	-	-	1	1
7004	Nut 1/4-28 .....	-	-	-	1	1
223504	Radiator fan shroud assembly .....	-	-	-	1	1
7713	Screw 1/4-28 x 1/2" fill. hd. ....	-	-	-	6	6
7004	Nut 1/4-28 hex. ....	-	-	-	4	4
5502	Lockwasher 1/4" .....	-	-	-	6	6
62065	Washer 1/4" special .....	-	-	-	2	2
205680	Radiator hose-inlet-long .....	-	-	-	1	1
205679	Radiator hose-inlet-short .....	-	-	-	1	1
219933	Radiator hose (outlet) .....	-	-	-	1	1
142989	Radiator hose clamp small .....	-	-	-	4	4
201218	Radiator hose clamp large .....	-	-	-	2	2
207286	Radiator hose spring small .....	-	-	-	2	2
223503	Radiator hose spring large .....	-	-	-	1	1
221233	Radiator shell assembly (Painted) .....	-	-	-	1	-
230177	Radiator shell assembly (Painted) .....	-	-	-	-	1
225971	Radiator shell assembly (Chromium) .....	-	-	-	1	-
230178	Radiator shell assembly (Chromium) .....	-	-	-	-	1
8201	Radiator shell to core and anchorage assembly screw 1/4-28 x 5/8" flat head .....	-	-	-	4	4
6488	Screw 1/4-28 x 5/8" flat head mach. (Conical point).	-	-	-	4	4
5701	Screw 1/4-28 x 9/16" hex. hd. ....	-	-	-	2	2
5502	Lockwasher 1/4" .....	-	-	-	6	6
3868	Washer 1/4" .....	-	-	-	6	6
7004	Nut 1/4-28 .....	-	-	-	6	6
5396	Lockwasher 1/4" Shakeproof .....	-	-	-	4	4
210121	Radiator shell emblem .....	-	-	-	1	1
5447	Lockwasher 1/4" Shakeproof .....	-	-	-	1	1
225500	Radiator shell to fender liner .....	-	-	-	1	-
230223	Radiator shell to fender liner .....	-	-	-	-	1
6497	Radiator shell to fender liner rivet (9/64 x 3/16" flat head tubular) .....	-	-	-	8	8
203897	Radiator shell reinforcement lower screw .....	-	-	-	1	-
3867	Washer 3/16" special .....	-	-	-	1	-
5500	Lockwasher No. 10 .....	-	-	-	1	-
7003	Nut No. 10-32 .....	-	-	-	1	-
201669	Radiator shell to thimble gasket .....	-	-	-	1	1
223135	Radiator shutter assembly (Chromium) .....	-	-	-	1	-
230211	Radiator shutter assembly (Chromium) .....	-	-	-	-	1
225977	Radiator shutter assembly (Painted) .....	-	-	-	1	-
230245	Radiator shutter assembly (Painted) .....	-	-	-	-	1



Piece No.	Name	No. Required				
		905 906	1005 1006	1107 1108	1207 1208	1407 1408
5739	Radiator shutter bell crank bracket support screw No. 10-32 x 1/2" hex. hd. ....	-	-	-	1	1
5500	Lockwasher No. 10 .....	-	-	-	1	1
3866	Washer 3/16" .....	-	-	-	1	1
5427	Radiator shutter to core and cradle bolt .....	-	-	-	6	6
5385	Lockwasher 5/16" Shakeproof .....	-	-	-	6	6
62065	Washer 1/4" plain .....	-	-	-	2	2
223152	Radiator shutter operating rod and yoke end assembly ...	-	-	-	1	-
230429	Radiator shutter operating rod and yoke end assembly ...	-	-	-	-	1
223153	Radiator shutter operating rod .....	-	-	-	1	-
230428	Radiator shutter operating rod .....	-	-	-	-	1
180523	Radiator shutter operating rod yoke end pin .....	-	-	-	1	1
4280	Cotter pin 1/16 x 1/2" .....	-	-	-	1	1
5504	Lockwasher 5/16" .....	-	-	-	1	1
7005	Nut 5/16-24 .....	-	-	-	2	2
5573	Radiator shutter to radiator shell screw No. 10-32 x 1/2 F.H. special .....	-	-	-	4	4
7003	Nut No. 10-32 .....	-	-	-	4	4
5500	Lockwasher No. 10 .....	-	-	-	4	4
225134	Radiator shutter spring .....	-	-	-	1	1
213463	Radiator shutter thermostat and cover assembly .....	-	-	-	1	-
207518	Radiator shutter thermostat and cover assembly .....	-	-	-	-	1
207536	Radiator shutter thermostat cover gasket .....	-	-	-	1	1
5389	Screw No. 10-32 x 7/16" fill. head .....	-	-	-	6	6
5500	Lockwasher No. 10 .....	-	-	-	6	6

### REAR AXLE

(Standard Rear Axle—Not Angle Set)

190523	Rear axle case assembly .....	1	-	-	-	-
190524	Rear axle case to brake assembly stud .....	12	-	-	-	-
190556	Rear axle case to frame assembly long .....	4	-	-	-	-
5508	Lockwasher 7/16" .....	16	-	-	-	-
7007	Nut 7/16-20 plain hex. ....	16	-	-	-	-
194183	Rear axle case cover .....	1	-	-	-	-
5999	Stud 7/16-20 x 1-1/4" .....	10	-	-	-	-
5508	Lockwasher 7/16" .....	10	-	-	-	-
7007	Nut 7/16-20 .....	10	-	-	-	-
107889	Rear axle case cover oil level hole plug .....	1	-	-	-	-
20075	Gasket 1-1/4" .....	1	-	-	-	-
195924	Rear axle case cover gasket .....	1	-	-	-	-
139241	Rear axle case spring seat dowel .....	2	-	-	-	-
197891	Rear axle case ventilator nipple .....	1	-	-	-	-
197890	Rear axle case ventilator nipple cap .....	1	-	-	-	-
138121	Rear axle differential bearing adjusting nut .....	2	-	-	-	-
140067	Rear axle differential bearing adjusting nut lock .....	2	-	-	-	-
4332	Cotter pin 3/16 x 1-1/4" .....	2	-	-	-	-
180750	Rear axle differential bearing adjusting nut lock .....	2	-	-	-	-
4332	Cotter pin 3/16 x 1-1/4" .....	2	-	-	-	-
180750	Rear axle differential bearing assembly .....	2	-	-	-	-
190527	Rear axle differential carrier assembly (5.07 to 1 ratio)	1	-	-	-	-
190528	Rear axle differential carrier assembly (4.41 to 1 ratio)	1	-	-	-	-
190529	Rear axle differential carrier assembly (4.06 to 1 ratio)	1	-	-	-	-
191642	Rear axle differential carrier assembly (4.69 to 1 ratio)	1	-	-	-	-
194459	Rear axle differential carrier and cap assembly .....	1	-	-	-	-
191552	Rear axle differential carrier cap .....	2	-	-	-	-
196849	Stud .....	4	-	-	-	-
7108	Nut 1/2-20 castle .....	4	-	-	-	-
4291	Cotter pin 3/32 x 3/4" .....	4	-	-	-	-

SERVICE PARTS LIST—PACKARD TWELVE

Rear Axle 151

Part No.	Name	No. Required				
		905 906	1005 1006	1107 1108	1207 1208	1407 1408
196807	washer .....	4	-	-	-	-
45933	Rear axle differential carrier cap stud gasket .....	4	-	-	-	-
196808	Rear axle differential carrier cap spacer nut .....	4	-	-	-	-
141345	Rear axle differential carrier to rear axle case gasket.	1	-	-	-	-
5998	Rear axle differential carrier to rear axle case stud 7/16-20 x 1-5/8" .....	10	-	-	-	-
5508	Lockwasher 7/16" .....	10	-	-	-	-
7007	Nut 7/16-20 .....	10	-	-	-	-
180751	Rear axle differential case assembly .....	1	-	-	-	-
118196	Rear axle differential case stud 3/8-24 x 2" special ...	8	-	-	-	-
7106	Nut 3/8-24 castle .....	8	-	-	-	-
120813	Rear axle differential case stud lockwire 6" long .....	4	-	-	-	-
141459	Rear axle differential driving gear and pinion assembly (4.06 to 1 ratio) (69-17 teeth) .....	1	-	-	-	-
141903	Rear axle differential driving gear and pinion assembly (4.41 to 1 ratio) (75-17 teeth) .....	1	-	-	-	-
184410	Rear axle differential driving gear and pinion assembly (5.07 to 1 ratio) (71-14 teeth) .....	1	-	-	-	-
141460	Rear axle differential driving gear and pinion assembly (4.69 to 1 ratio) (75-16 teeth) .....	1	-	-	-	-
194182	Rear axle differential driving gear screw .....	16	-	-	-	-
120813	Lockwire 8" long .....	8	-	-	-	-
138908	Rear axle differential driving pinion bearing front (Hess Bright No. 6909) .....	1	-	-	-	-
138584	Rear axle differential driving pinion bearing front dust washer and retainer assembly .....	1	-	-	-	-
111538	Rear axle differential driving pinion bearing front dust washer .....	1	-	-	-	-
138153	Rear axle differential driving pinion bearing front nut.	1	-	-	-	-
173333	Rear axle differential driving pinion bearing front lock	1	-	-	-	-
138147	Rear axle differential driving pinion bearing front oil impeller assembly .....	1	-	-	-	-
141358	Rear axle differential driving pinion bearing rear (Hess Bright No. 6905) .....	1	-	-	-	-
190507	Rear axle differential driving pinion bearing sleeve- front .....	1	-	-	-	-
7822	Screw 3/8-24 x 1-1/2" hex. hd. ....	8	-	-	-	-
7820	Screw 3/8-24 x 1-3/8" hex. hd. ....	8	-	-	-	-
5506	Lockwasher 3/8" .....	8	-	-	-	-
190516	Rear axle differential driving pinion bearing front sleeve shim thick .....	x	-	-	-	-
190517	Rear axle differential driving pinion bearing front sleeve shim thin .....	x	-	-	-	-
190518	Rear axle differential driving pinion bearing front sleeve shim medium .....	x	-	-	-	-
138154	Rear axle differential driving pinion flange .....	1	-	-	-	-
127273	Nut 3/4-16 castle .....	1	-	-	-	-
4320	Cotter pin 5/32 x 1-1/8" .....	1	-	-	-	-
138155	Rear axle differential driving pinion flange spacer ....	1	-	-	-	-
140079	Rear axle differential driving pinion flange washer ....	1	-	-	-	-
140422	Rear axle differential driving pinion oil thrower .....	1	-	-	-	-
186501	Rear axle differential gear .....	2	-	-	-	-
143459	Rear axle differential gear thrust washer .....	2	-	-	-	-
4724	Dowel pin 3/16 x 1/2" .....	4	-	-	-	-
143460	Shim (.005) thick .....	x	-	-	-	-
143461	Shim (.006) thick .....	x	-	-	-	-
143462	Shim (.007) thick .....	x	-	-	-	-
143463	Shim (.017) thick .....	x	-	-	-	-
124617	Rear axle differential pinion .....	4	-	-	-	-
124618	Rear axle differential pinion spider .....	1	-	-	-	-

Piece No.	Name	No. Required				
		905 906	1005 1006	1107 1108	1207 1208	1407 1408
190546	Rear axle shaft .....	2	-	-	-	-
4334	Rear axle shaft cotter pin 3/16 x 1-3/4" .....	2	-	-	-	-
140073	Rear axle shaft key 1/4 x 1/4 x 3-1/2" .....	2	-	-	-	-
124631	Rear axle shaft nut .....	2	-	-	-	-
3896	Rear axle shaft washer 1" plain .....	2	-	-	-	-
62580	Rear axle shaft bearing (Hess Bright No. 6310) .....	2	-	-	-	-
120813	Lockwire 8" long .....	2	-	-	-	-
138600	Rear axle shaft bearing check nut .....	2	-	-	-	-
138602	Rear axle shaft bearing check nut lockwasher .....	2	-	-	-	-
138624	Screw 5/16-24 x 3/4" hex. hd. spec. ....	4	-	-	-	-
185436	Rear axle shaft bearing retainer and oil seal assembly .	2	-	-	-	-
144217	Rear axle shaft bearing shim .....	X	-	-	-	-
163205	Rear axle shaft bearing sleeve .....	2	-	-	-	-
124635	Rear axle shaft bearing sleeve dust washer .....	2	-	-	-	-
124715	Rear axle shaft bearing sleeve dust washer retainer ....	2	-	-	-	-

### REAR AXLE (Angle Sct)

196701	Rear axle case assembly .....	1	1	1	-	-
221720	Rear axle case assembly .....	-	-	-	1	1
196708	Rear axle case cover .....	1	1	1	1	1
5999	Stud 7/16-20 x 1-1/4" .....	8	8	8	8	8
5508	Lockwasher 7/16" .....	8	8	8	8	8
7007	Nut 7/16-20 .....	8	8	8	8	8
201259	Rear axle case cover gasket .....	1	1	1	1	1
139241	Rear axle case spring seat dowel .....	2	2	2	2	2
232960	Rear axle case ventilator assembly (Supersedes 197890- 197891) .....	1	1	1	1	1
138121	Rear axle differential bearing adjusting nut .....	2	2	2	2	2
140087	Rear axle differential bearing adjusting nut lock .....	2	2	2	2	2
4332	Cotter pin 3/16 x 1-1/4" .....	2	2	2	2	2
180750	Rear axle differential bearing assembly .....	2	2	2	2	2
196728	Rear axle differential carrier assembly (5.07 to 1 ratio)	1	1	1	-	-
196729	Rear axle differential carrier assembly (4.41 to 1 ratio)	1	1	1	-	-
196730	Rear axle differential carrier assembly (4.06 to 1 ratio)	1	1	1	-	-
196731	Rear axle differential carrier assembly (4.69 to 1 ratio)	1	1	1	-	-
219524	Rear axle differential carrier assembly (4.41 to 1 ratio)	-	-	-	1	1
219525	Rear axle differential carrier assembly (4.69 to 1 ratio)	-	-	-	1	1
219526	Rear axle differential carrier assembly (4.06 to 1 ratio)	-	-	-	1	1
203886	Rear axle differential carrier and cap assembly .....	1	1	1	1	1
196709	Rear axle differential carrier cap .....	2	2	2	2	2
196849	Stud .....	4	4	4	4	4
7108	Nut 1/2-20 castle .....	4	4	4	4	4
4291	Cotter pin 3/32 x 3/4" .....	4	4	4	4	4
196807	Washer .....	4	4	4	4	4
45933	Rear axle differential carrier cap stud gasket .....	4	4	4	4	4
196808	Rear axle differential carrier cap spacer nut .....	4	4	4	4	4
201260	Rear axle differential carrier to rear axle case gasket.	1	1	1	1	1
5998	Rear axle differential carrier to rear axle case stud 7/16-20 x 1-5/8" .....	8	8	8	8	8
5508	Lockwasher 7/16" .....	8	8	8	8	8
7007	Nut 7/16-20 .....	8	8	8	8	8
107889	Rear axle differential carrier oil plug .....	2	2	2	2	2
20075	Gasket 1-1/4" annular .....	2	2	2	2	2
201253	Rear axle differential carrier stud .....	2	2	2	2	2
3912	washer 7/16" plain .....	2	2	2	2	2
7107	Nut 7/16-20 castle .....	2	2	2	2	2
4291	Cotter pin 3/32 x 3/4" .....	2	2	2	2	2

SERVICE PARTS LIST—PACKARD TWELVE

Rear Axle 133

Piece No.	Name	No. Required				
		905 906	1005 1006	1107 1108	1207 1208	1407 1408
203882	Rear axle differential case assembly .....	1	-	-	-	-
205836	Rear axle differential case assembly .....	-	1	1	1	-
196741	Rear axle differential case stud .....	8	8	8	8	8
7106	Nut 3/8-24 castle .....	8	8	8	8	8
120813	Rear axle differential case stud lockwire 6" long .....	4	4	4	4	4
141459	Rear axle differential driving gear and pinion assembly (4.06 to 1 ratio) (69-17 teeth) .....	1	1	1	1	1
141903	Rear axle differential driving gear and pinion assembly (4.41 to 1 ratio) (75-17 teeth) .....	1	1	1	1	1
184410	Rear axle differential driving gear assembly (5.07 to 1 ratio) (71-14 teeth) .....	1	1	1	-	-
141460	Rear axle differential driving gear and pinion assembly (4.69 to 1 ratio) (75-16 teeth) .....	1	1	1	1	1
194182	Rear axle differential driving gear screw .....	16	16	16	16	16
120813	Lockwire 8" long .....	8	8	8	8	8
196739	Rear axle differential driving pinion adjusting shim- thin .....	x	x	x	x	x
196740	Rear axle differential driving pinion adjusting shim- medium .....	x	x	x	x	x
196738	Rear axle differential driving pinion adjusting shim- thick .....	x	x	x	x	x
196726	Rear axle differential driving pinion bearing front (Hess Bright No. 6909) .....	1	1	1	1	1
197116	Rear axle differential driving pinion bearing front dust shield .....	1	1	1	1	1
197117	Rear axle differential driving pinion bearing front dust shield washer .....	1	1	1	-	-
197118	Rear axle differential driving pinion bearing dust shield washer retainer .....	1	1	1	-	-
196720	Rear axle differential driving pinion bearing front gasket .....	1	1	1	1	1
141358	Rear axle differential driving pinion bearing rear (Hess Bright No. 6905) .....	1	1	1	1	1
210473	Rear axle differential driving pinion bearing front oil filter assembly .....	-	1	1	1	1
210058	Rear axle differential driving pinion bearing rear oil filter assembly .....	-	1	1	1	1
186083	Rear axle differential driving pinion bearing front oil seal .....	1	1	1	-	-
221290	Rear axle differential driving pinion bearing front oil seal .....	-	-	-	1	1
196721	Rear axle differential driving pinion bearing front retainer .....	1	1	1	1	1
7801	Screw 1/4-28 x 11/16" .....	2	2	-	-	-
6011	Screw 1/4-28 x 11/16" hex. hd. ....	-	-	2	2	2
5502	Lockwasher washer 1/4" .....	2	2	2	2	2
196735	Rear axle differential driving pinion bearing front spacer .....	1	1	1	1	1
210481	Rear axle differential driving pinion bearing rear oil thrower .....	-	1	1	1	1
196719	Rear axle differential driving pinion bearing sleeve- front .....	1	1	1	1	1
7822	Screw 3/8-24 x 1-1/2" hex. hd. ....	8	8	8	8	8
5506	Lockwasher 3/8" .....	8	8	8	8	8
196722	Rear axle differential driving pinion universal joint flange (Prior to Frame No. 901372 for 1005 and 901381 for 1006) .....	1	1	-	-	-
209188	Rear axle differential driving pinion universal joint flange (After Frame No. 901371 and 901380) (Square Flange) .....	-	1	1	-	-

Piece No.	Name	No. Required				
		905 906	1005 1006	1107 1108	1207 1208	1407 1408
219209	Rear axle differential driving pinion universal joint flange (Round Flange) .....	-	-	1	1	1
127273	Nut 3/4-16 castle .....	1	1	1	1	1
4320	Cotter pin 5/32 x 1-1/8" .....	1	1	1	1	1
140079	Rear axle differential driving pinion universal joint flange washer .....	1	1	1	1	1
186501	Rear axle differential gear .....	2	2	2	2	2
143459	Rear axle differential gear thrust washer .....	2	2	2	2	2
4724	Dowel pin 3/16 x 1/2" .....	4	4	4	4	4
143460	Shim (.005) thick .....	x	x	x	-	-
143461	Shim (.006) thick .....	x	x	x	-	-
143462	Shim (.007) thick .....	x	x	x	-	-
143463	Shim (.017) thick .....	x	x	x	-	-
124617	Rear axle differential pinion .....	4	4	4	4	4
124618	Rear axle differential pinion spider .....	1	1	1	1	1
203710	Rear axle shaft-left .....	1	1	1	-	-
221719	Rear axle shaft-left .....	-	-	-	1	1
203711	Rear axle shaft-right .....	1	1	1	-	-
221718	Rear axle shaft-right .....	-	-	-	1	1
4334	Rear axle shaft cotter pin 3/16 x 1-3/4" .....	2	2	2	2	2
140073	Rear axle shaft key 1/4 x 1/4 x 3-1/2" .....	2	2	2	2	2
124631	Rear axle shaft nut .....	2	2	2	2	2
3896	Rear axle shaft washer 1" plain .....	2	2	2	2	2
205684	Rear axle shaft bearing assembly .....	4	4	4	4	4
4559	Rear axle shaft bearing oil hole plug .....	-	-	2	2	2
196742	Rear axle shaft bearing oil seal-inner .....	2	2	2	2	2
203718	Rear axle shaft bearing oil seal-outer .....	2	-	-	-	-
196737	Rear axle shaft bearing oil seal-outer .....	-	2	2	2	2
203734	Rear axle shaft bearing shim (.003) .....	x	x	x	x	x
196743	Rear axle shaft bearing shim (.005) .....	x	x	x	x	x
203735	Rear axle shaft bearing shim (.008) .....	x	x	x	x	x
203736	Rear axle shaft bearing shim (.016) .....	x	x	x	x	x
203712	Rear axle shaft bearing sleeve .....	2	-	-	-	-
196700	Rear axle shaft bearing sleeve .....	-	2	2	2	2
196718	Rear axle shaft bearing sleeve clamp ring .....	2	2	2	2	2
5929	Screw 7/16-20 x 1-19/32" .....	12	16	16	16	16
203730	Stud 7/16 x 3-3/16" special .....	4	-	-	-	-
5508	Lockwasher 7/16" .....	16	16	16	16	16
7007	Nut 7/16-20 plain .....	4	4	4	-	-

### RUNNING BOARD

202992	Running board-left assembly (White tread strips) (Used on 905 only) .....	1	-	-	-	-
190300	Running board-left assembly (Black tread strips) (Used on 905 only) .....	1	-	-	-	-
202994	Running board-left assembly (White tread strips) (Used on 906 only) .....	1	-	-	-	-
190298	Running board-left assembly (Black tread strips) (Used on 906 only) .....	1	-	-	-	-
205298	Running board-left assembly (Used on 1005 only) .....	-	1	-	-	-
215716	Running board-left assembly (Used on 1107 only) .....	-	-	1	-	-
205296	Running board-left assembly (Used on 1006 only) .....	-	1	-	-	-
215714	Running board-left assembly (Used on 1108 only) .....	-	-	1	-	-
202993	Running board-right assembly (White tread strips) (Used on 905 only) .....	1	-	-	-	-
190301	Running board-right assembly (Black tread strips) (Used on 905 only) .....	1	-	-	-	-
202995	Running board-right assembly (White tread strips) (Used on 906 only) .....	1	-	-	-	-

Piece No.	Name	No. Required				
		905 906	1005 1006	1107 1108	1207 1208	1407 1408
190299	Running board-right assembly (Black tread strips) (Used on 906 only) .....	1	-	-	-	-
205299	Running board-right assembly (Used on 1005 only) .....	-	1	-	-	-
215717	Running board-right assembly (Used on 1107 only) .....	-	-	1	-	-
205297	Running board-right assembly (Used on 1006 only) .....	-	1	-	-	-
215715	Running board-right assembly (Used on 1108 only) .....	-	-	1	-	-
186963	Running board bracket .....	4	-	-	-	-
209524	Running board bracket-front right .....	-	1	1	-	-
201963	Running board bracket-front left .....	-	1	1	-	-
209524	Running board bracket-center .....	-	2	2	-	-
209525	Running board bracket-rear .....	-	2	-	-	-
5449	Screw 5/16-24 x 3/4" hex. hd. (Used on 1005-1107) ..	-	4	4	-	-
5504	Lockwasher 5/16" (Used on 1005-1107) .....	-	4	4	-	-
7005	Nut 5/16-24 (Used on 1005-1107) .....	-	4	4	-	-
4175	Rivet 5/16 x 7/8" rnd. hd. ....	16	24	-	-	-
4176	Rivet 5/16 x 1" rnd. hd. ....	8	-	-	-	-
7600	Running board to bracket bolt 5/16 x 7/8" carriage .....	12	12	12	-	-
5504	Lockwasher 5/16" .....	12	12	12	-	-
7005	Nut 5/16-24 plain .....	12	12	12	-	-
3874	Washer 5/16" plain .....	12	12	12	-	-
216915	Running board to bracket liner .....	-	-	6	-	-
185031	Running board light door switch (Used on bodies 579-639)	2	2	-	-	-
190317	Running board and mat assembly-right (Used on 905 only).	1	-	-	-	-
190318	Running board and mat assembly-right (Used on 906 only).	1	-	-	-	-
205286	Running board and mat assembly-right (Used on 1005 only)	-	1	-	-	-
205284	Running board and mat assembly-right (Used on 1006 only)	-	1	-	-	-
190319	Running board and mat assembly-left (Used on 905 only) .	1	-	-	-	-
190320	Running board and mat assembly-left (Used on 906 only) .	1	-	-	-	-
205285	Running board and mat assembly-left (Used on 1005 only).	-	1	-	-	-
205283	Running board and mat assembly-left (Used on 1006 only).	-	1	-	-	-
215586	Running board and mat assembly-right (Used on 1107) ....	-	-	1	-	-
215584	Running board and mat assembly-right (Used on 1108) ....	-	-	1	-	-
215587	Running board and mat assembly-left (Used on 1107) .....	-	-	1	-	-
215585	Running board and mat assembly-left (Used on 1108) .....	-	-	1	-	-
215705	Running board moulding-front right .....	-	-	1	-	-
215704	Running board moulding-front left .....	-	-	1	-	-
194223	Running board moulding-front right .....	1	1	-	-	-
194224	Running board moulding-front left .....	1	1	-	-	-
194220	Running board moulding-rear left .....	1	-	-	-	-
205279	Running board moulding-rear left .....	-	1	-	-	-
215707	Running board moulding-rear left .....	-	-	1	-	-
194221	Running board moulding-rear right .....	1	-	-	-	-
205280	Running board moulding-rear right .....	-	1	-	-	-
215708	Running board moulding-rear right .....	-	-	1	-	-
8212	Running board moulding front and rear screw No. 10-32 x 7/16" flat head .....	8	8	8	-	-
5500	Lockwasher No. 10 .....	8	8	8	-	-
7003	Nut No. 10-32 plain .....	8	8	8	-	-
194229	Running board moulding inboard-left (Used on 905 only) .	1	-	-	-	-
194231	Running board moulding inboard-left (Used on 906 only) .	1	-	-	-	-
207208	Running board moulding inboard-left (Used on 1005-1107).	-	1	1	-	-
207210	Running board moulding inboard-left (Used on 1006-1108).	-	1	1	-	-
194232	Running board moulding inboard-right (Used on 906 only).	1	-	-	-	-
194230	Running board moulding inboard-right (Used on 905 only).	1	-	-	-	-
207209	Running board moulding inboard-right (Used on 1005-1107)	-	1	1	-	-
207211	Running board moulding inboard-right (Used on 1006-1108)	-	1	1	-	-
77082	Running board moulding inboard rivet .....	8	8	8	-	-
190827	Running board moulding outboard-left (Used on 905-1005 only) .....	1	1	-	-	-
190828	Running board moulding outboard-left (Used on 906-1006 only) .....	1	1	-	-	-

Piece No.	Name	No. Required				
		905 906	1001 1006	1107 1108	1207 1208	1407 1408
190829	Running board moulding outboard-right (Used on 905-1005 only) .....	1	1	-	-	-
190830	Running board moulding outboard-right (Used on 906-1006 only) .....	1	1	-	-	-
215801	Running board moulding-outboard (Used on 1107) .....	-	-	2	-	-
215800	Running board moulding-outboard (Used on 1108) .....	-	-	2	-	-
215669	Bolt No. 10-32 x 1/2" .....	-	-	24	-	-
7003	Nut No. 10-32 .....	-	-	24	-	-
5500	Lockwasher 3/16" .....	-	-	24	-	-
3866	Washer 3/16" .....	-	-	24	-	-
5308	Bolt 1/4-28 x 1/2" special .....	14	14	-	-	-
7004	Nut 1/4-28 plain .....	14	14	-	-	-
5502	Lockwasher 1/4" .....	14	14	-	-	-
202990	Running board tread strip (White) (Used on 905 only) ...	8	-	-	-	-
190802	Running board tread strip (Black) (Used on 905-1005 only) .....	8	8	-	-	-
202991	Running board tread strip (White) (Used on 906 only) ...	8	-	-	-	-
190803	Running board tread strip (Black) (Used on 906-1006 only) .....	8	8	-	-	-
215673	Running board tread strip (Used on 1108) .....	-	-	2	-	-
215674	Running board tread strip (Used on 1107) .....	-	-	2	-	-
215703	Running board tread tip .....	-	-	2	-	-
182252	Running board tread tip .....	16	16	-	-	-
7729	Screw No. 10-32 x 11/32" F.H. ....	16	16	-	-	-
8212	Screw No. 10-32 x 7/16" flat head .....	-	-	2	-	-
7003	Nut No. 10-32 .....	-	-	2	-	-
5500	Lockwasher No. 10 .....	16	16	2	-	-
203120	Running board trim strip assembly (With white tread strips) (Used on 905 only) .....	8	-	-	-	-
190093	Running board trim strip assembly (With black tread strips) (Used on 905-1005 only) .....	8	8	-	-	-
203121	Running board trim strip assembly (With white tread strips) (Used on 906 only) .....	8	-	-	-	-
190094	Running board trim strip assembly (With black tread strips) (Used on 906-1006 only) .....	8	8	-	-	-
215731	Running board trim strip assembly (Used on 1107) .....	-	-	2	-	-
215730	Running board trim strip assembly (Used on 1108) .....	-	-	2	-	-

### RUNNING BOARD

228761	Running board left assembly-complete (Specify color) (Used on 1207-1407) .....	-	-	-	1	1
228762	Running board left assembly-complete (Specify color) (Used on 1208-1408) .....	-	-	-	1	1
228767	Running board right assembly-complete (Specify color) (Used on 1207-1407) .....	-	-	-	1	1
228768	Running board right assembly-complete (Specify color) (Used on 1208-1408) .....	-	-	-	1	1
223905	Running board to body liner (Specify color) (Used on 1207-1407) .....	-	-	-	2	2
223906	Running board to body liner (Specify color) (Used on 1208-1408) .....	-	-	-	2	2
21964	Rivet No. 632-3/64 x 5/16" tub. ....	-	-	-	28	48
223822	Running board bracket front assembly .....	-	-	-	2	2
4174	Rivet 5/16 x 3/4" round hd. ....	-	-	-	2	2
209524	Running board bracket-center .....	-	-	-	2	2
209525	Running board bracket rear .....	-	-	-	2	2
4175	Running board bracket to frame rivet 5/16 x 7/8" rnd. hd	-	-	-	18	-
5449	Running board bracket bolt 5/16-24 x 3/4" hex. hd. ....	-	-	-	22	22



SERVICE PARTS LIST—PACKARD TWELVE

Piece No.	Name	No. Required				
		905 906	1005 1006	1107 1108	1207 1208	1407 1408
5504	Lockwasher 5/16" .....	-	-	-	22	22
7005	Nut 5/16-24 .....	-	-	-	22	22
5449	Running board bracket to frame screw 5/16-24 x 3/4" hex. hd. ....	-	-	-	8	8
5504	Lockwasher 5/16" .....	-	-	-	8	8
7005	Nut 5/16-24 .....	-	-	-	8	8
7600	Running board to bracket bolt 5/16-24 x 7/8" carriage ..	-	-	-	12	12
5504	Lockwasher 5/16" .....	-	-	-	12	12
3874	Washer 5/16" .....	-	-	-	12	12
7005	Nut 5/16-24 .....	-	-	-	12	12
216915	Running board to bracket liner .....	-	-	-	6	6
223632	Running board mat assembly right (Used on 1207-1407) ...	-	-	-	1	1
223630	Running board mat assembly right (Used on 1208-1408) ...	-	-	-	1	1
223633	Running board mat assembly left (Used on 1207-1407) ....	-	-	-	1	1
223631	Running board mat assembly left (Used on 1208-1408) ....	-	-	-	1	1
*223971	Running board moulding inboard right (Used on 1207) ....	-	-	-	1	-
*223972	Running board moulding inboard left (Used on 1207) ....	-	-	-	1	-
*223975	Running board moulding inboard right (Used on 1208) ....	-	-	-	1	-
*223976	Running board moulding inboard left (Used on 1208) ....	-	-	-	1	-
*223993	Running board moulding outboard left (Used on 1207) ....	-	-	-	1	-
*223994	Running board moulding outboard right (Used on 1207) ...	-	-	-	1	-
*223997	Running board moulding outboard left (Used on 1208) ....	-	-	-	1	-
*223998	Running board moulding outboard right (Used on 1208) ...	-	-	-	1	-
**228734	Running board moulding (Used on 1207-1407) .....	-	-	-	4	4
**228735	Running board moulding (Used on 1208-1408) .....	-	-	-	4	4
228714	Running board moulding front right (die casting) .....	-	-	-	1	1
228713	Running board moulding front left (die casting) .....	-	-	-	1	1
228712	Running board moulding rear left (die casting) .....	-	-	-	1	1
228711	Running board moulding rear right (die casting) .....	-	-	-	1	1
223925	Running board moulding clip (Used with formed end mouldings) .....	-	-	-	4	-
183962	Running board moulding clip cup washer (Used with formed end mouldings) .....	-	-	-	4	-
3774	Lockwasher No. 8 (Used with formed end mouldings) ..	-	-	-	4	-
5195	Screw No. 8 x 3/8" round hd. (Used with formed end mouldings) .....	-	-	-	4	-
183962	Running board moulding cup washer (Use with straight moulding) .....	-	-	-	24	24
5500	Lockwasher (Use with straight moulding) .....	-	-	-	24	24
5935	Lockwasher No. 10 Shakeproof .....	-	-	-	-	24
5840	Screw No. 10-24 x 13/32" fill. hd. (Use with straight moulding) .....	-	-	-	24	24
225681	Running board moulding screw .....	-	-	-	x	x
101200	Washer plain 13/64 x 5/8 x 1/32" .....	-	-	-	x	-
5500	Lockwasher No. 10 .....	-	-	-	x	-
7003	Nut No. 10-32 .....	-	-	-	x	x
5935	Lockwasher No. 10 Shakeproof .....	-	-	-	x	-
6587	Lockwasher 3/16" Shakeproof special .....	-	-	-	-	x
223878	Running board screw bracket front left .....	-	-	-	1	1
223879	Running board screw bracket front right .....	-	-	-	1	1

\*\*These mouldings are straight and are used with die cast end moulding.

\*These mouldings include formed ends extending to center of running board and are fastened with a clip.

Piece No.	Name	No. Required				
		905 906	1005 1006	1107 1108	1207 1208	1407 1408
<b>SHOCK ABSORBER</b>						
191257	Shock absorber assembly-front left .....	1	-	-	-	-
191256	Shock absorber assembly-front right .....	1	-	-	-	-
209585	Shock absorber assembly-front right .....	-	1	1	-	-
209584	Shock absorber assembly-front left .....	-	1	1	-	-
210046	Shock absorber assembly-rear left .....	-	1	1	-	-
210045	Shock absorber assembly-rear right .....	-	1	1	-	-
194238	Shock absorber assembly-rear left .....	1	-	-	-	-
194237	Shock absorber assembly-rear right .....	1	-	-	-	-
213819	Shock absorber rear right assembly (Side wheel carrier) ..	-	1	1	-	-
213818	Shock absorber rear left assembly (Side wheel carrier) ..	-	1	1	-	-
203080	Shock absorber control connecting rod front-left front ..	1	-	-	-	-
203081	Shock absorber control connecting rod front-left rear ..	1	-	-	-	-
203082	Shock absorber control connecting rod front-left rear ..	1	-	-	-	-
194037	Shock absorber control connecting rod front-right (Used on 905 only) .....	1	-	-	-	-
194050	Shock absorber control connecting rod front-right (Used on 906 only) .....	1	-	-	-	-
209614	Shock absorber control connecting rod front-left .....	-	1	1	-	-
209613	Shock absorber control connecting rod front-right .....	-	1	1	-	-
114775	Ball joint .....	4	-	-	-	-
7513	Yoke end 3/16" .....	4	-	-	-	-
7003	Nut 3/16" .....	8	-	-	-	-
7523	Yoke end pin .....	4	-	-	-	-
190192	Spring washer 3/16" .....	4	-	-	-	-
4280	Cotter pin 1/16 x 1/2" .....	4	-	-	-	-
5500	Lockwasher 3/16" .....	2	-	-	-	-
197903	Yoke end adj. ....	-	2	2	2	-
197910	Yoke end pin-short .....	-	1	1	-	-
190045	Yoke end pin lock .....	-	1	1	-	-
201838	Shock absorber control connecting rod front nut .....	-	4	4	-	-
197949	Nut No. 5-40 plain .....	-	4	4	-	-
3516	Lockwasher No. 6 .....	-	4	4	-	-
197895	Ball joint .....	-	2	2	-	-
7003	Nut 3/16" .....	-	2	2	-	-
5500	Lockwasher 3/16" .....	-	2	2	-	-
197916	Shock absorber control connecting rod front anti-rattler assembly front .....	-	2	2	-	-
210755	Shock absorber control connecting rod anti-rattler assembly-front right intermediate .....	-	1	1	-	-
7801	Screw 1/4-28 x 1/2" hex. hd. ....	-	1	1	-	-
5502	Lockwasher 1/4" .....	-	1	1	-	-
197914	Shock absorber control connecting rod front anti-rattler bracket front right rear assembly .....	-	1	1	-	-
209867	Shock absorber control connecting rod front intermediate anti-rattler bracket assembly .....	-	1	1	-	-
209615	Shock absorber control connecting rod intermediate- front .....	-	1	1	-	-
197903	Yoke end adj. ....	-	2	2	-	-
197910	Yoke end pin-short .....	-	1	1	-	-
190045	Yoke end pin lock .....	-	1	1	-	-
201838	Shock absorber control connecting rod intermediate front nut .....	-	2	2	-	-
3516	Lockwasher No.6 .....	-	2	2	-	-
197949	Nut No. 5-40 plain .....	-	2	2	-	-
209738	Shock absorber control connecting rod-rear (Used on 1005-1107) .....	-	2	2	-	-
209656	Shock absorber control connecting rod-rear (Used on 1006-1108) .....	-	2	2	-	-

Piece No.	Name	No. Required				
		905 906	1005 1006	1107 1108	1207 1208	1407 1408
191992	Shock absorber control connecting rod rear .....	2	-	-	-	-
114775	Ball joint .....	2	-	-	-	-
7513	Yoke end 3/16" .....	2	-	-	-	-
7523	Yoke end pin .....	2	-	-	-	-
190192	Spring washer 3/16" .....	2	-	-	-	-
4280	Cotter pin 1/16 x 1/2" .....	2	-	-	-	-
7003	Nut 3/16" plain .....	6	-	-	-	-
5500	Lockwasher 3/16" .....	2	-	-	-	-
197910	Shock absorber control connecting rod-rear yoke end pin-short .....	-	2	2	-	-
197911	Shock absorber control connecting rod-rear yoke end pin-long .....	-	2	2	-	-
190045	Pin lock .....	-	4	4	-	-
197903	Yoke end adj. ....	-	4	4	-	-
201838	Shock absorber control connecting rod rear nut .....	-	4	4	-	-
3516	Lockwasher No. 6 std. ....	-	4	4	-	-
197949	Nut No. 5-40 plain .....	-	4	4	-	-
209741	Shock absorber control connecting rod rear anti-rattler assembly .....	-	2	2	-	-
7709	Shock absorber control connecting rod anti-rattler bracket screw No. 10-32 x 7/16" fill. head .....	-	12	12	-	-
5500	Lockwasher No. 10 .....	-	12	12	-	-
7003	Nut No. 10-32 .....	-	12	12	-	-
191829	Shock absorber control connecting rod bushing .....	10	-	-	-	-
194054	Shock absorber control connecting rod to cross member bracket and bushing assembly .....	2	-	-	-	-
7801	Screw 1/4-28 x 1/2" hex. hd. ....	2	-	-	-	-
7004	Nut 1/4-28 plain .....	2	-	-	-	-
5502	Lockwasher 1/4" plain .....	2	-	-	-	-
194045	Shock absorber control connecting rod and frame bracket and bushing assembly .....	2	-	-	-	-
7006	Screw No. 10-32 x 1/2" fill. head mach. ....	2	-	-	-	-
8206	Screw No. 10-32 x 1/2" flat head .....	2	-	-	-	-
5500	Lockwasher 3/18" .....	4	-	-	-	-
7003	Nut 3/16" plain .....	4	-	-	-	-
194046	Shock absorber control connecting rod to rear motor support bracket and bushing assembly .....	2	-	-	-	-
194053	Shock absorber control connecting rod to spring bracket-bracket and bushing assembly .....	2	-	-	-	-
7801	Screw 1/4-28 x 1/2" hex. hd. ....	2	-	-	-	-
5502	Lockwasher 1/4" .....	2	-	-	-	-
209762	Shock absorber control lever and bracket assembly .....	-	1	-	-	-
202435	Shock absorber control lever bracket and pin assembly ..	1	-	-	-	-
210279	Shock absorber control lever (After steering unit No. 900580) .....	1	-	-	-	-
202433	Shock absorber control lever (Prior to steering unit No. 900581) .....	1	-	-	-	-
209609	Shock absorber control lever .....	-	1	1	-	-
209717	Shock absorber control lever bracket .....	-	1	-	-	-
210490	Shock absorber control lever bracket .....	-	-	1	-	-
202434	Shock absorber control lever bracket .....	1	-	-	-	-
7800	Bolt 1/4-28 x 1" hex. hd. ....	2	-	-	-	-
8201	Bolt 1/4-28 x 5/8" countersunk hd. ....	-	2	2	-	-
5502	Lockwasher 1/4" .....	2	2	2	-	-
7004	Nut 1/4-28 plain .....	2	2	2	-	-
202432	Shock absorber control lever pin .....	1	-	-	-	-
3912	Washer 7/16" plain .....	1	-	-	-	-
209727	Shock absorber control lever shoulder screw .....	-	1	-	-	-
210513	Shock absorber control lever shoulder screw .....	-	-	1	-	-
209842	Shock absorber control lever shoulder screw .....	-	1	1	-	-
	Spring washer .....	-	1	1	-	-

Piece No.	Name	No. Required				
		905 906	1005 1006	1107 1108	1207 1208	1407 1408
207750	Shock absorber control lever spring washer (Supersedes 186436) .....	2	-	-	-	-
4290	Cotter pin 3/32 x 5/8" .....	1	-	-	-	-
201877	Shock absorber control operating rod assembly .....	1	-	-	-	-
209687	Shock absorber control operating rod assembly .....	-	1	1	-	-
190192	Spring washer 3/16" .....	-	1	-	-	-
215977	Yoke end pin .....	-	-	1	-	-
190045	Yoke end pin lock .....	-	-	1	-	-
7513	Yoke end 3/16" .....	-	1	1	-	-
7003	Nut No. 10-32 .....	-	1	1	-	-
7523	Yoke end pin 3/16" .....	-	1	-	-	-
195947	Shock absorber control operating rod bracket upper .....	1	1	1	-	-
7824	Screw 1/4-28 x 5/8" hex. hd. ....	2	2	2	-	-
5502	Lockwasher 1/4" .....	2	2	2	-	-
7004	Nut 1/4" .....	2	2	2	-	-
5470	Shock absorber control operating rod bracket lower screw 1/4-28 x 3/4" hex. hd. ....	2	2	2	-	-
5502	Lockwasher 1/4" .....	2	2	2	-	-
194536	Shock absorber control operating rod bushing .....	2	2	2	-	-
194008	Shock absorber control operating rod knob .....	1	1	1	-	-
194047	Shock absorber control operating rod knob lock nut .....	1	1	1	-	-
7524	Yoke end pin 1/4" .....	1	-	-	-	-
194732	Spring washer 1/4" .....	1	-	-	-	-
4280	Cotter pin 1/16 x 1/2" .....	1	-	-	-	-
5947	Yoke end 1/4" adj. ....	1	-	-	-	-
7004	Nut 1/4-28 .....	1	-	-	-	-
5035	Shock absorber control operating rod plunger ball .....	1	1	1	-	-
194528	Shock absorber control operating rod plunger guide .....	1	1	1	-	-
194597	Shock absorber control operating rod plunger spring .....	1	1	1	-	-
4291	Cotter pin 3/32 x 3/4" .....	1	1	1	-	-
195949	Shock absorber control operating rod support assembly ..	1	1	1	-	-
195948	Shock absorber control operating rod support tube and bracket assembly .....	1	1	1	-	-
191990	Shock absorber control rocker shaft .....	1	-	-	-	-
197921	Shock absorber control rocker shaft .....	-	1	1	-	-
194060	Shock absorber control rocker shaft bracket and bushing assembly-left .....	1	-	-	-	-
197924	Shock absorber control rocker shaft bracket and bushing assembly .....	-	2	2	-	-
194061	Shock absorber control rocker shaft bracket and bushing assembly-right .....	1	-	-	-	-
7827	Screw 1/4-28 x 3/4" hex. hd. ....	4	-	-	-	-
7824	Screw 1/4-28 x 5/8" hex. hd. ....	-	4	4	-	-
5502	Lockwasher 1/4" .....	4	4	4	-	-
7004	Nut 1/4-28 .....	4	4	4	-	-
191991	Shock absorber control rocker shaft bushing .....	2	-	-	-	-
197920	Shock absorber control rocker shaft bushing .....	-	2	2	-	-
191996	Shock absorber control rocker shaft lever .....	2	-	-	-	-
197926	Shock absorber control rocker shaft lever .....	-	2	2	-	-
4034	Taper pin .....	2	-	-	-	-
197927	Clamp screw .....	-	2	2	-	-
5500	Lockwasher No. 10 .....	-	2	2	-	-
7003	Nut No. 10-32 .....	-	2	2	-	-
101200	Washer .....	-	2	2	-	-
191994	Shock absorber control rocker shaft washer plain .....	2	-	-	-	-
3877	Shock absorber control rocker shaft washer plain .....	-	2	2	-	-
191995	Shock absorber control rocker shaft washer spring .....	1	-	-	-	-
190191	Shock absorber control rocker shaft washer spring .....	-	1	1	-	-
4290	Cotter pin 3/32 x 5/8" .....	-	1	1	-	-
4305	Cotter pin 1/8 x 7/8" .....	1	-	-	-	-

SERVICE PARTS LIST—PACKARD TWELVE

Shock Absorber 161

Piece No.	Name	No. Required				
		905 906	1005 1006	1107 1108	1207 1208	1407 1408
205694	Shock absorber control valve and lever assembly-right front	1	-	-	-	-
205695	Shock absorber control valve and lever assembly-left front	1	-	-	-	-
205696	Shock absorber control valve and lever assembly-right rear	1	-	-	-	-
205697	Shock absorber control valve and lever assembly-left rear	1	-	-	-	-
5849	Shock absorber to frame bolt-front	4	-	-	-	-
6301	Shock absorber to frame bolt-front 9/16-18 x 4" hex. hd.	-	4	4	-	-
6250	Shock absorber to frame bolt-rear 9/16-18 x 3-1/2" spec.	-	4	4	-	-
5842	Shock absorber to frame bolt-rear	4	-	-	-	-
7009	Nut 9/16-18	4	4	4	-	-
5512	Lockwasher 9/16"	8	8	8	-	-
8214	Screw 1/4-28 x 3/4" flat head	2	-	-	-	-
7852	Screw 1/4-28 x 7/8" hex. hd.	-	2	2	-	-
5502	Lockwasher 1/4"	2	2	2	-	-
7004	Nut 1/4-28 plain	2	2	2	-	-
184308	Shock absorber front axle bracket	2	-	-	-	-
209336	Shock absorber front axle bracket	-	2	2	-	-
139508	Shock absorber front axle bracket screw	-	4	4	-	-
5282	Shock absorber front axle bracket screw	4	-	-	-	-
5508	Lockwasher 7/16"	4	4	4	-	-
7007	Nut 7/16-20 plain	4	-	-	-	-
185188	Shock absorber housing oil plug	4	-	-	-	-
185189	Shock absorber housing oil plug gasket	4	-	-	-	-
98651	Shock absorber link assembly-front	2	-	-	-	-
98653	Shock absorber link assembly-front	-	2	2	-	-
98652	Shock absorber link assembly-rear	2	2	2	-	-
7008	Shock absorber link ball nut	8	8	8	-	-
5510	Shock absorber link ball lockwasher	8	8	8	-	-
98656	Shock absorber link grommet-upper	8	8	8	-	-
98657	Shock absorber link grommet-lower	8	8	8	-	-
98655	Shock absorber link grommet retainer	16	16	16	-	-
98654	Shock absorber link rod anchor	8	8	8	-	-
7007	Shock absorber link rod nut	8	8	8	-	-
185176	Shock absorber piston	4	-	-	-	-
185174	Shock absorber piston cylinder nut	4	-	-	-	-
185175	Shock absorber piston cylinder nut gasket	4	-	-	-	-
185177	Shock absorber piston intake valve	4	-	-	-	-
185178	Shock absorber piston intake valve spring	4	-	-	-	-
185179	Shock absorber piston link	4	-	-	-	-
185181	Shock absorber piston link pin	4	-	-	-	-
185180	Shock absorber piston link spring	4	-	-	-	-
185186	Shock absorber relief valve gasket	8	-	-	-	-
185185	Shock absorber relief valve nut	8	-	-	-	-
205912	Shock absorber relief valve plug gasket	8	-	-	-	-
209007	Shock absorber rear right shield assembly	-	1	1	-	-
7706	Screw No. 10-32 x 1/2" fill. hd.	-	4	4	-	-
7703	Nut No. 10-32	-	4	4	-	-
5500	Lockwasher No. 10	-	4	4	-	-
213301	Shock absorber metering valve and lever assembly-front No. 58 (.042)	-	2	2	-	-
216994	Shock absorber metering valve and lever assembly-right No. 58 (.042)	-	1	1	-	-
216996	Shock absorber metering valve and lever assembly-left No. 58 (.042)	-	1	1	-	-
213898	Shock absorber metering valve and lever assembly-rear No. 64 (.042)	-	2	2	-	-
213900	Shock absorber metering valve and lever assembly-rear No. 72 (.025)	-	2	2	-	-
216998	Shock absorber metering valve and lever assembly-rear right No. 64 (.036)	-	1	1	-	-
216983	Shock absorber metering valve and lever assembly-rear left No. 64 (.036)	-	1	1	-	-
213899	Shock absorber side plate gasket	-	4	4	-	-

Piece No.	Name	No. Required				
		985 906	1005 1006	1107 1108	1207 1208	1407 1408
<b>SHOCK ABSORBER</b>						
223703	Shock absorber assembly-front left (rear carrier) .....	-	-	-	1	-
223703	Shock absorber assembly-front left (rear carrier) (Used on bodies 932-33-34-35-36-37-38) .....	-	-	-	-	1
223702	Shock absorber assembly-front right (rear carrier) .....	-	-	-	1	-
223702	Shock absorber assembly-front right (rear carrier) (Used on bodies 932-33-34-35-36-37-38) .....	-	-	-	-	1
225951	Shock absorber assembly-front left (side carrier) .....	-	-	-	1	-
225951	Shock absorber assembly-front left (side carrier) (Used on bodies 932-33-34-35-36-37-38) .....	-	-	-	-	1
225952	Shock absorber assembly-front right (side carrier) .....	-	-	-	1	-
225952	Shock absorber assembly-front right (side carrier) (Used on bodies 932-33-34-35-36-37-38) .....	-	-	-	-	1
230394	Shock absorber assembly-front left (Used on bodies 921-31-39-L295) .....	-	-	-	-	1
230395	Shock absorber assembly-front right (Used on bodies 921-31-39-L295) .....	-	-	-	-	1
230494	Shock absorber assembly-front left (Used on body L294) ..	-	-	-	-	1
230495	Shock absorber assembly-front right (Used on body L294) ..	-	-	-	-	1
231024	Shock absorber assembly-front left (Used on bodies 927-30-73) .....	-	-	-	-	1
231025	Shock absorber assembly-front right (Used on bodies 927-30-73) .....	-	-	-	-	1
223696	Shock absorber assembly-rear right (rear carrier) .....	-	-	-	1	-
225953	Shock absorber assembly-rear right (side carrier) .....	-	-	-	1	-
223697	Shock absorber assembly-rear left (rear carrier) .....	-	-	-	1	-
225954	Shock absorber assembly-rear left (side carrier) .....	-	-	-	1	-
223696	Shock absorber assembly-rear right (rear carrier) (Used on bodies 932-33-34-35-36-37-38) .....	-	-	-	-	1
225953	Shock absorber assembly-rear right (side carrier) (Used on bodies 932-33-34-35-36-37-38) .....	-	-	-	-	1
223697	Shock absorber assembly-rear left (rear carrier) (Used on bodies 932-33-34-35-36-37-38) .....	-	-	-	-	1
225954	Shock absorber assembly-rear left (side carrier) (Used on bodies 932-33-34-35-36-37-38) .....	-	-	-	-	1
225953	Shock absorber assembly-rear right (Used on bodies 921-27-30-31-39-973-L295) .....	-	-	-	-	1
225954	Shock absorber assembly-rear left (Used on bodies 921-27-30-31-39-973-L295) .....	-	-	-	-	1
230496	Shock absorber assembly-rear left (Used on body L294) ..	-	-	-	-	1
230497	Shock absorber assembly-rear right (Used on body L294) ..	-	-	-	-	1
223861	Shock absorber control connecting rod-front left .....	-	-	-	1	1
223863	Shock absorber control connecting rod-front right .....	-	-	-	1	1
223870	Shock absorber control connecting rod (intermediate left) .....	-	-	-	1	1
223871	Shock absorber control connecting rod (intermediate right) .....	-	-	-	1	1
223622	Shock absorber control connecting rod (intermediate lever) .....	-	-	-	1	1
223617	Shock absorber control connecting rod intermediate lever shoulder screw .....	-	-	-	1	1
190191	Spring washer .....	-	-	-	1	1
7004	Nut 1/4-28 .....	-	-	-	1	1
5502	Lockwasher 1/4" .....	-	-	-	1	1
223673	Shock absorber control connecting rod (rear) (Used on 1207-1407) .....	-	-	-	2	2
223874	Shock absorber control connecting rod (rear) (Used on 1208-1408) .....	-	-	-	2	2
223936	Shock absorber control connecting rod front anti-rattler bracket-right assembly .....	-	-	-	1	1
223937	Shock absorber control connecting rod-intermediate anti-rattler bracket assembly .....	-	-	-	2	2
223936	Shock absorber control connecting rod-intermediate anti-rattler bracket-front assembly .....	-	-	-	1	1
223935	Shock absorber control connecting rod anti-rattler bracket front left and right assembly (Used on 1208- 1408) .....	-	-	-	2	2

## SERVICE PARTS LIST—PACKARD TWELVE

Shock Absorber 163

Piece No	Name	No. Required				
		905 906	1005 1006	1107 1108	1207 1208	1407 1408
223934	Shock absorber control connecting rod rear anti-rattler bracket right assembly (Used on 1207-1407) .....	-	-	-	1	1
223934	Shock absorber control connecting rod rear anti-rattler bracket left assembly (Used on 1207-1407) .....	-	-	-	1	1
223934	Shock absorber control connecting rod rear anti-rattler bracket rear right and left assembly (Used on 1208-1408) .....	-	-	-	2	2
7709	Screw No. 10-32 x 7/16" fill. hd. ....	-	-	-	12	8
7003	Nut No. 10-32 .....	-	-	-	12	8
5500	Lockwasher No. 10 .....	-	-	-	12	8
114775	Shock absorber control connecting rod (front) ball joint .....	-	-	-	1	1
7003	Ball joint nut No. 10-32 .....	-	-	-	2	2
5500	Lockwasher 3/16" .....	-	-	-	2	2
7513	Yoke end adjusting .....	-	-	-	11	-
230143	Yoke end adjusting .....	-	-	-	-	11
7003	Nut No. 10-32 .....	-	-	-	11	11
230142	Nut special .....	-	-	-	-	11
5500	Lockwasher 3/16" .....	-	-	-	11	-
215977	Yoke end pin .....	-	-	-	11	-
230313	Yoke end pin .....	-	-	-	-	11
190192	Spring washer 3/16" .....	-	-	-	11	x
190045	Yoke end pin lock .....	-	-	-	11	11
223830	Shock absorber control lever .....	-	-	-	1	1
223620	Shock absorber control lever support .....	-	-	-	1	1
7005	Nut 5/16-24 .....	-	-	-	1	1
5504	Lockwasher 5/16" .....	-	-	-	1	1
190191	Shock absorber control lever support spring washer .....	-	-	-	1	1
3911	Washer (plain) 3/8" .....	-	-	-	1	1
223616	Shock absorber control lever support retaining ring .....	-	-	-	1	1
228901	Shock absorber control operating rod assembly (Supersedes 223834) .....	-	-	-	1	1
7513	Shock absorber control operating rod yoke end 3/16" adj. ....	-	-	-	1	-
230143	Shock absorber control operating rod yoke end .....	-	-	-	-	1
5500	Lockwasher 3/16" .....	-	-	-	1	1
215977	Shock absorber control operating rod yoke end pin .....	-	-	-	1	-
230313	Shock absorber control operating rod yoke end pin .....	-	-	-	-	1
190045	Shock absorber control operating rod yoke end pin lock .....	-	-	-	1	1
190192	Shock absorber control operating rod yoke end pin spring-washer .....	-	-	-	1	x
7003	Nut No. 10-32 .....	-	-	-	1	1
223624	Shock absorber control operating rod bracket-upper .....	-	-	-	1	1
5667	Screw No. 10-32 x 5/8" round hd. ....	-	-	-	2	2
5500	Lockwasher No. 10 .....	-	-	-	2	2
5315	Screw 1/4-28 x 1-3/8" hex. hd. (lower) .....	-	-	-	2	2
5502	Lockwasher 1/4" .....	-	-	-	2	2
194536	Shock absorber control operating rod bushing .....	-	-	-	2	2
194008	Shock absorber control operating rod knob .....	-	-	-	1	1
194047	Shock absorber control operating rod knob lock nut .....	-	-	-	1	1
5035	Shock absorber control operating rod plunger ball 7/16" .....	-	-	-	1	1
194528	Shock absorber control operating rod plunger guide .....	-	-	-	1	1
194597	Shock absorber control operating rod plunger spring .....	-	-	-	1	1
4291	Cotter pin 3/32 x 3/4" .....	-	-	-	1	1
223626	Shock absorber control operating rod support assembly .....	-	-	-	1	1
223625	Shock absorber control operating rod support tube and bracket assembly .....	-	-	-	1	1
223909	Shock absorber control rocker shaft (Prior to frame No. 903390) .....	-	-	-	1	-
225447	Shock absorber control rocker shaft (After frame No. 903389) .....	-	-	-	1	1



Piece No.	Name	No. Required				
		905 906	1005 1006	1107 1108	1207 1208	1407 1408
197924	Shock absorber control rocker shaft bracket and bushing assembly (Prior to frame No. 903390) .....	-	-	-	2	-
225448	Shock absorber control rocker shaft bracket and bushing assembly (After frame No. 903389) .....	-	-	-	2	2
7824	Screw 1/4-28 x 5/8" hex. hd. ....	-	-	-	4	4
5502	Lockwasher 1/4" .....	-	-	-	4	4
7004	Nut 1/4-28 .....	-	-	-	4	4
197920	Shock absorber control rocker shaft bushing (Prior to frame No. 903390) .....	-	-	-	2	-
225445	Shock absorber control rocker shaft bushing (After frame No. 903389) .....	-	-	-	2	2
4290	Cotter pin 3/32 x 5/8" (Prior to frame No. 903390) ..	-	-	-	1	-
4291	Cotter pin 3/32 x 3/4" (After frame No. 903389) ....	-	-	-	1	1
223621	Shock absorber control rocker shaft lever (Prior to frame No. 903390) .....	-	-	-	2	-
225449	Shock absorber control rocker shaft lever (After frame No. 903389) .....	-	-	-	2	2
197927	Clamp screw (Prior to frame No. 903390) .....	-	-	-	2	-
5500	Lockwasher No. 10 (Prior to frame No. 903390) .....	-	-	-	2	-
7003	Nut No. 10-32 (Prior to frame No. 903390) .....	-	-	-	2	-
101200	washer (Prior to frame No. 903390) .....	-	-	-	2	-
300181	Shock absorber control rocker shaft lever pin (After frame No. 903389) .....	-	-	-	2	2
3877	Shock absorber control rocker shaft washer 3/8" (Prior to frame No. 903390) .....	-	-	-	2	-
3884	Shock absorber control rocker shaft washer 1/2" (After frame No. 903389) .....	-	-	-	3	3
190191	Shock absorber control rocker shaft spring-washer (Prior to frame No. 903390) .....	-	-	-	1	-
202056	Shock absorber control rocker shaft spring washer (After frame No. 903389) .....	-	-	-	1	1
5849	Shock absorber front to bracket bolt (9/16-18 x 3-1/2" hex. hd.) .....	-	-	-	4	4
5512	Lockwasher 9/16" .....	-	-	-	4	-
6250	Shock absorber rear to frame bolt (9/16-18 x 3-1/2" special) .....	-	-	-	4	4
7009	Nut 9/16-18 .....	-	-	-	4	4
5512	Lockwasher 9/16" .....	-	-	-	4	4
223277	Shock absorber front axle bracket .....	-	-	-	2	2
139508	Shock absorber front axle bracket screw 7/16-20 x 2-3/4 hex. hd. ....	-	-	-	4	4
5508	Lockwasher 7/16" .....	-	-	-	4	4
223148	Shock absorber front link assembly .....	-	-	-	2	2
221724	Shock absorber rear link assembly .....	-	-	-	2	2
98680	Shock absorber link bushing assembly .....	-	-	-	4	4
221726	Shock absorber link clevis bolt .....	-	-	-	4	4
5261	Nut 3/8" .....	-	-	-	4	4
5506	Lockwasher 3/8" .....	-	-	-	4	4
223018	Shock absorber link clevis bolt bushing .....	-	-	-	4	4
223019	Shock absorber link clevis bolt grommet .....	-	-	-	4	4
223020	Shock absorber link clevis bolt sleeve .....	-	-	-	4	4
221725	Shock absorber link grommet .....	-	-	-	8	8
221721	Shock absorber link grommet retainer .....	-	-	-	8	8
7008	Nut 1/2-20 .....	-	-	-	4	4
4291	Cotter pin 3/32 x 3/4" .....	-	-	-	4	4
209007	Shock absorber (rear right) shield assembly .....	-	-	-	1	1
7706	Screw No. 10-32 x 1/2" fill. hd. ....	-	-	-	4	4
7003	Nut No. 10-32 .....	-	-	-	4	4
5500	Lockwasher No. 10 .....	-	-	-	4	4

Piece No.	Name	No. Required				
		905 906	1005 1006	1107 1108	1207 1208	1407 1408
<b>SHOCK ABSORBER RELIEF VALVE</b>						
230398	Shock absorber valve-rebound-front (No. 3-CH) .....	-	-	-	-	2
213164	Shock absorber valve-rebound-front (No. 1-CH) .....	2	2	2	-	-
225905	Shock absorber valve-rebound-front (No. 2-CH) .....	-	-	-	2	2
225649	Shock absorber valve-rebound-rear (No. 5-HT) .....	-	-	-	2	2
213179	Shock absorber valve-rebound-rear (No. 5-GR) .....	2	2	2	2	2
230399	Shock absorber valve-rebound-rear (No. 5-J) .....	-	-	-	-	2
203814	Shock absorber valve-compression-front (No. G-4) .....	2	2	2	-	-
225700	Shock absorber valve-compression-front (No. E-4) .....	-	-	-	2	2
225673	Shock absorber valve-compression-front (No. E-3) .....	-	-	-	2	2
230459	Shock absorber valve-compression-front (No. E-2) .....	-	-	-	-	2
203812	Shock absorber valve-compression-rear (No. G-1) .....	-	-	-	2	2
203811	Shock absorber valve-compression-rear (No. G-2) .....	2	2	2	-	-
231029	Shock absorber valve-compression-rear (No. L-1) .....	-	-	-	-	2
209655	Shock absorber valve-static (2-7) .....	-	4	4	-	-
209655	Shock absorber valve-static-front (2-7) .....	-	-	-	2	2
225702	Shock absorber valve-static-rear (1-7) .....	-	-	-	2	2

Piece No	Name	No. Required							
		901 906	1005 1006	1107 1108	1207 1208	1407 1408			
<b>SHOCK ABSORBER AND SPRING CHART</b>									
CHASSIS MODEL	BODY MODEL	FRONT OR REAR	SPRINGS ASB. NO.	SHOCK ABSORBERS		VALVE DATA			
				LEFT	RIGHT	REBOUND	COMPR.	STATIC	
1407 Std.	932 933 936	Front Rear	221786 180396	223703 223697	223702 223696	2-CH 5-GR	E-4 G-1	2-7+ 1-7+	
1407 DeLuxe	932 933 936	Front Rear	221786 180396	225951 225954	225952 225953	2-CH 5-HT	E-3 G-1	2-7+ 1-7+	
1407 Std.	937	Front Rear	221786 180394	223703 223697	223702 223696	2-CH 5-GR	E-4 G-1	2-7+ 1-7+	
1407 DeLuxe	938	Front Rear	221786 180386	225951 225954	225952 225953	2-CH 5-HT	E-3 G-1	2-7+ 1-7+	
1407 DeLuxe	937	Front Rear	221786 180394	225951 223697	225952 223696	2-CH 5-GR	E-3 G-1	2-7+ 0-7+	
1407 Std.	938	Front Rear	221786 180386	223703 223697	223702 223696	2-CH 5-GR	E-4 G-1	2-7+ 1-7+	
1407	939	Front Rear	230348 180394	230394 225954	230395 225953	3-CH 5-HT	E-3 G-1	2-7+ 1-7+	
1407	921 931	Front Rear	230348 180394	230394 225954	230395 225953	3-CH 5-HT	E-3 G-1	2-7+ 1-7+	
1407	927	Front Rear	230348 180396	231024 225954	231025 225953	3-CH 5-HT	E-2 G-1	2-7+ 1-7+	
1407	L-294	Front Rear	230348 180398	230494 230496	230495 230497	3-CH 5-J	E-3 L-1	2-7+ 1-7+	
1408 Std.	934 935	Front Rear	221786 180398	223703 223697	223702 223696	2-CH 5-GR	E-4 G-1	2-7+ 1-7+	
1408 DeLuxe	934 935	Front Rear	221786 180398	225951 225954	225952 225953	2-CH 5-HT	E-3 G-1	2-7+ 1-7+	
1408	973	Front Rear	230348 180396	230394 225954	230395 225953	3-CH 5-HT	E-3 G-1	2-7+ 1-7+	
1408 DeLuxe	930	Front Rear	230348 180396	225951 225954	225952 225953	2-CH 5-HT	E-3 G-1	2-7+ 1-7+	
1408	L-295	Front Rear	230348 180398	230394 225954	230395 225953	3-CH 5-HT	E-3 G-1	2-7+ 1-7+	
1408 Std.	930	Front Rear	230348 180396	223703 223697	223702 223696	2-CH 5-GR	E-4 G-1	...+ 1-7+	

Piece No.	Name	No. Required				
		903 906	1005 1006	1107 1108	1207 1208	1407 1408

### SHOCK ABSORBER

The following parts are listed with the manufacturers' piece numbers and are to be ordered by these numbers. Dealers should order these parts through their distributor.

Piece No.	Name	ILLUS. No.	903 906	1005 1006	1107 1108	1207 1208	1407 1408
D-46137	Body front right .....	1	-	1	1	-	-
D-46136	Body front left .....	1	-	1	1	-	-
D-46139	Body rear left .....	1	-	1	1	-	-
D-46138	Body rear right .....	1	-	1	1	-	-
D-106077B	Arm front .....	2	-	2	2	-	-
D-1060726	Arm rear left .....	2	-	1	1	-	-
D-1060723	Arm rear right .....	2	-	1	1	-	-
D-44559	Piston .....	4	-	4	4	-	-
D-43226	Cam .....	6	-	X	X	-	-
D-43836	Cam bushing .....	7	-	X	X	-	-
D-43221	Intake valve .....	8	-	X	X	-	-
D-43222	Intake valve spring .....	9	-	X	X	-	-
D-39921	Intake valve assembly .....	10	-	X	X	-	-
D-114861	Intake valve ball .....	11	-	X	X	-	-

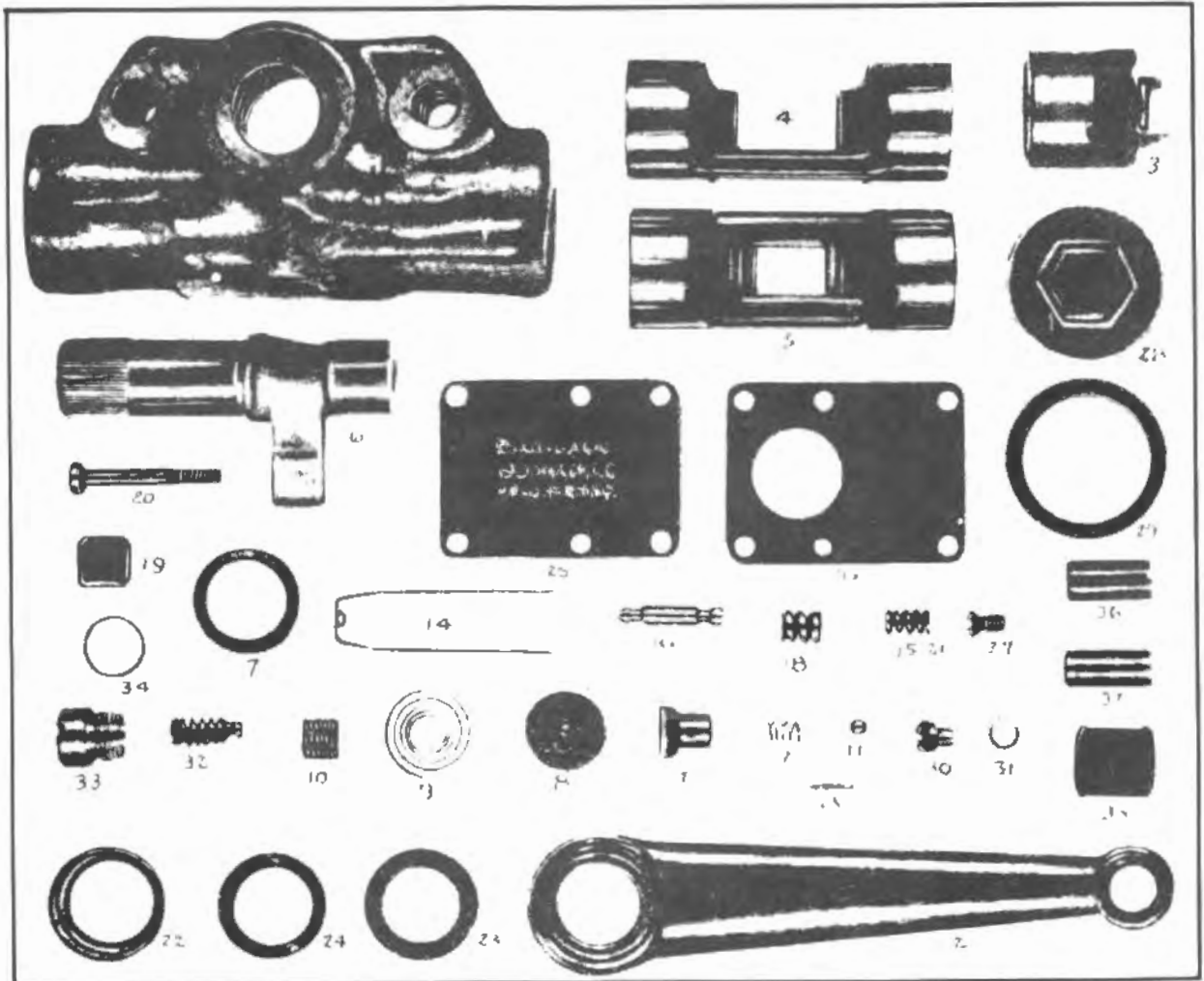

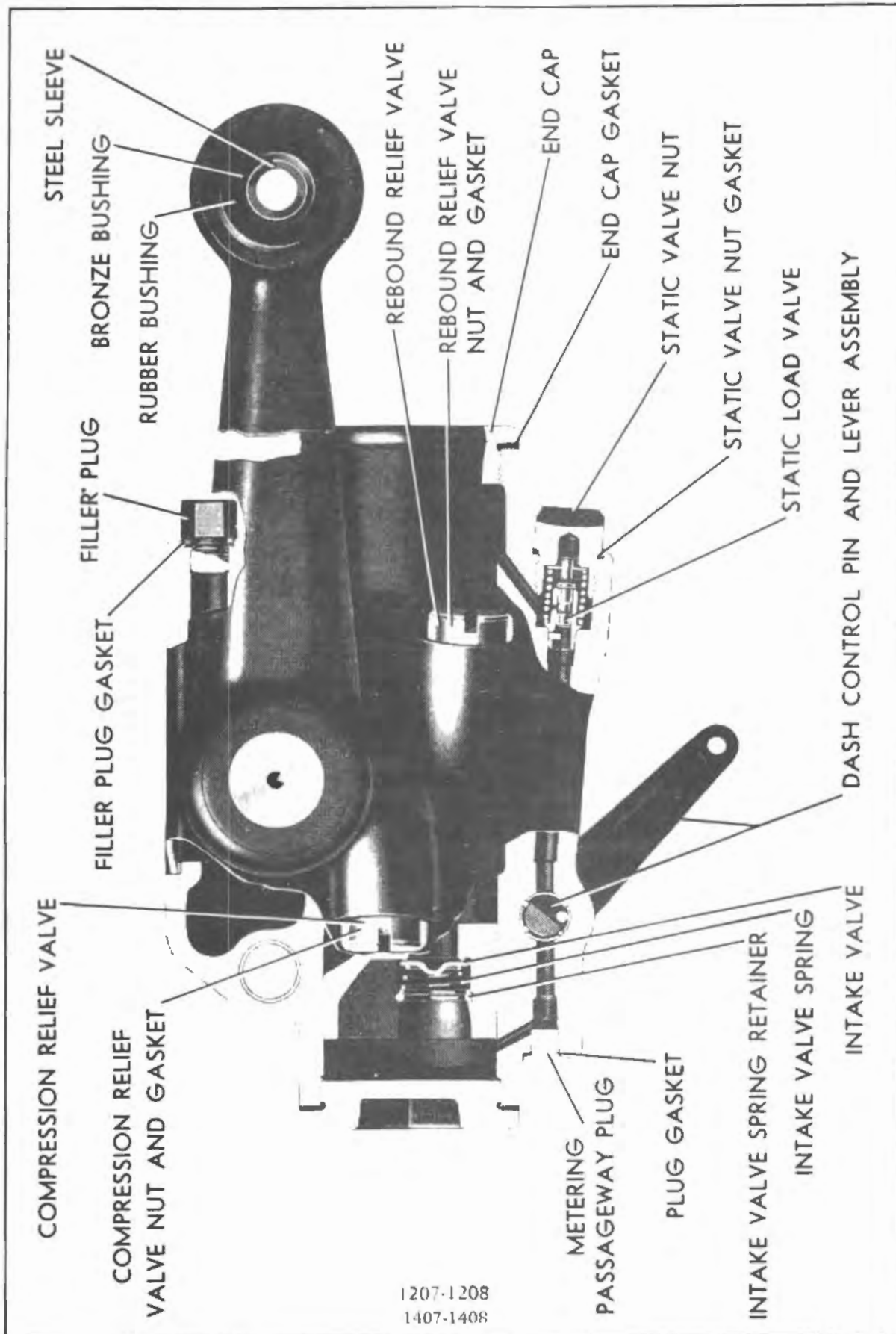

Piece No.	Name	No. Required					
		905 906	1005 1006	1107 1108	1207 1208	1407 1408	
D-44667	Intake valve ball spring .....	12	-	X	X	-	-
D-44668	Intake valve retainer pin .....	13	-	X	X	-	-
D-43223	Piston link .....	14	-	X	X	-	-
D-43224	Piston link spring .....	15	-	X	X	-	-
D-43225	Piston link pin .....	16	-	X	X	-	-
D-44069	Piston-cam bearing button .....	17	-	X	X	-	-
D-43995	Piston-cam tension spring .....	18	-	X	X	-	-
D-43220	Cam bearing button .....	19	-	X	X	-	-
D-44564	Piston connecting screw .....	20	-	X	X	-	-
D-44565	Piston connecting screw spring .....	21	-	X	X	-	-
D-43228	Packing gland .....	22	-	X	X	-	-
D-821059	Packing washer-cork .....	23	-	X	X	-	-
D-43230	Packing washer-rubber .....	24	-	X	X	-	-
D-43231	Cover plate .....	25	-	X	X	-	-
D-43232	Cover plate gasket .....	26	-	X	X	-	-
D-43278	Cover plate screw .....	27	-	X	X	-	-
D-43215	Piston cylinder nut .....	28	-	X	X	-	-
D-43216	Piston cylinder nut gasket .....	29	-	X	X	-	-
D-827620	Oil plug screw .....	30	-	X	X	-	-
D-827799	Oil plug screw gasket .....	31	-	X	X	-	-
	Relief valve assembly (See Packard No.).	32	-	X	X	-	-
D-43233	Relief valve nut .....	33	-	X	X	-	-
D-43234	Relief valve gasket .....	34	-	X	X	-	-

SHOCK ABSORBER

The following parts are listed with the manufacturers' piece numbers and are to be ordered by these numbers. Dealers should order these parts through their distributor.

D-828629	Dash control valve and lever gasket .....	-	-	-	-	X	X
D-43233	Relief valve nut .....	-	-	-	-	X	X
D-43234	Relief valve nut gasket .....	-	-	-	-	X	X
D-41229	Intake valve only .....	-	-	-	-	X	X
D-46811	Intake valve spring .....	-	-	-	-	X	X
D-46812	Intake valve retainer .....	-	-	-	-	X	X
D-43215	End cap .....	-	-	-	-	X	X
D-46464	End cap steel spacer .....	-	-	-	-	X	X
D-44933	End cap gasket .....	-	-	-	-	X	X
D-45275	Filler plug .....	-	-	-	-	X	X
D-45278	Filler plug gasket .....	-	-	-	-	X	X
D-42548	Static valve nut .....	-	-	-	-	X	X
D-828629	Static valve nut gasket .....	-	-	-	-	X	X
D-46146	Metering passageway plug .....	-	-	-	-	X	X
D-827799	Metering passageway plug gasket .....	-	-	-	-	X	X
D-49975	Rubber bushing (link end of arm) .....	-	-	-	-	X	X
D-49976	Bronze bushing (link end of arm) .....	-	-	-	-	X	X
D-49977	Steel sleeve (link end of arm) .....	-	-	-	-	X	X

SPLASHER

202629	Splasher frame to crankcase front .....	1	1	1	-	-	-
5786	Screw 1/4-28 x 3/4" hex. hd. ....	3	4	4	-	-	-
7824	Screw 1/4-28 x 5/8" hex. hd. ....	2	4	4	-	-	-
5852	Screw 1/4-28 x 1-7/8" hex. hd. ....	-	-	1	-	-	-
3868	Washer 1/4" plain .....	7	12	12	-	-	-

Piece No.	Name	No. Required				
		905 906	1005 1006	1107 1108	1207 1208	1407 1408
7004	Nut 1/4-28 plain .....	5	8	8	-	-
5502	Lockwasher 1/4" .....	5	8	8	-	-
203105	Splasher frame to crankcase and reinforcement assembly left .....	1	-	-	-	-
203106	Splasher frame to crankcase and reinforcement assembly right .....	1	-	-	-	-
203688	Splasher frame to crankcase left assembly .....	-	1	1	-	-
203581	Splasher frame to crankcase right assembly .....	-	1	1	-	-
62065	Washer 1/4" special .....	-	10	10	-	-
7824	Screw 1/4-28 x 5/8" hex. hd. ....	12	10	-	-	-
7827	Screw 1/4-28 x 3/4" hex. hd. ....	-	-	9	-	-
3868	Washer 1/4" plain .....	12	-	-	-	-
5502	Lockwasher 1/4" .....	12	10	10	-	-
7004	Nut 1/4-28 plain .....	12	10	10	-	-
191961	Splasher frame to crankcase left spring bracket cutout cover .....	1	1	1	-	-
7824	Screw 1/4-28 x 5/8" hex. hd. ....	3	2	3	-	-
7827	Screw 1/4-28 x 3/4" hex. hd. ....	-	1	1	-	-
3868	Washer 1/4" plain .....	3	3	3	-	-
5502	Lockwasher 1/4" .....	3	3	3	-	-
7004	Nut 1/4-28 plain .....	3	3	3	-	-
207884	Splasher frame to crankcase brace left .....	-	1	1	-	-
209083	Splasher frame to crankcase brace right .....	-	1	1	-	-
7824	Screw 1/4-28 x 5/8" hex. hd. ....	-	3	3	-	-
7004	Nut 1/4-28 .....	-	3	3	-	-
5502	Lockwasher 1/4" .....	-	3	3	-	-
3868	Washer .....	-	3	3	-	-
136982	Splasher frame to crankcase brace left spacer .....	-	1	1	-	-
183068	Splasher frame to crankcase left oil gauge wire grommet.	-	1	-	-	-
215992	Splasher frame to crankcase front liner-front .....	-	-	1	-	-
215991	Splasher frame to crankcase front liner-side .....	-	-	2	-	-
215999	Splasher frame to crankcase right and left side liner- front .....	-	-	2	-	-
216111	Splasher frame to crankcase right and left side liner- rear .....	-	-	2	-	-
191209	Splasher frame rear end assembly (Single carrier) .....	1	-	-	-	-
191636	Splasher frame rear end assembly (Double rear carrier) (Used on body models No. 570-1-3-4-5-7-8-9-581-3) ....	1	-	-	-	-
194162	Splasher frame rear end assembly (Double rear carrier) (Used on body models No. 576-587) .....	1	-	-	-	-
191634	Splasher frame rear end assembly (Side wheel carrier) (Used on body models No. 570-1-3-4-5-6-7-8-9-581-583).	1	-	-	-	-
194167	Splasher frame rear end assembly (Side wheel carrier) (Used on body models No. 576-587) .....	1	-	-	-	-
205711	Splasher frame rear end assembly (Single carrier) .....	-	1	-	-	-
205712	Splasher frame rear end assembly (Side wheel carrier) (Not used on body 636) .....	-	1	-	-	-
205719	Splasher frame rear end assembly (Side wheel carrier) ..	-	1	-	-	-
215621	Splasher frame rear end assembly (Used on 736-747) .....	-	-	1	-	-
215620	Splasher frame rear end assembly (Not used on body 736- 747) .....	-	-	1	-	-
215622	Splasher frame rear end assembly (Used on 736-747) (Side wheel carrier) .....	-	-	1	-	-
215623	Splasher frame rear end assembly (Used on 731-2-3-8-9- 41-43-D858-D859) (Side wheel carrier) .....	-	-	1	-	-
215624	Splasher frame rear end assembly (Used on 730-4-5-7) (Side wheel carrier) .....	-	-	1	-	-
184994	Splasher frame rear end clamp .....	1	1	1	-	-
5868	Screw No. 10-32 x 5/8" F.H. ....	2	2	2	-	-



SERVICE PARTS LIST—PACKARD TWELVE

Splasher 171

Piece No.	Name	No. Required				
		905 906	1005 1006	1107 1108	1207 1208	1407 1408
5491	Lockwasher 3/16" countersunk .....	2	2	2	-	-
39403	Splasher frame rear end clamp liner 3/4" wide x 5" long.	1	1	1	-	-
191215	Splasher frame rear end bar (Body models No. 570-4-5) ..	2	-	-	-	-
191268	Splasher frame rear end bar (Body models No. 571-3-7-8-9-581) .....	2	-	-	-	-
191269	Splasher frame rear end bar (Body models No. 576 for 905) .....	2	2	2	-	-
5447	Lockwasher 1/4" .....	8	8	8	-	-
191858	Screw 1/4-20 x 3/8" hex. hd. (Not used on 636-736) .	8	8	8	-	-
190246	Splasher frame rear end bolt hole cover (Plug 1-5/8" dia. hole) .....	2	2	2	-	-
205824	Splasher frame rear end bar hole screw (Body model 576).	2	-	-	-	-
197621	Splasher frame rear end bar hole screw cup washer (Body model 576) .....	2	-	-	-	-
5502	Lockwasher 1/4" (Body model 576) .....	2	-	-	-	-
7004	Nut 1/4-28 (Body model 576) .....	2	-	-	-	-
194143	Splasher frame rear end to cross channel spacer liner (Double rear carrier) .....	4	-	-	-	-
191327	Splasher frame rear end liner .....	4	4	-	-	-
215846	Splasher frame rear end liner .....	-	-	4	-	-
194720	Splasher frame rear end wheel carrier bracket brace shroud assembly (Single rear carrier) (Not used on 636-736-747) .....	1	1	1	-	-
194720	Splasher frame rear end wheel carrier bracket brace shroud assembly (Double rear carrier) .....	2	-	-	-	-
5771	Screw No. 10-32 x 3/8" round head (Single rear carrier) .....	2	2	2	-	-
5771	Screw No. 10-32 x 3/8" round head (Double rear carrier) .....	4	-	-	-	-
5500	Lockwasher No. 10 (Single rear carrier) .....	2	2	2	-	-
5500	Lockwasher No. 10 (Double rear carrier) .....	4	-	-	-	-
194719	Splasher frame rear end wheel carrier bracket brace shroud hole cover assembly (Used on body models 576-587-636-647) (Double rear carrier and side carrier) ..	1	1	-	-	-
5771	Screw No. 10-32 x 3/8" round head (Used on body models No. 576-587-636-647) (Double rear carrier and side carrier) .....	2	2	-	-	-
5500	Lockwasher No. 10 (Used on body models No. 576-587-636-647) (Double rear carrier and side carrier) ..	2	2	-	-	-
201155	Splasher-front left assembly .....	1	-	-	-	-
205879	Splasher-front left assembly .....	-	1	1	-	-
201156	Splasher-front right assembly .....	1	-	-	-	-
205878	Splasher-front right assembly .....	-	1	1	-	-
194699	Splasher-front bolt front spacer .....	2	2	2	-	-
5971	Splasher-front bolt front screw 1/4-28 x 2" .....	2	2	2	-	-
3868	Splasher-front bolt front washer 1/4" plain .....	2	2	2	-	-
5502	Lockwasher .....	2	2	2	-	-
201152	Splasher-front to frame front channel support bracket ..	1	-	-	-	-
210049	Splasher-front to frame front channel support bracket assembly .....	-	1	1	-	-
5317	Screw 1/4-28 x 1-1/8" hex. hd. .....	2	2	-	-	-
7827	Screw 1/4-28 x 3/4" hex. hd. .....	-	-	2	-	-
7824	Screw 1/4-28 x 5/8" hex. hd. .....	1	1	1	-	-
5502	Lockwasher 1/4" .....	3	3	3	-	-
7004	Nut 1/4-28 plain .....	3	3	3	-	-
203894	Splasher-front to frame front channel support bracket spacer .....	2	-	-	-	-
191267	Splasher-front to frame front cross tube grommet-left ..	1	-	-	-	-
191266	Splasher-front to frame front cross tube grommet-right .	1	-	-	-	-
210434	Splasher-front to frame front end cross tube grommet-upper half .....	-	2	2	-	-

Piece No.	Name	No. Required				
		905 906	1005 1006	1107 1108	1207 1208	1407 1408
210435	Splasher-front to frame front end cross tube grommet- lower half .....	-	2	2	-	-
6340	Screw No. 10-24 x 3/4" fill. hd. ....	-	4	4	-	-
5500	Lockwasher No. 10 .....	-	4	4	-	-
210816	Splasher-front liner .....	-	1	1	-	-
209482	Splasher-front hold down plate liner .....	-	2	2	-	-
182324	Splasher-front to radiator shell bumper .....	-	8	8	-	-
190930	Splasher-side left assembly (Used on 906 only) .....	1	-	-	-	-
191604	Splasher-side left assembly (Side wheel carrier) (Used on 906 only) .....	1	-	-	-	-
190934	Splasher-side left assembly (Used on 905 only) .....	1	-	-	-	-
191608	Splasher-side left assembly (Side wheel carrier) (Used on 905 only) .....	1	-	-	-	-
190932	Splasher-side right assembly (Used on 906 only) .....	1	-	-	-	-
191606	Splasher-side right assembly (Side wheel carrier) (Used on 906 only) .....	1	-	-	-	-
190936	Splasher-side right assembly (Used on 905 only) .....	1	-	-	-	-
191610	Splasher-side right assembly (Side wheel carrier) (Used on 905 only) .....	1	-	-	-	-
205917	Splasher-side left (Used on 1005-1107) .....	-	1	1	-	-
205915	Splasher-side left (Used on 1006-1108) .....	-	1	1	-	-
219457	Splasher-side left (Used with bodies D858-D859) .....	-	-	1	-	-
219458	Splasher-side right (Used with bodies D858-D859) .....	-	-	1	-	-
205918	Splasher-side right (Used on 1005-1107) .....	-	1	1	-	-
205916	Splasher-side right (Used on 1006-1108) .....	-	1	1	-	-
209366	Splasher-side left (Used on 1005-1107) (Side wheel carrier) .....	-	1	1	-	-
209364	Splasher-side left (Used on 1006-1108) (Side wheel carrier) .....	-	1	1	-	-
209367	Splasher-side right (Used on 1005-1107) (Side wheel carrier) .....	-	1	1	-	-
209365	Splasher-side right (Used on 1006-1108) (Side wheel carrier) .....	-	1	1	-	-
215000	Splasher-side to body felt .....	-	-	1	-	-
190246	Splasher-side bolt hole cover .....	-	-	2	-	-
7852	Splasher-side to frame bolt .....	-	-	2	-	-
5427	Screw 5/16-24 x 1/2" hex. hd. ....	-	-	2	-	-
5502	Lockwasher 1/4" .....	-	-	2	-	-
5504	Lockwasher 5/16" .....	-	-	2	-	-
7004	Nut 1/4-28 .....	-	-	2	-	-
62065	Washer 1/4" .....	-	-	2	-	-
3874	Washer .....	-	-	2	-	-
7852	Splasher-side to frame bolt 1/4-28 x 7/8" hex. hd. ....	4	2	-	-	-
5427	Splasher-side to frame bolt 5/16-24 x 1/2" hex. hd. ....	-	2	-	-	-
5502	Lockwasher 1/4" .....	4	2	-	-	-
5504	Lockwasher 5/16" .....	-	2	-	-	-
7004	Nut 1/4-28 plain .....	4	2	-	-	-
62065	Washer 17/64 x 3/4" plain .....	4	2	-	-	-
3874	Washer 5/16" plain .....	-	2	-	-	-
191189	Splasher-side to frame liner .....	2	-	-	-	-
205761	Splasher-side to frame liner .....	-	2	2	-	-
194774	Rivet 5/32 x 1/4" split .....	2	-	-	-	-
190327	Splasher-side to front fender liner .....	2	-	-	-	-
190246	Splasher-side spring bolt hole cover .....	2	2	-	-	-
190741	Splasher-side to running board liner (Used on 906 only). ..	2	-	-	-	-
190740	Splasher-side to running board liner (Used on 905 only). ..	2	-	-	-	-
209710	Splasher-side to running board and front fender liner (Used on 1005-1107) .....	-	1	2	-	-
209709	Splasher-side to running board and front fender liner (Used on 1006-1108) .....	-	1	2	-	-

Piece No.	Name	No. Required				
		905 906	1005 1006	1107 1108	1207 1208	1407 1408
7827	Splasher-side to running board screw 1/4-28 x 3/4" .....	20	22	22	-	-
5502	Lockwasher 1/4" .....	20	22	22	-	-
7004	Nut 1/4-28 plain .....	20	22	22	-	-
62065	Plain washer .....	20	22	22	-	-

SPLASHER

221881	Splasher-frame to crankcase front .....	-	-	-	1	1
5786	Screw 1/4-28 x 7/8" hex. hd. ....	-	-	-	2	2
7827	Screw 1/4-28 x 3/4" hex. hd. ....	-	-	-	2	2
7824	Screw 1/4-28 x 5/8" hex. hd. ....	-	-	-	4	4
7004	Nut 1/4-28 .....	-	-	-	8	8
5502	Lockwasher 1/4" .....	-	-	-	8	8
62065	Washer 1/4 special .....	-	-	-	4	4
3868	Washer 1/4" .....	-	-	-	8	8
223762	Splasher-frame to crankcase left assembly .....	-	-	-	1	1
223761	Splasher-frame to crankcase right assembly .....	-	-	-	1	-
230317	Splasher-frame to crankcase right assembly .....	-	-	-	-	1
7827	Screw 1/4-28 x 3/4" .....	-	-	-	12	10
7809	Screw 5/16-24 x 7/8" hex. hd. ....	-	-	-	2	2
7004	Nut 1/4-28 .....	-	-	-	14	10
5502	Lockwasher 1/4" .....	-	-	-	14	10
3874	Washer 5/16 plain .....	-	-	-	2	2
62065	Washer 1/4 special .....	-	-	-	10	8
5504	Lockwasher 5/16" .....	-	-	-	2	2
3868	Washer 1/4 .....	-	-	-	2	2
225599	Splasher-frame to crankcase brace .....	-	-	-	2	2
7824	Screw 1/4-28 x 5/8" (right) .....	-	-	-	2	2
7826	Screw 5/16-24 x 5/8 hex. hd. ....	-	-	-	2	2
7004	Nut 1/4-28 .....	-	-	-	2	2
3868	Washer 1/4" .....	-	-	-	2	2
3874	Washer 5/16" .....	-	-	-	2	2
5502	Lockwasher 1/4" .....	-	-	-	2	2
5504	Lockwasher 5/16" .....	-	-	-	2	2
223844	Splasher-frame to crankcase to frame front liner .....	-	-	-	2	2
223845	Splasher-frame to crankcase to frame front intermediate liner .....	-	-	-	6	6
223846	Splasher-frame to crankcase to frame rear intermediate liner .....	-	-	-	2	2
215993	Splasher-frame to crankcase to frame rear liner .....	-	-	-	2	2
223847	Splasher-frame to crankcase front to cross member liner. ....	-	-	-	1	1
223849	Splasher-frame to crankcase to splasher front liner ....	-	-	-	2	2

SPRINGS

180212	Spring front block .....	2	2	2	2	2
180800	Spring front bolt-front .....	2	2	2	-	-
223485	Spring front bolt-front .....	-	-	-	2	2
132012	Spring front bolt-front nut .....	-	-	-	2	2
4320	Cotter pin 5/32 x 1-1/8" .....	-	-	-	2	2
225018	Spring front bolt-front washer .....	-	-	-	2	2
228603	Spring front bolt-front thrust washer assembly .....	-	-	-	4	4
223486	Spring front bolt-rear .....	-	-	-	2	2
180339	Spring front bolt-rear .....	2	2	2	-	-
7009	Nut 9/16-18 .....	4	4	4	-	-
132012	Nut .....	-	-	-	2	2
4320	Cotter pin 5/32 x 1-1/8" .....	-	-	-	2	2

Piece No.	Name	No. Required				
		905 906	1005 1006	1107 1108	1207 1208	1407 1408
225018	Washer .....	-	-	-	2	2
228603	Thrust washer assembly .....	-	-	-	4	4
5807	Lockwasher 9/16" Shakeproof .....	4	4	4	-	-
180550	Washer .....	4	4	4	-	-
194578	Spring washer-inner .....	4	4	4	-	-
194579	Spring washer-outer .....	4	4	4	-	-
180762	Spring front bracket rear trunnion assembly .....	1	1	1	-	-
223487	Spring front bracket rear trunnion assembly .....	-	-	-	1	1
179247	Spring front bracket rear trunnion bushing .....	1	1	1	1	1
180341	Spring front bracket trunnion bolt .....	1	1	1	1	1
5807	Lockwasher 9/16" Shakeproof .....	1	1	1	1	1
7009	Nut 9/16-18 SAE .....	1	1	1	1	1
180550	Washer .....	1	1	1	1	1
64383	Spring front bushing .....	4	4	4	4	4
194578	Spring washer-inner .....	1	1	1	1	1
194579	Spring washer-outer .....	1	1	1	1	1
180758	Spring front bracket rear trunnion spring .....	4	4	4	4	4
180209	Spring front clip .....	4	4	4	4	4
139515	Spring clip nut .....	8	8	8	8	8
5510	Lockwasher 1/2" .....	8	8	8	8	8
23731	Spring front center bolt and nut .....	2	2	2	2	2
180368	Spring front and cover assembly left (2-1/4 x 42 x 950 lb. x 325 rate) (Prior to frame No. 900432) .....	1	-	-	-	-
186032	Spring front and cover assembly left (2-1/4 x 42 x 950 lb. x 375 rate) .....	1	-	-	-	-
180370	Spring front and cover assembly right (2-1/4 x 42 x 1050 lb. x 325 rate) (Prior to frame No. 900432) .....	1	-	-	-	-
180370	Spring front and cover assembly (2-1/4 x 42 x 1050 lb. x 325 rate) (Used after frame No. 900431) .....	2	-	-	-	-
186033	Spring front and cover assembly right (2-1/4 x 42 x 1050 lb. x 375 rate) .....	1	-	-	-	-
209766	Spring front and cover assembly (2-1/4 x 42 x 1075 lb. x 300 rate) .....	-	2	2	-	-
209996	Spring front and cover assembly (2-1/4 x 42 x 1075 lb. x 375 rate) .....	-	2	2	-	-
210000	Spring front and cover assembly (2-1/4 x 42 x 1075 lb. x 425 rate) .....	-	2	2	-	-
221786	Spring front and cover assembly (2-1/4 x 42 x 1175 lb. x 275 rate) .....	-	-	-	2	-
221786	Spring front and cover assembly (2-1/4 x 42 x 1175 lb. x 275 rate) (Used with bodies 932-3-4-5-6-7-8) .....	-	-	-	-	2
230348	Spring front and cover assembly (2-1/4 x 42 x 1175 lb. x 225 rate) (Used with bodies 921-31-27-39-30-73- L-294-L-295) .....	-	-	-	-	2
221788	Spring front and cover assembly (2-1/4 x 42 x 1175 lb. x 375 rate) .....	-	-	-	2	-
180358	Spring front cover canvas front .....	2	2	2	2	2
180357	Spring front cover canvas rear .....	2	2	2	2	2
195943	Spring front main leaf .....	2	2	2	2	2
147298	Spring front rubber bumper .....	2	2	2	-	-
196934	Spring front rubber bumper .....	-	-	-	2	2
135910	Spring front rubber bumper bracket .....	2	2	2	2	2
7810	Screw 5/16-24 x 1-1/4" hex. hd. ....	3	4	4	4	4
5762	Screw 5/16-24 x 1-3/8" hex. hd. ....	1	-	-	-	-
7005	Nut 5/16-24 plain hex. hd. ....	4	4	4	-	-
5504	Lockwasher 5/16" .....	4	4	4	4	4
180800	Spring front shackle bracket bolt .....	2	2	2	-	-
223485	Spring front shackle bracket bolt .....	-	-	-	2	2
132012	Nut .....	-	-	-	2	2

SERVICE PARTS LIST—PACKARD TWELVE

Spring 173

Piece No.	Name	No. Required				
		905 906	1005 1006	1107 1108	1207 1208	1407 1408
4320	Cotter pin 5/32 x 1-1/8" .....	-	-	-	2	2
228603	Thrust washer assembly .....	-	-	-	4	4
225018	Washer .....	-	-	-	2	2
5807	Lockwasher 9/16" .....	2	2	2	-	-
7009	Nut 9/16-18 .....	2	2	2	-	-
194578	Spring washer-inner .....	2	2	2	-	-
194579	Spring washer-outer .....	2	2	2	-	-
180550	Washer .....	2	2	2	-	-
180581	Spring front shackle link-inner .....	2	2	2	-	-
180912	Spring front shackle link-outer .....	2	2	2	-	-
180581	Spring front shackle link-outer .....	-	-	-	2	2
210358	Spring front shackle link-inner .....	-	-	-	2	2
184810	Spring front shackle link oil restriction .....	2	-	-	-	-
186696	Spring rear block-right .....	1	1	1	-	-
221859	Spring rear block-right .....	-	-	-	1	1
186697	Spring rear block-left .....	1	1	1	-	-
221858	Spring rear block-left .....	-	-	-	1	1
180340	Spring rear bolt-front .....	2	2	2	2	2
180801	Spring rear bolt-rear .....	2	2	2	2	2
7009	Nut 9/16-18 .....	4	4	4	4	2
5807	Lockwasher 9/16" .....	4	4	4	4	2
180550	Spring rear bolt-front washer .....	4	4	4	4	2
194578	Spring rear bolt-front spring washer-inner .....	4	4	4	4	2
194579	Spring rear bolt-front spring washer-outer .....	4	4	4	4	2
185435	Spring rear bushing .....	4	4	4	4	4
179157	Spring rear-clip .....	4	4	4	4	4
62455	Nut .....	8	8	8	8	8
5514	Lockwasher 5/8" .....	8	8	8	8	8
23731	Spring rear center bolt and nut .....	2	2	2	2	2
180384	Spring rear and cover assembly (2-1/2 x 60-1/2 x 1100 lb. x 145 rate) (Used on bodies 571-581) .....	2	-	-	-	-
180386	Spring rear and cover assembly (2-1/2 x 60-1/2 x 1200 lb. x 145 rate) (Used on bodies 577-8-9-583-7-631- 641-731-741-838-938) .....	2	2	2	2	2
180388	Spring rear and cover assembly (2-1/2 x 60-1/2 x 1300 lb. x 145 rate) (Used on bodies 573-6-637-638-9- 738-739) .....	2	2	2	-	-
180390	Spring rear and cover assembly (2-1/2 x 60-1/2 x 1400 lb. x 145 rate) (Used on bodies 574-5-636-633-5633- 5633-A-643-4000-1-2-3) .....	2	2	-	-	-
180394	Spring rear and cover assembly (2-1/2 x 60-1/2 x 1200 lb. x 145 rate) (Used on bodies 570-821-31-37-39-937- 21-31-39) .....	2	-	-	2	2
180398	Spring rear and cover assembly (2-1/2 x 60-1/2 x 1400 lb. x 165 rate) (Used on bodies 574-5-732-33-36-43- 834-835-L194-L195-934-35-L294-L295) .....	2	-	2	2	2
194714	Spring rear and cover assembly (2-1/2 x 60-1/2 x 1400 lb. x 200 rate) .....	2	-	-	-	-
180396	Spring rear and cover assembly (2-1/2 x 60-1/2 x 1300 lb. x 165 rate) (Used on bodies 630-730-37-47-827-32- 33-36-873-830-930-32-33-27-36-73) .....	-	2	2	2	2
209568	Spring rear and cover assembly (2-1/2 x 60-1/2 x 1500 lb. x 145 rate) (Used on bodies 634-635-D758-D759) ...	-	2	2	-	-
207239	Spring rear and cover assembly (2-1/2 x 60-1/2 x 1500 lb. x 165 rate) (Used on bodies 574-575-634-635-734- 5-D858-D859-834-5) .....	2	2	2	2	-
209562	Spring rear and cover assembly (2-1/2 x 60-1/2 x 1500 lb. x 250 rate) (Used on bodies 634-635-734-735) .....	-	2	2	-	-
210562	Spring rear and cover assembly (2-1/2 x 60-1/2 x 1600 lb. x 165 rate) (Used on bodies 634-635-734-735) .....	-	2	2	-	-

Piece No.	Name	No. Required				
		905 906	1005 1006	1107 1108	1207 1208	1407 1408
228786	Spring rear and cover assembly (2-1/2 x 60-1/2 x 1500 lb. x 185 rate) (Used on bodies 834-835) .....	-	-	-	-	2
NOTE: See spring chart for spring covers.						
180358	Spring rear cover canvas .....	4	4	4	4	4
195942	Spring rear main leaf .....	2	2	2	2	2
186242	Spring rear rubber bumper .....	2	2	2	2	2
186243	Spring rear rubber bumper bracket .....	2	2	2	2	2
213833	Spring rear rubber bumper bracket spacer (Used on bodies 643-743-D758-D759-D858-D859) .....	-	2	2	-	-
6269	Screw 3/8-24 x 2-1/4" hex. hd. (Used on bodies 643-743-D758-D759-D858-D859) .....	-	4	4	-	-
7822	Screw 3/8-24 x 1-1/2" hex. hd. (Not used on bodies 643-743-D758-D759-D858-D859) .....	4	4	4	4	4
5506	Lockwasher 3/8" .....	4	4	4	4	4
7006	Nut 3/8-24 .....	4	4	4	4	4
180801	Spring rear shackle bolt .....	2	2	2	2	2
7009	Nut 9/16-18 thd. ....	2	2	2	2	2
5807	Lockwasher 9/16" Shakeproof .....	2	2	2	2	2
180550	Washer .....	2	2	2	2	2
194578	Spring washer-inner .....	2	2	2	2	2
194579	Spring washer-outer .....	2	2	2	2	2
180799	Spring rear shackle link-inner .....	2	2	2	2	2
180913	Spring rear shackle link-outer .....	2	2	2	2	2
184810	Spring rear shackle link oil restriction .....	2	-	-	-	-
180798	Spring rear shackle link stop pin .....	2	2	2	2	2
7006	Nut 3/8-24 plain .....	2	2	2	2	2
5506	Lockwasher 3/8" .....	2	2	2	2	2

## STARTER SWITCH (Automatic)

194791	Automatic starter switch assembly (Black serial plate) .	1	1	1	-	-
219745	Automatic starter switch assembly (Serial plate-Red) (Used with CO-1241 generator) .....	-	-	1	1	1
205032	Automatic starter switch bracket .....	2	2	2	2	2
7801	Bolt 1/4-28 x 1-1/2" hex. hd. ....	2	2	2	2	2
5502	Lockwasher 1/4" .....	2	2	2	2	2
7004	Nut 1/4-28 .....	2	2	2	2	2
146955	Automatic starter switch cable clamps .....	3	1	1	1	1
203905	Automatic starter switch cable clamps .....	-	2	2	2	2
201558	Automatic starter switch safety cutout .....	1	1	1	-	-
225856	Automatic starter switch cutout adopter .....	-	-	-	1	1
203922	Automatic starter switch safety cutout union connection assembly .....	1	-	-	-	-
205073	Automatic starter switch to safety cutout cable asb. ...	1	-	-	-	-
202922	Automatic starter switch to safety cutout cable asb. ...	-	1	1	1	1
205074	Automatic starter switch to starter motor cable assembly (Starter motor terminal) .....	1	1	1	1	-
231009	Automatic starter switch to starter motor cable assembly (Starter motor terminal) .....	-	-	-	-	1
205075	Automatic starter switch to starter motor cable assembly (Battery terminal) .....	1	1	1	1	-
231007	Automatic starter switch to starter motor cable assembly (Battery terminal) .....	-	-	-	-	1
194802	Automatic starter ignition switch to safety cutout cable assembly .....	1	-	-	-	-
194750	Automatic starter ignition switch to safety cutout cable assembly .....	-	1	-	-	-

Piece No.	Name	No. Required				
		905 906	1005 1006	1107 1108	1207 1208	1407 1408

FRONT SPRING COVER CHART

Spring and Cover Number	Front Half of Spring					Rear Half of Spring				
	Canvas	"A" Cover	"B" Cover	"C" Cover	"D" Cover	Canvas	"E" Cover	"F" Cover	"G" Cover	"H" Cover
	180368	180356	180401	180402	180403	180404	180357	180401	180405	180406
180370	180356	180401	180402	180403	180404	180357	180401	180405	180406	180407
186032	180356	180401	180402	180403	180404	180357	180401	180405	180406	180407
186033	180356	180401	180402	180403	180404	180357	180401	180405	180406	180407
209766	180356	180401	180402	180403	180404	180357	180401	180405	180406	180407
209996	180356	180401	180402	180403	180404	180357	180401	180405	180406	180407
210000	180356	180401	180402	180403	180404	180357	180401	180405	180406	180407
221786	180356	180401	180402	180403	180404	180357	180401	180405	180406	180407
221788	180356	180401	180402	180403	180404	180357	180401	180405	180406	180407
230348	180356	209293	209292	175026	175011	180357	209293	209291	175026	175011

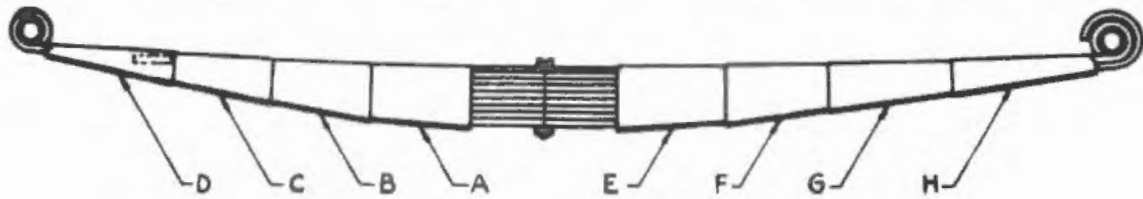

REAR SPRING COVER CHART

Spring and Cover Number	Front Half of Spring						Rear Half of Spring					
	Canvas	"A" Cover	"B" Cover	"C" Cover	"D" Cover	"E" Cover	Canvas	"F" Cover	"G" Cover	"H" Cover	"I" Cover	"J" Cover
	180384	180358	180411	180413	180414	180415	180416	180358	180411	180413	180414	180415
180386	180358	180411	180413	180414	180415	180416	180358	180411	180413	180414	180415	180416
180388	180358	180412	180413	180414	180415	180416	180358	180412	180413	180414	180415	180416
180394	180358	180411	180413	180414	180415	180416	180358	180411	180413	180414	180415	180416
180390	180358	180412	180413	180414	180415	180416	180358	180412	180413	180414	180415	180416
180398	180358	180411	180413	180414	180415	180416	180358	180411	180413	180414	180415	180416
194714	180358	180411	180413	180414	180415	180416	180358	180411	180413	180414	180415	180416
207239	180358	180412	180413	180414	180415	180416	180358	180412	180413	180414	180415	180416
180396	180358	180411	180413	180414	180415	180416	180358	180411	180413	180414	180415	180416
200568	180358	180412	180413	180414	180415	180416	180358	180412	180413	180414	180415	180416
207239	180358	180412	180413	180414	180415	180416	180358	180412	180413	180414	180415	180416
209562	180358	180417	180412	180413	180414	180415	180358	180417	180412	180413	180414	180415
210562	180358	180412	180413	180414	180415	180416	180358	180412	180413	180414	180415	180416
228786	180358	180412	180413	180414	180415	180416	180358	180412	180413	180414	180415	180416

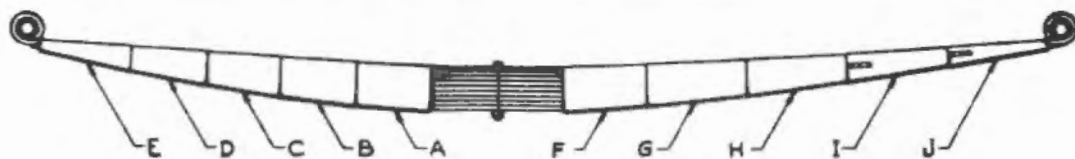



Piece No.	Name	No. Required				
		905 906	1005 1006	1107 1108	1207 1208	1407 1408
<b>STEERING CONNECTING ROD</b>						
201871	Steering connecting rod assembly .....	-	1	1	-	-
223378	Steering connecting rod assembly .....	-	-	-	1	1
190824	Steering connecting rod .....	1	-	-	-	-
201870	Steering connecting rod .....	-	1	1	-	-
223377	Steering connecting rod .....	-	-	-	1	1
4312	Cotter 1/8 x 1-3/4" .....	2	2	2	-	-
4559	Lubricator plug (1/8 headless) .....	-	-	-	2	2
216548	Alemite connection-front (Alemite-Zerk type 1600) ..	-	-	1	-	-
216549	Alemite connection-rear (Alemite-Zerk type No. 1612)	-	-	1	-	-
114955	Alemite connection (Type "A" male) (Used after steering Unit No. 900580) .....	2	2	2	-	-
116272	Dust cap (Alemite) (Used after steering Unit No. 900580) .....	2	2	2	-	-
156971	Steering connecting rod ball joint spacer .....	2	-	-	-	-
209229	Steering connecting rod ball joint spacer .....	-	2	2	1	1
116316	Steering connecting rod ball socket .....	3	-	-	-	-
197024	Steering connecting rod ball socket (Used after steering Unit No. 900580) .....	1	-	-	-	-
209226	Steering connecting rod ball socket .....	-	4	4	4	4
114198	Steering connecting rod ball socket dust cover .....	2	2	2	2	2
128008	Steering connecting rod ball socket dust cover clamp assembly .....	2	2	2	2	2
3729	Screw No. 10-32 x 1-1/4" round head .....	4	4	4	4	4
5500	Lockwasher No. 10 .....	4	4	4	4	4
7003	Nut No. 10-32 .....	4	4	4	4	4
116313	Steering connecting rod ball socket spring .....	2	-	-	-	-
209227	Steering connecting rod ball socket spring .....	-	2	-	2	2
207637	Steering connecting rod ball socket shim-1/2" thick ....	-	1	1	1	1
207638	Steering connecting rod ball socket shim-1/8" thick ....	-	3	3	3	3
207639	Steering connecting rod ball socket shim-1/16" thick ...	-	1	1	1	1
207640	Steering connecting rod ball socket shim-1/32" thick ...	-	2	2	2	2
209228	Steering connecting rod plug .....	-	-	2	2	2
4312	Cotter pin 1/8 x 1-3/4" .....	-	-	2	2	2

**STEERING GEAR—PACKARD GEAR**

(Prior to steering unit No. 900581)

203800	Steering gear assembly .....	1	-	-	-	-
197026	Steering gear case .....	1	-	-	-	-
7808	Clamp bolt (Screw 5/16-24 x 1-15/16" hex. hd.) .....	1	-	-	-	-
7005	Nut 5/16-24 .....	1	-	-	-	-
5504	Lockwasher 5/16" .....	1	-	-	-	-
202297	Steering gear case cover bottom .....	1	-	-	-	-
170006	Screw .....	2	-	-	-	-
5504	Lockwasher 5/16" .....	2	-	-	-	-
7815	Clamp screw 5/16-24 x 1-1/2" hex. hd. ....	1	-	-	-	-
7005	Nut 5/16-24 .....	1	-	-	-	-
5504	Lockwasher 5/16" .....	1	-	-	-	-
132131	Steering gear case cover bottom gasket .....	1	-	-	-	-
128541	Steering gear case cover bottom packing .....	2	-	-	-	-
126986	Steering gear case cover bottom packing nut .....	1	-	-	-	-
197027	Steering gear case cover side .....	1	-	-	-	-
5449	Screw 5/16-24 x 3/4" hex. hd. ....	5	-	-	-	-
7809	Screw 5/16-24 x 7/8" hex. hd. ....	1	-	-	-	-
5504	Lockwasher 5/16" .....	6	-	-	-	-
197028	Steering gear case cover side gasket .....	1	-	-	-	-

Piece No.	Name	No. Required				
		905 906	1005 1006	1107 1108	1207 1208	1407 1408
4559	Steering gear case plug 1/8" headless pipe plug .....	1	-	-	-	-
7885	Steering gear case to frame bolt 7/16-20 x 1-3/8" hex. hd. ....	4	-	-	-	-
5508	Lockwasher 7/16" .....	4	-	-	-	-
7007	Nut 7/16-20 .....	4	-	-	-	-
131046	Washer 7/16" special .....	4	-	-	-	-
107889	Steering gear case plug-flange plug 1-1/4" male .....	1	-	-	-	-
20075	Steering gear case plug gasket .....	1	-	-	-	-
207013	Steering gear lighting switch terminal block assembly (Supersedes No. 178009) .....	1	-	-	-	-
145662	Steering gear lighting switch base assembly .....	1	-	-	-	-
7709	Screw No. 10-32 x 7/16" fill. head .....	2	-	-	-	-
5500	Lockwasher No. 10 .....	2	-	-	-	-
190797	Steering pillar tube assembly .....	1	-	-	-	-
11425	Steering pillar tube upper end bearing .....	1	-	-	-	-
203795	Steering post clutch control shaft assembly .....	1	-	-	-	-
132167	Steering post clutch control shaft anti-rattler .....	1	-	-	-	-
171572	Steering post clutch control shaft upper and lever hub assembly .....	1	-	-	-	-
202305	Steering post clutch control shaft gear .....	1	-	-	-	-
5815	Screw No. 10-32 x 7/8" fill. head .....	1	-	-	-	-
5500	Lockwasher No. 10 .....	1	-	-	-	-
7003	Nut No. 10-32 .....	1	-	-	-	-
203777	Steering post clutch control shaft spacer .....	1	-	-	-	-
202320	Steering post clutch control valve pinion .....	1	-	-	-	-
202288	Steering post clutch control valve pinion shaft .....	1	-	-	-	-
207750	Steering post clutch control valve pinion shaft washer (Supersedes 186436) .....	1	-	-	-	-
202298	Steering post clutch control valve pinion retracting spring .....	1	-	-	-	-
202291	Steering post clutch control valve pinion retracting spring pin .....	1	-	-	-	-
203996	Steering post control cover .....	1	-	-	-	-
5702	Steering post control cover screw No. 10-32 x 7/16" carriage .....	4	-	-	-	-
5500	Lockwasher No. 10 .....	4	-	-	-	-
7003	Nut No. 10-32 .....	4	-	-	-	-
203980	Steering post control cover liner .....	1	-	-	-	-
174637	Steering post control cover spacer .....	2	-	-	-	-
171578	Steering post control cover support and tube assembly ..	1	-	-	-	-
132162	Steering post control cover support tube anti-rattler ..	2	-	-	-	-
203790	Steering post control handle .....	2	-	-	-	-
6179	Steering post control handle rivet 1/8 x 11/32" round head .....	3	-	-	-	-
6178	Steering post control handle rivet 1/8 x 11/32" countersunk hd. ....	3	-	-	-	-
203780	Steering post horn button and contact assembly .....	1	-	-	-	-
203997	Steering post horn button gasket .....	3	-	-	-	-
203819	Steering post horn button plate screw .....	3	-	-	-	-
5861	Lockwasher .....	3	-	-	-	-
203778	Steering post horn button spring .....	1	-	-	-	-
210886	Steering post horn button to horn cable assembly .....	1	-	-	-	-
176594	Steering post to instrument board bracket and cap .....	1	-	-	-	-
7820	Screw 3/8-24 x 1-3/8" hex. hd. ....	2	-	-	-	-
5506	Lockwasher 3/8" .....	2	-	-	-	-
3911	Washer 3/8" .....	2	-	-	-	-
175364	Steering post to instrument board bracket screw plate ..	1	-	-	-	-
7724	Screw 1/4-20 x 1" fill. head .....	2	-	-	-	-
5502	Lockwasher 1/4" .....	2	-	-	-	-

Piece No.	Name	No. Required				
		905 906	1005 1006	1107 1108	1207 1208	1407 1408
3907	Washer .....	2	-	-	-	-
203796	Steering post lighting switch control shaft assembly ...	1	-	-	-	-
203788	Steering post lighting switch control shaft assembly retainer .....	2	-	-	-	-
171196	Steering post lighting switch control shaft lever hub .....	1	-	-	-	-
171574	Steering post lighting switch control shaft spacer (Supersedes 203776) .....	1	-	-	-	-
191255	Steering post to toe board grommet .....	1	-	-	-	-
127012	Steering post upper end nut .....	1	-	-	-	-
203781	Steering wheel assembly .....	1	-	-	-	-
5135	Key 3/16 x 3/16 x 1-1/8" .....	1	-	-	-	-
170009	Steering worm .....	1	-	-	-	-
132121	Steering worm key .....	1	-	-	-	-
170018	Steering worm and post assembly .....	1	-	-	-	-
197035	Steering worm sector and shaft .....	1	-	-	-	-
7014	Nut 7/8-14 .....	1	-	-	-	-
5520	Lockwasher 7/8" .....	1	-	-	-	-
126985	Plain washer .....	1	-	-	-	-
175355	Steering worm sector and shaft bushing .....	1	-	-	-	-
169167	Steering worm sector and shaft bushing lock .....	1	-	-	-	-
7810	Screw 5/16-24 x 1-1/4" hex. hd. ....	1	-	-	-	-
5504	Lockwasher 5/16" .....	1	-	-	-	-
7005	Nut 5/16-24 .....	1	-	-	-	-
5681	Washer 5/16" special .....	1	-	-	-	-
132122	Steering worm sector adjusting screw .....	1	-	-	-	-
197036	Steering worm sector adjusting screw lock .....	1	-	-	-	-
5344	Steering worm sector shaft bushing lock clamp screw 1/4-28 x 1-3/4" fill. head .....	1	-	-	-	-
7004	Plain hex. nut 1/4-28 .....	1	-	-	-	-
3868	Washer 1/4" .....	1	-	-	-	-
5502	Lockwasher 1/4" .....	1	-	-	-	-
191693	Steering worm sector and shaft lever .....	1	-	-	-	-
132142	Ball joint .....	1	-	-	-	-
4551	Key No. 5 (Whitney Woodruff system) .....	1	-	-	-	-
7109	Nut 9/16-18 castle .....	1	-	-	-	-
4305	Cotter pin 1/8 x 7/8" .....	1	-	-	-	-
114211	Steering worm sector and shaft lever ball joint cup washer .....	2	-	-	-	-
114316	Plain washer .....	1	-	-	-	-
201741	Steering worm sector and shaft oil seal .....	1	-	-	-	-
159879	Steering worm sector and shaft thrust bearing-inner ....	1	-	-	-	-
159878	Steering worm sector and shaft bearing-outer .....	1	-	-	-	-
176595	Steering worm thrust bearing assembly (Timken) .....	2	-	-	-	-
170003	Steering worm thrust bearing adjusting nut .....	1	-	-	-	-

## STEERING GEAR—GEMMER GEAR

(After steering unit No. 900580)

209910	Steering gear assembly (37-15/32" long from top of case to bottom of steering wheel hub) .....	1	-	-	-	-
213240	Steering gear assembly (37-15/32" long from top of case to bottom of steering wheel hub) .....	-	1	-	-	-
215034	Steering gear assembly (37-1/8" long from top of adjusting nut to bottom of steering wheel hub) .....	-	-	1	-	-
216859	Steering gear assembly (38-1/8" long from top of adjusting nut to bottom of steering wheel hub) .....	-	-	1	-	-
223325	Steering gear assembly .....	-	-	-	1	-

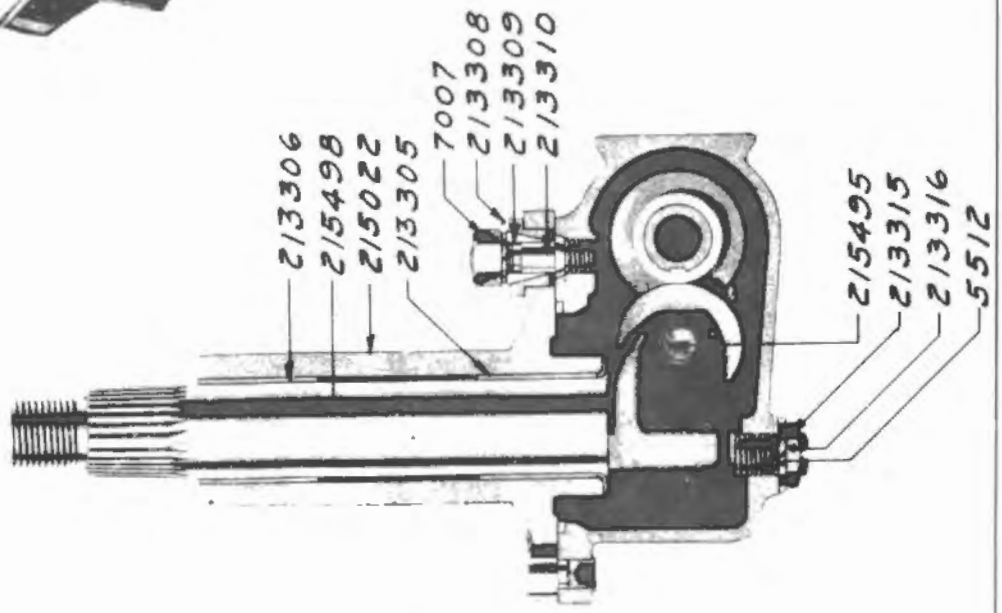
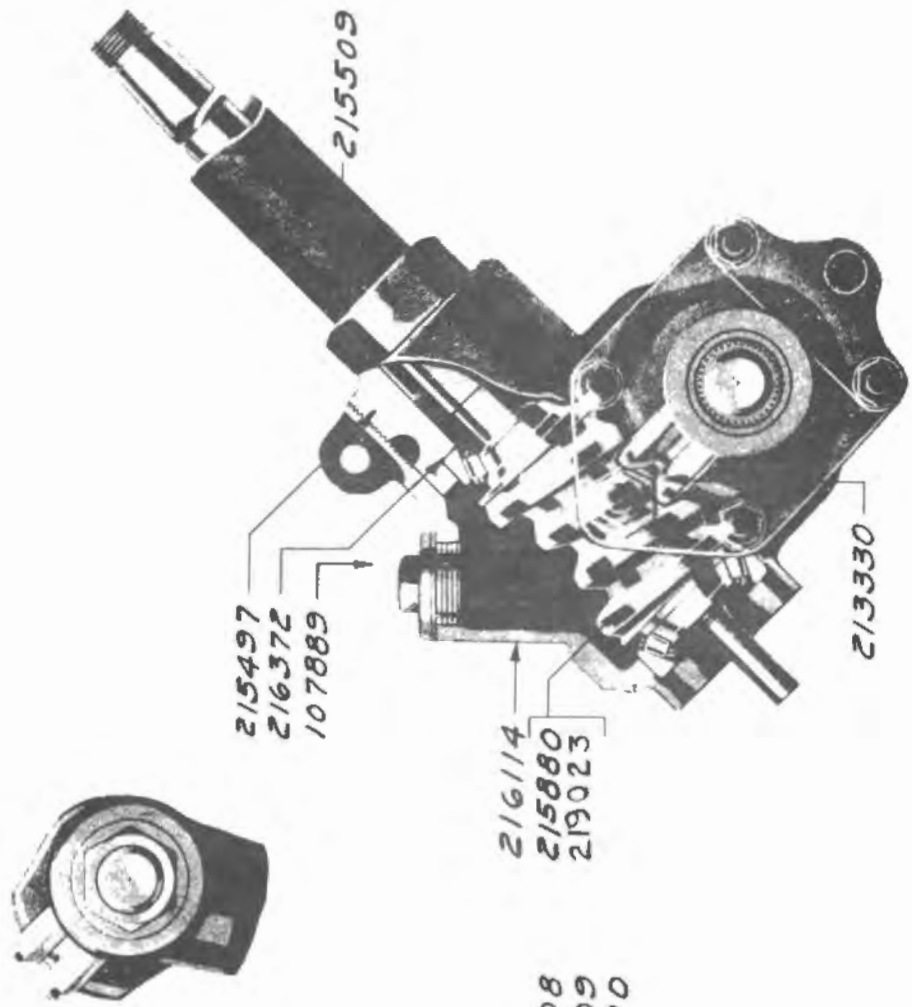

1107-1108

Piece No.	Name	No. Required				
		905 906	1003 1006	1107 1108	1207 1208	1407 1408
230342	Steering gear assembly .....	-	-	-	-	1
213300	Steering gear case assembly .....	1	1	-	-	-
215503	Steering gear case (Supersedes No. 216114) .....	-	-	1	1	1
7836	Clamp bolt .....	1	1	-	-	-
5508	Lockwasher .....	1	1	-	-	-
7007	Nut .....	1	1	-	-	-
7845	Clamp bolt .....	-	-	1	1	1
7006	Nut .....	-	-	1	1	1
5506	Lockwasher 3/8" .....	-	-	1	1	1
213303	Steering gear case cover assembly .....	1	1	-	-	-
215022	Steering gear case cover assembly .....	-	-	1	-	-
223323	Steering gear case cover assembly .....	-	-	-	1	1
213305	Steering gear case cover bushing-inner .....	1	1	1	1	1
213306	Steering gear case cover bushing-outer .....	1	1	1	1	1
213307	Steering gear case cover stud .....	4	4	4	4	4
5508	Lockwasher .....	4	4	-	-	4
216222	Lockwasher .....	-	-	4	4	4
216371	Nut .....	4	4	4	4	4
213311	Steering gear case cover centralizing rivet .....	1	1	1	1	1
209751	Steering gear case cover bottom .....	1	-	-	-	-
209543	Steering gear case cover bottom .....	-	1	1	1	1
209853	Screw .....	2	-	-	-	-
209572	Screw .....	-	2	2	2	2
5502	Lockwasher .....	2	2	2	2	2
7815	Clamp screw 5/16-24 x 1-1/2" hex. hd. ....	1	1	1	1	1
7005	Nut 5/16-24 .....	1	1	1	1	1
5504	Lockwasher 5/16" .....	1	1	1	1	1
209544	Steering gear case cover bottom gasket .....	1	1	1	1	1
128541	Steering gear case cover bottom packing .....	2	2	2	2	2
126986	Steering gear case cover bottom packing nut .....	1	1	1	1	1
213308	Steering gear case cover eccentric sleeve .....	1	1	1	1	1
213310	Stud .....	1	1	1	1	1
5728	Lockwasher .....	1	1	1	1	1
216371	Nut .....	1	1	1	1	1
213309	Steering gear case cover eccentric sleeve lock ring ...	1	1	1	1	1
213312	Steering gear case cover gasket .....	1	1	1	1	1
7885	Steering gear case to frame bolt 7/16-20 x 1-3/8" hex. hd. ....	4	4	4	-	-
5929	Steering gear case to frame bolt 7/16-20 x 1-5/8" hex. hd. ....	-	-	-	4	4
5508	Lockwasher 7/16" .....	4	4	4	4	4
7007	Nut 7/16-20 .....	4	4	4	4	4
131046	Washer 7/16" special .....	4	4	4	4	4
223382	Steering gear case to frame spacer .....	-	-	-	1	1
213302	Steering gear case oil filler plug .....	1	1	-	-	-
107889	Steering gear case oil filler plug .....	-	-	1	1	1
220075	Steering gear case oil filler plug gasket .....	-	-	1	1	1
213313	Steering gear cross shaft assembly .....	1	1	-	-	-
215498	Steering gear cross shaft assembly .....	-	-	1	1	1
213315	Steering gear cross shaft adjusting screw .....	1	1	1	1	1
5512	Lockwasher .....	1	1	1	1	1
213316	Steering gear cross shaft adjusting screw lock nut ....	1	1	1	1	1
215927	Steering gear cross shaft lever .....	-	-	1	-	-
223417	Steering gear cross shaft lever .....	-	-	-	1	1
197145	Ball joint .....	-	-	1	1	1
7109	Nut 9/16-18 castle .....	-	-	1	1	1
4305	Cotter pin .....	-	-	1	1	1
114211	Steering gear cross shaft lever ball joint cup washer ..	-	-	2	2	2
114316	Washer .....	-	-	1	1	1

SERVICE PARTS LIST—PACKARD TWELVE

Steering Gear 183

Piece No.	Name	No. Required				
		905 906	1005 1006	1107 1108	1207 1208	1407 1408
210196	Steering gear cross shaft oil seal .....	-	-	1	1	-
223415	Steering gear cross shaft oil seal .....	-	-	-	1	1
210197	Steering gear cross shaft oil seal retainer .....	-	-	1	1	1
213438	Steering gear cross shaft nut .....	1	1	1	1	1
5520	Steering gear cross shaft nut lockwasher .....	1	1	1	1	1
213330	Steering gear cross shaft roller .....	1	1	1	1	1
213332	Steering gear cross shaft roller pin .....	1	1	-	-	-
215495	Steering gear cross shaft roller pin .....	-	-	1	1	1
213331	Steering gear cross shaft roller washer (Supersedes 215492-215493-215494) .....	2	2	2	2	2
216101	Steering gear lighting switch base assembly .....	-	-	1	-	-
225648	Steering gear lighting switch base assembly .....	-	-	-	1	1
209850	Steering gear lighting switch base assembly .....	1	-	-	-	-
209456	Steering gear lighting switch base assembly .....	-	1	-	-	-
7709	Screw No. 10-32 x 7/16" fill. head .....	2	-	-	-	-
5500	Lockwasher No. 10 .....	2	-	-	-	-
7003	Steering gear lighting switch base retaining nut No. 10-32 .....	-	2	2	2	2
5500	Lockwasher No. 10 .....	-	2	2	2	2
3866	Washer .....	-	2	2	2	2
209463	Steering gear lighting switch terminal block assembly ..	-	1	1	-	-
209527	Steering pillar tube assembly 38-15/32" long .....	1	1	-	-	-
215509	Steering pillar tube assembly 40-11/16" long .....	-	-	1	-	-
216838	Steering pillar tube assembly 41-11/16" long .....	-	-	1	1	1
223199	Steering pillar tube bushing (Supersedes 219557) .....	1	1	1	1	1
213327	Steering pillar tube clamp assembly .....	1	1	-	-	-
5753	Bolt 5/16-24 x 1-7/8" hex. hd. ....	1	1	-	-	-
5504	Lockwasher 5/16" .....	1	1	-	-	-
7005	Nut 5/16-24 .....	1	1	-	-	-
213328	Steering pillar tube oil hole cover .....	1	1	1	-	-
213325	Steering post upper end nut .....	1	1	-	-	-
203795	Steering post clutch control shaft assembly .....	1	-	-	-	-
132167	Steering post clutch control shaft anti-rattler .....	1	-	-	-	-
171572	Steering post clutch control shaft upper and lever hub assembly .....	1	-	-	-	-
202305	Steering post clutch control shaft gear .....	1	-	-	-	-
5387	Screw No. 10-32 x 7/8" fill. head .....	1	-	-	-	-
5500	Lockwasher No. 10 .....	1	-	-	-	-
7003	Nut No. 10-32 .....	1	-	-	-	-
203777	Steering post clutch control shaft spacer .....	1	-	-	-	-
202320	Steering post clutch control valve pinion .....	1	-	-	-	-
202288	Steering post clutch control valve pinion shaft .....	1	-	-	-	-
207750	Steering post clutch control valve pinion shaft washer .	1	-	-	-	-
202298	Steering post clutch control valve pinion retracting spring .....	1	-	-	-	-
202291	Steering post clutch control valve pinion retracting spring pin .....	1	-	-	-	-
203996	Steering post control cover assembly .....	1	1	1	1	1
5702	Steering post control cover screw No. 10-32 x 7/16" carriage .....	4	4	4	4	4
5500	Lockwasher No. 10 .....	4	4	4	4	4
7003	Nut No. 10-32 .....	4	4	4	4	4
6195	Steering post control cover horn button retainer rivet 3/32 x 3/16 countersunk head .....	-	-	-	6	6
5435	Washer No. 8 .....	-	-	-	3	3
203980	Steering post control cover liner .....	1	1	1	1	1
174637	Steering post control cover spacer .....	2	2	2	2	2
171578	Steering post control cover support and tube assembly (49" long overall) (Prior to steering unit No. 901202)	1	1	-	-	-

Piece No.	Name	No. Required				
		905 906	1005 1006	1107 1108	1207 1208	1407 1408
210827	Steering post control cover support and tube assembly (49" long overall) (After steering unit No. 901201) ..	-	1	1	-	-
216845	Steering post control cover support and tube assembly (50" long overall) .....	-	-	1	1	1
132162	Steering post control cover support tube anti-rattler (Prior to steering unit No. 901202) .....	2	2	-	-	-
216115	Steering post control cover support tube anti-rattler (After steering unit No. 901201) (Supersedes 210878) .	-	2	2	2	2
203790	Steering post control handle .....	2	-	-	-	-
6178	Rivet 1/8 x 11/32" countersunk head .....	1	-	-	-	-
6179	Rivet 1/8 x 11/32" round head .....	3	-	-	-	-
203819	Steering post horn button screw .....	3	3	3	3	3
5861	Lockwasher No. 8 Shakeproof .....	3	3	3	3	3
203780	Steering post horn button and contact assembly .....	1	1	1	1	1
203997	Steering post horn button gasket .....	1	1	3	3	3
203778	Steering post horn button spring .....	1	1	1	1	1
210886	Steering post horn button to horn cable assembly .....	1	1	-	-	-
215050	Steering post horn button to horn cable assembly .....	-	-	1	-	-
225279	Steering post horn button to horn cable assembly .....	-	-	-	1	1
176594	Steering post to instrument board bracket and cap (Use with post 46-7/16" long) .....	1	1	1	-	-
219716	Steering post to instrument board bracket and cap (Use with post 47-7/16" long) .....	-	-	1	-	-
225274	Steering post to instrument board bracket and cap .....	-	-	-	1	1
7820	Screw 3/8-24 x 1-3/8" hex. hd. ....	2	2	2	-	-
5506	Lockwasher 3/8" .....	2	2	2	-	-
3911	Washer 3/8" "Y" std. ....	2	2	2	-	-
175364	Steering post to instrument board bracket screw plate ..	1	-	-	-	-
210053	Steering post to instrument board bracket screw plate ..	-	1	1	-	-
7724	Steering post to instrument board bracket cap screw 1/4-20 x 1" fill. head .....	2	2	2	2	2
5502	Lockwasher 1/4" .....	2	2	2	2	2
3907	Washer 1/4" "Y" std. ....	2	2	2	2	2
223713	Steering post to instrument board bracket clamp plate ..	-	-	-	1	1
6077	Screw 1/2-20 x 3/8" hex. hd. ....	-	-	-	1	1
5133	Washer 1/2" plain .....	-	-	-	1	1
5510	Lockwasher 1/2" .....	-	-	-	1	1
7008	Nut 1/2-20 .....	-	-	-	1	1
203796	Steering post lighting switch control shaft assembly (50-23/32" long) (Prior to steering unit No. 901202) .	1	1	-	-	-
210892	Steering post lighting switch control shaft assembly (50-23/32" long) (After steering unit No. 901201) ....	-	1	1	-	-
216842	Steering post lighting switch control shaft assembly (51-23/32" long) .....	-	-	1	1	-
228951	Steering post lighting switch control shaft assembly ...	-	-	-	-	1
203788	Steering post lighting switch control shaft assembly retainer .....	2	2	2	2	2
210895	Steering post lighting switch control shaft anti-rattler (After steering unit No. 901201) .....	-	1	1	1	1
203790	Steering post lighting switch control shaft lever .....	-	1	1	1	1
228952	Steering post lighting switch control shaft lever .....	-	-	-	-	1
6178	Rivet 1/8 x 11/32" countersunk .....	-	1	1	1	1
6179	Rivet 1/8 x 11/32" round head .....	-	1	1	1	1
171196	Steering post lighting switch control shaft lever hub (Prior to steering unit No. 901202) .....	1	1	-	-	-
210879	Steering post lighting switch control shaft lever hub (After steering unit No. 901201) .....	-	1	1	1	1
171574	Steering post lighting switch control shaft spacer .....	1	1	-	-	-
203779	Steering post lighting switch control shaft lever spacer	-	1	1	1	1



## SERVICE PARTS LIST—PACKARD TWELVE

Steering Gear 185

Piece No.	Name	No. Required				
		905 906	1005 1006	1107 1108	1207 1208	1407 1408
171574	Steering post lighting switch control shaft spacer (Prior to steering unit No. 901202) .....	-	1	-	-	-
210882	Steering post lighting switch control shaft spacer (After steering unit No. 901201) .....	-	1	1	1	1
223370	Steering post oil seal .....	-	-	-	1	1
207980	Steering post throttle control gear .....	-	1	1	1	1
207982	Steering post throttle control gear friction disc .....	-	1	1	1	1
207983	Steering post throttle control gear friction disc retainer .....	-	1	1	1	1
207984	Steering post throttle control gear friction spring ....	-	1	1	1	1
207981	Steering post throttle control gear shaft .....	-	1	1	1	1
203795	Steering post throttle control shaft assembly (49-7/16" long) (Prior to steering unit No. 901202) .....	-	1	-	-	-
210889	Steering post throttle control shaft assembly (49-5/8" long) (After steering unit No. 901201) .....	-	1	1	-	-
216843	Steering post throttle control shaft assembly (50-5/8" long) .....	-	-	1	1	-
228958	Steering post throttle control shaft assembly .....	-	-	-	-	1
132167	Steering post throttle control shaft anti-rattler (Prior to steering unit No. 901202) .....	-	1	-	-	-
210887	Steering post throttle control shaft anti-rattler-lower (After steering unit No. 901201) .....	-	1	1	1	1
210888	Steering post throttle control shaft anti-rattler-upper (After steering unit No. 901201) .....	-	1	1	1	1
203790	Steering post throttle control shaft lever .....	-	1	1	1	-
228952	Steering post throttle control shaft lever .....	-	-	-	-	1
6179	Rivet 1/8 x 11/32" round head .....	-	2	2	2	2
171198	Steering post throttle control shaft lever hub (Prior to steering unit No. 901202) .....	-	1	-	-	-
210880	Steering post throttle control shaft lever hub (After steering unit No. 901201) .....	-	1	1	1	1
203779	Steering post throttle control shaft lever spacer .....	-	1	1	1	1
132148	Steering post throttle control shaft pinion .....	-	1	1	1	1
5815	Screw No. 10-32 x 7/8" fill. head .....	-	1	1	1	1
5500	Lockwasher No. 10 .....	-	1	1	1	1
7003	Nut No. 10-32 .....	-	1	1	1	1
210893	Steering post throttle control shaft spacer (After steering unit No. 901201) .....	-	1	1	1	1
171570	Steering post throttle control shaft spacer (Prior to steering unit No. 901202) .....	-	1	-	-	-
213173	Steering post throttling connecting rod link-right (Used only with clutch control) .....	-	1	-	-	-
209024	Steering post throttling connecting rod link (Not used with clutch control) .....	-	1	1	1	1
213172	Steering post throttling connecting rod link-left (Used only with clutch control) .....	-	1	-	-	-
209035	Yoke end pin (Not used with clutch control) .....	-	2	2	1	1
221438	Yoke end pin .....	-	-	-	1	1
5292	Yoke end pin (Used only with clutch control) .....	-	1	-	-	-
190192	Spring washer .....	-	2	2	1	1
3866	Washer 3/16" (Used only with clutch control) .....	-	1	-	-	-
4690	Cotter pin (Not used with clutch control) .....	-	2	2	2	-
4282	Cotter pin 1/16 x 3/4" .....	-	-	-	-	2
4280	Cotter pin (Used only with clutch control) .....	-	1	-	-	-
209058	Steering post throttling connecting rod (Not used with clutch control) .....	-	1	-	-	-
215108	Steering post throttling connecting rod (Not used with clutch control) .....	-	-	1	-	-
210804	Steering post throttling connecting rod (Used only with clutch control) .....	-	1	-	-	-

Piece No.	Name	No. Required				
		905 906	1005 1006	1107 1108	1207 1208	1407 1408
225693	Steering post throttling connecting rod .....	-	-	-	1	1
210097	Ball joint .....	-	1	1	1	1
7003	Nut No. 10-32 .....	-	2	2	2	2
5500	Lockwasher .....	-	1	1	1	1
191255	Steering post to toe board grommet .....	1	-	-	-	-
207102	Steering post to toe board grommet .....	-	1	1	1	1
213325	Steering post upper end nut .....	1	1	-	-	-
127012	Steering post upper end nut .....	-	-	1	1	1
203781	Steering wheel assembly .....	1	1	1	1	1
209747	Key .....	1	1	1	1	1
213437	Steering worm bearing assembly .....	2	2	-	-	-
216372	Steering worm bearing assembly .....	-	-	2	2	2
213320	Steering worm bearing adjusting sleeve assembly .....	1	1	-	-	-
215497	Steering worm bearing adjusting sleeve assembly .....	-	-	1	1	1
213322	Steering worm bearing adjusting sleeve adjusting screw .	1	1	-	-	-
5512	Lockwasher .....	1	1	-	-	-
213316	Locknut .....	1	1	-	-	-
213317	Steering worm and post assembly 46-7/16" long .....	1	1	-	-	-
215880	Steering worm and post assembly 46-7/16" long .....	-	-	1	-	-
219023	Steering worm and post assembly 47-7/16" long .....	-	-	1	1	1
209781	Steering worm sector and shaft lever (8" long from center to center) .....	1	-	-	-	-
209926	Steering worm sector and shaft lever (7-1/2" long from center to center) .....	1	-	-	-	-
209504	Steering worm sector and shaft lever .....	-	1	-	-	-
197145	Ball joint .....	1	1	-	-	-
7109	Nut 8/17-18 castle .....	1	1	-	-	-
4305	Cotter pin 1/8 x 7/8" .....	1	1	-	-	-
114211	Steering worm sector and shaft lever ball joint cup washer .....	2	2	-	-	-
114316	Plain washer .....	1	1	-	-	-
210196	Steering worm sector and shaft oil seal .....	1	1	-	-	-
210197	Steering worm sector and shaft oil seal retainer .....	1	1	-	-	-

## TOE BOARD

207397	Toe board assembly .....	-	1	1	-	-
223187	Toe board assembly .....	-	-	-	1	1
203123	Toe board .....	1	-	-	-	-
5471	Screw 1/4-28 x 3/4" hex. hd. ....	5	-	-	-	-
5916	Screw No. 10-32 x 1-1/2" flat hd. ....	2	-	-	-	-
5251	Screw 1/4-28 x 1" fill. head .....	-	2	2	-	-
7827	Screw 1/4-28 x 3/4" hex. hd. ....	-	5	5	-	-
5315	Screw (Top) 1/4-28 x 1-3/8" hex. hd. ....	-	-	-	5	5
5447	Lockwasher 1/4" Shakeproof .....	-	-	-	-	5
5251	Screw (Side) 1/4-28 x 1" fill. head .....	-	-	-	2	2
5502	Lockwasher 1/4" .....	-	2	2	7	2
185832	Washer .....	2	-	-	-	-
3867	Washer 5/16" .....	2	-	-	-	-
5500	Lockwasher No. 10 .....	2	-	-	-	-
7003	Nut No. 10-32 plain .....	2	-	-	-	-
202836	Toe board accelerator pedal foot rest assembly .....	1	1	1	1	1
7721	Screw No. 10-32 x 1" fill. head .....	2	-	-	-	-
5486	Screw No. 10-32 x 1-1/8" fill. head .....	-	-	-	2	2
7729	Screw No. 10-32 x 11/32" fill. head .....	-	2	2	-	-
5500	Lockwasher 3/16" .....	2	2	2	2	2
3866	Washer 3/16" .....	2	-	2	2	2
7003	Nut No. 10-32 .....	2	2	2	2	2

## SERVICE PARTS LIST—PACKARD TWELVE

Tool 187

Part No.	Name	No. Required				
		905 906	1005 1006	1107 1108	1207 1208	1407 1408
202835	Toe board accelerator pedal foot rest pad .....	1	1	1	1	1
202834	Toe board accelerator pedal foot rest pad retainer .....	1	1	1	1	1
203122	Toe board change speed lever support liner .....	1	-	-	-	-
210371	Toe board change speed lever support liner .....	-	1	1	-	-
221405	Toe board change speed lever support liner .....	-	-	-	1	1
202996	Toe board change speed lever support liner plate asb. ..	1	-	-	-	-
207423	Toe board change speed lever support liner plate asb. ..	-	1	1	-	-
221406	Toe board change speed lever support liner plate .....	-	-	-	1	1
132776	Rivet No. 2132 x 11/32 flat head tubular .....	-	-	-	7	7
191247	Toe board change speed lever support liner plate screw .	5	-	-	-	-
197426	Toe board change speed lever support liner plate screw .	-	6	6	-	-
213468	Toe board clutch pedal spring .....	-	1	1	-	-
5485	Bolt 1/4-28 x 5/8" carriage .....	-	1	1	-	-
7004	Nut 1/4-28 .....	-	1	1	-	-
5502	Lockwasher 1/4" .....	-	1	1	-	-
3877	Washer .....	-	1	1	-	-
209486	Toe board clutch pedal spring pad .....	-	1	1	-	-
5995	Rivet 9/64 x 5/16" oval head tubular .....	-	1	-	-	-
48317	Rivet 9/64 x 5/16" oval head tubular .....	-	-	1	-	-
203143	Toe board insulation liners assembly .....	1	-	-	-	-
207437	Toe board insulation liners assembly .....	-	1	1	-	-
207432	Toe board insulation .....	-	1	1	-	-
223198	Toe board insulation .....	-	-	-	1	1
203144	Toe board insulation .....	1	-	-	-	-
6252	Rivet 3/16 x 1 oval head .....	-	-	-	8	8
3867	Washer 3/16" special .....	-	-	-	8	8
203132	Toe board liner (side) .....	2	-	-	-	-
207415	Toe board liner (side) .....	-	2	2	-	-
221629	Toe board liner (side) .....	-	-	-	2	2
48317	Rivet No. 24 - 9/64 x 9/32" .....	-	2	8	8	8
140855	Rivet 5/32 x 9/16" No. 272 oval head split .....	6	-	-	-	-
191646	Toe board pedal hole bumper .....	2	-	-	-	-
205954	Toe board pedal hole bumper .....	-	2	2	2	2
190129	Toe board pedal hole dust cover .....	2	-	-	-	-
205953	Toe board pedal hole dust cover .....	-	2	2	2	2

## TOOLS

190681	Tool roll .....	1	1	1	1	1
203732	Tool roll-equipped .....	1	1	1	1	1
213029	Tool box auto-jack and handle assembly .....	1	1	1	1	1
159714	Tool box auto-jack handle (Supersedes 186166) .....	1	1	1	1	1
128287	Tool box hammer .....	1	1	1	1	1
194299	Tool box jack container .....	1	1	1	1	1
194298	Tool box jack handle and wheel wrench container .....	1	1	1	1	1
128288	Tool box monkey wrench .....	1	1	1	1	1
205201	Tool box motor starting crank assembly .....	1	-	-	-	-
210212	Tool box motor starting crank assembly .....	-	1	1	-	-
128289	Tool box pliers .....	1	1	1	1	1
71030	Tool box punch .....	1	1	1	1	1
128290	Tool box screw driver (3" blade) .....	1	1	1	1	1
128291	Tool box screw driver (6" blade) .....	1	1	1	1	1
203665	Tool box spark plug wrench .....	1	1	1	1	1
121535	Tool box tire pump .....	1	1	-	-	-
210404	Tool box tire pump .....	-	1	1	-	-
47669	Tool box wrench 15 degrees double head (1/4 and 5/16" openings) .....	1	1	1	1	1
46707	Tool box wrench 15 degrees double head (7/16 and 1/2" openings) .....	1	1	1	1	1

Piece No.	Name	No. Required				
		905 906	1005 1006	1107 1108	1207 1208	1407 1408
46706	Tool box wrench 15 degrees double head (9/16 and 5/8" openings) .....	1	1	1	1	1
115773	Tool box wrench 15 degrees single head (9/16" openings-special) .....	1	1	1	1	1
115774	Tool box wrench 15 degrees double head (3/4 and 13/16" openings) .....	1	1	1	1	1
225804	Tool box wheel and jack wrench (Supersedes 186165) .....	1	1	1	1	-
61577	Wheel puller bolt .....	1	1	1	-	-
115781	Wheel puller shell .....	1	-	-	-	-
213814	Wheel puller shell .....	-	1	1	-	-

### TOOL BOX

190773	Tool box assembly .....	1	-	-	-	-
7827	Tool box to bonnet ledge bolt 1/4-28 x 3/4" hex. hd. ...	2	-	-	-	-
5502	Lockwasher 1/4" .....	2	-	-	-	-
7004	Nut 1/4-28 .....	2	-	-	-	-
62065	Washer 17/64 x 3/4" plain .....	2	-	-	-	-
190736	Tool box cover assembly .....	1	-	-	-	-
191416	Tool box cover cushion .....	1	-	-	-	-
3868	Tool box cover cushion retainer washer 3/16" .....	14	-	-	-	-
7003	Nut No. 10-32 .....	14	-	-	-	-
194083	Tool box cover and finishing plate assembly .....	1	-	-	-	-
191895	Tool box cover finishing plate .....	1	-	-	-	-
186982	Tool box cover lock cylinder assembly .....	1	-	-	-	-
194883	Tool box cover lock bolt .....	1	-	-	-	-
194884	Tool box cover lock bolt spacer .....	1	-	-	-	-
194885	Screw .....	1	-	-	-	-
7003	Nut No. 10-32 .....	1	-	-	-	-
5500	Lockwasher No. 10 .....	1	-	-	-	-
190719	Tool box cover lock bolt bracket screw .....	1	-	-	-	-
7004	Nut 1/4-28 .....	1	-	-	-	-
5502	Lockwasher 1/4" .....	1	-	-	-	-
190706	Tool box cover lock bolt spring .....	1	-	-	-	-
190721	Tool box cover lock bolt striker plate .....	1	-	-	-	-
186981	Tool box cover lock cylinder plate .....	1	-	-	-	-
190305	Tool box cover lock cylinder plate to cylinder screw No. 4-40 x 3/16" F.H. ....	1	-	-	-	-
190157	Tool box cover spring .....	1	-	-	-	-
186983	Tool box cover spring rivet .....	2	-	-	-	-
7827	Tool box to fender bolt 1/4-28 x 3/4" hex. hd. ....	9	-	-	-	-
5502	Lockwasher 1/4" .....	9	-	-	-	-
7004	Nut 1/4-28 .....	9	-	-	-	-
62065	Washer 17/64 x 3/4" plain special .....	10	-	-	-	-
194846	Washer .....	8	-	-	-	-
194847	Tool box to fender bolt washer gasket .....	10	-	-	-	-
5770	Tool box to fender screw 1/4-28 x 7/8" O.H. (Side wheel carrier) .....	2	-	-	-	-
190756	Tool box to frame bracket .....	1	-	-	-	-
5449	Screw 5/16-24 x 3/4" hex. hd. ....	4	-	-	-	-
3909	Washer 5/16" special .....	2	-	-	-	-
5504	Lockwasher 5/16" .....	4	-	-	-	-
7005	Nut 5/16-24 .....	4	-	-	-	-
190805	Tool box liner .....	1	-	-	-	-

Piece No.	Name	No. Required				
		905 906	1005 1006	1107 1108	1207 1208	1407 1408
<b>TRANSMISSION</b>						
196600	Transmission assembly .....	1	-	-	-	-
205865	Transmission assembly .....	-	1	-	-	-
215084	Transmission assembly .....	-	-	1	1	1
215371	Transmission backing light switch .....	-	-	1	1	1
157696	Transmission backing light switch cable clip .....	-	-	1	1	1
216946	Transmission case and plug assembly .....	-	-	1	1	1
201344	Transmission case and plug assembly .....	1	-	-	-	-
213810	Transmission case and plug assembly .....	-	1	-	-	-
196517	Transmission case cover assembly .....	1	1	1	-	-
225107	Transmission case cover .....	-	-	-	1	1
7826	Screw 5/16-24 x 5/8" hex. hd. ....	8	8	8	8	8
5504	Lockwasher 5/16" std. ....	8	8	8	8	8
196547	Transmission case cover gasket .....	1	1	1	1	1
176848	Transmission case cover liner .....	1	1	1	-	-
176849	Transmission case cover reinforcement .....	1	1	1	-	-
4146	Rivet 1/8 x 3/8" .....	6	6	6	-	-
219932	Transmission case inspection hole cover assembly (Supersedes 207554) .....	-	1	1	1	1
196618	Transmission case inspection hole cover .....	1	-	-	-	-
5699	Screw 1/4-28 x 13/32" flat head .....	-	4	4	4	4
5396	Lockwasher 1/4" countersunk Shakeproof .....	-	4	4	4	4
7801	Screw 1/4-28 x 1/2" hex. hd. ....	4	-	-	-	-
5502	Lockwasher 1/4" .....	4	-	-	-	-
7006	Transmission case to motor retaining nut 3/8-24 plain ..	12	-	-	-	-
5506	Lockwasher 3/8" .....	12	-	-	-	-
6006	Transmission case motor support insulator bracket stud- short 3/8 .....	-	-	-	7	7
6106	Transmission case motor support insulator bracket stud- long 3/8 .....	-	-	-	1	1
107889	Transmission case oil hole plug .....	2	2	2	2	2
20075	Gasket 1-1/4" .....	2	2	2	2	2
216208	Transmission change speed lever .....	1	1	1	-	-
223555	Transmission change speed lever .....	-	-	-	1	1
186781	Transmission change speed lever anti-rattler spring ....	1	1	1	1	1
203155	Transmission change speed lever ball-upper .....	1	1	1	1	1
186778	Transmission change speed lever ball cover felt .....	1	1	1	1	1
196620	Transmission change speed lever cap .....	1	1	1	1	1
186779	Transmission change speed lever cap retaining screw No. 10-24 x 3/8" O.H. machine .....	3	3	3	3	3
186780	Transmission change speed lever pivot pin .....	1	1	1	1	1
196619	Transmission change speed lever support .....	1	1	1	1	1
219121	Transmission change speed lever support gasket .....	-	-	1	1	1
197542	Transmission change speed lever support spring .....	1	1	1	1	1
190984	Washer .....	1	1	1	1	1
4306	Cotter pin 1/8 x 1" .....	1	1	1	1	1
196548	Transmission clutch shaft assembly .....	1	-	-	-	-
210346	Transmission clutch shaft assembly .....	-	1	1	1	1
205784	Transmission clutch shaft bearing front spacer .....	1	1	1	1	1
196611-	Transmission clutch shaft bearing rear .....	1	1	1	1	1
196603	Transmission clutch shaft bearing rear cover .....	1	1	-	-	-
215101	Transmission clutch shaft bearing rear cover .....	-	-	1	1	1
196573	Gasket .....	1	1	1	1	1
6105	Stud 5/16" .....	8	7	7	7	7
6335	Stud 5/16" .....	-	1	1	1	1
5504	Lockwasher 5/16" .....	8	8	8	8	8
7005	Nut 5/16-24 .....	8	8	8	8	8
196604	Transmission clutch shaft bearing rear cover and oil extension assembly .....	1	1	-	-	-

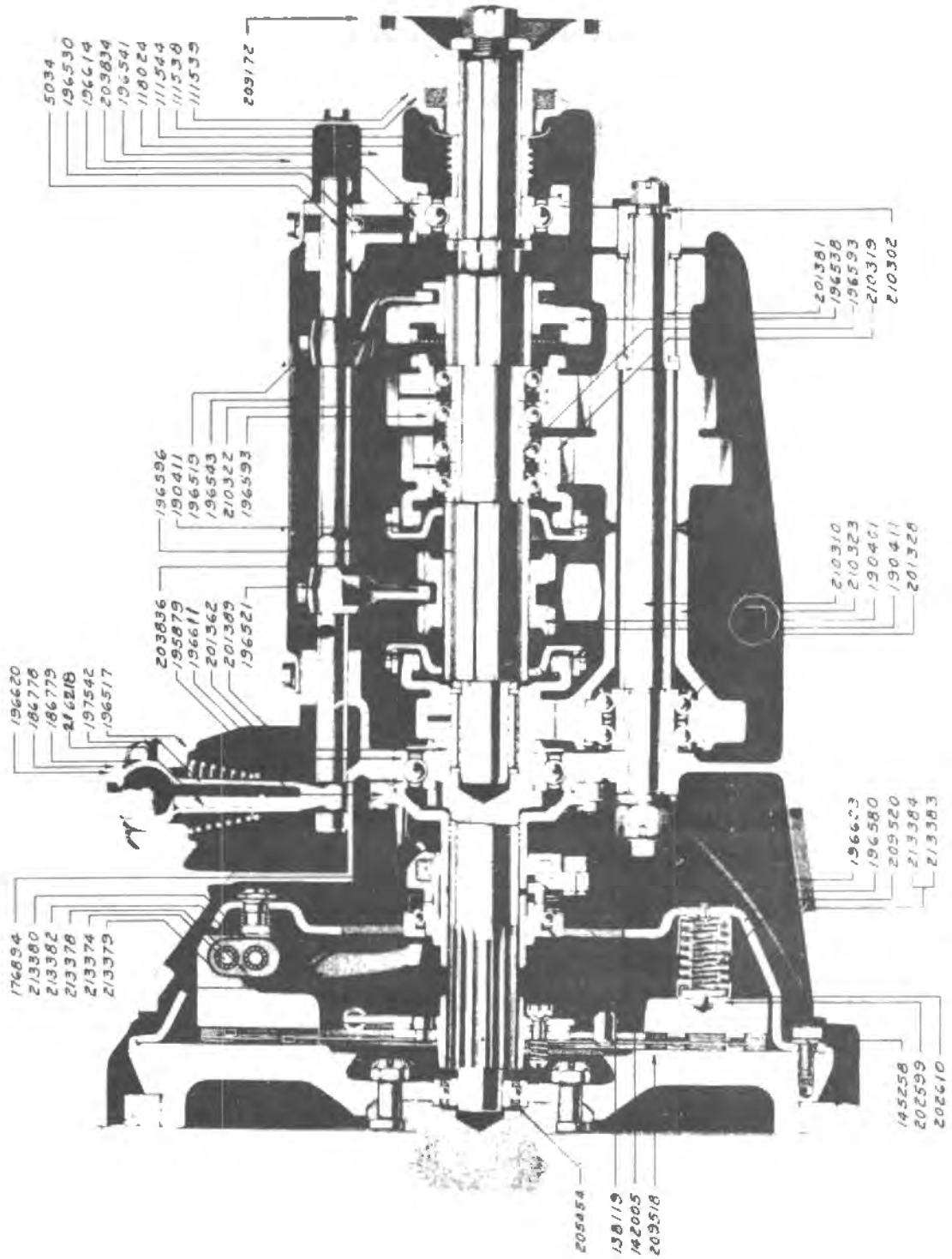

1005-1006

SERVICE PARTS LIST—PACKARD TWELVE

Transmission 191

Piece No.	Name	No. Required				
		905 906	1005 1006	1107 1108	1207 1208	1407 1408
201365	Transmission clutch shaft bearing rear oil thrower (.242 thick) .....	X	X	X	X	X
201358	Transmission clutch shaft bearing rear oil thrower (.228 thick) .....	X	X	X	X	X
201359	Transmission clutch shaft bearing rear oil thrower (.230 thick) .....	X	X	X	X	X
201360	Transmission clutch shaft bearing rear oil thrower (.232 thick) .....	X	X	X	X	X
201361	Transmission clutch shaft bearing rear oil thrower (.234 thick) .....	X	X	X	X	X
201362	Transmission clutch shaft bearing rear oil thrower (.236 thick) .....	X	X	X	X	X
201363	Transmission clutch shaft bearing rear oil thrower (.238 thick) .....	X	X	X	X	X
201364	Transmission clutch shaft bearing rear oil thrower (.240 thick) .....	X	X	X	X	X
201366	Transmission clutch shaft bearing rear oil thrower (.244 thick) .....	X	X	X	X	X
201367	Transmission clutch shaft bearing rear oil thrower (.246 thick) .....	X	X	X	X	X
201368	Transmission clutch shaft bearing rear oil thrower (.248 thick) .....	X	X	X	X	X
201369	Transmission clutch shaft bearing rear oil thrower (.250 thick) .....	X	X	X	X	X
201370	Transmission clutch shaft bearing rear oil thrower (.252 thick) .....	X	X	X	X	X
201371	Transmission clutch shaft bearing rear oil thrower (.254 thick) .....	X	X	X	X	X
201372	Transmission clutch shaft bearing rear oil thrower (.256 thick) .....	X	X	X	X	X
201354	Transmission clutch shaft bearing rear oil thrower (.220) .....	X	X	X	X	X
201355	Transmission clutch shaft bearing rear oil thrower (.222) .....	X	X	X	X	X
201356	Transmission clutch shaft bearing rear oil thrower (.224) .....	X	X	X	X	X
201357	Transmission clutch shaft bearing rear oil thrower (.226) .....	X	X	X	X	X
196675	Transmission clutch shaft bearing rear retaining ring (.086) .....	X	X	X	X	X
196676	Transmission clutch shaft bearing rear retaining ring (.088) .....	X	X	X	X	X
196677	Transmission clutch shaft bearing rear retaining ring (.090) .....	X	X	X	X	X
196681	Transmission clutch shaft bearing rear retaining ring (.092) .....	X	X	X	X	X
196612	Transmission clutch shaft bearing rear retaining ring (.094) .....	X	X	X	X	X
196680	Transmission clutch shaft bearing rear retaining ring (.096) .....	X	X	X	X	X
196679	Transmission clutch shaft bearing rear retaining ring (.098) .....	X	X	X	X	X
196678	Transmission clutch shaft bearing rear retaining ring (.100) .....	X	X	X	X	X
195879	Transmission clutch shaft bearing retaining nut (Left hand thread) .....	1	1	1	1	1
196605	Transmission clutch shifter lever .....	1	-	-	1	1
209194	Transmission clutch shifter lever .....	-	1	1	-	-
196610	Transmission clutch shifter lever spring .....	1	1	1	1	1



Piece No.	Name	No. Required				
		905 906	1005 1006	1107 1108	1207 1208	1407 1408
190245	Transmission clutch shifter lever spring retainer .....	1	1	1	1	1
4310	Cotter pin 1/8 x 1-1/2" .....	1	1	1	1	1
209196	Transmission clutch shifter lever trunnion ball .....	-	2	2	-	-
209197	Transmission clutch shifter lever trunnion oil seal ....	-	1	1	-	-
209198	Transmission clutch shifter lever trunnion oil seal retainer .....	-	1	1	-	-
209199	Transmission clutch shifter lever trunnion pin .....	-	1	1	-	-
209200	Transmission clutch shifter lever trunnion retainer ....	-	1	1	-	-
209201	Transmission clutch shifter lever trunnion roller .....	-	18	18	-	-
230328	Transmission clutch shifter thrust bearing (Supersedes 215038) .....	1	1	1	1	1
225188	Transmission clutch shifter thrust bearing lubricator drip plug adapter .....	-	-	-	1	1
6048	Lockwasher 3/8" Shakeproof .....	-	-	-	1	1
215061	Transmission clutch shifter thrust bearing lubricator tube (Supersedes 215041) .....	-	-	1	1	1
196617	Transmission clutch shifter thrust bearing sleeve asb. .	1	-	-	-	-
215040	Transmission clutch shifter thrust bearing sleeve asb. .	-	-	1	1	1
196580	Transmission clutch shifter thrust bearing sleeve asb. .	-	1	-	-	-
142005	Transmission clutch shifter thrust bearing sleeve collar filler .....	1	1	-	-	-
176894	Transmission clutch shifter thrust bearing sleeve collar oil extension .....	1	1	-	-	-
144891	Transmission clutch shifter thrust bearing sleeve collar spring .....	2	2	2	2	2
5397	Rivet 1/8 x 5/8" countersunk head .....	2	2	2	2	2
203832	Transmission clutch vacuum cylinder bleeder valve body assembly .....	1	1	-	-	-
7706	Screw No. 10-32 x 1/2" fill. head .....	2	2	-	-	-
5500	Lockwasher No. 10 .....	2	2	-	-	-
7003	Nut No. 10-32 .....	2	2	-	-	-
203838	Transmission clutch vacuum cylinder bleeder valve body gasket .....	1	1	-	-	-
203837	Transmission clutch vacuum cylinder bleeder valve piston	1	1	-	-	-
201324	Transmission countershaft .....	1	-	-	-	-
210310	Transmission countershaft .....	-	1	1	1	1
201381	Transmission countershaft bearing rear .....	1	1	1	1	1
201328	Transmission countershaft bearing front .....	1	1	1	1	-
201329	Transmission countershaft bearing front retaining ring (.0937) .....	x	x	x	x	x
201330	Transmission countershaft bearing front retaining ring (.0947) .....	x	x	x	x	x
201331	Transmission countershaft bearing front retaining ring (.0957) .....	x	x	x	x	x
201332	Transmission countershaft bearing front retaining ring (.0967) .....	x	x	x	x	x
201353	Transmission countershaft bearing rear spacer .....	1	1	1	1	1
201325	Transmission countershaft bushing .....	1	-	-	-	-
210302	Transmission countershaft bushing .....	-	1	1	1	1
201326	Transmission countershaft bushing gasket .....	1	-	-	-	-
210334	Transmission countershaft bushing gasket .....	-	1	1	1	1
201347	Transmission countershaft gear cluster .....	1	-	-	-	-
210323	Transmission countershaft gear cluster .....	-	1	1	1	1
210305	Transmission countershaft lock .....	-	x	x	x	x
210306	Transmission countershaft lock .....	-	x	x	x	x
210307	Transmission countershaft lock .....	-	x	x	x	x
210308	Transmission countershaft lock .....	-	x	x	x	x
127273	Transmission countershaft nut front .....	1	1	1	1	1
4320	Cotter pin 5/32 x 1-1/8" .....	1	1	1	1	1
201317	Washer special .....	1	1	1	1	1



Piece No.	Name	No. Required				
		905 906	1005 1006	1107 1108	1207 1208	1407 1408
7108	Transmission countershaft nut rear 1/2-20 .....	1	1	1	1	1
4291	Cotter pin 3/32 x 3/4" .....	1	1	1	1	1
196521	Transmission direct drive and 2nd speed gear shifter fork .....	1	1	1	1	1
5762	Screw 5/16-24 x 1-3/8" hex. hd. ....	1	1	1	1	1
5504	Lockwasher 5/16" .....	1	1	1	1	1
196545	Transmission direct drive and 2nd speed shifter fork shaft (Use without bleeder valve) .....	1	-	-	-	-
203836	Transmission direct drive and 2nd speed shifter fork shaft (Use with bleeder valve) .....	1	1	-	-	-
216847	Transmission direct drive and 2nd speed shifter fork shaft .....	-	-	1	1	1
196596	Transmission driving shaft .....	1	1	1	1	1
4320	Cotter pin 5/32 x 1-1/8" .....	1	1	1	-	-
127273	Nut special .....	1	1	1	-	-
140079	Washer special .....	1	1	1	-	-
201389	Transmission driving shaft bearing front .....	1	1	1	1	1
176863	Transmission driving shaft bearing front spacer .....	1	1	1	1	1
196614	Transmission driving shaft bearing rear .....	1	1	1	1	1
196541	Transmission driving shaft bearing rear cover .....	1	1	1	1	1
196516	Transmission driving shaft bearing rear cover gasket ...	1	1	1	1	1
196551	Stud .....	4	4	4	4	4
5506	Lockwasher 3/8" .....	4	4	4	4	4
7006	Nut 3/8-24 .....	4	4	4	4	4
111538	Transmission driving shaft bearing rear dust washer ....	1	1	1	1	1
111539	Transmission driving shaft bearing rear dust washer retainer .....	1	1	1	1	1
111544	Transmission driving shaft bearing rear oil thrower ....	1	1	1	1	1
196682	Transmission driving shaft bearing rear retaining ring (.086) .....	x	x	x	x	x
196683	Transmission driving shaft bearing rear retaining ring (.088) .....	x	x	x	x	x
196684	Transmission driving shaft bearing rear retaining ring (.090) .....	x	x	x	x	x
196685	Transmission driving shaft bearing rear retaining ring (.092) .....	x	x	x	x	x
196615	Transmission driving shaft bearing rear retaining ring (.094) .....	x	x	x	x	x
196686	Transmission driving shaft bearing rear retaining ring (.096) .....	x	x	x	x	x
196687	Transmission driving shaft bearing rear retaining ring (.098) .....	x	x	x	x	x
196688	Transmission driving shaft bearing rear retaining ring (.100) .....	x	x	x	x	x
191513	Transmission driving shaft bearing rear spacer (.0725) .	x	x	x	x	x
191514	Transmission driving shaft bearing rear spacer (.0745) .	x	x	x	x	x
191515	Transmission driving shaft bearing rear spacer (.0765) .	x	x	x	x	x
191516	Transmission driving shaft bearing rear spacer (.0785) .	x	x	x	x	x
196582	Transmission driving shaft bearing rear spacer (.0805) .	x	x	x	x	x
196583	Transmission driving shaft bearing rear spacer (.0825) .	x	x	x	x	x
196584	Transmission driving shaft bearing rear spacer (.0845) .	x	x	x	x	x
196585	Transmission driving shaft bearing rear spacer (.0865) .	x	x	x	x	x
196586	Transmission driving shaft bearing rear spacer (.0885) .	x	x	x	x	x
196587	Transmission driving shaft bearing rear spacer (.0905) .	x	x	x	x	x
196588	Transmission driving shaft bearing rear spacer (.0925) .	x	x	x	x	x
196589	Transmission driving shaft bearing rear spacer (.0945) .	x	x	x	x	x
196590	Transmission driving shaft bearing rear spacer (.0965) .	x	x	x	x	x
196689	Transmission driving shaft bearing rear spacer (.0985) .	x	x	x	x	x
196690	Transmission driving shaft bearing rear spacer (.1005) .	x	x	x	x	x
196691	Transmission driving shaft bearing rear spacer (.1025) .	x	x	x	x	x

SERVICE PARTS LIST—PACKARD TWELVE

Transmission 193

Piece No.	Name	No. Required				
		905 906	1005 1006	1107 1108	1207 1208	1407 1408
196692	Transmission driving shaft bearing rear spacer (.1045) .	x	x	x	x	x
196693	Transmission driving shaft bearing rear spacer (.1065) .	x	x	x	x	x
196694	Transmission driving shaft bearing rear spacer (.1085) .	x	x	x	x	x
196695	Transmission driving shaft bearing rear spacer (.1105) .	x	x	x	x	x
190401	Transmission driving shaft direct drive and 2nd speed clutch gear .....	1	1	1	1	1
201348	Transmission driving shaft first speed gear .....	1	-	-	-	-
210322	Transmission driving shaft first speed gear .....	-	1	1	1	1
196593	Transmission driving shaft first speed gear bearing ....	2	2	2	2	2
196592	Spacer .1875 .....	x	x	x	x	x
201373	Spacer .1885 .....	x	x	x	x	x
201374	Spacer .1895 .....	x	x	x	x	x
196538	Transmission driving shaft first speed and reverse clutch gear .....	1	1	1	1	x
196597	Transmission driving shaft second speed gear .....	1	-	-	-	-
210319	Transmission driving shaft second speed gear .....	-	1	1	1	x
196593	Transmission driving shaft second speed gear bearing ...	2	2	2	2	2
196592	Spacer .1875 .....	x	x	x	x	x
201373	Spacer .1885 .....	x	x	x	x	x
201374	Spacer .1895 .....	x	x	x	x	x
196623	Transmission driving shaft second and first speed gear bearing spacer .....	1	1	1	1	1
196591	Transmission driving shaft and second speed gear bearing spacer .....	1	1	1	1	1
196595	Transmission driving shaft sleeve .....	1	1	1	1	1
196581	Transmission driving shaft universal joint flange (Prior to frame No. 901372 for 1005 and 901381 for 1006) ....	1	1	-	-	-
209172	Transmission driving shaft universal joint flange (Square flange) (After frame No. 901371 for 1005 and 901380 for 1006) .....	-	1	1	-	-
219208	Transmission driving shaft universal joint flange (Round flange) .....	-	-	1	1	1
196519	Transmission first speed and reverse gear shifter fork .	1	1	1	1	1
5762	Screw 5/16-24 x 1-3/8" hex. hd. ....	1	1	1	1	1
5504	Lockwasher 5/16" .....	1	1	1	1	1
196543	Transmission first speed and reverse gear shifter fork shaft .....	1	1	1	1	1
5761	Transmission gear shifter shaft interlocking ball .....	1	1	1	1	1
196557	Transmission gear shifter shaft stop cover (Use without bleeder valve) .....	1	1	-	-	-
203834	Transmission gear shifter shaft stop cover (Use with bleeder valve) .....	1	1	-	-	-
215139	Transmission gear shifter shaft stop cover (Use with bleeder valve) .....	-	-	1	1	1
196558	Gasket .....	1	1	1	1	1
196527	Screw 5/16-24 x 2-5/16" machine .....	2	2	2	2	2
5504	Lockwasher 5/16" .....	2	2	2	2	2
196520	Transmission reversing pinion .....	1	1	1	1	1
196552	Transmission reversing pinion bushing .....	1	1	1	1	1
196556	Transmission reversing pinion pin .....	1	1	1	1	1
196526	Transmission reversing pinion pin lock screw .....	1	1	1	1	1
179531	Gasket .....	1	1	1	1	1
5034	Transmission shifter fork shaft lock ball 3/8" diameter.	2	2	2	2	2
103871	Transmission shifter fork shaft lock expansion plug 9/16" .....	1	1	1	1	1
196530	Transmission shifter fork shaft lock ball spring .....	2	2	2	2	2
184571	Transmission speedometer pinion and shaft (5.07 to 1 ratio) (25 teeth) .....	1	1	1	-	-
175442	Transmission speedometer pinion and shaft (4.69 to 1 ratio) (23 teeth) .....	1	-	-	-	-

Piece No.	Name	No. Required				
		905 906	1005 1006	1107 1108	1207 1208	1407 1408
148440	Transmission speedometer pinion and shaft (4.41 to 1 ratio) (21 teeth) .....	1	-	-	-	-
118970	Transmission speedometer pinion and shaft (4.41 to 1 ratio) (22 teeth) .....	-	1	1	1	1
121791	Transmission speedometer pinion and shaft (4.06 to 1 ratio) (20 teeth) .....	1	1	-	-	-
137102	Transmission speedometer pinion and shaft (4.69 to 1 ratio) (24 teeth) .....	-	1	1	1	1
148440	Transmission speedometer pinion and shaft (4.06 to 1 ratio) (21 teeth) .....	-	1	1	1	1
5321	Key Whitney No. 10 (Woodruff system) .....	1	1	1	1	1
184497	Transmission speedometer driven pinion shaft bearing (5.07 to 1 ratio) .....	1	1	1	-	-
175441	Transmission speedometer driven pinion shaft bearing (4.69 to 1 ratio) .....	1	1	-	-	-
158147	Transmission speedometer driven pinion shaft bearing (4.41 to 1 ratio) .....	1	-	-	-	-
158146	Transmission speedometer driven pinion shaft bearing (4.41 to 1 ratio) .....	-	1	1	1	1
170722	Transmission speedometer driven pinion shaft bearing (4.06 to 1 ratio) .....	1	-	-	-	-
158147	Transmission speedometer pinion shaft bearing (4.06 to 1 ratio) .....	-	1	1	1	1
158145	Transmission speedometer driven pinion shaft bearing (4.69 to 1 ratio) .....	-	1	1	1	1
137108	Transmission speedometer driven pinion shaft bearing gasket .....	1	1	1	1	1
7827	Transmission speedometer driven pinion shaft bearing screw 1/4-28 x 3/4" hex. hd. ....	2	2	2	2	2
5502	Lockwasher 1/4" .....	2	2	2	2	2
118024	Transmission speedometer driving gear .....	1	1	1	1	1
96529	Transmission speedometer driving shaft screw .....	1	1	1	1	1
190411	Transmission synchronizer brake and housing assembly ...	2	2	2	2	2
190441	Transmission synchronizer connecting link .....	2	2	2	2	2
196540	Transmission synchronizer operating yoke .....	1	1	1	1	1
186838	Transmission synchronizer operating yoke pin .....	2	2	2	2	2
191507	Transmission synchronizer operating yoke pin retaining ring .....	2	2	2	2	2
190423	Transmission synchronizer operating yoke pivot pin ....	2	2	2	2	2
186625	Transmission synchronizer plunger assembly .....	2	2	2	2	2
186611	Transmission synchronizer yoke centralizing spring ....	2	2	2	2	2
186615	Transmission synchronizer yoke centralizing spring cap .	2	2	2	2	2
4284	Cotter pin 3/32 x 1-1/8" .....	2	2	2	2	2
196621	Transmission synchronizer yoke centralizing spring screw .....	1	1	1	1	1
5508	Lockwasher 7/16" .....	1	1	1	1	1
191562	Transmission synchronizer yoke pivot pin packing .....	2	2	2	2	2
191561	Transmission synchronizer yoke pivot pin packing housing	2	2	2	2	2
191505	Transmission synchronizer yoke pivot pin retaining clip.	2	2	2	2	2
5687	Screw 1/4-28 x 5/8" fill. head .....	2	2	2	2	2
5502	Lockwasher 1/4" .....	2	2	2	2	2

## TRUNK RACK

216816	Trunk rack assembly (Used on bodies 731-2-3-8-9-41-43) .	-	-	1	-	-
205161	Trunk rack assembly (Used on bodies 574-5-6-7-570-630-4-5-6-7-647) .....	1	1	-	-	-
216812	Trunk rack assembly (Used on 730-4-5-6-7-747-D858-D859).	-	-	1	-	-



191404



191403

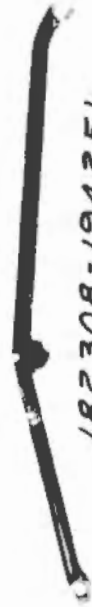

182308-194251



215574-215573-205613  
205614-205616-205615

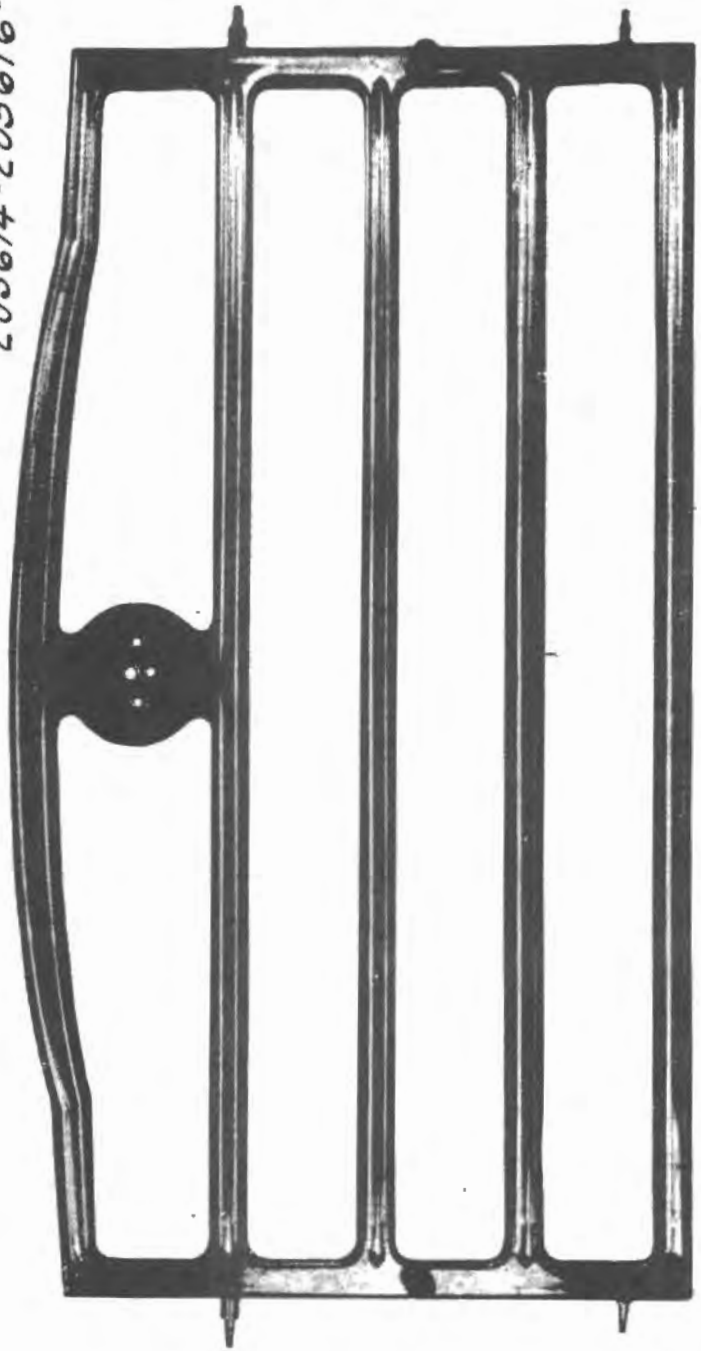

144770  
194250  
144782



184998

210311-205162-205161

Piece No.	Name	No. Required				
		905 906	1005 1006	1107 1108	1207 1208	1407 1408
205162	Trunk rack assembly (Used on bodies 571-3-8-9-581-583-631-3-8-9-641-3-5633-5633-A) .....	1	1	-	-	-
144770	Pivot pin-short .....	2	2	2	-	-
144782	Pivot pin-long (Used on bodies 570-4-5-6-7-630-4-5-6-7-647) .....	2	2	-	-	-
194250	Trunk rack pivot pin-long (Used on bodies 571-3-8-9-581-583-631-3-8-9-641-3-5633-5633-A) .....	2	2	2	-	-
5665	Blind nut 5/16-24 .....	4	4	4	-	-
5504	Lockwasher 5/16" .....	4	4	4	-	-
3874	Washer 5/16" .....	4	4	4	-	-
182308	Trunk rack brace joint assembly (Used on bodies 570-4-5-6-7-630-4-5-6-7-647-730-4-5-6-7-47-D858-D859) .....	2	2	2	-	-
194251	Trunk rack brace joint assembly (Used on bodies 571-3-8-9-581-583-631-3-8-9-641-3-5633-5633-A-731-2-3-8-9-41-43) .....	2	2	2	-	-
203166	Trunk rack emblem .....	1	1	1	-	-
5447	Lockwasher .....	1	1	1	-	-
205686	Trunk rack and trunk rack frame bracket assembly (Used on bodies 570-4-5-6-7-630-4-5-6-7-647) .....	1	1	-	-	-
215658	Trunk rack and trunk rack frame bracket assembly (Used on 730-4-5-6-7-47-D858-D859) .....	-	-	1	-	-
205685	Trunk rack and trunk rack frame bracket assembly (Used on bodies 571-3-8-9-581-583-631-3-8-9-641-3-5633-5633-A-731-2-3-8-9-41-43) .....	1	1	1	-	-
5394	Trunk rack frame bracket bolt (Screw 3/8-24 x 1-1/2" hex. hd.) .....	2	2	2	-	-
7006	Nut 3/8-24 .....	2	2	-	-	-
6350	Nut 3/8-24 blind .....	-	-	2	-	-
5506	Lockwasher 3/8" .....	2	2	2	-	-
201782	Trunk rack frame bracket bolt frame reinforcement plate. ....	2	2	2	-	-
205613	Trunk rack frame bracket assembly left .....	1	1	-	-	-
215574	Trunk rack frame bracket assembly left (Used on bodies 730-734-5-6-737-747-D859) .....	-	-	1	-	-
205614	Trunk rack frame bracket assembly left (Used on 571-3-8-9-581-583-631-3-8-9-641-3-5633-5633-A-731-2-3-8-9-41-43) .....	1	1	1	-	-
215573	Trunk rack frame bracket assembly right (Used on 730-4-5-6-7-47-D859) .....	-	-	1	-	-
205615	Trunk rack frame bracket assembly right (Used on models 570-4-5-6-7-630-4-5-6-7-647) .....	1	1	-	-	-
205616	Trunk rack frame bracket assembly right (Used on models 571-3-8-9-581-583-631-3-8-9-641-3-5633-5633-A-731-2-3-8-9-741-43) .....	1	1	1	-	-
144770	Trunk rack frame bracket pivot pin .....	2	2	2	-	-
5665	Blind nut 5/16-24 .....	2	2	2	-	-
5504	Trunk rack frame bracket pivot pin lockwasher 5/16" std. ....	2	2	2	-	-
3874	Washer 5/16" .....	2	2	2	-	-
184998	Trunk rack support screw assembly .....	2	2	2	-	-
191403	Trunk rack trim stick upper .....	4	4	4	-	-
191404	Trunk rack trim stick lower .....	4	4	4	-	-
5925	Screw 1/4-20 x 17/32" flat head .....	4	4	-	-	-
5924	Screw 1/4-20 x 3/8" flat head .....	16	16	-	-	-
6373	Screw 1/4-20 x 3/8" round head .....	20	20	20	-	-

## TRUNK RACK

223532	Trunk rack assembly (Specify color) .....	-	-	-	1	1
223505	Trunk rack pivot pin-short .....	-	-	-	2	2
223506	Trunk rack pivot pin-long .....	-	-	-	2	2



Piece No.	Name	No. Required				
		905 906	1005 1006	1107 1108	1207 1208	1407 1408
5665	Nut 5/16-24 blind .....	-	-	-	4	4
5504	Lockwasher 5/16" .....	-	-	-	4	4
3874	Washer 5/16" .....	-	-	-	4	4
194251	Trunk rack brace joint assembly .....	-	-	-	2	2
223509	Trunk rack to bracket lock screw plunger .....	-	-	-	2	2
230007	Trunk rack to bracket lock screw plunger seat .....	-	-	-	2	2
203166	Trunk rack emblem .....	-	-	-	1	1
5447	Lockwasher 1/4" Shakeproof .....	-	-	-	1	1
223982	Trunk rack and trunk rack frame bracket assembly (Specify color) (Used on all bodies except 836) .....	-	-	-	1	1
225087	Trunk rack and trunk rack frame bracket assembly (Specify color) (Used with body 836-936) .....	-	-	-	1	1
223984	Trunk rack frame bracket assembly-left (Specify color) (Used on all bodies except 836-936) .....	-	-	-	1	1
228956	Trunk rack frame bracket assembly-left (Specify color) (Supersedes 223516) (Used on bodies 836-936) .....	-	-	-	1	1
223986	Trunk rack frame bracket assembly-right (Specify color) (Used on all bodies except 836-936) .....	-	-	-	1	1
228957	Trunk rack frame bracket assembly-right (Specify color) (Used on bodies 836-936) .....	-	-	-	1	1
223507	Trunk rack frame bracket pivot pin .....	-	-	-	2	2
223512	Trunk rack frame bracket pivot pin shim .....	-	-	-	x	x
5665	Nut 5/16-24 blind .....	-	-	-	2	2
5504	Lockwasher 5/16" .....	-	-	-	2	2
3874	Washer 5/16" .....	-	-	-	2	2
223508	Trunk rack to trunk rack frame bracket lock screw 2-15/16" long .....	-	-	-	2	2
230006	Trunk rack to trunk rack frame bracket lock screw 2-9/16" long .....	-	-	-	2	-
191403	Trunk rack trim stick-upper .....	-	-	-	1	1
191404	Trunk rack trim stick-lower .....	-	-	-	4	4
6373	Screw 1/4-20 x 3/8" round head .....	-	-	-	20	20

## UNIVERSAL JOINT

202602	Universal joint shaft assembly (Used on 906 only) .....	1	-	-	-	-
202603	Universal joint shaft assembly (Used on 905 only) .....	1	-	-	-	-
213909	Universal joint shaft and flange assembly (Used on 1005 only) .....	-	1	-	-	-
213910	Universal joint shaft and flange assembly (Used on 1006 only) .....	-	1	-	-	-
NOTE:--The following parts used prior to Frame No. 901372 for 1005 and 901381 for 1006.						
205033	Universal joint shaft-front (Used on 905 only) .....	1	-	-	-	-
205034	Universal joint shaft-front (Used on 906 only) .....	1	-	-	-	-
194462	Universal joint shaft-rear .....	1	-	-	-	-
213052	Universal joint shaft and rear joint assembly (Used on 1005 only) .....	-	1	-	-	-
213053	Universal joint shaft and rear joint assembly (Used on 1006 only) .....	-	1	-	-	-
140065	Universal joint flange bolt 5/16-24 x 1" hex. hd. ....	12	-	-	-	-
121868	Universal joint flange bolt .....	-	12	-	-	-
5504	Lockwasher 5/16" .....	12	12	-	-	-
7005	Nut 5/16-24 .....	12	12	-	-	-
202491	Universal joint shaft bushing .....	-	8	-	-	-
202492	Universal joint shaft bushing retainer .....	-	8	-	-	-
186192	Universal joint shaft intermediate bearing .....	1	-	-	-	-

Piece No.	Name	No. Required				
		905 906	1005 1006	1107 1108	1207 1208	1407 1408
147381	Universal joint shaft intermediate bearing drip plug adapter .....	1	-	-	-	-
111538	Universal joint shaft intermediate bearing dust washer .	1	-	-	-	-
194795	Universal joint shaft intermediate bearing housing and support assembly .....	1	-	-	-	-
194787	Universal joint shaft intermediate bearing housing .....	1	-	-	-	-
194195	Universal joint shaft intermediate bearing housing cover .....	1	-	-	-	-
7824	Bolt 1/4-28 x 5/8" .....	6	-	-	-	-
5502	Lockwasher 1/4" .....	6	-	-	-	-
194202	Universal joint shaft intermediate bearing housing cover gasket .....	1	-	-	-	-
194197	Universal joint shaft intermediate bearing housing cover washer .....	1	-	-	-	-
194201	Universal joint shaft intermediate bearing housing cover washer retainer .....	1	-	-	-	-
194202	Universal joint shaft intermediate bearing housing cover washer retainer gasket .....	1	-	-	-	-
194190	Universal joint shaft intermediate bearing housing dust shield-front .....	1	-	-	-	-
194191	Universal joint shaft intermediate bearing housing dust shield front clamp .....	1	-	-	-	-
5667	Screw No. 10-32 x 5/8" round hd. ....	1	-	-	-	-
7003	Nut No. 10-32 .....	1	-	-	-	-
5500	Lockwasher No. 10 .....	1	-	-	-	-
194784	Universal joint shaft intermediate bearing housing dust shield-rear .....	1	-	-	-	-
190749	Universal joint shaft intermediate bearing housing support .....	1	-	-	-	-
7809	Screw 5/16-24 x 7/8" hex. hd. ....	8	-	-	-	-
7005	Nut 5/16-24 plain .....	9	-	-	-	-
5504	Lockwasher 5/16" std. ....	8	-	-	-	-
194546	Universal joint shaft intermediate bearing housing support shim-thick .....	x	-	-	-	-
194545	Universal joint shaft intermediate bearing housing support shim-thin .....	x	-	-	-	-
194194	Universal joint shaft intermediate bearing oil seal ....	2	-	-	-	-
194785	Universal joint shaft intermediate bearing oil seal retainer .....	1	-	-	-	-
194794	Universal joint shaft intermediate bearing housing oil seal retainer washer .....	1	-	-	-	-
194196	Universal joint shaft intermediate bearing retaining nut	1	-	-	-	-
194193	Universal joint shaft intermediate bearing retaining nut lock .....	1	-	-	-	-
194786	Universal joint shaft intermediate bearing spacer .....	1	-	-	-	-
134327	Universal joint cork washer .....	12	-	-	-	-
134312	Universal joint dust plug .....	1	-	-	-	-
134324	Universal joint felt washer .....	1	-	-	-	-
134321	Universal joint felt retainer .....	1	-	-	-	-
134323	Universal joint felt retainer washer .....	2	-	-	-	-
156319	Universal joint ferrule .....	12	-	-	-	-
156312	Universal joint flange yoke-front .....	1	-	-	-	-
205036	Universal joint flange yoke-rear .....	1	-	-	-	-
213043	Universal joint flange yoke .....	-	2	-	-	-
134318	Universal joint flange yoke-dowel .....	2	-	-	-	-
134315	Universal joint flange yoke-pin .....	3	-	-	-	-
134329	Universal joint hex. nut .....	24	-	-	-	-
156313	Universal joint housing-plain .....	3	-	-	-	-
156314	Universal joint housing-with oil holes .....	3	-	-	-	-

Piece No.	Name	No. Required				
		905 906	1005 1006	1107 1108	1207 1208	1407 1408
134317	Universal joint lock plate .....	12	-	-	-	-
134328	Universal joint oil hole plug .....	8	-	-	-	-
4559	Universal joint oil hole plug .....	-	2	-	-	-
213036	Universal joint sleeve-front outer casing .....	-	1	-	-	-
213035	Universal joint sleeve-front inner casing .....	-	1	-	-	-
213037	Universal joint sleeve-front casing baffle cup .....	-	1	-	-	-
213039	Universal joint sleeve casing gasket .....	-	2	-	-	-
213040	Universal joint sleeve casing packing .....	-	2	-	-	-
213041	Universal joint sleeve-front casing spring .....	-	1	-	-	-
213042	Universal joint sleeve dust cap .....	-	1	-	-	-
213044	Universal joint sleeve felt washer .....	-	1	-	-	-
213045	Universal joint sleeve steel washer .....	-	1	-	-	-
213046	Universal joint sleeve journal .....	-	2	-	-	-
213054	Universal joint sleeve yoke assembly .....	-	1	-	-	-
213055	Universal joint sleeve yoke .....	-	1	-	-	-
179817	Universal joint sleeve yoke assembly .....	1	-	-	-	-
134319	Universal joint sleeve yoke .....	1	-	-	-	-
205035	Universal joint splined yoke .....	2	-	-	-	-
156317	Universal joint trunnion bearing .....	12	-	-	-	-
156318	Universal joint trunnion spring washer .....	12	-	-	-	-
221677	Universal joint shaft assembly (Used on 1207) .....	-	-	-	1	-
221678	Universal joint shaft assembly (Used on 1208) .....	-	-	-	1	-

## UNIVERSAL JOINT

(Used after frame No. 901371 for 1005 and 901380 for 1006)

213909	Universal joint shaft and flange assembly (Used on 1005-1107) .....	1	1	1	-	-
213910	Universal joint shaft and flange assembly (Used on 1006-1108) .....	1	1	1	-	-
209174	Universal joint flange bolt (Use with square flange) ...	-	8	8	8	-
5508	Lockwasher 7/16" (Use with square flange) .....	-	8	8	8	-
7007	Nut 5/16-24 plain (Use with square flange) .....	-	8	8	8	-
140065	Universal joint flange bolt (Use with round flange) ....	-	-	12	12	12
5504	Lockwasher (Use with round flange) .....	-	-	12	12	12
7005	Nut (Use with round flange) .....	-	-	12	12	12
213962	Universal joint flange yoke (4-bolt) .....	-	2	2	2	2
219981	Universal joint flange yoke (6-bolt) .....	-	-	2	-	-
213969	Universal joint needle bearing assembly .....	-	8	8	8	8
4559	Universal joint oil hole plug .....	-	1	1	1	1
213975	Universal joint shaft (Used on 1005-1107) .....	-	1	1	-	-
213963	Universal joint shaft (Used on 1006-1108) .....	-	1	1	-	-
219985	Universal joint shaft (Used on 1107) .....	-	-	1	-	-
219986	Universal joint shaft (Used on 1108) .....	-	-	1	-	-
225540	Universal joint shaft (Used on 1207-1407) .....	-	-	-	1	1
225541	Universal joint shaft (Used on 1208-1408) .....	-	-	-	1	1
213042	Universal joint sleeve dust cap .....	-	1	1	-	-
213965	Universal joint sleeve journal assembly .....	-	1	2	2	2
213973	Universal joint sleeve journal gasket .....	-	8	8	8	8
213974	Universal joint sleeve journal gasket retainer .....	-	8	8	8	8
213970	Universal joint sleeve nipple .....	-	2	2	2	2
213971	Universal joint sleeve relief valve .....	-	2	2	2	2
213966	Universal joint sleeve washer (steel) .....	-	1	1	1	1
213967	Universal joint sleeve washer (cork) .....	-	1	1	1	1
213964	Universal joint sleeve yoke assembly .....	-	1	1	1	1
213972	Universal joint sleeve yoke plug .....	-	1	1	1	1
213968	Universal joint snap ring .....	-	8	8	8	8

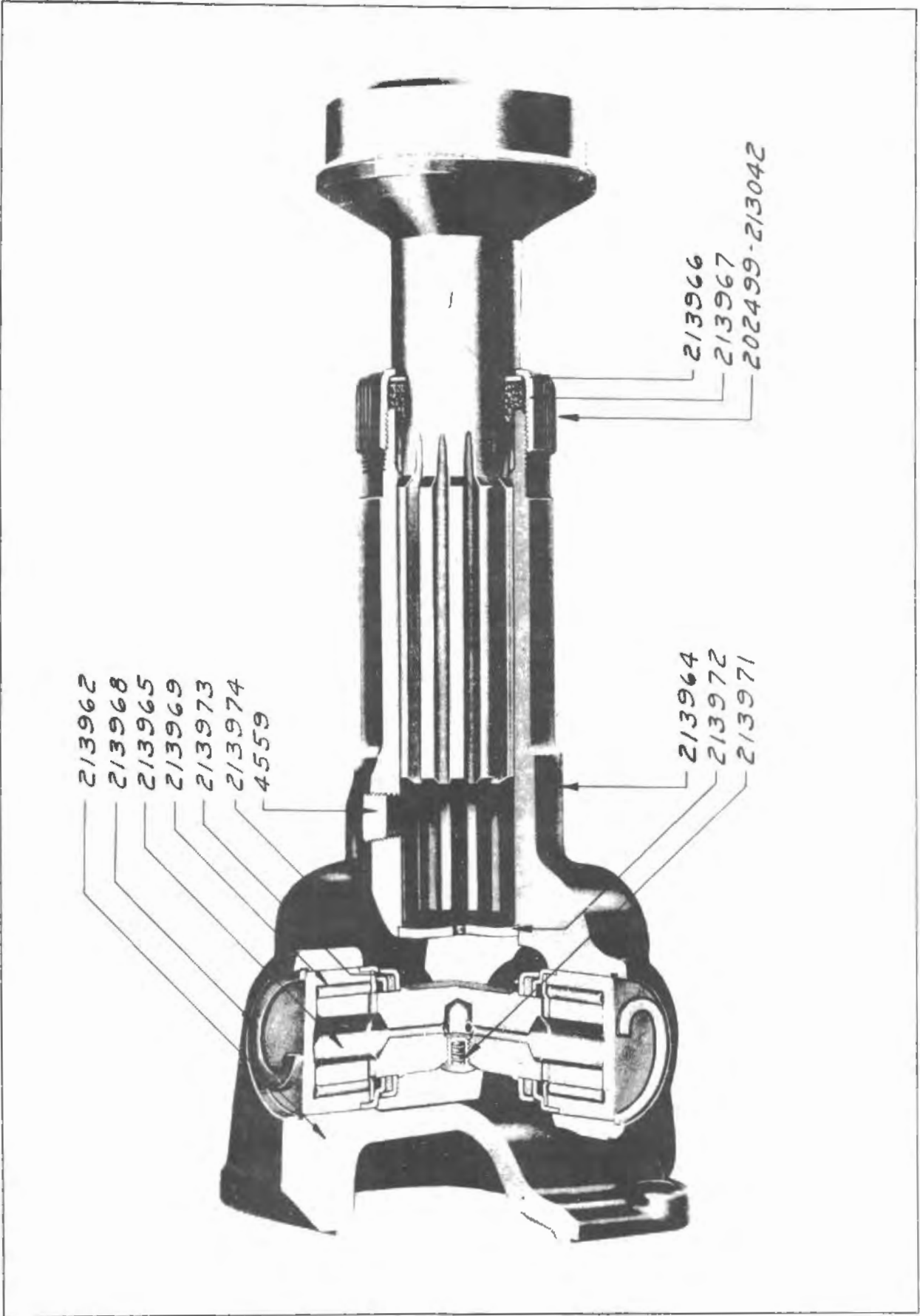

Piece No.	Name	No. Required				
		901 906	1005 1006	1107 1108	1207 1208	1407 1408
<b>WHEELS</b>						
98250	Wheel assembly (Wire) .....	5	-	-	-	-
98252	Wheel assembly (Wire) (Chromium plate) .....	5	-	-	-	-
98251	Wheel assembly (Wire) (Painted hubs and buffed spokes) .	5	-	-	-	-
98249	Wheel assembly (Wood) .....	5	-	-	-	-
205015	Wheel assembly (Wire) (Specify color) .....	-	5	5	5	5
205056	Wheel assembly (Wire) (Chromium plate) .....	-	5	5	5	5
209812	Wheel assembly (Wood) .....	-	5	5	5	5
213821	Wheel balancing weight .....	-	-	x	x	-
228784	Wheel balancing weight .....	-	-	-	-	x
6434	Set screw 1/4-20 x 3/8 headless cup point .....	-	-	x	x	-
6635	Set screw 1/4-20 x 5/16 cone point headless .....	-	-	-	-	x
197382	Wheel bolt (Wire) .....	-	26	26	24	24
197945	Wheel bolt (Wood) .....	-	26	26	24	24
131828	Wheel bolt (Wire) .....	32	-	-	-	-
173187	Wheel bolt (Wood) .....	32	-	-	-	-
216559	Wheel brake drum dampener spring .....	-	4	4	4	4
203193	Wheel brake drum inspection hole cover .....	4	-	-	-	-
209444	Wheel brake drum inspection hole cover .....	-	4	4	4	4
203192	Screw 1/4-20 x 5/16" round head .....	4	-	-	-	-
181404	Wheel hub adapter (Wood) .....	4	-	-	-	-
180929	Wheel hub cap (Wood) .....	4	-	-	-	-
181438	Wheel hub cap front (Wire) .....	2	2	2	2	2
203171	Wheel hub and drum assembly front .....	2	-	-	-	-
207405	Wheel hub and drum assembly front .....	-	2	2	2	2
203188	Wheel hub and drum assembly rear .....	2	-	-	-	-
207404	Wheel hub and drum assembly rear .....	-	2	2	2	2
203184	Wheel hub and drum water seal .....	4	4	-	-	-
210423	Wheel hub cover and emblem assembly (Specify color) (Wood) .....	-	5	5	4	4
209952	Wheel hub cover emblem (Wood) .....	-	5	5	4	4
210691	Wheel hub cover liner (Wood) .....	-	5	5	4	4
210692	Wheel hub cover liner retainer (Wood) .....	-	5	5	4	4
209773	Wheel hub cover retaining ring (Wood) .....	-	5	-	-	-
216122	Wheel hub cover retaining ring (Wood) .....	-	-	5	4	5
6299	Wheel hub cover retaining ring screw 5/16-18 x 5/16" hex. hd. (Wood) .....	-	15	15	15	15
167261	Wheel hub cover retaining ring screw .....	-	-	15	15	15
5504	Lockwasher 5/16" (Wood) .....	-	15	15	15	15
3867	Washer 3/16" .....	-	-	15	15	15
228927	Wheel hub shell cover and emblem assembly (Specify color) (Wire) (Supersedes 210427) .....	-	5	5	4	4
209877	Wheel hub shell cover emblem (Wire) .....	-	5	5	4	4
203170	Wheel hub shell cover assembly (Wire) .....	5 <sup>4</sup>	-	-	-	-
203533	Wheel hub shell cover emblem (Wire) .....	5	-	-	-	-
207339	Wheel hub shell cover spring (Wire) .....	15	-	-	-	-
203611	Wheel rim flange ring 18 x 5" base .....	5	-	-	-	-
219134	Wheel rim liner .....	-	5	5	5	5
228919	Wheel shield assembly (For wire wheels) (Chromium plate) (Supersedes 228513) .....	-	-	-	5	5
228921	Wheel shield assembly (For wire wheels) (Painted) (Supersedes 223688) .....	-	-	-	5	5
223450	Wheel shield cushion .....	-	-	-	30	15
5739	Wheel shield screw No. 10-32 x 1/2" .....	-	-	-	30	-
7003	Nut No. 10-32 .....	-	-	-	30	-
5935	Lockwasher No. 10 Shakeproof .....	-	-	-	30	-
228923	Wheel shield retainer clip .....	-	-	-	15	15
4148	Rivet 3/16 x 1/4 rnd. hd. .....	-	-	-	15	15

Piece No.	Name	No. Required				
		905 906	1005 1006	1107 1108	1207 1208	1407 1408
203579	Wheel spoke-long (Wire) (Buffed) .....	120	-	-	-	-
203589	Wheel spoke-long (Wire) (Chromium plate) .....	120	-	-	-	-
203578	Wheel spoke-short (Wire) (Buffed) .....	180	-	-	-	-
203588	Wheel spoke-short (Wire) (Chromium plate) .....	180	-	-	-	-
205064	Wheel spoke inner-short (Diameter at hub .250) .....	-	x	-	-	-
205062	Wheel spoke inner-long (Diameter at hub .250) .....	-	x	x	-	-
205060	Wheel spoke outer (Diameter at hub .250) .....	-	x	-	-	-
205066	Wheel spoke nipple .....	-	x	x	x	x
213541	Wheel spoke outer (Diameter at hub .281) .....	-	x	x	x	x
213539	Wheel spoke inner-long (Diameter at hub .281) .....	-	x	x	x	x
213540	Wheel spoke inner-short (Diameter at hub .281) .....	-	x	x	x	x
203597	Wheel spoke nipple (Wire) (Chromium plate) .....	300	-	-	-	-
215062	Wheel trim ring .....	-	5	5	5	5
223447	Wheel trim ring assembly 16-11/16" diameter (Use with shield) .....	-	-	-	5	-
228851	Wheel trim ring assembly 16-19/32" diameter (Use with shield) .....	-	-	-	5	5
223451	Wheel trim ring screw .....	30	-	-	30	-
5861	Lockwasher No. 8 Shakeproof .....	-	-	-	30	-
7002	Nut No. 8-32 .....	-	-	-	30	-

## WHEEL CARRIER

5980	Rear wheel carrier bracket to frame rear end cross channel bolt (Screw 7/16-20 x 1-5/16" hex. hd.) .....	2	-	-	-	-
7951	Rear wheel carrier bracket to frame rear end cross channel bolt (Screw 7/16-20 x 1-1/4" hex. hd.) .....	-	2	2	-	-
7007	Nut 7/16-20 .....	-	2	2	-	-
5508	Lockwasher 7/16" .....	-	2	2	-	-
7107	Nut 7/16-20 castle .....	2	-	-	-	-
5508	Lockwasher 7/16" .....	2	-	-	-	-
4291	Cotter pin 3/32 x 3/4" .....	2	-	-	-	-
194833	Washer 7/16" plain .....	2	2	2	-	-
194092	Rear wheel carrier bracket (Double wheel carrier) .....	1	-	-	-	-
181873	Rear wheel carrier bracket bolt (Double carrier) .....	2	-	-	-	-
4019	Cotter pin 3/8 x 13/16" (Double carrier) .....	1	-	-	-	-
195910	Rear wheel carrier bracket brace .....	1	-	-	-	-
207327	Rear wheel carrier bracket brace (Used on bodies 631-3-8-9-641-3-731-2-3-8-9-41-43-D858) .....	-	1	1	-	-
205605	Rear wheel carrier bracket brace (Used on bodies 630-4-5-6-7-647-730-4-5-6-7-747-D859) .....	-	1	1	-	-
205622	Rear wheel carrier bracket brace nut .....	-	1	1	-	-
7010	Nut 5/8-18 .....	1	1	1	-	-
5514	Lockwasher 5/8" .....	2	2	2	-	-
196847	Nut 5/8" U.S. thd. .....	1	-	-	-	-
194088	Rear wheel carrier bracket brace-right (Double carrier) .....	1	-	-	-	-
194087	Rear wheel carrier bracket brace-left (Double carrier) .....	1	-	-	-	-
5514	Lockwasher 5/8" (Double carrier) .....	4	-	-	-	-
7010	Nut 5/8-18 (Double carrier) .....	8	-	-	-	-
180949	Rear wheel carrier bracket liner .....	1	1	2	-	-
207382	Rear wheel carrier bracket and dowel assembly (Used on bodies 631-3-8-9-641-643-5633-5633-A-731-2-3-8-9-741-43-D858) .....	-	1	1	-	-
205631	Rear wheel carrier bracket and support plate assembly (Used on bodies 630-4-5-6-7-647-730-4-5-6-7-747-D859) .....	-	1	1	-	-
190097	Rear wheel carrier bracket and support plate assembly ..	1	-	-	-	-
182479	Rear wheel carrier lock .....	1	-	-	-	-
201644	Rear wheel carrier lock (With key) .....	-	1	1	-	-

## SERVICE PARTS LIST—PACKARD TWELVE

Wheel Carrier 201

Piece No.	Name	No. Required				
		905 906	1005 1006	1107 1108	1207 1208	1407 1408
101199	Washer .....	-	1	-	-	-
201643	Rear wheel carrier lock plate .....	-	1	1	-	-
181055	Rear wheel carrier lock plate and retainer assembly (Wire) .....	1	-	-	-	-
169567	Rear wheel carrier lock plate and retainer assembly (Wood) .....	1	-	-	-	-
195909	Rear wheel carrier lock plate nut (Wire) .....	1	-	-	-	-
195906	Rear wheel carrier lock plate nut (Wood) .....	1	-	-	-	-
148846	Rear wheel carrier lock plate nut retainer .....	1	-	-	-	-
169564	Rear wheel carrier lock retainer .....	1	-	-	-	-
201654	Rear wheel carrier lock retainer .....	-	1	1	-	-
146316	Rear wheel carrier pin (Wire) .....	2	-	-	-	-
146317	Rear wheel carrier pin .....	2	-	-	-	-
5510	Lockwasher 1/2" .....	2	-	-	-	-
7008	Nut 1/2-20 .....	2	-	-	-	-
194093	Rear wheel carrier spacer assembly (Double carrier) ....	1	-	-	-	-
201646	Rear wheel carrier spacer (Wood) .....	-	1	1	-	-
5510	Lockwasher 1/2" (Wood) .....	-	1	1	-	-
195907	Rear wheel carrier spacer stud (Double carrier) .....	1	-	-	-	-
164724	Rear wheel carrier spacer tie rod (Double carrier) ....	1	-	-	-	-
7010	Nut 5/8-18 (Double carrier) .....	2	-	-	-	-
5514	Lockwasher 5/8" (Double carrier) .....	2	-	-	-	-
194686	Side wheel carrier bracket right assembly .....	1	-	-	-	-
209251	Side wheel carrier bracket right assembly .....	-	1	1	-	-
194687	Side wheel carrier bracket left assembly .....	1	-	-	-	-
209250	Side wheel carrier bracket left assembly .....	-	1	1	-	-
5929	Side wheel carrier bracket bolt 7/16-20 x 1-5/8" hex. hd. ....	8	8	8	-	-
7952	Screw 7/16-20 x 7/8" hex. hd. ....	-	-	2	-	-
5508	Lockwasher 7/16" .....	8	10	10	-	-
7007	Nut 7/16-20 .....	8	10	10	-	-
194691	Side wheel carrier bracket brace-right (Black enamel) ..	1	-	-	-	-
194690	Side wheel carrier bracket brace-left (Black enamel) ...	1	-	-	-	-
209237	Side wheel carrier bracket brace-left (Used on bodies 633-4-5-6-7-8-5633-5633-A-732-3-4-5-6-7) .....	-	1	1	-	-
210759	Side wheel carrier bracket brace-left (Used on bodies 630-1-9-641-3-7-730-1-8-9-741-3-7) .....	-	1	1	-	-
209238	Side wheel carrier bracket brace-right (Used on bodies 633-4-5-6-7-8-5633-5633-A-732-3-4-5-6-7) .....	-	1	1	-	-
210765	Side wheel carrier bracket brace-right (Used on bodies 630-1-9-641-3-7-730-1-8-9-741-3-7) .....	-	1	1	-	-
205722	Side wheel carrier bracket brace-right (Chromium plate) ..	1	-	-	-	-
205723	Side wheel carrier bracket brace-left (Chromium plate) ..	1	-	-	-	-
170074	Side wheel carrier bracket brace nut-outer .....	2	2	2	-	-
7008	Side wheel carrier bracket brace nut-inner .....	2	2	2	-	-
5510	Lockwasher 1/2" std. ....	2	2	2	-	-
194019	Side wheel carrier bracket brace grommet .....	2	2	2	-	-
210810	Side wheel carrier bracket to fender grommet-right .....	-	1	1	-	-
210809	Side wheel carrier bracket to fender grommet-left .....	-	1	1	-	-
194769	Side wheel carrier bracket to running board splashers grommet-right .....	1	-	-	-	-
194768	Side wheel carrier bracket to running board splashers grommet-left .....	1	-	-	-	-
182479	Side wheel carrier lock .....	2	-	-	-	-
201644	Side wheel carrier lock .....	-	2	2	-	-
101199	Washer plain .....	-	2	-	-	-
181055	Side wheel carrier lock plate and retainer assembly (Wire) .....	2	-	-	-	-
169567	Side wheel carrier lock plate and retainer assembly (Wood) .....	2	-	-	-	-



Piece No.	Name	No. Required				
		905 906	1005 1006	1107 1108	1207 1208	1407 1408
195903	Side wheel carrier lock plate nut (Wire) .....	2	-	-	-	-
195906	Side wheel carrier lock plate nut (Wood) .....	2	-	-	-	-
148846	Side wheel carrier lock plate nut retainer .....	2	-	-	-	-
169564	Side wheel carrier lock retainer .....	2	-	-	-	-
201654	Side wheel carrier lock retainer .....	-	2	2	-	-
194011	Side wheel carrier pin (Wire) .....	2	-	-	-	-
209263	Side wheel carrier pin .....	-	2	2	-	-
7008	Nut 1/2-20 plain .....	2	2	2	-	-
205769	Nut (Acorn) .....	4	2	2	-	-
5510	Lockwasher 1/2" .....	4	2	2	-	-
201646	Side wheel carrier spacer (Wood) .....	-	2	2	-	-
5510	Lockwasher (Wood) .....	-	2	2	-	-
<b>WHEEL CARRIER</b>						
225824	Rear wheel carrier bracket and dowel assembly (Specify color) (Use with bodies 838-39-938-39) .....	-	-	-	1	1
225727	Rear wheel carrier bracket brace (Specify color) (Use with bodies 838-39-938-939) .....	-	-	-	1	1
6361	Lockwasher 3/4" Shakeproof (Use with bodies 838-39-938-939) .....	-	-	-	2	2
158003	Nut (Specify color) (Use with bodies 838-39-938-939) .....	-	-	-	2	2
225817	Rear wheel carrier bracket brace grommet (Use with bodies 838-39-938-939) .....	-	-	-	1	1
207332	Rear wheel carrier bracket dowel (Use with bodies 838-39-938-39) .....	-	-	-	2	2
225806	Rear wheel carrier bracket to frame screw (Use with bodies 838-39-938-39) .....	-	-	-	2	2
5518	Lockwasher 3/4" (Use with bodies 838-39-938-39) .....	-	-	-	2	2
225821	Rear wheel carrier bracket grommet (Use with bodies 838-39-938-39) .....	-	-	-	2	2
201644	Rear wheel carrier lock (With key) (Use with bodies 838-39-938-939) .....	-	-	-	1	1
201643	Rear wheel carrier lock plate (Use with bodies 838-39-938-939) .....	-	-	-	1	1
201654	Rear wheel carrier lock retainer (Use with bodies 838-39-938-39) .....	-	-	-	1	1
224628	Rear wheel carrier tire clamp assembly (Use with bodies 836-37-827-873-936-37-27-73) .....	-	-	-	1	1
226047	Rear wheel carrier tire clamp assembly (Use with bodies 832-33-830-L194-L195-34-35-821-31-930-32-33-34-35-21-31-L294-L295) .....	-	-	-	-	2
224656	Rear wheel carrier tire clamp bolt .....	-	-	-	x	x
3891	Washer 5/8" plain .....	-	-	-	x	x
225893	Side wheel carrier rear clamp bolt hole plug .....	-	-	-	x	x
228841	Side wheel carrier bracket left (Specify color) (Supersedes 223953) .....	-	-	-	1	1
228842	Side wheel carrier bracket right (Specify color) (Supersedes 223954) .....	-	-	-	1	1
223965	Side wheel carrier bracket bolt-upper 1/2-20 x 4-1/4 ....	-	-	-	4	4
223966	Side wheel carrier bracket bolt-lower 1/2-20 x 5-1/4 ....	-	-	-	2	2
5510	Lockwasher 1/2" .....	-	-	-	6	6
7008	Nut 1/2-20 plain .....	-	-	-	6	6
225408	Side wheel carrier bracket to fender grommet .....	-	-	-	2	2
225957	Side wheel carrier bracket to frame bolt washer (1/2 plain special) .....	-	-	-	4	-
225778	Side wheel carrier bracket wheel adapter retaining screw. ....	-	-	-	4	4
201643	Side wheel carrier lock plate .....	-	-	-	2	2
201654	Side wheel carrier lock retainer .....	-	-	-	2	2
223959	Side wheel carrier lock (With key) .....	-	-	-	2	2
201646	Side wheel carrier spacer (Wood wheels) .....	-	-	-	2	2
5510	Lockwasher 1/2 (Wood wheels) .....	-	-	-	2	2
228847	Side wheel carrier wheel adapter assembly (Supersedes 223958) .....	-	-	-	2	2

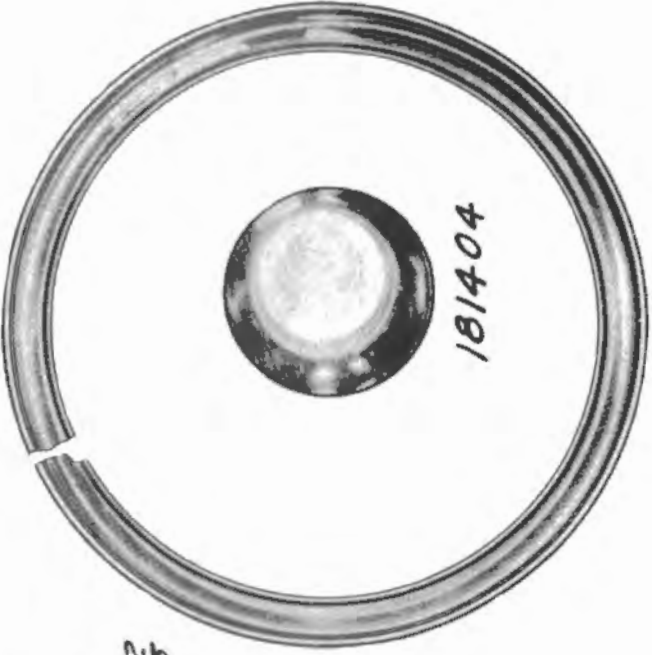

181404

194690-194691  
209237-209238-205722  
205723-210759-210765

164724



169567



203611

194087-194088



205088

210427



203170



180929

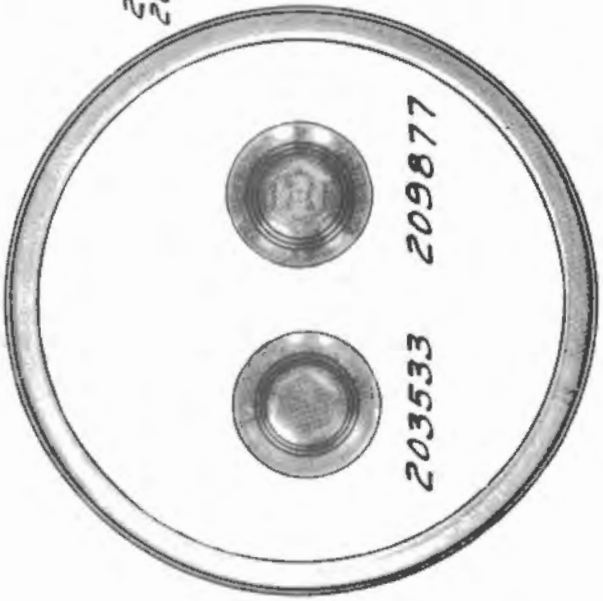

203533

209877

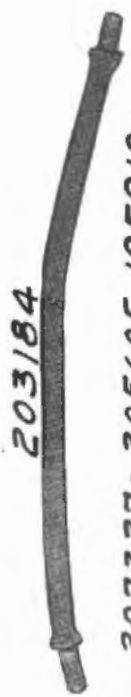

203184

207327-205605-195910



209953

210423



201643  
169564  
181055  
201646  
194768  
210809  
210810

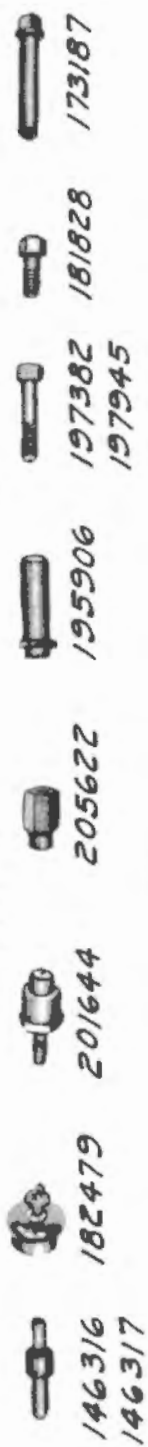

146316  
146317  
182479  
201644  
205622  
195906  
197382  
181828  
173187  
197945



194092  
207382  
205631  
190097



181438  
194686-194687  
209250-209251  
209773  
194093

Piece No.	Name	No. Required		
		570	571	581
<b>BODY ATTACHING PARTS</b>				
187627	Body to frame bolt No. 1 carriage bolt (7/16-20 x 2-11/16" skew head).	2	2	2
5282	Body to frame bolt No. 2 screw (7/16-20 x 3-1/2" hex. hd. mach.) .....	2	2	2
5970	Body to frame bolt No. 3 screw (7/16-20 x 5" hex. hd. mach.) .....	2	2	2
5968	Body to frame bolt No. 4 screw (7/16-20 x 4" flat hd. mach.) .....	2	2	2
5671	Body to frame bolt No. 5 screw (7/16-20 x 5-3/8" hex. hd. mach.) .....	2	-	-
5969	Body to frame bolt No. 5 screw (7/16-20 x 7-3/8" hex. hd. mach.) .....	-	2	2
182439	Body to frame bolt nut lock .....	4	4	4
131809	Body to frame bolt washer-large (7/16" plain special) .....	2	2	2
131046	Body to frame bolt washer-small (7/16" plain special) .....	12	10	10
5508	Body to frame bolt lockwasher (7/16" std.) .....	8	8	8
5806	Body to frame bolt lockwasher .....	2	2	2
7007	Body to frame bolt nut (7/16"-20) .....	8	6	6
193883	Body to frame liner (3/16" thick) .....	x	x	x
185271	Body to frame liner (1/4" thick) .....	x	x	x
185272	Body to frame liner (5/16" thick) .....	x	x	x
193930	Body to frame liner (3/16" thick) .....	x	-	-
193931	Body to frame liner (3/16" thick) .....	-	x	x
167924	Body to frame liner hand brake lever insulator .....	1	1	1
185270	Body hold down bolt bracket liner (3/8" thick) .....	x	x	x
185274	Body hold down bolt bracket liner (1/2" thick) .....	x	x	x
185273	Body hold down bolt bracket liner (3/16" thick) .....	x	x	x
133104	Body hold down bolt bracket liner (1/32" thick) .....	x	x	x

### BONNET DASH LINER

139804	Bonnet dash liner (in rolls) .....	x	x	x
187260	Bonnet dash liner hook .....	2	2	2
3866	Washer (3/16") .....	2	2	2
7002	Nut (No. 8-32) .....	2	2	2

### CABLES

167069	Body wiring cable 19 strand No. 16 (green braid) .....	x	x	x
166406	Body wiring cable 19 strand No. 16 (red braid) .....	x	x	x
166404	Body wiring cable 19 strand No. 16 (black braid) .....	x	x	x
29254	Body wiring cable staple (insulated) .....	x	x	x
159085	Body wiring cable terminal .....	x	x	x
33287	Body wiring cable terminal .....	x	x	x
36111	Body wiring cable terminal insulator .....	x	x	x

### CARPET

193826	Carpet folding seat floor assembly .....	2	-	-
200483	Carpet-front assembly .....	1	-	-
200482	Carpet-front assembly .....	-	1	1
193847	Carpet-rear assembly .....	1	-	-
193848	Carpet-rear assembly .....	-	1	1

### DOORS

All doors must be adjusted to each respective body. To obtain satisfactory replacement of doors, it is advisable to return the damaged door to be repaired, if possible. If this cannot be done the customer assumes the responsibility of the new door being a satisfactory fit. Specify on all orders the upholstery material, color of paint and striping.

Piece No.	Name	No. Required		
		570	571	581
195483	Door-front left assembly trimmed .....	1	1	1
195485	Door-front right assembly trimmed .....	1	1	1
195487	Door-rear left assembly trimmed .....	1	1	1
195489	Door-rear right assembly trimmed .....	1	1	1

## DOOR PARTS

111671	Door bumper .....	8	8	8
185143	Door check-left .....	1	1	1
185142	Door check-right .....	1	1	1
177021	Door check escutcheon plate .....	2	2	2
183394	Screw (No. 6 x 3/8" oval hd. mach.) .....	6	6	6
185235	Door check stop plate assembly-left .....	1	1	1
185233	Door check stop plate assembly-right .....	1	1	1
180704	Door curtain carrier rod-left .....	2	-	-
176125	Door curtain carrier rod-left .....	-	2	2
180703	Door curtain carrier rod-right .....	2	-	-
176124	Door curtain carrier rod-right .....	-	2	2
165759	Door curtain carrier socket .....	4	4	4
119226	Door dovetail bumper .....	8	8	8
119245	Door dovetail bumper clip .....	8	8	8
119297	Door dovetail casing .....	4	4	4
119296	Door dovetail female retainer .....	4	4	4
119298	Door dovetail-male .....	4	4	4
118500	Door hinge .....	8	8	8
165021	Door lock .....	4	4	4
173952	Door lock handle .....	4	-	-
176788	Door lock handle .....	-	4	4
165015	Door lock lever assembly-left .....	2	2	2
165014	Door lock lever assembly-right .....	2	2	2
168020	Door lock lever handle nut .....	4	4	4
174113	Door lock lever handle-right .....	2	2	2
174114	Door lock lever handle-left .....	2	2	2
165541	Door lock lever handle pocket moulding-right .....	2	2	2
165542	Door lock lever handle pocket moulding-left .....	2	2	2
174115	Door lock lever and link assembly-front right .....	1	1	1
174116	Door lock lever and link assembly-front left .....	1	1	1
173814	Door lock striker-right .....	2	2	2
174223	Door lock striker-left .....	2	2	2
193656	Door scuff plate-front left .....	1	1	1
193655	Door scuff plate-front right .....	1	1	1
193642	Door scuff plate-rear right .....	1	1	1
193643	Door scuff plate-rear left .....	1	1	1

## FASTENERS

193199	Snap fastener rivet post-female-carpet .....	x	x	x
193200	Snap fastener machine screw post-carpet .....	x	x	x
193201	Snap fastener screw post-carpet .....	x	x	x
159060	Snap fastener screw stud-carpet .....	x	x	x
115799	Snap fastener socket-carpet .....	x	x	x
115798	Snap fastener socket ring-carpet-short prong .....	x	x	x
115268	Snap fastener machine screw post-single-top curtain .....	x	x	x
116554	Snap fastener machine screw post-double-top curtain .....	x	x	x
139157	Snap fastener rivet post-female-door pocket .....	x	x	x
139160	Snap fastener rivet post-male-long-door pocket .....	x	x	x
139157	Snap fastener rivet post-female-top curtain .....	x	x	x
139158	Snap fastener rivet post-male-top curtain .....	x	x	x
148677	Snap fastener rivet post-male-top curtain .....	x	x	x

Piece No.	Name	No. Required		
		570	571	581
112058	Snap fastener screw post-top curtain .....	x	x	x
139150	Snap fastener socket-female-door pocket .....	x	x	x
76926	Snap fastener socket-female-top curtain .....	x	x	x
139150	Snap fastener socket-female-top curtain .....	x	x	x
139159	Snap fastener socket-top-door panel .....	x	x	x
76925	Snap fastener socket-male-short prong-top curtain .....	x	x	x
139159	Snap fastener top-top-curtain .....	x	x	x
116446	Snap fastener wood screw post-double-top curtain .....	x	x	x
106755	Snap fastener wood screw post-single-top curtain .....	x	x	x

## FLOOR BOARD

185702	Floor board-front assembly .....	-	1	1
185703	Floor board-front assembly .....	1	-	-
185705	Floor board-front filler .....	1	-	-
185704	Floor board-front filler .....	-	1	1
195242	Floor board-front felt-center .....	1	1	1
187634	Floor board-front felt-front center .....	-	1	1
187631	Floor board-front felt-front side .....	-	2	2
185709	Floor board-front felt-rear .....	-	1	1
187632	Floor board-front felt-side .....	-	2	2
187633	Floor board-front felt-side .....	2	-	-
196000	Floor board-rear assembly .....	1	-	-

## FOLDING SEAT

193961	Folding seat-trimmed assembly .....	2	-	-
187498	Folding seat-untrimmed assembly .....	2	-	-
169102	Folding seat back-untrimmed assembly .....	2	-	-
167945	Folding seat back to seat frame screw .....	4	-	-
187417	Folding seat floor plate .....	1	-	-
171692	Folding seat frame assembly .....	2	-	-
5580	Screw (No. 10-32 x 1" flat hd. mach.) .....	16	-	-
5229	Screw (1/4-28 x 1-3/8" flat hd. mach.) .....	8	-	-
8220	Screw (1/4-28 x 1-1/2" flat hd. mach.) .....	8	-	-
7003	Nut (No. 10-32) .....	16	-	-
7004	Nut (1/4"-28) .....	16	-	-
3867	Washer (3/16") .....	4	-	-
171698	Folding seat frame side-left .....	2	-	-
171703	Folding seat frame side-right .....	2	-	-
184024	Folding seat handle .....	2	-	-
100100	Folding seat pivot pin .....	4	-	-
187421	Folding seat pivot pin retainer .....	2	-	-
8204	Screw (1/4-28 x 2" flat hd. mach.) .....	4	-	-
187410	Folding seat support-left .....	2	-	-
187411	Folding seat support-right .....	2	-	-
130869	Folding seat support to seat frame screw .....	4	-	-
7006	Nut (3/8"-24) .....	4	-	-
5506	Lockwasher .....	4	-	-

## FOOT REST

163745	Foot rest assembly .....	-	1	1
163743	Foot rest assembly .....	1	-	-
147963	Foot rest pivot stud .....	2	-	-
180134	Nut .....	-	-	2

Piece No.	Name	No. Required		
		570	571	581
<b>FRONT SEAT</b>				
179717	Front seat-left frame carrier bracket .....	1	1	1
4242	Rivet (3/16 x 1/2") .....	10	10	10
180842	Front seat-left locking stud .....	1	1	1
183528	Front seat-left locking spring .....	1	1	1
180666	Front seat-left operating spring .....	1	1	1
180845	Front seat-left support bar assembly .....	1	1	1
180844	Front seat-left support bar handle .....	1	1	1

### INSTRUMENT BOARD

199742	Instrument board assembly .....	1	1	1
193866	Instrument board compartment door frame assembly-right .....	1	1	1
193867	Instrument board compartment door frame assembly-left .....	1	1	1
5724	Screw (No. 8-32 x 3/8" oval hd. mach.) .....	4	4	4
5860	Washer (No. 8) .....	4	4	4
185893	Instrument board compartment door anti-rattler .....	2	2	2
180307	Instrument board compartment door hinge assembly .....	2	2	2
5859	Rivet (3/16 x 5/16" tub. rnd. hd.) .....	4	4	4
187495	Instrument board compartment door knob .....	2	2	2
5569	Screw (No. 10-32 x 1/2" fill. hd. mach.) .....	2	2	2
5500	Lockwasher (1/4") .....	2	2	2
184761	Instrument board compartment door panel assembly-right .....	1	1	1
184762	Instrument board compartment door panel assembly-left .....	1	1	1
105029	Instrument board compartment door spring dowel .....	2	2	2
180301	Instrument board compartment door striker plate .....	2	2	2
141649	Rivet (3/16 x 1/4" rnd. hd. tub.) .....	4	4	4
190674	Instrument board steering post bracket support .....	1	1	1
5764	Screw (1/4-28 x 3/4" oval hd. mach.) .....	2	2	2
5471	Screw (1/4-28 x 3/4" hex. hd. mach.) .....	2	2	2
3868	Washer (1/4") .....	2	2	2
5502	Lockwasher (1/4") .....	4	4	4
7004	Nut (1/4"-28) .....	2	2	2
184716	Instrument board steering post bracket support liner .....	1	1	1

### PANEL

199849	Panel-cowl assembly .....	1	1	1
199848	Panel-dash assembly .....	1	1	1
199748	Panel-dash cover assembly .....	1	1	1
199709	Panel-dash interliner .....	1	1	1
199707	Panel-dash liner .....	1	1	1
193400	Panel-door front right assembly .....	1	1	1
193401	Panel-door front left assembly .....	1	1	1
193402	Panel-door rear right assembly .....	1	1	1
193403	Panel-door rear left assembly .....	1	1	1

### REAR VIEW MIRROR

176816	Rear view mirror assembly .....	1	1	1
5589	Screw (No. 10-32 x 1/2" rnd. hd.) .....	2	2	2
163885	Nut (No. 10-32 blind special) .....	2	2	2
191368	Rear view mirror glass .....	1	1	1



Piece No.	Name	No. Required		
		370	571	581
<b>ROBE RAIL</b>				
174501	Robe rail assembly .....	1	1	-

### SEAT CUSHION AND SPRING

193602	Seat back spring-front right .....	1	1	1
193603	Seat back spring-front left .....	1	1	1
193791	Seat back spring-rear .....	1	-	-
193664	Seat back spring-rear .....	-	1	1
193861	Seat cushion assembly-front left .....	1	1	1
193863	Seat cushion assembly-front right .....	1	1	1
204195	Seat cushion assembly-rear (Use with angle set axle) .....	-	1	1
193875	Seat cushion assembly-rear .....	1	-	-
193877	Seat cushion assembly-rear (Use with standard rear axle) .....	-	1	1
183280	Seat cushion spring-front left .....	1	1	1
183259	Seat cushion spring-front right .....	1	1	1
193666	Seat cushion spring-rear (Use with standard rear axle) .....	-	1	1
204257	Seat cushion spring-rear (Use with angle set axle) .....	-	1	1
172294	Seat cushion spring-folding seat .....	2	-	-

### SPOTLIGHT

185301	Spotlight assembly .....	1	1	1
102507	Spotlight cable grommet .....	1	1	1
187910	Spotlight bracket .....	1	1	1

### TONNEAU COWL

178705	Tonneau cowl trimmed assembly .....	-	-	1
176786	Tonneau cowl bumper .....	-	-	2
176314	Tonneau cowl clamp .....	-	-	2
204548	Tonneau cowl clamp screw .....	-	-	4
176315	Tonneau cowl clamp bracket and bumper retainer .....	-	-	2
176288	Tonneau cowl counterbalance assembly .....	-	-	2
176638	Tonneau cowl counterbalance screw-lower .....	-	-	2
177006	Tonneau cowl counterbalance screw-upper .....	-	-	2
176657	Tonneau cowl counterbalance bracket-lower .....	-	-	2
176289	Tonneau cowl counterbalance spring .....	-	-	2
176312	Tonneau cowl hinge female-right .....	-	-	1
176313	Tonneau cowl hinge female-left .....	-	-	1
5595	Screw (3/8-24 x 1-3/4" hex. hd. mach.) .....	-	-	4
5506	Lockwasher (3/8") .....	-	-	4
176658	Tonneau cowl hinge male-right .....	-	-	1
176659	Tonneau cowl hinge male-left .....	-	-	1
176318	Tonneau cowl hinge screw .....	-	-	2

### TONNEAU LIGHT

180645	Tonneau light assembly .....	2	2	2
102590	Tonneau light bulb-7V. 3 C-P. G-6 single contact .....	2	2	2
180646	Tonneau light glass and rim .....	2	2	2
180647	Tonneau light reflector .....	2	2	2
185031	Tonneau light switch .....	2	2	2
127502	Tonneau light switch plunger plate .....	2	2	2

Piece No	Name	No. Required		
		570	571	581
<b>TONNEAU VENTILATOR</b>				
176296	Tonneau ventilator cover assembly-left .....	-	-	1
176650	Tonneau ventilator cover assembly-right .....	-	-	1
176301	Tonneau ventilator cover spring .....	-	-	2
4153	Tonneau ventilator hinge rivet (3/16 x 7/16" rnd. hd.) .....	-	-	4
176304	Tonneau ventilator knob .....	-	-	2
176300	Tonneau ventilator screen .....	-	-	2

### TOOL COMPARTMENT

200527	Tool compartment door assembly .....	-	1	1
139046	Tool compartment door hinge .....	-	1	1
148304	Tool compartment door lock .....	-	1	1
111568	Tool compartment door lock striker .....	-	1	1

### TOP

193612	Top assembly .....	1	-	-
176100	Top assembly .....	-	1	1
176105	Top bow No. 1 .....	-	1	1
176133	Top bow No. 1 .....	1	-	-
180326	Top bow No. 2 .....	1	-	-
176106	Top bow No. 2 .....	-	1	1
193496	Top bow No. 3 .....	1	-	-
193497	Top bow No. 3 .....	-	1	1
193450	Top bow No. 3 auxiliary bow .....	1	1	1
176104	Top bow-front .....	1	1	1
193610	Top bow slat assembly-right .....	1	-	-
176102	Top bow slat assembly-right .....	-	1	1
193611	Top bow slat assembly-left .....	1	-	-
176103	Top bow slat assembly-left .....	-	1	1
193506	Top bow support assembly-left .....	-	1	1
193513	Top bow support assembly-left .....	1	-	-
193505	Top bow support assembly-right .....	-	1	1
193512	Top bow support assembly-right .....	1	-	-
176688	Top bow support strap assembly .....	2	2	2
193797	Top door curtain-front left assembly .....	1	-	-
193799	Top door curtain-front left assembly .....	-	1	1
193798	Top door curtain-front right assembly .....	1	-	-
193800	Top door curtain-front right assembly .....	-	1	1
193802	Top door curtain-rear right assembly .....	1	-	-
193804	Top door curtain-rear right assembly .....	-	1	1
193801	Top door curtain-rear left assembly .....	1	-	-
193803	Top door curtain-rear left assembly .....	-	1	1
193805	Top envelope assembly .....	1	-	-
193806	Top envelope assembly .....	-	1	1
164249	Top rear curtain window .....	1	1	1
193808	Top rear seat curtain-right assembly .....	1	-	-
193810	Top rear seat curtain-right assembly .....	-	1	1
193807	Top rear seat curtain-left assembly .....	1	-	-
193809	Top rear seat curtain-left assembly .....	-	1	1
164198	Top support bracket nut .....	2	2	2
164199	Top support bracket nut lock .....	2	2	2
163765	Top to windshield clamp nut .....	2	2	2
175659	Top to windshield clamp bracket assembly-right .....	1	1	1
175660	Top to windshield clamp bracket assembly-left .....	1	1	1
176498	Top to windshield weatherstrip assembly .....	1	1	1

Piece No.	Name	No. Required		
		370	371	381
<b>VENTILATOR</b>				
193814	Ventilator cover assembly .....	1	1	1
137537	Ventilator cover hinge screw .....	2	2	2
3868	Washer (1/4" plain) .....	2	2	2
7104	Nut (1/4"-28 castle) .....	2	2	2
4280	Pin (1/16 x 1/2" cotter) .....	2	2	2
185776	Ventilator cover operating lever .....	1	1	1
7800	Screw (1/4-28 x 1" hex. hd. mach.) .....	2	2	2
5502	Lockwasher (1/4") .....	2	2	2
7004	Nut (1/4"-28) .....	2	2	2
3868	Washer (1/4" plain) .....	2	2	2
118555	Ventilator cover operating lever pin .....	1	1	1
118771	Ventilator cover operating pin roller .....	1	1	1
4280	Pin (1/16 x 1/2" cotter) .....	1	1	1
195684	Ventilator cover operating lever ratchet .....	1	1	1
5792	Ventilator cover operating lever ratchet yoke end pin (5/16" std.) ...	1	1	1
4290	Pin (3/32 x 5/8" cotter) .....	1	1	1
138261	Ventilator cover spring .....	1	1	1
145383	Ventilator hinge adjusting plate assembly-left .....	1	1	1
145384	Ventilator hinge adjusting plate assembly-right .....	1	1	1
187137	Ventilator screen assembly .....	1	1	1
185800	Ventilator side door gutter and operating lever bracket assembly-right	1	1	1
185799	Ventilator side door gutter and operating lever bracket assembly-left.	1	1	1
185798	Ventilator side door and hinge assembly-right .....	1	1	1
185797	Ventilator side door and hinge assembly-left .....	1	1	1
185794	Ventilator side door hinge-right .....	1	1	1
185793	Ventilator side door hinge-left .....	1	1	1
185893	Ventilator side door hinge bumper .....	2	2	2
185809	Ventilator side door hinge pin .....	2	2	2
4690	Pin spring cotter (1/16 x 3/8") .....	2	2	2
199192	Ventilator side door operating lever sleeve .....	2	2	2
5667	Screw No. 10-32 x 5/8" rnd. hd. ....	2	2	2
5500	Lockwasher No. 10 .....	2	2	2
7003	Nut No. 10-32 .....	2	2	2
199170	Ventilator side door operating lever handle .....	2	2	2
5954	Screw No. 10-32 x 5/16" O. H. machine .....	4	4	4
199360	Ventilator side door operating lever plunger .....	2	2	2
5346	Screw No. 10-32 x 7/8" rnd. hd. mach. ....	2	2	2
5500	Lockwasher 3/16" .....	2	2	2
7003	Nut No. 10-32 plain .....	2	2	2
185808	Ventilator side door operating spring .....	2	2	2
199356	Ventilator side screen assembly .....	2	2	2
185814	Ventilator side weatherstrip .....	2	2	2
195686	Ventilator weatherstrip retainer assembly .....	1	1	1
185938	Ventilator weatherstrip .....	1	1	1

### WINDSHIELD

193523	Windshield assembly .....	1	-	-
193342	Windshield assembly .....	-	1	1
193526	Windshield assembly (tonneau) .....	-	-	1
5753	Windshield to body screw (5/16-24 x 1-7/8" hex. hd.) .....	8	8	8
3909	Washer (5/16") .....	8	8	8
5504	Washer (5/16") .....	8	8	8
193653	Windshield cleaner to dash connection tube assembly .....	1	1	1
157688	Windshield cleaner to dash connection tube flared tube connection adapter .....	1	1	1
143360	Windshield cleaner to dash connection tube clip-single .....	1	1	1

Piece No.	Name	No. Required		
		570	571	581
5667	Screw (No. 10-32 x 5/8" rnd. hd. mach.)	1	1	1
5500	Lockwasher (No. 10)	1	1	1
132878	Windshield cleaner hose	1	1	1
141305	Windshield cleaner hose	1	1	1
164153	Windshield cleaner motor--complete	1	1	1
164283	Windshield cleaner motor attaching screw	2	2	2
187835	Windshield cleaner motor shaft washer	1	1	1
164282	Windshield cleaner motor spacer	2	2	2
164155	Windshield cleaner wiper--complete	1	1	1
164277	Windshield cleaner wiper arm screw	1	1	1
164280	Windshield cleaner wiper attaching nut	1	1	1
178504	Windshield to cowl liner	1	1	1
176784	Windshield glass	-	1	1
181019	Windshield glass	1	-	-
193465	Windshield glass (tonneau)	-	-	1
194927	Windshield panel--complete	1	-	-
194928	Windshield panel--complete	-	1	1
194926	Windshield pivot lower screw	2	2	2
194929	Windshield sash and glass	1	-	-
194930	Windshield sash and glass	-	1	1
180756	Windshield sash glass weatherstrip	-	1	1
194920	Windshield stanchion-right	1	-	-
194921	Windshield stanchion-left	1	-	-
194922	Windshield stanchion-right	-	1	1
194923	Windshield stanchion-left	-	1	1
194924	Windshield wing nut-lower	2	2	2
194925	Windshield wing nut-upper	2	2	2

## TRIMMING

156689	Binding (1-1/8") leather colonial grain	x	x	x
176578	Binding leather wire-on colonial grain	x	x	x
176579	Binding leather wire-cordless	x	x	x
29618	Buckram (2 ply 38" wide)	x	x	x
103840	Carpet-grey horse hair (36" wide)	x	x	x
33883	Celluloid-side curtain lights (20 x 36")	x	x	x
29651	Cloth-cotton (36" wide)	x	-	-
182894	Cord (1/4") twisted paper	x	x	x
159187	Cord welt (3/4 x 1/4") colonial leather	x	x	x
161787	Drill white cotton-7 oz. (36" wide)	x	x	x
105025	Drill enameled (50" wide) long grain	x	x	x
195226	Fabric-top material (54" wide) (Burbank 1220 drab)	x	x	x
196391	Fabric-top material (54" wide) (Burbank 1221 drab)	x	x	x
174513	Fabric (54") filled moleskin	x	x	x
170310	Gimp (1/2") leather colonial grain	x	x	x
156692	Gimp (1/2") imitation black colonial leather	x	x	x
175234	Gimp (3/4") leather colonial grain	x	x	x
163172	Kersey felt (45" wide)	x	x	x
159984	Leather-imitation black patent leather finish	x	x	x
156346	Leather-imitation colonial grain	x	x	x
156348	Leather trimming-colonial grain	x	x	x
192303	Muslin-rubber (54" wide)	x	x	x
140935	Paper board (1/2 x 48")	x	x	x
184236	Rubber riser (3/16" half round)	x	x	x
115023	Rubber riser (3/8" half oval)	x	x	x
108123	Rubber tubing (5/16 O. D. x 3/64 wall)	x	x	x
140900	Rubber riser (1/4" half round)	x	x	x
134163	Rubber tubing (3/8 O.D. x 1/16 wall)	x	x	x

Piece No.	Name	No. Required		
		570	571	581
176545	Strip-panel trim tacking .....	X	X	X
29652	Tacks-japanned lace (2 oz.) .....	X	X	X
106964	Tacks-gimp (3 oz.) japanned .....	X	X	X
113812	Tacks-gimp (4 oz.) japanned .....	X	X	X
29657	Tacks-japanned lace (4 oz.) .....	X	X	X
29663	Tacks-trimmers (2-1/2 oz.) japanned .....	X	X	X
29664	Tacks-trimmers (4 oz.) japanned .....	X	X	X
29666	Tacks-trimmers (10 oz.) japanned .....	X	X	X
113789	Tacks-gimp (6 oz.) japanned .....	X	X	X
156681	Thread-"D" spool silk .....	X	X	X
29640	Thread-"EE" No. 18 or Dean and Sherk No. 12-4 .....	X	X	X
127808	Thread-Dean and Sherk No. 20-A silk finish .....	X	X	X
157586	Thread-No. 1201 cord .....	X	X	X
29625	Twine-No. 252 Yazoo .....	-	X	X
29627	Wadding-33" blue sheet No. 532 .....	X	X	X
182687	Wadding-32" white unbleached No. 532 .....	X	X	X
128040	Wadding-33" white sheet .....	-	X	X
62759	Webbing-3" wide jute .....	X	X	X
172470	Wadding-4" white cotton unbleached rolled (5 oz.) .....	X	X	X
148742	Windlace-leather colonial grain .....	X	X	X
159950	Wire screen-16 mesh No. 34 wire (12" wide) .....	X	X	X

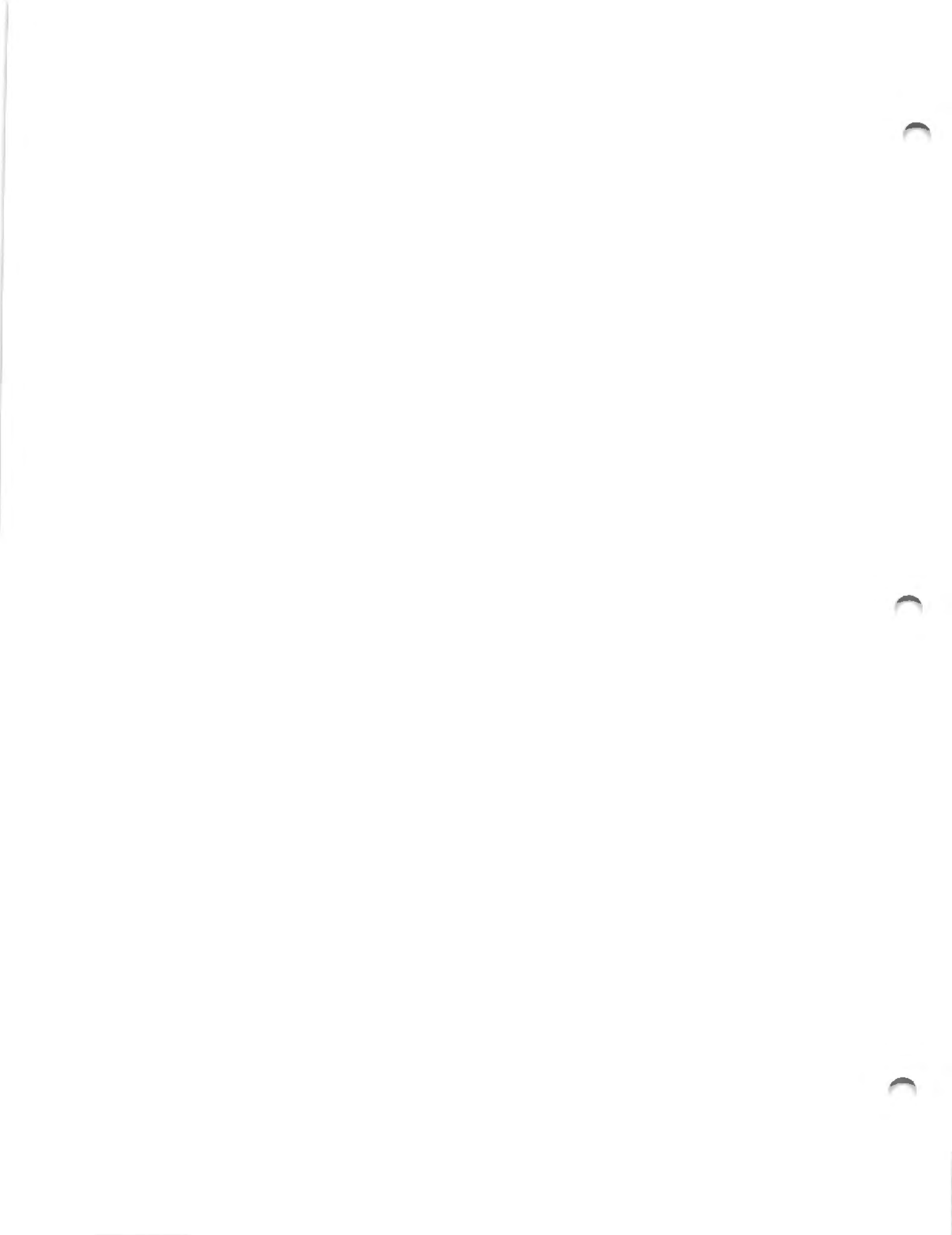

Piece No.	Name	No. Required		
		630	631	641
<b>BODY ATTACHING PARTS</b>				
199771	Body to frame bolt No. 1 carriage bolt 7/16-20 x 3-5/8" skew head ....	2	2	2
5282	Body to frame bolt No. 2 screw 7/16-20 x 3-1/2" hex. hd. mach. ....	2	2	2
5970	Body to frame bolt No. 3 screw 7/16-20 x 5" hex. hd. mach. ....	2	2	2
6283	Body to frame bolt No. 4 screw 7/16-20 x 3-11/16" flat hd. mach. ....	x	x	x
5968	Body to frame bolt No. 4 screw 7/16-20 x 4" flat hd. ....	x	x	x
5671	Body to frame bolt No. 5 screw 7/16-20 x 5-3/8" hex. hd. mach. ....	2	-	-
5969	Body to frame bolt No. 5 screw 7/16-20 x 7-3/8" hex. hd. mach. ....	-	2	2
199770	Body to frame bolt plate .....	2	2	2
182439	Body to frame bolt nut lock .....	4	4	4
131809	Body to frame bolt washer-large washer 7/16" plain special .....	2	2	2
131046	Body to frame bolt washer-small washer 7/16" plain special .....	12	10	10
5508	Body to frame bolt lockwasher 7/16" std. ....	8	8	8
5806	Body to frame bolt lockwasher (Shake proof) .....	2	2	2
7007	Body to frame bolt nut 7/16-20 plain std. ....	8	6	6
206192	Body to frame liner 3/16" thick .....	x	x	x
206193	Body to frame liner 1/4" thick .....	x	x	x
206194	Body to frame liner 5/16" thick .....	x	x	x
167924	Body to frame liner hand brake lever insulator .....	1	1	1
185270	Body hold down bolt bracket liner 3/8" thick .....	x	x	x
185274	Body hold down bolt bracket liner 1/2" thick .....	x	x	x
185273	Body hold down bolt bracket liner 3/16" thick .....	x	x	x
133104	Body hold down bolt bracket liner 1/32" thick .....	x	x	x
193930	Body to frame liner 3/16" thick .....	x	-	-
193931	Body to frame liner 3/16" thick .....	-	x	x

### BODY WIRING (Miscellaneous)

33287	Body feed cable terminal 13/64" eye .....	1	1	1
36111	Body feed cable terminal insulator .....	1	1	1
159085	Body ground cable terminal 5/16" eye .....	1	1	1
176078	Body wiring cable clip .....	x	x	x
194286	Body wiring cable clip .....	2	2	2

### BONNET DASH LINER

206652	Bonnet dash liner .....	2	2	2
187260	Bonnet dash liner hook .....	2	2	2
3866	Washer 3/16" "N" std. ....	2	2	2
7002	Nut No. 8-32 .....	2	2	2

### DOORS

All doors must be adjusted to each respective body. To obtain satisfactory replacement of doors, it is advisable to return the damaged door to be repaired, if possible. If this cannot be done, the customer assumes the responsibility of the new door being a satisfactory fit.

Specify on all orders the upholstery material, color and striping.

195485	Door trimmed assembly front right .....	1	1	1
195483	Door trimmed assembly front left .....	1	1	1
195489	Door trimmed assembly rear right .....	1	1	1
195487	Door trimmed assembly rear left .....	1	1	1



Piece No.	Name	No. Required		
		630	631	641
<b>DOOR PART</b>				
111671	Door bumper .....	8	8	8
185143	Door check-left .....	1	1	1
185142	Door check-right .....	1	1	1
177021	Door check escutcheon plate .....	2	2	2
185235	Door check stop plate assembly left .....	1	1	1
185233	Door check stop plate assembly right .....	1	1	1
180704	Door curtain carrier rod left .....	2	-	-
176125	Door curtain carrier rod left .....	-	2	2
180703	Door curtain carrier rod right .....	2	-	-
176124	Door curtain carrier rod right .....	-	2	2
165759	Door curtain carrier socket .....	4	4	4
119226	Door dove tail bumper .....	8	8	8
119245	Door dove tail bumper clip .....	8	8	8
119297	Door dove tail casing .....	4	4	4
119296	Door dove tail female retainer .....	4	4	4
118500	Door hinge .....	8	8	8
8029	Screw No. 12-24 x 5/16" oval hd. ....	32	32	32
119298	Door dove tail male .....	4	4	4
165021	Door lock .....	4	4	4
173952	Door lock handle .....	4	-	-
176788	Door lock handle .....	-	4	4
165014	Door lock lever assembly right .....	2	2	2
165015	Door lock lever assembly left .....	2	2	2
168020	Door lock lever handle nut .....	4	4	4
174113	Door lock lever handle right .....	2	2	2
174114	Door lock lever handle left .....	2	2	2
174115	Door lock lever and link assembly front right .....	1	1	1
174116	Door lock lever and link assembly front left .....	1	1	1
173814	Door lock striker right .....	2	2	2
174223	Door lock striker left .....	2	2	2
193656	Door scuff plate front left .....	1	1	1
193655	Door scuff plate front right .....	1	1	1
193642	Door scuff plate rear right .....	1	1	1
193643	Door scuff plate rear left .....	1	1	1

**FASTENER**

195664	Fastener eyelet-top envelope .....	x	x	x
161792	Fastener eyelet plate-top envelope .....	x	x	x
161794	Fastener screw post-rear seat back rail .....	x	x	x
193200	Snap fastener machine screw post-carpet front floor .....	x	x	x
115268	Snap fastener mach. screw post single-top curtain .....	x	x	x
116554	Snap fastener mach. screw post double-top curtain .....	x	x	x
139157	Snap fastener rivet post female-door pocket .....	x	x	x
139160	Snap fastener rivet post male long-door pocket .....	x	x	x
139157	Snap fastener rivet post female-top curtain .....	x	x	x
139158	Snap fastener rivet post male-top curtain .....	x	x	x
148637	Snap fastener rivet post male-top curtain .....	x	x	x
193199	Snap fastener rivet post-female carpet front floor .....	x	x	x
193201	Snap fastener screw post-carpet front floor .....	x	x	x
193201	Snap fastener screw post-carpet rear floor .....	x	x	x
159060	Snap fastener screw stud (Self tapping)-carpet front floor .....	x	x	x
112058	Snap fastener screw post-top curtain .....	x	x	x
139150	Snap fastener socket female-door pocket .....	x	x	x
76926	Snap fastener socket female-top curtain .....	x	x	x
139150	Snap fastener socket female-top curtain .....	x	x	x
115799	Snap fastener socket-carpet front floor .....	x	x	x
115799	Snap fastener socket-carpet rear floor .....	x	x	x
115798	Snap fastener socket ring-carpet front floor .....	x	x	x
115798	Snap fastener socket ring-carpet rear floor .....	x	x	x

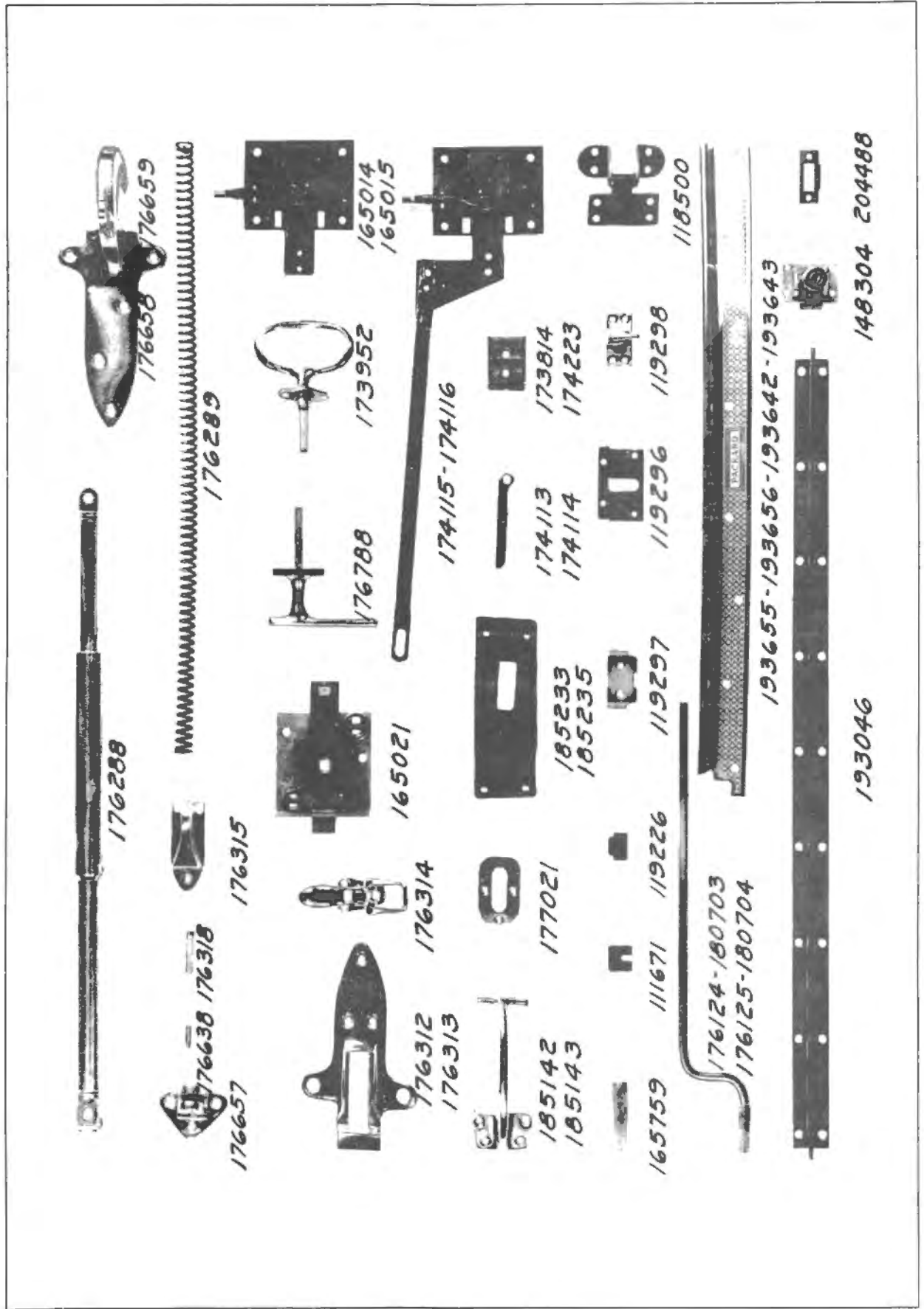



Piece No.	Name	No. Required		
		630	631	641
139159	Snap fastener socket-door panel .....	x	x	x
76925	Snap fastener socket male-short prong .....	x	x	x
102150	Snap fastener socket male-long prong .....	x	x	x
139159	Snap fastener socket top curtain .....	x	x	x
116446	Snap fastener wood screw post double-top curtain .....	x	x	x
106755	Snap fastener wood screw post single-top curtain .....	x	x	x

## FLOOR BOARD

206476	Floor board front assembly .....	-	1	1
206477	Floor board front assembly .....	1	-	-
206481	Floor board front felt front .....	1	1	1
206480	Floor board front felt center .....	1	1	1
206479	Floor board front felt rear .....	1	1	1
206482	Floor board front felt side .....	-	2	2
206483	Floor board front felt side .....	2	-	-
196000	Floor board rear assembly .....	1	-	-
8214	Screw 1/4-28 x 3/4" flat hd. ....	2	2	2

## FLOOR CARPET

Specify color and type of binding when ordering carpet

204627	Floor carpet front assembly .....	-	1	1
204628	Floor carpet front assembly .....	1	-	-
204636	Floor carpet rear assembly .....	1	-	-
212224	Floor carpet rear assembly .....	-	1	1

## FOLDING ARM REST

211292	Folding arm rest trimmed assembly .....	1	-	-
211290	Folding arm rest trimmed assembly .....	-	1	1
187134	Folding arm rest cushion .....	-	1	1
211296	Folding arm rest cushion .....	1	-	-
211259	Folding arm rest spring .....	1	-	-
211247	Folding arm rest spring .....	-	1	1
187544	Folding arm rest support bracket assembly .....	1	-	-
211297	Folding arm rest support bracket assembly .....	-	1	1
171580	Screw No. 10-32 x 5/8" flat hd. ....	6	6	6
7824	Screw 1/4-28 x 5/8" hex. hd. ....	4	4	4
5502	Lockwasher 1/4" std. ....	4	4	4
7004	Nut 1/4-28 .....	4	4	4

## FOLDING SEAT

193961	Folding seat trimmed assembly .....	2	-	-
187498	Folding seat untrimmed assembly .....	2	-	-
169102	Folding seat back untrimmed assembly .....	2	-	-
167945	Folding seat back to seat frame screw .....	4	-	-
172294	Folding seat cushion spring .....	2	-	-
193826	Folding seat floor carpet assembly .....	2	-	-
171692	Folding seat frame assembly .....	2	-	-
5580	Screw No. 10-32 x 1" flat hd. ....	16	-	-
5229	Screw 1/4-28 x 1-3/8" flat hd. ....	8	-	-
8220	Screw 1/4-28 x 1-1/2" flat hd. ....	8	-	-
7003	Nut No. 10-32 .....	16	-	-
7004	Nut 1/4-28 .....	16	-	-
3867	Washer 3/16" special .....	4	-	-
171698	Folding seat frame side left .....	2	-	-
171703	Folding seat frame side right .....	2	-	-
184024	Folding seat handle .....	2	-	-
100100	Folding seat pivot pin .....	4	-	-

Piece No.	Name	No. Required		
		630	631	641
187421	Folding seat pivot pin retainer .....	2	-	-
187410	Folding seat support left .....	2	-	-
187411	Folding seat support right .....	2	-	-
130869	Folding seat support to seat frame screw .....	4	-	-
7006	Nut 3/8-24 .....	4	-	-
5506	Lockwasher 3/8" .....	4	-	-

## FOOT REST

163745	Foot rest assembly .....	-	1	1
163743	Foot rest assembly .....	1	-	-
166444	Foot rest bar .....	1	-	-
166445	Foot rest bar end support right assembly .....	1	-	-
166442	Foot rest bar end support right assembly .....	-	1	1
166446	Foot rest bar end support left assembly .....	1	-	-
166443	Foot rest bar end support left assembly .....	-	1	1
147963	Foot rest pivot stud .....	2	-	-

## FRONT SEAT

193603	Front seat-left-back spring .....	1	1	1
193602	Front seat-right-back spring .....	1	1	1
199641	Front seat compartment bottom battery cover .....	1	1	1
196311	Front seat compartment bottom battery cover clamp .....	2	2	2
7906	Screw 1/4-28 x 3/4" rnd. hd. ....	2	2	2
199045	Front seat compartment bottom battery cover clamp screw clinch nut 1/4-28 thd. ....	2	2	2
199643	Front seat compartment bottom battery cover gasket .....	1	1	1
193861	Front seat-left-cushion assembly .....	1	1	1
193863	Front seat-right-cushion assembly .....	1	1	1
181141	Front seat cushion dowel female .....	4	4	4
181036	Front seat cushion dowel male .....	4	4	4
183259	Front seat-right-cushion spring .....	1	1	1
183280	Front seat-left-cushion spring .....	1	1	1
199722	Front seat-left-locking spring .....	1	1	1
199718	Front seat-left-operating spring .....	1	1	1
180845	Front seat-left-support bar assembly .....	1	1	1

## HAND BRAKE CUTOUT COVER

204455	Hand brake lever cutout cover .....	1	1	1
--------	-------------------------------------	---	---	---

## PANEL

204454	Panel cowl assembly .....	1	1	1
206500	Panel dash assembly .....	1	1	1
206503	Panel dash cover assembly .....	1	1	1
206492	Panel dash inter liner .....	1	1	1
206493	Panel dash liner .....	1	1	1
193400	Panel-door front right assembly .....	1	1	1
193401	Panel-door front left assembly .....	1	1	1
193402	Panel-door rear right assembly .....	1	1	1
193403	Panel-door rear left assembly .....	1	1	1

## REAR SEAT

211262	Rear seat back spring-right .....	1	-	-
211263	Rear seat back spring-left .....	1	-	-
211245	Rear seat back spring-right .....	-	1	1

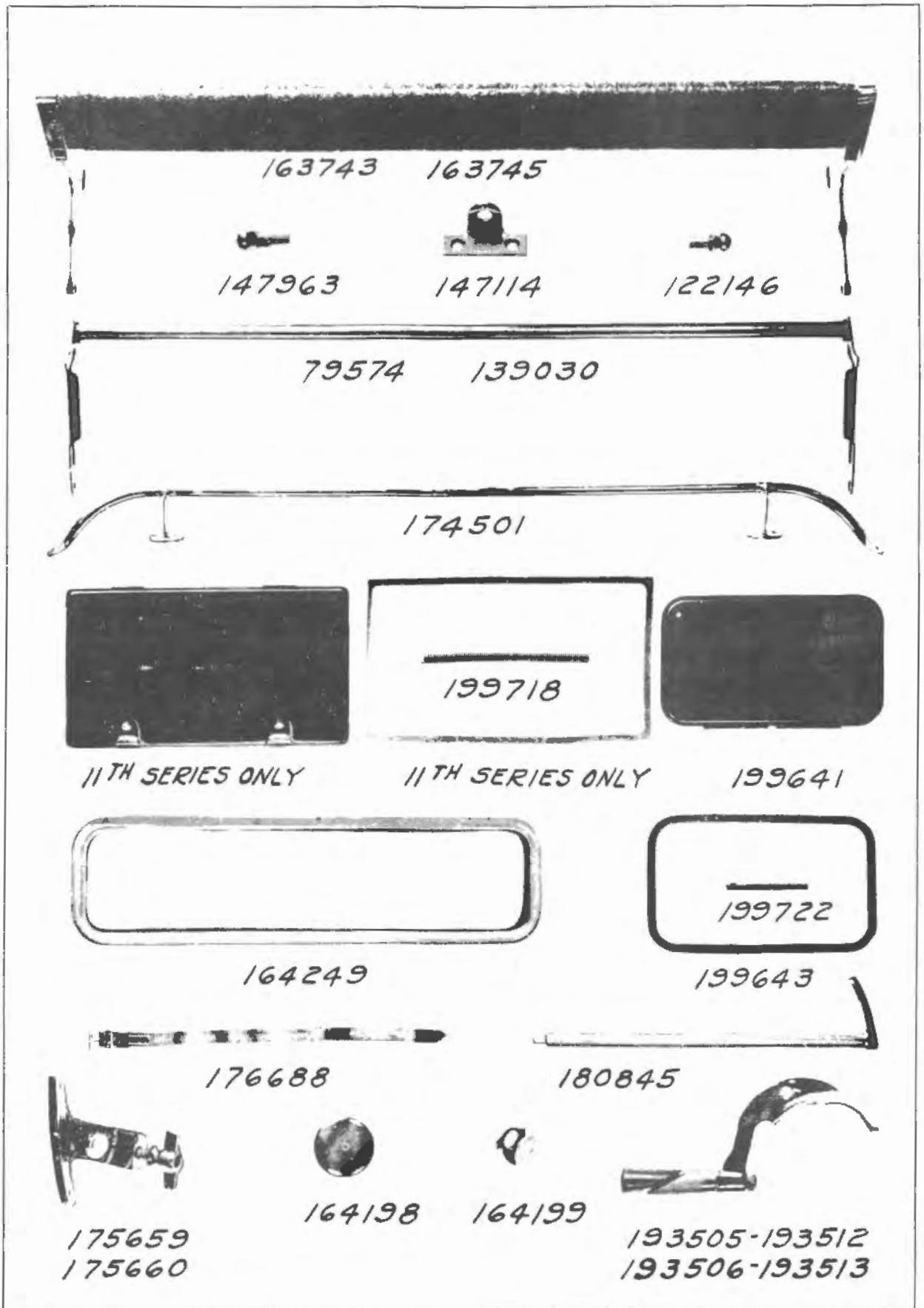





Piece No.	Name	No. Required		
		630	631	641
211246	Rear seat back spring-left .....	-	1	1
193875	Rear seat cushion assembly .....	1	-	-
204195	Rear seat cushion assembly .....	-	1	1
181141	Rear seat cushion dowel female .....	2	2	2
181036	Rear seat cushion dowel male .....	2	2	2
3877	Washer 3/8" "N" std. ....	2	2	2
187522	Rear seat cushion spring .....	1	-	-
204257	Rear seat cushion spring .....	-	1	1

## REAR VIEW MIRROR

176816	Rear view mirror assembly .....	1	1	1
191368	Rear view mirror glass .....	1	1	1
5589	Screw No. 10-32 x 1/2" rnd. hd. ....	2	2	2

## ROBE RAIL

174501	Robe rail assembly .....	1	1	-
--------	--------------------------	---	---	---

## SPOTLIGHT

206633	Spotlight assembly .....	1	1	1
102507	Spotlight cable grommet .....	1	1	1
206636	Spotlight bracket .....	1	1	1

## TONNEAU COWL

178705	Tonneau cowl trimmed assembly .....	-	-	1
176786	Tonneau cowl bumper .....	-	-	2
176314	Tonneau cowl clamp .....	-	-	2
6264	Screw No. 10-32 x 1-3/8" oval hd. ....	-	-	6
176315	Tonneau cowl clamp bracket and bumper retainer .....	-	-	2
176288	Tonneau cowl counterbalance assembly .....	-	-	2
176638	Tonneau cowl counterbalance screw lower .....	-	-	2
177006	Tonneau cowl counterbalance screw upper .....	-	-	2
176657	Tonneau cowl counterbalance bracket lower .....	-	-	2
176289	Tonneau cowl counterbalance spring .....	-	-	2
176312	Tonneau cowl hinge female right .....	-	-	1
176313	Tonneau cowl hinge female left .....	-	-	1
5595	Screw 3/8-24 x 1-3/4" hex. hd. ....	-	-	4
5506	Lockwasher 3/8" std. ....	-	-	4
176658	Tonneau cowl hinge male right .....	-	-	1
176659	Tonneau cowl hinge male left .....	-	-	1
176318	Tonneau cowl hinge screw .....	-	-	2

## TONNEAU LIGHT

180645	Tonneau light assembly .....	2	2	2
102590	Tonneau light bulb 7 V 3 CP G-6 single contact .....	2	2	2
180646	Tonneau light glass and rim .....	2	2	2
176778	Tonneau light to ground cable assembly .....	2	2	2
180647	Tonneau light reflector .....	2	2	2
199732	Tonneau light switch .....	2	2	2
127502	Tonneau light switch plunger plate .....	2	2	2

Piece No.	Name	No. Required		
		630	631	641
<b>TONNEAU VENTILATOR</b>				
176296	Tonneau ventilator cover assembly left .....	-	-	1
176650	Tonneau ventilator cover assembly right .....	-	-	1
176301	Tonneau ventilator cover spring .....	-	-	2
204418	Tonneau ventilator finishing plate left .....	-	-	1
204417	Tonneau ventilator finishing plate right .....	-	-	1
5766	Screw No. 6-40 x 3/8" oval hd. ....	-	-	6
176304	Tonneau ventilator knob .....	-	-	2
5500	Lockwasher 3/16" std. ....	-	-	2
7003	Nut No. 10-32 .....	-	-	2
204419	Tonneau ventilator screen .....	-	-	2

### TOOL COMPARTMENT

200527	Tool compartment door assembly .....	-	1	1
139046	Tool compartment door hinge .....	-	1	1
148304	Tool compartment door lock .....	-	1	1
204488	Tool compartment door lock striker .....	-	1	1

### TOP

193612	Top assembly .....	1	-	-
176100	Top assembly .....	-	1	1
176105	Top bow No. 1 .....	-	1	1
176133	Top bow No. 1 .....	1	-	-
180326	Top bow No. 2 .....	1	-	-
176106	Top bow No. 2 .....	-	1	1
193496	Top bow No. 3 .....	1	-	-
193497	Top bow No. 3 .....	-	1	1
193450	Top bow No. 3 auxiliary bow .....	1	1	1
176104	Top bow front .....	1	1	1
193610	Top bow slat assembly right .....	1	-	-
176102	Top bow slat assembly right .....	-	1	1
193611	Top bow slat assembly left .....	1	-	-
176103	Top bow slat assembly left .....	-	1	1
193506	Top bow support assembly left .....	-	1	1
193513	Top bow support assembly left .....	1	-	-
193505	Top bow support assembly right .....	-	1	1
193512	Top bow support assembly right .....	1	-	-
176799	Top bow support nut .....	2	2	2
176688	Top bow support strap assembly .....	2	2	2
211963	Top door curtain front left assembly .....	1	-	-
211965	Top door curtain front left assembly .....	-	1	1
211964	Top door curtain front right assembly .....	1	-	-
211966	Top door curtain front right assembly .....	-	1	1
193802	Top door curtain rear right assembly .....	1	-	-
193804	Top door curtain rear right assembly .....	-	1	1
193801	Top door curtain rear left assembly .....	1	-	-
193803	Top door curtain rear left assembly .....	-	1	1
193805	Top envelope assembly .....	1	-	-
193806	Top envelope assembly .....	-	1	1
164249	Top rear curtain window .....	1	1	1
193808	Top rear seat curtain right assembly .....	1	-	-
193810	Top rear seat curtain right assembly .....	-	1	1
193807	Top rear seat curtain left assembly .....	1	-	-
193809	Top rear seat curtain left assembly .....	-	1	1
164198	Top support bracket nut .....	2	2	2
164199	Top support bracket nut-lock .....	2	2	2
175659	Top to windshield clamp bracket assembly right .....	1	1	1

Piece No.	Name	No. Required		
		650	651	641
175660	Top to windshield clamp bracket assembly left .....	1	1	1
5752	Screw 1/4-28 x 1-5/32" oval hd. ....	4	4	4
3868	Washer 1/4" "N" std. ....	4	4	4
7004	Nut 1/4-28 .....	4	4	4

VENTILATOR

193814	Ventilator cover assembly .....	1	1	1
137537	Ventilator cover hinge screw .....	2	2	2
3868	Washer 1/4" "N" std. ....	2	2	2
7104	Nut 1/4-28 castle .....	2	2	2
4280	Pin 1/16 x 1/2" cotter .....	2	2	2
185776	Ventilator cover operating lever .....	1	1	1
7800	Screw 1/4-28 x 1" hex. hd. ....	2	2	2
5502	Lockwasher 1/4" std. ....	2	2	2
7004	Nut 1/4-28 .....	2	2	2
3868	Washer 1/4" "N" std. ....	2	2	2
118555	Ventilator cover operating lever pin .....	1	1	1
118771	Ventilator cover operating pin roller .....	1	1	1
4280	Pin 1/16 x 1/2" cotter .....	1	1	1
195684	Ventilator cover operating lever ratchet .....	1	1	1
5792	Ventilator cover operating lever ratchet yoke end pin 5/16" .....	1	1	1
4290	Pin 3/32 x 5/8" cotter .....	1	1	1
138261	Ventilator cover spring .....	1	1	1
145383	Ventilator hinge adjusting plate assembly left .....	1	1	1
145384	Ventilator hinge adjusting plate assembly right .....	1	1	1
187137	Ventilator screen assembly .....	1	1	1
8011	Screw No. 8-32 x 7/16" oval hd. ....	6	6	6
3774	Lockwasher No. 8 std. ....	6	6	6
7002	Nut No. 8-32 .....	6	6	6
185800	Ventilator side door gutter and operating lever bracket assembly right .....	1	1	1
185799	Ventilator side door gutter and operating lever bracket assembly left .....	1	1	1
185798	Ventilator side door and hinge assembly right .....	1	1	1
185797	Ventilator side door and hinge assembly left .....	1	1	1
185893	Ventilator side door hinge bumper .....	2	2	2
185809	Ventilator side door hinge pin .....	2	2	2
4690	Pin spring cotter 1/16 x 3/8" .....	2	2	2
199170	Ventilator side door operating lever handle .....	2	2	2
5954	Screw No. 10-32 x 5/16" oval hd. ....	4	4	4
199360	Ventilator side door operating lever plunger .....	2	2	2
5346	Screw No. 10-32 x 7/8" rnd. hd. ....	2	2	2
5500	Lockwasher No. 10 .....	2	2	2
7003	Nut No. 10-32 .....	2	2	2
199192	Ventilator side door operating lever sleeve .....	2	2	2
5667	Screw No. 10-32 x 5/8" rnd. hd. ....	2	2	2
5500	Lockwasher No. 10 .....	2	2	2
7003	Nut No. 10-32 .....	2	2	2
185808	Ventilator side door operating spring .....	2	2	2
185814	Ventilator side weatherstrip .....	2	2	2
185938	Ventilator weatherstrip .....	1	1	1

WINDSHIELD

204992	Windshield assembly .....	1	-	-
204993	Windshield assembly .....	-	1	1
204960	Windshield assembly tonneau .....	-	-	1
5753	Windshield to body screw 5/16-24 x 1-7/8" hex. hd. ....	8	8	8
3909	Washer 5/16" special .....	8	8	8

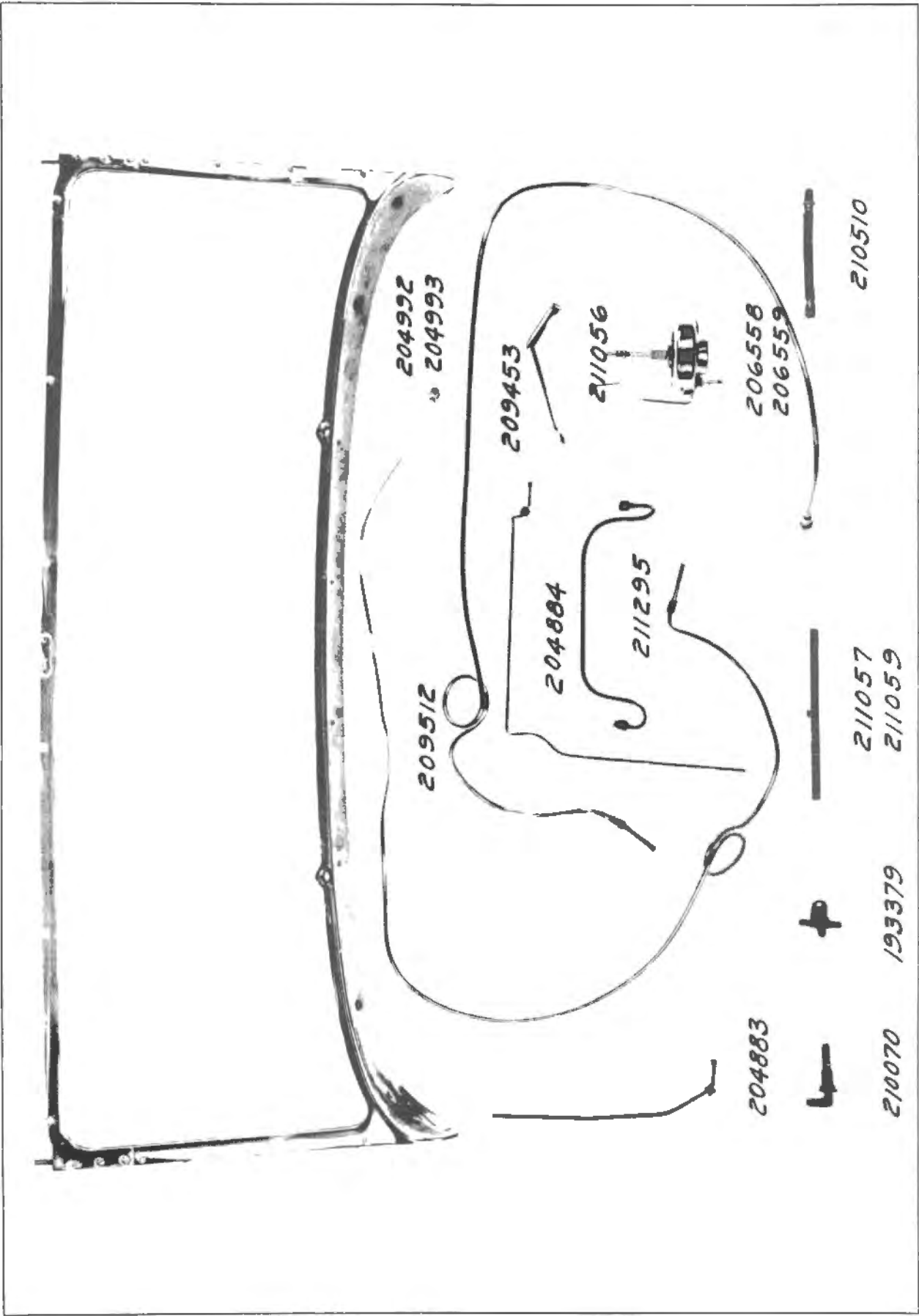

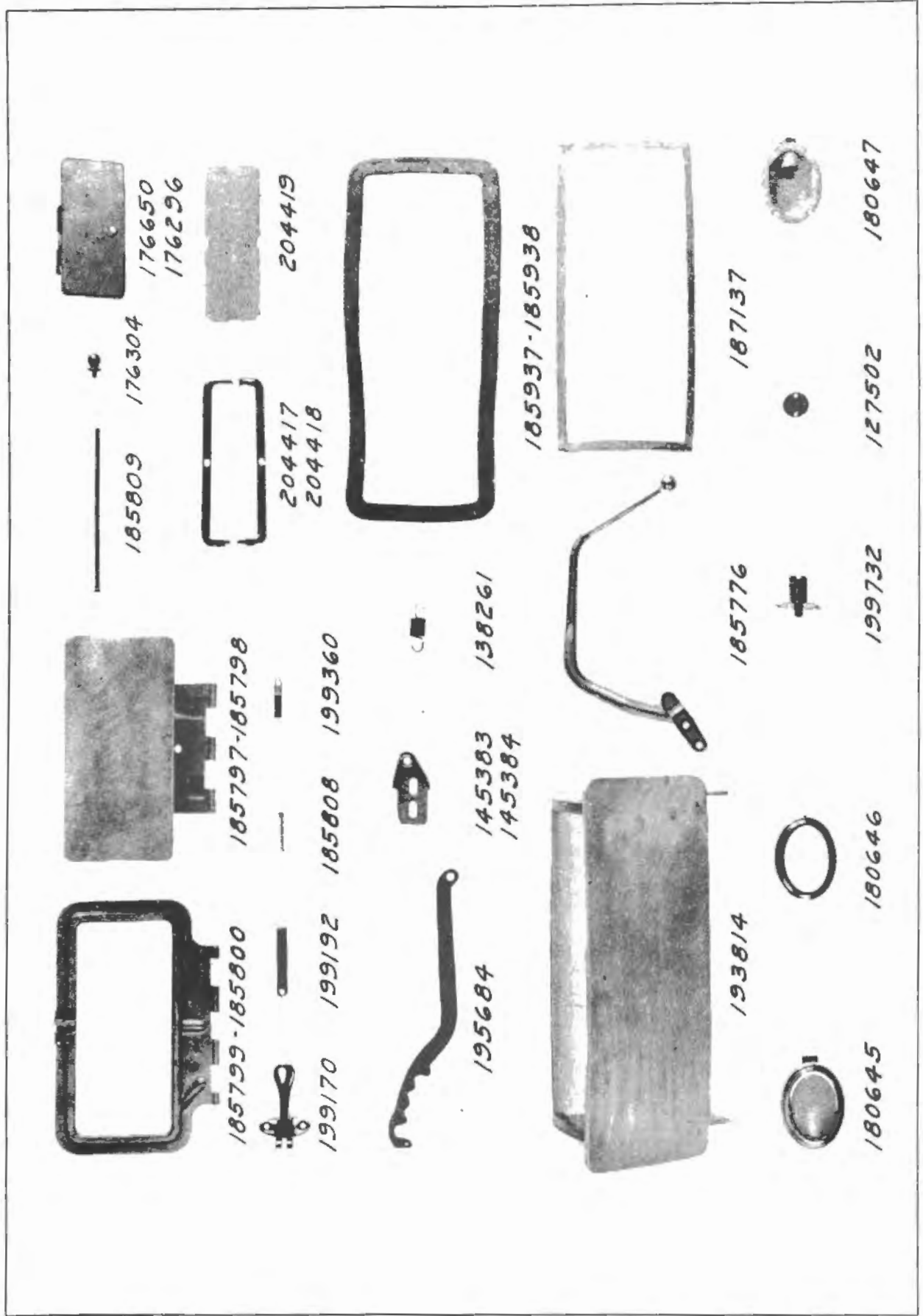

Piece No.	Name	No. Required		
		630	631	641
5504	Lockwasher 5/16" std. ....	8	8	8
193379	Windshield cleaner dash connection ....	1	1	1
173133	Screw No. 10 x 1/2" flat hd. ....	2	2	2
204884	Windshield cleaner to dash connection tube assembly right ....	1	1	1
204883	Windshield cleaner to dash connection tube assembly left ....	1	1	1
183463	Windshield cleaner to dash connection tube union nut 3/16" ....	2	2	2
157688	Windshield cleaner to dash connection tube adapter 3/16" ....	2	2	2
143360	Windshield cleaner to dash connection tube clip single ....	1	1	1
199787	Screw No. 8 x 1/2" (Parker-Kalon) binding head (Pilot point) ....	1	1	1
211295	Windshield cleaner dash connection vacuum supply tube assembly ....	1	1	1
157477	Windshield cleaner dash connection vacuum supply tube union nut ....	2	2	2
177851	Windshield cleaner dash connection vacuum supply tube (flared tube connection) adapter ....	2	2	2
140007	Windshield cleaner hose ....	2	2	2
206558	Windshield cleaner motor complete right ....	1	1	1
206559	Windshield cleaner motor complete left ....	1	1	1
206834	Windshield cleaner motor attaching nut ....	2	2	2
206040	Windshield cleaner motor attaching washer ....	2	2	2
206189	Windshield cleaner motor operating lever knob ....	2	2	2
210070	Windshield cleaner vacuum pump dash connection ....	1	1	1
7007	Nut 7/16-20 hex. ....	1	1	1
5806	Lockwasher 7/16" Shakeproof ....	1	1	1
3883	Washer 7/16" plain ....	1	1	1
209512	Windshield cleaner vacuum pump to dash connection tube assembly ....	1	1	1
6261	Nut 1/4" flared tube inverted ....	1	1	1
6279	Elbow 1/4" flared tube inverted ....	1	1	1
209578	Clip style No. 14 ....	1	1	1
167261	Screw No. 10 (.187) x 3/8" (Parker-Kalon) ....	1	1	1
209453	Windshield cleaner vacuum pump to manifold tube assembly ....	1	1	1
6262	Nut 5/16" flared tube inverted ....	1	1	1
6273	Elbow 5/16" flared tube inverted ....	1	1	1
6271	Tee 5/16" flared tube inverted ....	1	1	1
5867	Union nut 5/16" flared tube ....	1	1	1
209579	Windshield cleaner vacuum pump tube clip ....	2	2	2
211059	Windshield cleaner wiper ....	2	-	-
211057	Windshield cleaner wiper ....	-	2	2
211056	Windshield cleaner wiper arm ....	2	2	2
115268	Windshield curtain fastener ....	6	6	6
117569	Windshield curtain fastener ....	10	10	10
5780	Windshield side screw long ....	4	4	4
6303	Windshield side screw short ....	4	4	4
206568	Windshield to cowl liner ....	1	1	1
193465	Windshield glass tonneau ....	-	1	1
206020	Windshield glass ....	1	1	1

### TRIMMING

To avoid errors due to difference in texture and shade, please furnish sample when ordering trimming material.

200924	Assembly-cowl trim panel-left (Specify set number) ....	1	1	1
200925	Assembly-cowl trim panel-right (Specify set number) ....	1	1	1
192689	Assembly-door trimming-front left (Specify set number) ....	1	1	1
192691	Assembly-door trimming-front right (Specify set number) ....	1	1	1
192693	Assembly-door trimming-rear left (Specify set number) ....	1	1	1
192695	Assembly-door trimming-rear right (Specify set number) ....	1	1	1
156596	Binding lace 7/16" (Specify set number) ....	x	x	x
176576	Binding leather wire on colonial grain (Specify set number) ....	x	x	x
176579	Binding leather wire on (cordless) (Specify set number) ....	x	x	x
29218	Buckram 2 ply 38" wide ....	x	x	x

Piece No.	Name	No. Required		
		630	631	641
166480	Button mould No. 22 ligne upholsters shell .....	42	36	36
166479	Button mould No. 22 ligne upholsters filler .....	42	36	36
166478	Button mould No. 22 ligne upholsters eye .....	42	36	36
184555	Button leather covered upholsters tufting (Specify set number) .....	42	36	36
200996	Carpet rubber set 36" wide (Specify set number) .....	-	x	x
200995	Carpet rubber set 36" wide (Specify set number) .....	x	x	x
33883	Celluloid side curtain lights 20 x 36" .....	x	x	x
29651	Cloth cotton 36" wide .....	x	x	x
179401	Cord welt enameled drill .....	x	x	x
195209	Cord welt enameled drill .....	x	x	x
159187	Cord welt 3/4 x 1/4 colonial leather (Specify set number) .....	x	x	x
161787	Drill white cotton 7 oz. 36" wide .....	x	x	x
105025	Drill enameled 50" wide long grain .....	x	x	x
200525	Duck black double filled 1.35-50" .....	x	x	x
200467	Fabric top material 54" wide .....	x	x	x
174513	Fabric 54" filled mole skin .....	x	x	x
156692	Gimp 1/2" imitation black colonial leather .....	x	x	x
175234	Gimp 3/4" leather colonial grain .....	x	x	x
170310	Gimp 1/2" leather colonial grain .....	x	x	x
214054	Hair interlaced 52" wide .....	x	x	x
172326	Hair and wadding batts 4" - 6 oz. ....	-	x	x
172327	Hair and wadding batts 5-1/4" - 10 oz. ....	-	x	x
163380	Hair pad 36" wide 1/4" all cow hair burlap center .....	x	x	x
127473	Hair Wilson and Co. super bovine grey or its equivalent .....	x	x	x
156346	Leather imitation colonial grain (Specify set number) .....	x	x	x
156348	Leather trimming colonial grain (Specify set number) .....	x	x	x
192303	Muslin rubber 54" wide .....	x	x	x
140935	Paper board 1/2 x 48" .....	x	x	x
184236	Rubber riser 3/16" half round .....	x	x	x
115023	Rubber riser 3/8" half oval .....	x	x	x
140900	Rubber riser 1/4" half round .....	x	x	x
108123	Rubber tubing 5/16" O.D. x 3/64" wall .....	x	x	x
134163	Rubber tubing 3/8" O.D. x 1/16" wall .....	x	x	x
29652	Tacks-japanned lace 2 oz. ....	x	x	x
106964	Tacks-gimp 3 oz. japanned .....	x	x	x
113812	Tacks-gimp 4 oz. japanned .....	x	x	x
29657	Tacks-japanned lace 4 oz. ....	x	x	x
211930	Tacks trimmers 2-1/2 oz. galvanized .....	x	x	x
211931	Tacks trimmers 4 oz. galvanized .....	x	x	x
211932	Tacks trimmers 10 oz. galvanized .....	x	x	x
29663	Tacks trimmers 2-1/2 oz. japanned .....	x	x	x
29664	Tacks trimmers 4 oz. japanned .....	x	x	x
29666	Tacks trimmers 10 oz. japanned .....	x	x	x
113789	Tacks gimp 6 oz. japanned .....	x	x	x
29640	Thread "EE" No. 18 or Dean and Sheck No. 12-4 .....	x	x	x
127808	Thread Dean and Sheck No. 20-A silk finish .....	x	x	x
157586	Thread No. 1201 cord .....	x	x	x
29625	Twine No. 252 Yazoo .....	-	x	x
192208	Wadding 3" white cotton rolled 3-1/2 oz. ....	x	x	x
29627	Wadding 33" blue sheet No. 532 .....	x	x	x
182687	Wadding 32" white unbleached No. 532 .....	x	x	x
192209	Wadding 5" white cotton rolled 6 oz. ....	x	x	x
128040	Wadding 33" white sheet .....	x	x	x
62759	Webbing 3" wide jute .....	x	x	x
172470	Wadding 4" white cotton unbleached rolled 5 oz. ....	x	x	x
148742	Windlace leather colonial grain (Specify set number) .....	x	x	x



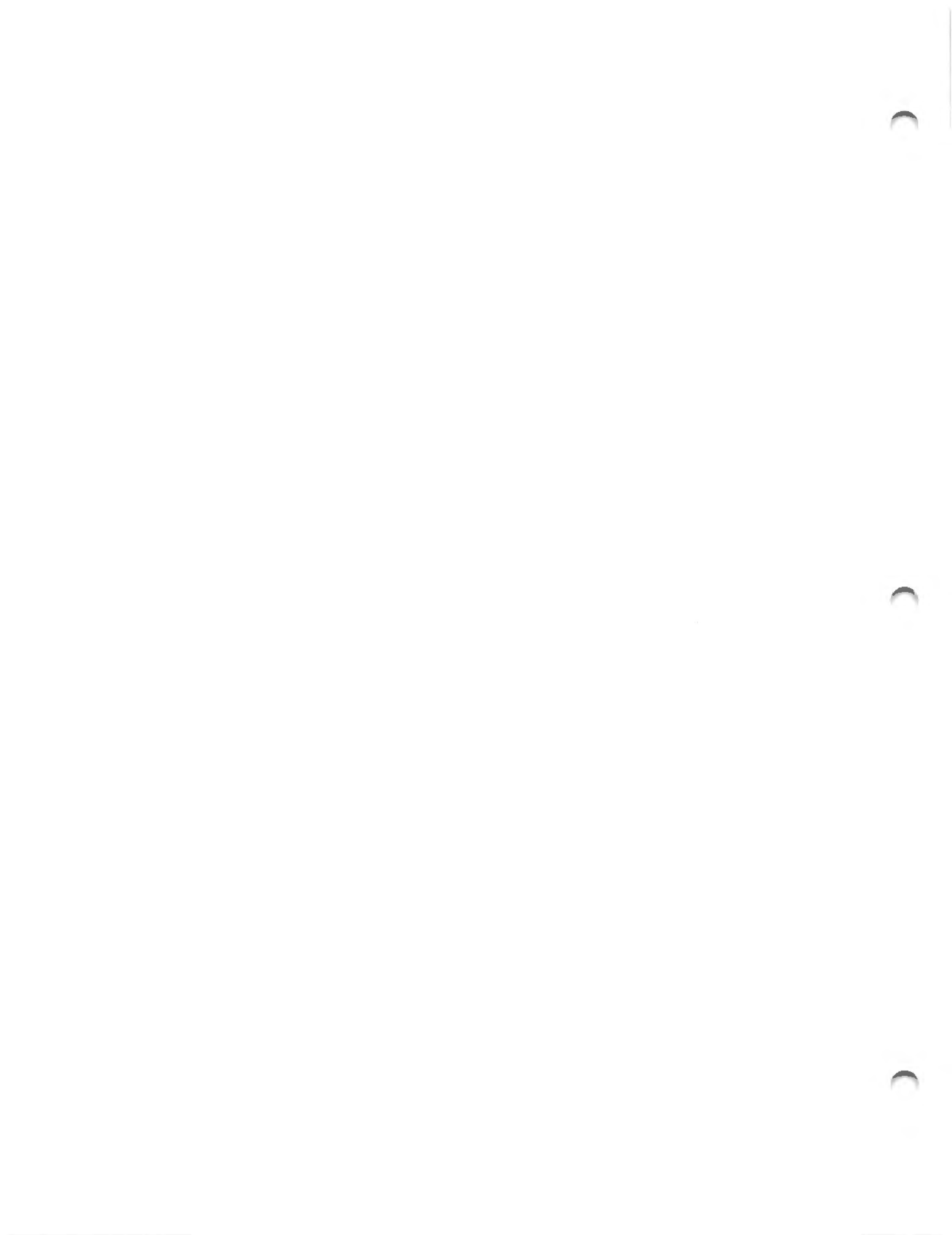

Piece No.	Name	No. Required		
		730	731	741
<b>BODY ATTACHING PARTS</b>				
6069	Body to frame bolt No. 1 carriage bolt common 7/16-20 x 3-5/8" .....	2	2	2
199771	Body to frame bolt No. 1 carriage bolt 7/16-20 x 3-5/8" skew head ....	2	2	2
5282	Body to frame bolt No. 2 screw 7/16-20 x 3-1/2" hex. hd. mach. ....	2	2	2
5970	Body to frame bolt No. 3 screw 7/16-20 x 5" hex. hd. mach. ....	2	2	2
6283	Body to frame bolt No. 4 screw 7/16-20 x 3-11/16" flat hd. mach. ....	x	x	x
5968	Body to frame bolt No. 4 screw 7/16-20 x 4" flat hd. ....	x	x	x
5671	Body to frame bolt No. 5 screw 7/16-20 x 5-3/8" hex. hd. mach. ....	2	-	-
5969	Body to frame bolt No. 5 screw 7/16-20 x 7-3/8" hex. hd. mach. ....	-	2	2
199770	Body to frame bolt plate .....	2	2	2
199705	Body to frame bolt plate .....	2	2	2
182439	Body to frame bolt nut lock .....	4	4	4
131809	Body to frame bolt washer-large washer 7/16" plain special .....	2	2	2
131046	Body to frame bolt washer-small washer 7/16" plain special .....	12	10	10
5508	Body to frame bolt lockwasher 7/16" std. ....	8	8	8
5806	Body to frame bolt lockwasher (Shakeproof) .....	2	2	2
7007	Body to frame bolt nut 7/16-20 plain std. ....	6	6	6
206192	Body to frame liner 3/16" thick .....	x	x	x
206193	Body to frame liner 1/4" thick .....	x	x	x
206194	Body to frame liner 5/16" thick .....	x	x	x
167924	Body to frame liner hand brake lever insulator .....	1	1	1
185270	Body hold down bolt bracket liner 3/8" thick .....	x	x	x
185274	Body hold down bolt bracket liner 1/2" thick .....	x	x	x
185273	Body holdddown bolt bracket liner 3/16" thick .....	x	x	x
133104	Body hold down bolt bracket liner 1/32" thick .....	x	x	x
193930	Body to frame liner 3/16" thick .....	x	-	-
193931	Body to frame liner 3/16" thick .....	-	x	x

### BODY WIRING (Miscellaneous)

33287	Body feed cable terminal 13/64" eye .....	1	1	1
36111	Body feed cable terminal insulator .....	1	1	1
159085	Body ground cable terminal 5/16" eye .....	1	1	1
176078	Body wiring cable clip .....	x	x	x
194286	Body wiring cable clip .....	2	2	2

### BONNET DASH LINER

206652	Bonnet dash liner .....	2	2	2
187260	Bonnet dash liner hook .....	2	2	2
3866	Washer 3/16" "N" std. ....	2	2	2
7002	Nut No. 8-32 .....	2	2	2

### DOORS

All doors must be adjusted to each respective body. To obtain satisfactory replacement of doors, it is advisable to return the damaged door to be repaired, if possible. If this cannot be done, the customer assumes the responsibility of the new door being a satisfactory fit.

Specify on all orders the upholstery material, color and striping.

195485	Door trimmed assembly front right .....	1	1	1
195483	Door trimmed assembly front left .....	1	1	1
195489	Door trimmed assembly rear right .....	1	1	1
195487	Door trimmed assembly rear left .....	1	1	1

Piece No.	Name	No. Required		
		730	731	741
<b>DOOR PART</b>				
111671	Door bumper .....	8	8	8
185143	Door check-left .....	1	1	1
185142	Door check-right .....	1	1	1
177021	Door check escutcheon plate .....	2	2	2
185235	Door check stop plate assembly left .....	1	1	1
185233	Door check stop plate assembly right .....	1	1	1
180704	Door curtain carrier rod left .....	2	-	-
176125	Door curtain carrier rod left .....	-	2	2
180703	Door curtain carrier rod right .....	2	-	-
176124	Door curtain carrier rod right .....	-	2	2
165759	Door curtain carrier socket .....	4	4	4
119226	Door dove tail bumper .....	8	8	8
119245	Door dove tail bumper clip .....	8	8	8
119297	Door dove tail casing .....	4	4	4
119296	Door dove tail female retainer .....	4	4	4
118500	Door hinge .....	8	8	8
8029	Screw No. 12-24 x 5/16" oval hd. ....	32	32	32
119298	Door dove tail male .....	4	4	4
165021	Door lock .....	4	4	4
176788	Door lock handle .....	4	4	4
165014	Door lock lever assembly right .....	2	2	2
165015	Door lock lever assembly left .....	2	2	2
168020	Door lock lever handle nut .....	4	4	4
174113	Door lock lever handle right .....	2	2	2
174114	Door lock lever handle left .....	2	2	2
174115	Door lock lever and link assembly front right .....	1	1	1
174116	Door lock lever and link assembly front left .....	1	1	1
173814	Door lock striker right .....	2	2	2
174223	Door lock striker left .....	2	2	2
193656	Door scuff plate front left .....	1	1	1
193655	Door scuff plate front right .....	1	1	1
193642	Door scuff plate rear right .....	1	1	1
193643	Door scuff plate rear left .....	1	1	1

### FASTENER

195664	Fastener eyelet-top envelope .....	X	X	X
161792	Fastener eyelet plate-top envelope .....	X	X	X
161794	Fastener screw post-rear seat back rail .....	X	X	X
193200	Snap fastener machine screw post carpet front floor .....	X	X	X
115268	Snap fastener mach. screw post single-top curtain .....	X	X	X
116554	Snap fastener mach. screw post double-top curtain .....	X	X	X
139157	Snap fastener rivet post female-door pocket .....	X	X	X
139160	Snap fastener rivet post male long-door pocket .....	X	X	X
139157	Snap fastener rivet post female-top curtain .....	X	X	X
139158	Snap fastener rivet post male-top curtain .....	X	X	X
148637	Snap fastener rivet post male-top curtain .....	X	X	X
193199	Snap fastener rivet post-female carpet front floor .....	X	X	X
175757	Snap fastener rivet post (eyelet) top envelope .....	X	X	X
193201	Snap fastener screw post-carpet front floor .....	X	X	X
193201	Snap fastener screw post-carpet rear floor .....	X	X	X
159060	Snap fastener screw stud (Self tapping)-carpet front floor .....	X	X	X
159060	Snap fastener screw stud (Self tapping) cowl panel tab.....	X	X	X
137510	Snap fastener socket-cowl panel tab .....	X	X	X
112054	Snap fastener socket top-cowl panel tab .....	X	X	X
112058	Snap fastener screw post-top curtain .....	X	X	X
214974	Snap fastener socket female-door pocket .....	X	X	X

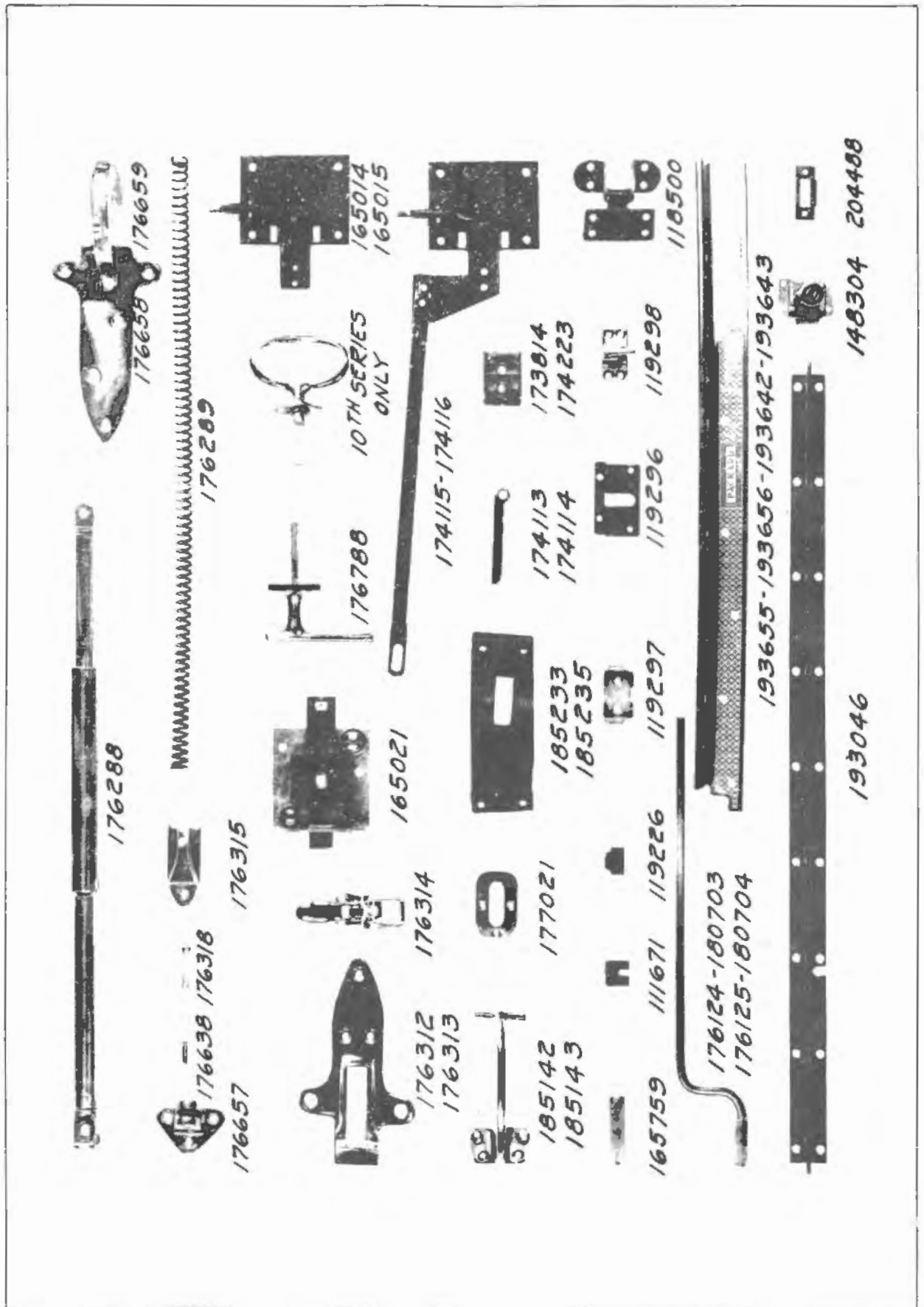



Piece No.	Name	No. Required		
		730	731	741
76926	Snap fastener socket female-top curtain .....	x	x	x
139150	Snap fastener socket female-top curtain .....	x	x	x
115799	Snap fastener socket-carpet front floor .....	x	x	x
115799	Snap fastener socket-carpet rear floor .....	x	x	x
115798	Snap fastener socket ring-carpet front floor .....	x	x	x
115798	Snap fastener socket ring-carpet rear floor .....	x	x	x
139159	Snap fastener socket-door panel .....	x	x	x
76925	Snap fastener socket male-short prong .....	x	x	x
102150	Snap fastener socket male-long prong .....	x	x	x
139159	Snap fastener socket top curtain .....	x	x	x
139150	Snap fastener socket-top envelope .....	x	x	x
139157	Snap fastener stud (eyelet type) top envelope .....	x	x	x
139158	Snap fastener stud (eyelet)-top envelope .....	x	x	x
193200	Snap fastener stud (machine screw)-top curtain .....	x	x	x
116446	Snap fastener wood screw post double-top curtain .....	x	x	x
106755	Snap fastener wood screw post single-top curtain .....	x	x	x

## FLOOR BOARD

206476	Floor board front assembly .....	-	1	1
206477	Floor board front assembly .....	1	-	-
206481	Floor board front felt front .....	1	1	1
206480	Floor board front felt center .....	1	1	1
206479	Floor board front felt rear .....	1	1	1
206482	Floor board front felt side .....	-	2	2
206483	Floor board front felt side .....	2	-	-
196000	Floor board rear assembly .....	1	-	-
8214	Screw 1/4-28 x 3/4" flat hd. ....	2	2	2

## FLOOR CARPET

Specify color and type of binding when ordering carpet

204627	Floor carpet front assembly .....	-	1	1
204628	Floor carpet front assembly .....	1	-	-
204636	Floor carpet rear assembly .....	1	-	-
212224	Floor carpet rear assembly .....	-	1	1

## FOLDING ARM REST

211292	Folding arm rest trimmed assembly .....	1	-	-
211290	Folding arm rest trimmed assembly .....	-	1	1
187134	Folding arm rest cushion .....	-	1	1
211296	Folding arm rest cushion .....	1	-	-
211259	Folding arm rest spring .....	1	-	-
211247	Folding arm rest spring .....	-	1	1
187544	Folding arm rest support bracket assembly .....	1	-	-
211297	Folding arm rest support bracket assembly .....	-	1	1
171580	Screw No. 10-32 x 5/8" flat hd. mach. ....	6	6	6
7824	Screw 1/4-28 x 5/8" hex. hd. ....	4	4	4
5502	Lockwasher 1/4" std. ....	4	4	4
7004	Nut 1/4-28 .....	4	4	4

Piece No.	Name	No. Required		
		730	731	741
<b>FOLDING SEAT</b>				
193961	Folding seat trimmed assembly .....	2	-	-
187498	Folding seat untrimmed assembly .....	2	-	-
169102	Folding seat back untrimmed assembly .....	2	-	-
167945	Folding seat back to seat frame screw .....	4	-	-
172294	Folding seat cushion spring .....	2	-	-
193826	Folding seat floor carpet assembly .....	2	-	-
171692	Folding seat frame assembly .....	2	-	-
5580	Screw No. 10-32 x 1" flat hd. ....	16	-	-
5229	Screw 1/4-28 x 1-3/8" flat hd. ....	8	-	-
8220	Screw 1/4-28 x 1-1/2" flat hd. ....	8	-	-
7003	Nut No. 10-32 .....	16	-	-
7004	Nut 1/4-28 .....	16	-	-
3867	Washer 3/16" special .....	4	-	-
171698	Folding seat frame side left .....	2	-	-
171703	Folding seat frame side right .....	2	-	-
184024	Folding seat handle .....	2	-	-
100100	Folding seat pivot pin .....	4	-	-
187421	Folding seat pivot pin retainer .....	2	-	-
187410	Folding seat support left .....	2	-	-
187411	Folding seat support right .....	2	-	-
130889	Folding seat support to seat frame screw .....	4	-	-
7006	Nut 3/8-24 .....	4	-	-
5508	Lockwasher 3/8" .....	4	-	-

### FOOT REST

163745	Foot rest assembly .....	-	1	1
163743	Foot rest assembly .....	1	-	-
166444	Foot rest bar .....	1	-	-
166445	Foot rest bar end support right assembly .....	1	-	-
166442	Foot rest bar end support right assembly .....	-	1	1
166446	Foot rest bar end support left assembly .....	1	-	-
166443	Foot rest bar end support left assembly .....	-	1	1
147963	Foot rest pivot stud .....	2	-	-

### FRONT SEAT

193603	Front seat-left-back spring .....	1	1	1
193602	Front seat-right-back spring .....	1	1	1
212695	Front seat compartment bottom battery cover assembly .....	1	1	1
212690	Front seat compartment bottom battery cover clamp .....	2	2	2
5687	Screw 1/4-28 x 5/8 fill. hd. ....	2	2	2
212691	Front seat compartment bottom battery cover gasket .....	1	1	1
193861	Front seat-left-cushion assembly .....	1	1	1
193863	Front seat-right-cushion assembly .....	1	1	1
181141	Front seat cushion dowel female .....	4	4	4
181036	Front seat cushion dowel male .....	4	4	4
183259	Front seat-right-cushion spring .....	1	1	1
183280	Front seat-left-cushion spring .....	1	1	1
199722	Front seat-left-locking spring .....	1	1	1
199718	Front seat-left-operating spring .....	1	1	1
180845	Front seat-left-support bar assembly .....	1	1	1



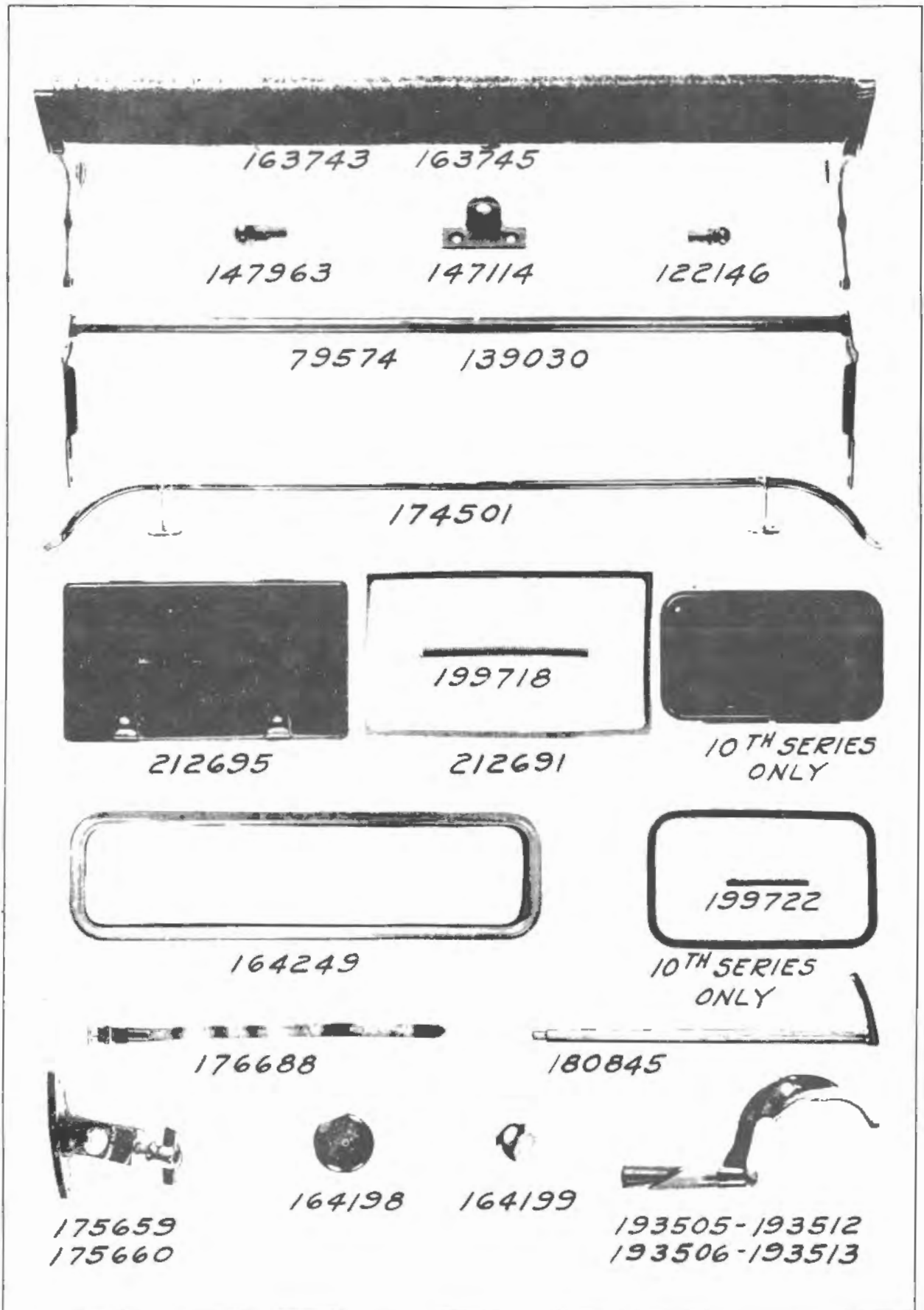



Piece No.	Name	No. Required		
		730	731	741

## HAND BRAKE CUTOUT COVER

204455	Hand brake lever cutout cover .....	1	1	1
--------	-------------------------------------	---	---	---

## PANEL

212981	Panel cowl assembly .....	1	1	1
212993	Panel dash assembly .....	1	1	1
212997	Panel dash cover assembly .....	1	1	1
212878	Panel dash inter liner .....	1	1	1
212978	Panel dash liner .....	1	1	1
193400	Panel-door front right assembly .....	1	1	1
193401	Panel-door front left assembly .....	1	1	1
193402	Panel-door rear right assembly .....	1	1	1
193403	Panel-door rear left assembly .....	1	1	1

## REAR SEAT

211262	Rear seat back spring-right .....	1	-	-
211263	Rear seat back spring-left .....	1	-	-
211245	Rear seat back spring-right .....	-	1	1
211246	Rear seat back spring-left .....	-	1	1
193875	Rear seat cushion assembly .....	1	-	-
204195	Rear seat cushion assembly .....	-	1	1
181141	Rear seat cushion dowel female .....	2	2	2
181036	Rear seat cushion dowel male .....	2	2	2
3877	Washer 3/8" "N" std. ....	2	2	2
187522	Rear seat cushion spring .....	1	-	-
204257	Rear seat cushion spring .....	-	1	1

## REAR VIEW MIRROR

176816	Rear view mirror assembly .....	1	1	1
191368	Rear view mirror glass .....	1	1	1
5589	Screw No. 10-32 x 1/2" rnd. hd. ....	2	2	2

## ROBE RAIL

174501	Robe rail assembly .....	1	1	-
--------	--------------------------	---	---	---

## SPOTLIGHT

206633	Spotlight assembly .....	1	1	1
102507	Spotlight cable grommet .....	1	1	1
206636	Spotlight bracket .....	1	1	1

## TONNEAU COWL

178705	Tonneau cowl trimmed assembly .....	-	-	1
176786	Tonneau cowl bumper .....	-	-	2
176314	Tonneau cowl clamp .....	-	-	2
6284	Screw No. 10-32 x 1-3/8" oval hd. ....	-	-	6
176315	Tonneau cowl clamp bracket and bumper retainer .....	-	-	2
176288	Tonneau cowl counterbalance assembly .....	-	-	2
176638	Tonneau cowl counterbalance screw lower .....	-	-	2

Part No.	Name	No. Required		
		730	731	741
177006	Tonneau cowl counterbalance screw upper .....	-	-	2
176657	Tonneau cowl counterbalance bracket lower .....	-	-	2
176289	Tonneau cowl counterbalance spring .....	-	-	2
176312	Tonneau cowl hinge female right .....	-	-	1
176313	Tonneau cowl hinge female left .....	-	-	1
5595	Screw 3/8-24 x 1-3/4" hex. hd. ....	-	-	4
5506	Lockwasher 3/8" std. ....	-	-	4
176658	Tonneau cowl hinge male right .....	-	-	1
176659	Tonneau cowl hinge male left .....	-	-	1
176318	Tonneau cowl hinge screw .....	-	-	2

### TONNEAU LIGHT

180645	Tonneau light assembly .....	2	2	2
102590	Tonneau light bulb 7 V 3 CP G-6 single contact .....	2	2	2
180646	Tonneau light glass and rim .....	2	2	2
176778	Tonneau light to ground cable assembly .....	2	2	2
180647	Tonneau light reflector .....	2	2	2
199732	Tonneau light switch .....	2	2	2
127502	Tonneau light switch plunger plate .....	2	2	2

### TONNEAU VENTILATOR

176296	Tonneau ventilator cover assembly left .....	-	-	1
176650	Tonneau ventilator cover assembly right .....	-	-	1
176301	Tonneau ventilator cover spring .....	-	-	2
204418	Tonneau ventilator finishing plate left .....	-	-	1
204417	Tonneau ventilator finishing plate right .....	-	-	1
5766	Screw No. 6-40 x 3/8" oval hd. ....	-	-	6
176304	Tonneau ventilator knob .....	-	-	2
5500	Lockwasher 3/16" std. ....	-	-	2
7003	Nut No. 10-32 .....	-	-	2
204419	Tonneau ventilator screen .....	-	-	2

### TOOL COMPARTMENT

200527	Tool compartment door assembly .....	-	1	1
139046	Tool compartment door hinge .....	-	1	1
148304	Tool compartment door lock .....	-	1	1
204488	Tool compartment door lock striker .....	-	1	1

### TOP

193612	Top assembly .....	1	-	-
176100	Top assembly .....	-	1	1
176105	Top bow No. 1 .....	-	1	1
176133	Top bow No. 1 .....	1	-	-
180326	Top bow No. 2 .....	1	-	-
176106	Top bow No. 2 .....	-	1	1
193496	Top bow No. 3 .....	1	-	-
193497	Top bow No. 3 .....	-	1	1
193450	Top bow No. 3 auxiliary bow .....	1	1	1
176104	Top bow front .....	1	1	1
193610	Top bow slat assembly right .....	1	-	-
176102	Top bow slat assembly right .....	-	1	1
193611	Top bow slat assembly left .....	1	-	-

Piece No.	Name	No. Required		
		730	731	741
176103	Top bow slat assembly left .....	-	1	1
193506	Top bow support assembly left .....	-	1	1
193513	Top bow support assembly left .....	1	-	-
193505	Top bow support assembly right .....	-	1	1
193512	Top bow support assembly right .....	1	-	-
176799	Top bow support nut .....	2	2	2
176688	Top bow support strap assembly .....	2	2	2
211963	Top door curtain front left assembly .....	1	-	-
211965	Top door curtain front left assembly .....	-	1	1
211964	Top door curtain front right assembly .....	1	-	-
211966	Top door curtain front right assembly .....	-	1	1
193802	Top door curtain rear right assembly .....	1	-	-
193804	Top door curtain rear right assembly .....	-	1	1
193801	Top door curtain rear left assembly .....	1	-	-
193803	Top door curtain rear left assembly .....	-	1	1
193805	Top envelope assembly .....	1	-	-
193806	Top envelope assembly .....	-	1	1
164249	Top rear curtain window .....	1	1	1
193808	Top rear seat curtain right assembly .....	1	-	-
193810	Top rear seat curtain right assembly .....	-	1	1
193807	Top rear seat curtain left assembly .....	1	-	-
193809	Top rear seat curtain left assembly .....	-	1	1
164198	Top support bracket nut .....	2	2	2
164199	Top support bracket nut-lock .....	2	2	2
175659	Top to windshield clamp bracket assembly right .....	1	1	1
175660	Top to windshield clamp bracket assembly left .....	1	1	1
5752	Screw 1/4-28 x 1-5/32" oval hd. ....	4	4	4
3868	Washer 1/4" "N" std. ....	4	4	4
7004	Nut 1/4-28 .....	4	4	4

## VENTILATOR

193814	Ventilator cover assembly .....	1	1	1
137537	Ventilator cover hinge screw .....	2	2	2
3868	Washer 1/4" "N" std. ....	2	2	2
7104	Nut 1/4-28 castle .....	2	2	2
4280	Pin 1/16 x 1/2" cotter .....	2	2	2
185776	Ventilator cover operating lever .....	1	1	1
7800	Screw 1/4-28 x 1" hex. hd. ....	2	2	2
5502	Lockwasher 1/4" std. ....	2	2	2
7004	Nut 1/4-28 .....	2	2	2
3868	Washer 1/4" "N" std. ....	2	2	2
118555	Ventilator cover operating lever pin .....	1	1	1
118771	Ventilator cover operating pin roller .....	1	1	1
4280	Pin 1/16 x 1/2" cotter .....	1	1	1
195684	Ventilator cover operating lever ratchet .....	1	1	1
5792	Ventilator cover operating lever ratchet yoke end pin 5/16" .....	1	1	1
4290	Pin 3/32 x 5/8" cotter .....	1	1	1
138261	Ventilator cover spring .....	1	1	1
145383	Ventilator hinge adjusting plate assembly left .....	1	1	1
145384	Ventilator hinge adjusting plate assembly right .....	1	1	1
187137	Ventilator screen assembly .....	1	1	1
8011	Screw No. 8-32 x 7/16" oval hd. ....	6	6	6
3774	Lockwasher No. 8 std. ....	6	6	6
7002	Nut No. 8-32 .....	6	6	6
185800	Ventilator side door gutter and operating lever bracket assembly right .....	1	1	1
185799	Ventilator side door gutter and operating lever bracket assembly left. ....	1	1	1
185798	Ventilator side door and hinge assembly right .....	1	1	1
185797	Ventilator side door and hinge assembly left .....	1	1	1

Piece No.	Name	No. Required		
		750	731	741
185893	Ventilator side door hinge bumper .....	2	2	2
185809	Ventilator side door hinge pin .....	2	2	2
4690	Pin spring cotter 1/16 x 3/8" .....	2	2	2
199170	Ventilator side door operating lever handle .....	2	2	2
5954	Screw No. 10-32 x 5/16" oval hd. ....	4	4	4
199360	Ventilator side door operating lever plunger .....	2	2	2
5346	Screw No. 10-32 x 7/8" rnd. hd. ....	2	2	2
5500	Lockwasher No. 10 .....	2	2	2
7003	Nut No. 10-32 .....	2	2	2
199192	Ventilator side door operating lever sleeve .....	2	2	2
5667	Screw No. 10-32 x 5/8" rnd. hd. ....	2	2	2
5500	Lockwasher No. 10 .....	2	2	2
7003	Nut No. 10-32 .....	2	2	2
185808	Ventilator side door operating spring .....	2	2	2
185814	Ventilator side weatherstrip .....	2	2	2
185938	Ventilator weatherstrip .....	1	1	1
185937	Ventilator weatherstrip .....	1	1	1

## WINDSHIELD

204992	Windshield assembly .....	1	-	-
204993	Windshield assembly .....	-	1	1
204960	Windshield assembly tonneau .....	-	-	1
5753	Windshield to body screw 5/16-24 x 1-7/8" hex. hd. ....	6	6	6
7846	Windshield to body screw 3/8-24 x 2-5/8" hex. hd. ....	2	2	2
7869	Windshield to body screw 3/8-24 x 1-7/8" hex. hd. ....	2	2	2
7822	Windshield to body screw 3/8-24 x 1-1/2" hex. hd. ....	2	2	2
197055	Washer 3/8" .....	6	6	6
5506	Lockwasher 3/8" .....	6	6	6
3909	Washer 5/16" special .....	6	6	6
5504	Lockwasher 5/16" std. ....	6	6	6
193379	Windshield cleaner dash connection .....	1	1	1
173133	Screw No. 10 x 1/2" flat hd. ....	2	2	2
204884	Windshield cleaner to dash connection tube assembly right .....	1	1	1
204883	Windshield cleaner to dash connection tube assembly left .....	1	1	1
183463	Windshield cleaner to dash connection tube union nut 3/16" .....	2	2	2
157688	Windshield cleaner to dash connection tube adapter 3/16" .....	2	2	2
143360	Windshield cleaner to dash connection tube clip single .....	1	1	1
199787	Screw No. 8 x 1/2" (Parker-Kalon) binding head (Pilot point) .....	1	1	1
211295	Windshield cleaner dash connection vacuum supply tube assembly .....	1	1	1
157477	Windshield cleaner dash connection vacuum supply tube union nut .....	2	2	2
177851	Windshield cleaner dash connection vacuum supply tube (flared tube connection) adapter .....	2	2	2
140007	Windshield cleaner hose .....	2	2	2
206558	Windshield cleaner motor complete right .....	1	1	1
206559	Windshield cleaner motor complete left .....	1	1	1
206834	Windshield cleaner motor attaching nut .....	2	2	2
206040	Windshield cleaner motor attaching washer .....	2	2	2
206189	Windshield cleaner motor operating lever knob .....	2	2	2
210070	Windshield cleaner vacuum pump dash connection .....	1	1	1
7007	Nut 7/16-20 hex. ....	1	1	1
5806	Lockwasher 7/16" Shakeproof .....	1	1	1
3883	Washer 7/16" plain .....	1	1	1
209512	Windshield cleaner vacuum pump to dash connection tube assembly .....	1	1	1
6261	Nut 1/4" flared tube inverted .....	1	1	1
6273	Elbow 1/4" flared tube inverted .....	1	1	1
209578	Clip style No. 14 .....	1	1	1
167261	Screw No. 10 (.187) x 3/8" (Parker-Kalon) .....	1	1	1
209463	Windshield cleaner vacuum pump to manifold tube assembly .....	1	1	1

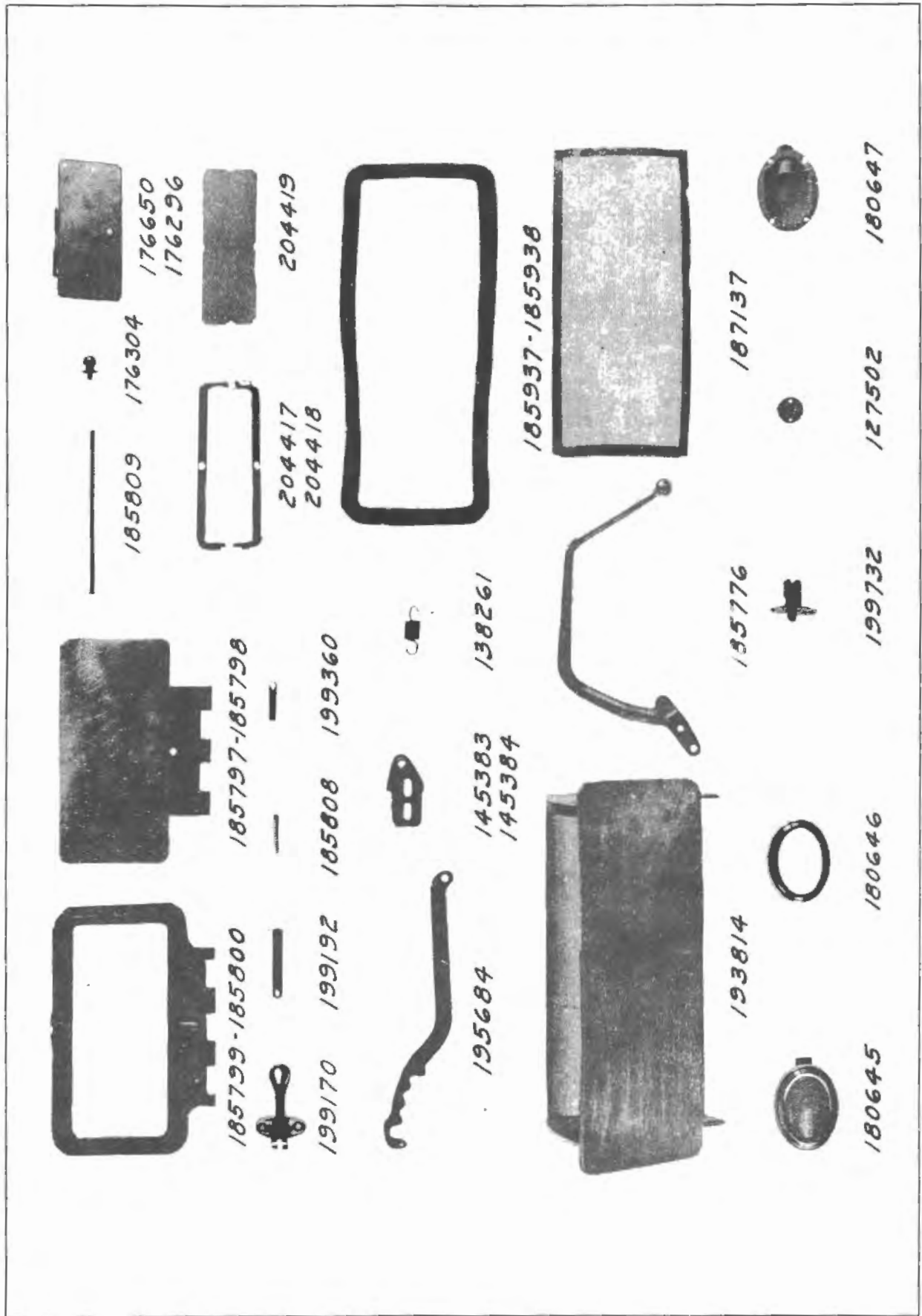



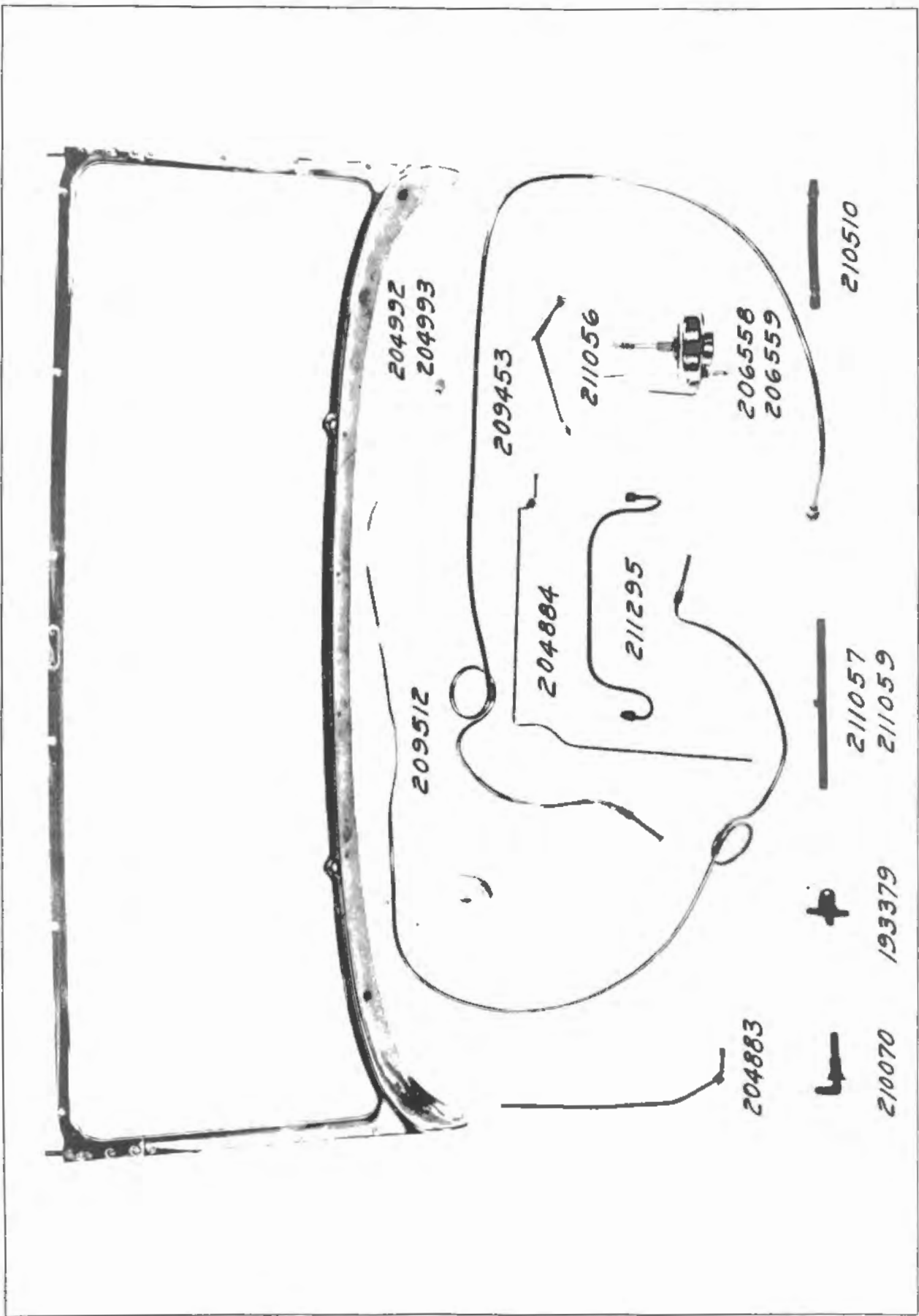

Piece No.	Name	No. Required		
		730	731	741
6262	Nut 5/16" flared tube inverted .....	1	1	1
6273	Elbow 5/16" flared tube inverted .....	1	1	1
6271	Tee 5/16" flared tube inverted .....	1	1	1
5867	Union nut 5/16" flared tube .....	1	1	1
209579	Windshield cleaner vacuum pump tube clip .....	2	2	2
211059	Windshield cleaner wiper .....	2	-	-
211057	Windshield cleaner wiper .....	-	2	2
211056	Windshield cleaner wiper arm .....	2	2	2
115268	Windshield curtain fastener .....	6	6	6
117569	Windshield curtain fastener .....	10	10	10
5780	Windshield side screw long .....	4	4	4
6303	Windshield side screw short .....	4	4	4
206568	Windshield to cowl liner .....	1	1	1
193465	Windshield glass-tonneau .....	-	-	1
206020	Windshield glass .....	1	-	-
206051	Windshield glass .....	-	1	1

## TRIMMING

To avoid errors due to difference in texture and shade, please furnish sample when ordering trimming material.

212677	Assembly-cowl trim panel-left (Specify set number) .....	1	1	1
212676	Assembly-cowl trim panel-right (Specify set number) .....	1	1	1
192689	Assembly-door trimming-front left (Specify set number) .....	1	1	1
192691	Assembly-door trimming-front right (Specify set number) .....	1	1	1
192693	Assembly-door trimming-rear left (Specify set number) .....	1	1	1
192695	Assembly-door trimming-rear right (Specify set number) .....	1	1	1
156596	Binding lace 7/16" (Specify set number) .....	x	x	x
176578	Binding leather wire on colonial grain (Specify set number) .....	x	x	x
176579	Binding leather wire on (cordless) (Specify set number) .....	x	x	x
192088	Binding imitation leather wire on colonial grain (undyed backing) ....	x	x	x
29618	Buckram 2 ply 36" wide .....	x	x	x
166480	Button mould No. 22 ligne upholsters shell .....	42	36	36
166479	Button mould No. 22 ligne upholsters filler .....	42	36	36
166478	Button mould No. 22 ligne upholsters eye .....	42	36	36
184555	Button leather covered upholsters tufting (Specify set number) .....	42	36	36
200996	Carpet rubber set 36" wide (Specify set number) .....	-	x	x
200995	Carpet rubber set 36" wide (Specify set number) .....	x	x	x
33883	Celluloid side curtain lights 20 x 36" .....	x	x	x
29651	Cloth cotton 36" wide .....	x	x	x
179401	Cord welt enameled drill .....	x	x	x
195209	Cord welt enameled drill .....	x	x	x
159187	Cord welt 3/4 x 1/4 colonial leather (Specify set number) .....	x	x	x
161787	Drill white cotton 7 oz. 36" wide .....	x	x	x
105025	Drill enameled 50" wide long grain .....	x	x	x
200525	Duck black double filled 1.35050" .....	x	x	x
200467	Fabric top material 54" wide .....	x	x	x
174513	Fabric 54" filled mole skin .....	x	x	x
156692	Gimp 1/2" imitation black colonial leather .....	x	x	x
175234	Gimp 3/4" leather colonial grain .....	x	x	x
170310	Gimp 1/2" leather colonial grain .....	x	x	x
214054	Hair interlaced 52" wide .....	x	x	x
172326	Hair and wadding batts 4" - 6 oz. ....	-	x	-
172327	Hair and wadding batts 5-1/4" - 10 oz. ....	-	x	-
163380	Hair pad 36" wide 1/4" all cow hair burlap center .....	x	x	x
127473	Hair Wilson and Co. super bovine grey or its equivalent .....	x	x	x
156346	Leather imitation colonial grain (Specify set number) .....	x	x	x
156348	Leather trimming colonial grain (Specify set number) .....	x	x	x

Piece No.	Name	No. Required		
		730	731	741
192303	Muslin rubber 54" wide .....	X	X	X
140935	Paper board 1/2 x 48" .....	X	X	X
184236	Rubber riser 3/16" half round .....	X	X	X
115023	Rubber riser 3/8" half oval .....	X	X	X
140900	Rubber riser 1/4" half round .....	X	X	X
108123	Rubber tubing 5/16" O.D. x 3/64" wall .....	X	X	X
134163	Rubber tubing 3/8" O.D. x 1/16" wall .....	X	X	X
29652	Tacks-japanned lace 2 oz. ....	X	X	X
106964	Tacks-gimp 3 oz. japanned .....	X	X	X
113812	Tacks-gimp 4 oz. japanned .....	X	X	X
29657	Tacks-japanned lace 4 oz. ....	X	X	X
211930	Tacks trimmers 2-1/2 oz. galvanized .....	X	X	X
211931	Tacks trimmers 4 oz. galvanized .....	X	X	X
211932	Tacks trimmers 10 oz. galvanized .....	X	X	X
29663	Tacks trimmers 2-1/2 oz. japanned .....	X	X	X
29664	Tacks trimmers 4 oz. japanned .....	X	X	X
29666	Tacks trimmers 10 oz. japanned .....	X	X	X
113789	Tacks gimp 6 oz. japanned .....	X	X	X
29640	Thread "EE" No. 12 or Dean and Sheck No. 12-4 .....	X	X	X
127808	Thread Dean and Sheck No. 20-A silk finish .....	X	X	X
157586	Thread No. 1201 cord .....	X	X	X
29625	Twine No. 252 Yazoo .....	-	X	X
192208	Wadding 3" white cotton rolled 3-1/2 oz. ....	X	X	X
29627	Wadding 33" blue sheet No. 532 .....	X	X	X
182687	Wadding 32" white unbleached No. 532 .....	X	X	X
192209	Wadding 5" white cotton rolled 6 oz. ....	X	X	X
128040	Wadding 33" white sheet .....	X	X	X
62759	Webbing 3" wide jute .....	X	X	X
172470	Wadding 4" white cotton unbleached rolled 5 oz. ....	X	X	X
148742	Windlace leather colonial grain (Specify set number) .....	X	X	X

Piece No	Name	No. Required		
		830 930	831 931	821 921
<b>BODY ATTACHING PARTS</b>				
7886	Body to frame bolt No. 1 screw 7/16-20 x 1-3/4 hex. hd. ....	2	2	2
5282	Body to frame bolt No. 2 screw 7/16-20 x 3-1/2 hex. hd. ....	2	2	2
228250	Body to frame bolt No. 2 (inside) screw 7/16-20 x 2-3/8 flat hd. .	2	2	2
5282	Body to frame bolt No. 3 screw 7/16-20 x 3-1/2 hex. hd. ....	2	2	2
7834	Body to frame bolt No. 4 screw 7/16-20 x 3-1/2 hex. hd. ....	4	4	4
7834	Body to frame bolt No. 5 screw 7/16-20 x 3-1/8 hex. hd. ....	4	4	4
5671	Body to frame bolt No. 6 screw 7/16-20 x 5-3/8 hex. hd. ....	2	2	2
7890	Body to frame bolt No. 7 screw 7/16-20 x 1-1/2 hex. hd. ....	2	2	2
5380	Body to frame bolt No. 8 screw 7/16-20 x 4-5/8 hex. hd. ....	2	2	2
131046	Body to frame bolt washer-small washer 7/16 special .....	30	30	30
5508	Body to frame bolt lockwasher 7/16 .....	14	14	14
5806	Body to frame bolt lockwasher 7/16 Shakeproof .....	6	6	6
7007	Body to frame bolt-nut 7/16-20 .....	12	12	12
182439	Body to frame bolt-nut lock .....	8	8	8
185273	Body to frame liner 3/16 thick .....	x	x	x
185270	Body to frame liner 3/8 thick .....	x	x	x
185274	Body to frame liner 1/4 thick .....	x	x	x
226790	Body to frame liner .....	2	2	2
185274	Body hold down bolt bracket liner 1/4 thick .....	x	x	x
185273	Body hold down bolt bracket liner 3/16 thick .....	x	x	x

**ARM REST**

227808	Arm rest vanity case cover plate .....	1	1	1
224262	Arm rest vanity case memo book .....	1	1	1
180082	Arm rest vanity case memo book pencil .....	1	1	1
224263	Arm rest vanity case mirror .....	1	1	1
224647	Arm rest smoking case ash receiver right .....	1	1	1
227757	Arm rest smoking case ash receiver left .....	1	1	1
211191	Arm rest smoking case cigar lighter .....	1	1	1
227810	Arm rest smoking case cover plate .....	1	1	1

**DASH PANEL**

220687	Dash panel body to frame bolt bracket right .....	1	1	1
220688	Dash panel body to frame bolt bracket left .....	1	1	1
224123	Dash panel bonnet dash liner side .....	2	2	2
224124	Dash panel bonnet dash liner top .....	2	2	2
228260	Dash panel bonnet dash liner hook .....	4	4	4
229340	Washer 3/16 .....	4	4	4
7002	Nut No. 8-32 .....	4	4	4
228251	Dash panel bonnet dash liner hook saddle .....	4	4	4
187803	Dash panel bonnet dash liner staple .....	6	6	6
228246	Dash panel bonnet dash liner staple saddle .....	6	6	6
220941	Dash panel interliner .....	1	1	1
220942	Dash panel liner .....	1	1	1
111074	Dash panel liner snap fastener stud (Eyelet type) .....	8	8	8
123094	Dash panel liner snap fastener stud eyelet .....	8	8	8
5317	Dash panel liner screw 1/4-28 x 1-1/8 hex. hd. ....	2	2	2
5502	Lockwasher 1/4 .....	2	2	2
62065	Washer 1/4 plain .....	1	1	1

**DOOR PARTS**

227898	Door anti-rattler .....	2	2	2
227890	Door bumper upper-long .....	x	x	x

Piece No.	Name	No. Required		
		830 930	831 931	821 921
227891	Door bumper upper-medium .....	x	x	x
227889	Door bumper upper-short .....	x	x	x
227886	Door bumper rear-lower .....	x	x	x
185601	Door bumper front-lower .....	x	x	x
227898	Door bumper retainer upper .....	4	4	4
227893	Door check strap fastener plate front .....	2	2	2
227894	Door check strap .....	4	4	4
227897	Door check strap guide assembly .....	2	2	2
224171	Door dove-tail female front .....	2	2	2
224170	Door dove-tail female rear .....	2	2	2
224169	Door dove-tail male front .....	4	4	4
224163	Door dove-tail male rear .....	2	2	2
227592	Door front curtain carrier rod-front right .....	1	1	1
227593	Door front curtain carrier rod-front left .....	1	1	1
227594	Door front curtain carrier rod-rear right .....	1	1	1
227595	Door front curtain carrier rod-rear left .....	1	1	1
227624	Door hinge assembly upper .....	2	2	2
227630	Door hinge assembly lower .....	2	2	2
227603	Door hinge pin .....	4	4	4
227601	Door hinge pin screw .....	4	4	4
227926	Door hinge pin screw washer .....	32	32	32
229344	Door lock front right .....	1	1	1
229345	Door lock front left .....	1	1	1
183171	Door lock rear left .....	1	1	1
183170	Door lock rear right .....	1	1	1
227726	Door lock handle front right .....	1	1	1
227727	Door lock handle front left .....	1	1	1
227710	Door lock handle rear right .....	1	1	1
227711	Door lock handle rear left .....	1	1	1
206187	Door lock handle escutcheon plate .....	4	4	4
226515	Door lock remote control handle .....	4	4	4
224539	Door lock remote control handle escutcheon plate .....	4	4	4
193078	Door lock remote control handle escutcheon plate spring .....	4	4	4
220980	Door lock striker .....	4	4	4
211539	Door pull to handle .....	1	1	1
227594	Door rear curtain carrier rod-front left .....	-	1	1
227595	Door rear curtain carrier rod-front right .....	-	1	1
227594	Door rear curtain carrier rod-rear right .....	1	1	1
227595	Door rear curtain carrier rod-rear left .....	1	1	1
227266	Door rear curtain carrier rod-rear right .....	1	-	-
227267	Door rear curtain carrier rod-rear left .....	1	-	-
227738	Door scuff plate rear upper right .....	1	-	-
227736	Door scuff plate rear upper right .....	-	1	1
227739	Door scuff plate rear upper left .....	1	-	-
227737	Door scuff plate rear upper left .....	-	1	1
224237	Door scuff plate rear lower .....	-	2	2
224307	Door scuff plate rear lower right .....	1	-	-
224308	Door scuff plate rear lower left .....	1	-	-
227728	Door scuff plate front upper right .....	1	1	1
227729	Door scuff plate front upper left .....	1	1	1
224317	Door scuff plate front lower right .....	1	1	1
224318	Door scuff plate front lower left .....	1	1	1
227839	Door striker rear door bottom .....	2	2	2

## FLOOR BOARD

220769	Floor board front assembly .....	1	1	1
220771	Floor board front felt front .....	1	1	1
220773	Floor board front felt rear .....	1	1	1
220772	Floor board front felt side .....	2	2	2

Piece No.	Name	No. Required		
		830 930	831 931	821 921
<b>FLOOR MAT</b>				
227996	Floor mat front .....	1	1	1
227998	Floor mat rear .....	-	1	1
227563	Floor mat rear .....	1	-	-

### FOLDING SEAT

224065	Folding seat untrimmed assembly .....	2	-	-
224154	Folding seat back untrimmed assembly .....	2	-	-
185113	Folding seat back to seat frame screw .....	2	-	-
172294	Folding seat cushion spring .....	2	-	-
220932	Folding seat floor plate assembly .....	1	-	-
224064	Folding seat frame assembly .....	2	-	-
5580	Screw No. 10-32 x 1 flat hd. ....	16	-	-
5229	Screw 1/4-28 x 1-3/8 flat hd. ....	8	-	-
8220	Screw 1/4-28 x 1-1/2 flat hd. ....	8	-	-
7003	Nut No. 10-32 .....	16	-	-
7004	Nut 1/4-28 .....	16	-	-
3867	Washer 3/16 special .....	4	-	-
185118	Folding seat frame side right .....	2	-	-
185111	Folding seat frame side left .....	2	-	-
228150	Folding seat handle assembly .....	2	-	-
100100	Folding seat pivot pin .....	2	-	-
206920	Folding seat support right .....	2	-	-
206919	Folding seat support left .....	1	-	-
185114	Folding seat support to seat frame screw .....	4	-	-
7006	Nut 3/8-24 .....	4	-	-
5506	Lockwasher 3/8 .....	4	-	-

### FOOT REST

212654	Foot rest bar assembly .....	1	1	1
224548	Foot rest support right .....	1	1	1
224549	Foot rest support left .....	1	1	1
224573	Foot rest support bracket .....	2	2	2
8013	Screw No. 10-32 x 1-1/8 oval hd. ....	4	4	4
224537	Foot rest to support bracket screw .....	2	2	2
206130	Foot rest support bracket cushion .....	2	2	2

### FRONT SEAT

227274	Front seat back spring right .....	1	-	-
227940	Front seat back spring right .....	-	1	1
227941	Front seat back spring left .....	1	1	1
227938	Front seat cushion spring right .....	1	1	1
227939	Front seat cushion spring left .....	1	1	1
227631	Front seat (left) operating button and cable assembly .....	1	1	1
226527	Front seat (left) operating button spring .....	1	1	1
220797	Front seat (left) operating button finishing plate .....	1	1	1
224302	Front seat (left) operating cable guide assembly .....	1	1	1
212848	Front seat (left) support operating mechanism right .....	1	1	1
212849	Front seat (left) support operating mechanism left .....	1	1	1

Piece No.	Name	No. Required		
		830	831	821

930	931	921
-----	-----	-----

### MOULDING

224452	Moulding door trim panel .....	4	4	4
--------	--------------------------------	---	---	---

### REAR SEAT

227946	Rear seat back spring right .....	1	1	1
227947	Rear seat back spring left .....	1	1	1
227943	Rear seat cushion spring .....	1	1	1
212602	Rear seat folding arm rest cushion .....	1	1	1
227948	Rear seat folding arm seat spring .....	1	1	1

### REAR VIEW MIRROR

229268	Rear view mirror complete .....	1	1	1
5497	Screw No. 10-32 x 1/2 oval hd. ....	2	2	2

### ROBE RAIL

227919	Robe rail assembly .....	1	1	-
--------	--------------------------	---	---	---

### SPOTLIGHT

226532	Spotlight assembly .....	1	1	1
102507	Spotlight cable grommet .....	1	1	1
226784	Spotlight bracket .....	1	1	1

### TONNEAU COWL

227902	Tonneau cowl clamp assembly .....	-	-	2
227901	Tonneau cowl clamp and bracket assembly .....	-	-	2
227904	Tonneau cowl clamp bumper .....	-	-	2
227903	Tonneau cowl clamp and bumper retainer bracket .....	-	-	2
176288	Tonneau cowl counterbalance assembly .....	-	-	2
176638	Tonneau cowl counterbalance screw lower .....	-	-	2
177006	Tonneau cowl counterbalance screw upper .....	-	-	2
176657	Tonneau cowl counterbalance bracket lower .....	-	-	2
176289	Tonneau cowl counterbalance spring .....	-	-	2
227883	Tonneau cowl hinge (on lid) .....	-	-	2
227884	Tonneau cowl hinge right (on body) .....	-	-	1
227885	Tonneau cowl hinge left (on body) .....	-	-	1
227905	Tonneau cowl hinge screw .....	-	-	2

### TONNEAU LIGHT

224559	Tonneau light .....	2	2	2
102590	Tonneau light bulb .....	2	2	2
224597	Tonneau light glass and rim .....	2	2	2
183836	Tonneau light reflector .....	2	2	2



Piece No.	Name	No. Required		
		830 930	851 931	821 921
<b>TOP</b>				
227571	Top assembly complete - less trim .....	1	-	-
227774	Top assembly complete - less trim .....	-	1	1
230519	Top door curtain front left assembly .....	1	1	1
230518	Top door curtain front right assembly .....	1	1	1
230522	Top door curtain rear right assembly .....	1	-	-
230520	Top door curtain rear right assembly .....	-	1	1
230530	Top door curtain rear left assembly .....	1	-	-
230521	Top door curtain rear left assembly .....	-	1	1
227579	Top rear curtain window glass .....	1	1	1
230526	Top rear seat curtain right assembly .....	1	-	-
230524	Top rear seat curtain right assembly .....	-	1	1
230527	Top rear seat curtain left assembly .....	1	-	-
230525	Top rear seat curtain left assembly .....	-	1	1
227776	Top support to body bracket right .....	1	1	1
227777	Top support to body bracket left .....	1	1	1

### VENTILATOR

220711	Ventilator cover assembly .....	1	1	1
5569	Screw No. 10-32 x 1/2 fill. hd. ....	4	4	4
3866	Washer 3/16 .....	4	4	4
5500	Lockwasher 3/16 .....	4	4	4
7003	Nut No. 10-32 .....	4	4	4
220718	Ventilator cover operating lever and roller assembly .....	1	1	1
145661	Screw No. 10-32 .....	1	1	1
5739	Screw No. 10-32 x 1/2 hex. hd. ....	1	1	1
5500	Lockwasher 3/16 .....	2	2	2
220723	Ventilator cover operating lever ratchet assembly .....	1	1	1
5569	Screw No. 10-32 x 1/2 fill. hd. ....	2	2	2
5500	Lockwasher 3/16 .....	2	2	2
7003	Nut No. 10-32 .....	2	2	2
220719	Ventilator cover operating lever ratchet bracket .....	2	2	2
220735	Yoke end pin 5/16 .....	1	1	1
4280	Cotter pin 1/16 x 1/2 .....	1	1	1
199374	Ventilator cover spring .....	1	1	1
220717	Ventilator drain gutter assembly .....	1	1	1
102507	Ventilator drain tube grommet .....	1	1	1
220734	Ventilator drain tube hose .....	2	2	2
5253	Screw No. 10-32 x 3/4 rnd. hd. ....	2	2	2
5500	Lockwasher No. 10 .....	2	2	2
7003	Nut No. 10-32 .....	2	2	2
220726	Ventilator weatherstrip .....	1	1	1

### WHEEL COMPARTMENT

224183	Wheel compartment door brace assembly .....	1	1	1
220780	Wheel compartment door hinge assembly .....	2	2	2
5827	Screw 1/4-28 x 1 flat hd. ....	6	6	6
8220	Screw 1/4-28 x 1-1/2 flat hd. ....	4	4	4
176282	Wheel compartment door lock .....	1	1	1
220960	Wheel compartment door lock handle (with key lock) .....	1	1	1
220961	Wheel compartment door lock handle attaching plate (locking handle) .....	1	1	1
220962	Wheel compartment door lock handle escutcheon plate .....	1	1	1
220963	Screw .....	1	1	1
185236	Washer .....	1	1	1
220784	Wheel compartment door lock striker .....	1	1	1

Piece No.	Name	No. Required		
		830 930	831 931	821 921
228125	Wheel compartment door lock striker shim .....	x	x	x
62065	Washer .....	x	x	x
229328	Wheel compartment door weatherstrip .....	1	1	1

## WINDSHIELD

227766	Windshield assembly .....	1	1	1
227881	Windshield assembly - tonneau .....	-	-	1
227770	Windshield cleaner motor assembly right .....	1	1	1
227771	Windshield cleaner motor assembly left .....	1	1	1
227767	Windshield cleaner control cable assembly .....	2	2	2
227764	Windshield cleaner connection tee .....	1	1	1
227760	Windshield cleaner tube right assembly .....	1	1	1
227761	Windshield cleaner tube left assembly .....	1	1	1
227457	Windshield cleaner tube intermediate assembly .....	1	1	1
210070	Windshield cleaner vacuum pump dash connection .....	1	1	1
7007	Nut 7/16-20 .....	1	1	1
5806	Lockwasher 7/16 Shakeproof .....	1	1	1
3883	Washer 7/16 .....	1	1	1
225629	Windshield cleaner vacuum pump to dash connection tube assembly ...	1	1	1
6399	Union nut 1/4 flared tube .....	1	1	1
6344	Nut 1/4 flared tube inverted weatherhead .....	1	1	1
7824	Windshield cleaner vacuum pump to dash connection tube assembly screw 1/4-28 x 5/8 hex. hd. ....	2	2	2
5451	Screw 5/16-24 x 1-1/2 hex. hd. ....	1	1	1
5502	Lockwasher 1/4 .....	2	2	2
7004	Nut 1/4-28 plain .....	2	2	2
3909	Washer 5/16 special .....	1	1	1
5504	Lockwasher 5/16 .....	1	1	1
7005	Nut .....	1	1	1
163067	Windshield cleaner vacuum pump to dash connection tube assembly clip .....	3	3	3
143130	Clip .....	1	1	1
201721	Screw No. 14 x 3/4 rnd. hd. ....	1	1	1
6279	Windshield cleaner vacuum pump to dash connection tube elbow .....	1	1	1
228940	Windshield cleaner vacuum pump to dash connection tube hose assembly	1	1	1
227722	Windshield cleaner wiper blade .....	2	2	2
227910	Windshield cleaner wiper arm right .....	1	1	1
227911	Windshield cleaner wiper arm left .....	1	1	1
227782	Windshield cleaner wiper arm nut .....	2	2	2
227882	Windshield glass - tonneau .....	-	-	1
227920	Windshield glass .....	1	1	1
227723	Windshield stanchion screw washer .....	2	2	2

Piece No.	Name	No. Required								
		573	574	575	576	577	578	579	583	587
<b>BODY ATTACHING PARTS</b>										
187627	Body to frame bolt No. 1 carriage bolt 7/16-20 x 2-11/16" skew head .....	2	2	2	2	2	2	2	2	2
5282	Body to frame bolt No. 2 screw 7/16-20 x 3-1/2" hex. hd. mach. ....	2	2	2	2	2	2	2	2	2
7954	Body to frame bolt No. 3 screw 7/16-20 x 3-1/4" flat hd. mach. ....	-	-	-	-	2	-	-	-	-
5282	Body to frame bolt No. 3 screw 7/16-20 x 3-1/2" hex. hd. mach. ....	-	-	-	-	-	-	-	-	2
5281	Body to frame bolt No. 3 screw 7/16-20 x 3-7/8" hex. hd. mach. ....	2	2	2	2	-	2	2	2	-
5968	Body to frame bolt No. 4 screw 7/16-20 x 4" flat hd. mach. ....	2	2	2	-	-	-	-	2	-
7954	Body to frame bolt No. 4 screw 7/16-20 x 3-1/4" hex. hd. mach. ....	-	-	-	-	-	2	2	-	-
5281	Body to frame bolt No. 4 screw 7/16-20 x 3-7/8" hex. hd. mach. ....	-	-	-	2	2	-	-	-	-
5282	Body to frame bolt No. 4 screw 7/16-20 x 3-1/2" hex. hd. mach. ....	-	-	-	-	-	-	-	-	2
5671	Body to frame bolt No. 5 screw 7/16-20 x 5-3/8" hex. hd. mach. ....	2	2	2	-	2	2	2	2	-
195694	Body to frame bolt No. 5 screw 7/16-20 x 7-11/16" hex. hd. mach. ....	-	-	-	-	-	-	-	-	2
187285	Body to frame bolt No. 5 carriage bolt 7/16-20 x 7-3/16" skew head .....	-	-	-	2	-	-	-	-	2
182439	Body to frame bolt nut lock .....	4	4	4	2	2	2	2	4	4
131809	Body to frame bolt washer-large washer 7/16" plain special .....	2	2	2	4	4	4	4	2	6
131046	Body to frame bolt washer-small washer 7/16" plain special .....	12	12	12	10	12	12	12	12	10
5508	Body to frame bolt lockwasher 7/16" .....	8	8	8	8	8	8	8	8	6
5806	Body to frame bolt lockwasher (Shakeproof) ...	2	2	2	2	2	2	2	2	4
7007	Body to frame bolt nut 7/16"-20 plain std. ...	8	8	8	8	8	8	8	8	10
193883	Body to frame liner 3/16" thick .....	x	x	x	x	x	x	x	x	x
185271	Body to frame liner 1/4" thick .....	x	x	x	x	x	x	x	x	x
185272	Body to frame liner 5/16" thick .....	x	x	x	x	x	x	x	x	x
193930	Body to frame liner 3/16" thick .....	-	x	x	-	-	-	-	-	-
193931	Body to frame liner 3/16" thick .....	x	-	-	x	x	x	x	x	x
187924	Body to frame liner hand brake lever insulator	1	1	1	1	1	1	1	1	1
185270	Body hold down bolt bracket liner 3/8" thick .	x	x	x	x	x	x	x	x	x
185274	Body hold down bolt bracket liner 1/2" thick .	x	x	x	x	x	x	x	x	x
185273	Body hold down bolt bracket liner 3/16" thick.	x	x	x	x	x	x	x	x	x
133104	Body hold down bolt bracket liner 1/32" thick.	x	x	x	x	x	x	x	x	x
<b>ARM REST AND ARM SLING</b>										
195490	Folding arm rest trimmed assembly .....	1	1	1	1	-	-	-	-	-
195491	Folding arm rest trimmed assembly .....	-	-	-	-	1	-	-	-	-
187544	Folding arm rest support bracket assembly ....	-	-	-	1	-	-	-	-	-
185826	Folding arm rest support bracket assembly ....	-	1	1	-	-	-	-	-	-
187221	Folding arm rest support bracket assembly ....	1	-	-	-	-	-	-	1	-
193133	Folding arm rest support bracket assembly ....	-	-	-	-	1	-	-	-	1
171580	Screw No. 10-32 x 5/8" flat hd. mach. ....	6	6	6	6	6	-	-	6	6
7824	Screw 1/4-28 x 5/8" hex. hd. ....	4	4	4	4	4	-	-	4	4
5502	Lockwasher 1/4" .....	4	4	4	4	4	-	-	4	4
7004	Nut 1/4"-28 .....	4	4	4	4	4	-	-	4	4
187596	Arm rest vanity case mirror .....	1	-	-	-	-	-	-	-	-
172205	Arm rest vanity case mirror .....	-	1	1	-	1	-	-	-	-

Piece No	Name	No. Required								
		573	574	575	576	577	578	579	583	587
187594	Arm rest vanity case memorandum book .....	1	-	-	-	-	-	-	-	-
172204	Arm rest vanity case memorandum book .....	-	1	1	-	1	-	-	-	-
140942	Arm rest vanity case memorandum book pencil ..	-	1	1	-	1	-	-	-	-
180082	Arm rest vanity case memorandum book pencil ..	1	-	-	-	-	-	-	-	-
187826	Arm sling .....	-	2	2	-	-	-	-	-	-
171899	Arm sling rod-left .....	-	1	1	-	-	-	-	-	-
173490	Arm sling rod-right .....	-	1	1	-	-	-	-	-	-

## BONNET DASH LINER

187253	Bonnet dash liner (1n rolls) .....	x	x	x	x	x	x	x	x	x
187260	Bonnet dash liner hook .....	2	2	2	2	2	2	2	2	2
3866	Washer 3/16" .....	2	2	2	2	2	2	2	2	2
7002	Nut No. 8-32 .....	2	2	2	2	2	2	2	2	2

## CABLES

167069	Body wiring cable 19 strand No. 16 (green braid) .....	x	x	x	x	x	x	x	x	x
194219	Body wiring cable 19 strand No. 14 (green braid) .....	x	x	x	x	x	-	-	x	x
166406	Body wiring cable 19 strand No. 16 (red braid) .....	x	x	x	x	x	x	x	x	x
194218	Body wiring cable 19 strand No. 14 (red braid) .....	x	x	x	x	x	-	-	x	x
166404	Body wiring cable 19 strand No. 16 (black braid) .....	x	x	x	x	x	x	x	x	x
166405	Body wiring cable 19 strand No. 16 (black with red tracer braid) .....	x	x	x	x	x	x	-	-	-
29254	Body wiring cable staple-insulated .....	x	x	x	x	x	x	x	x	x
48202	Body wiring cable terminal .....	x	x	x	x	x	x	x	x	x
333287	Body wiring cable terminal .....	x	x	x	x	x	x	x	x	x
36111	Body wiring cable terminal insulator .....	x	x	x	x	x	x	x	x	x

## CARPET

179586	Carpet folding seat floor assembly .....	-	2	2	-	-	-	-	-	-
200481	Carpet front assembly .....	-	1	1	-	-	-	-	-	-
200478	Carpet front assembly .....	-	-	-	1	-	1	-	-	-
200479	Carpet front assembly .....	-	-	-	-	-	-	1	-	-
200480	Carpet front assembly .....	-	-	-	-	1	-	-	-	-
200623	Carpet rear assembly .....	-	-	-	-	1	-	-	-	-
200621	Carpet rear assembly .....	-	1	1	-	-	-	-	-	-
200620	Carpet rear assembly .....	1	-	-	-	-	-	-	-	-
200622	Carpet rear assembly .....	-	-	-	1	-	-	-	-	-

## DICTOGRAPH

147649	Dictograph receiver .....	-	-	1	-	-	-	-	-	-
199895	Dictograph transmitter bracket .....	-	-	1	-	-	-	-	-	-
199892	Dictograph transmitter and winder assembly ...	-	-	1	-	-	-	-	-	-

## DOME LIGHT

199900	Dome light .....	1	1	-	1	1	1	-	-	-
199941	Dome light .....	-	-	1	-	-	-	-	-	-
102585	Dome light bulb Mazda No. 81 6 CP. G-6 .....	1	1	2	1	1	1	-	-	-

Piece No.	Name	No. Required								
		573	574	575	576	577	578	579	583	587
185031	Dome light door switch .....	2	2	2	2	2	2	-	-	-
199899	Dome light glass and rim .....	1	1	1	1	1	1	-	-	-
180636	Dome light reflector .....	1	1	-	1	1	1	-	-	-
185616	Dome light reflector .....	-	-	1	-	-	-	-	-	-
199913	Dome light switch 3 point .....	1	1	2	1	1	1	-	-	-

DOORS

All doors must be adjusted to each respective body. To obtain satisfactory replacement of doors, it is advisable to return the damaged door to be repaired, if possible. If this cannot be done, the customer assumes the responsibility of the new door being a satisfactory fit.

Specify on all orders the upholstery material, color of paint and striping.

NOTE:--IMPORTANT When ordering door trimmed assemblies, be sure to specify whether bottom of door is trimmed with carpet kick pad or whether upholstery cloth extends to bottom of door.

195452	Door-front left assembly-trimmed ...	1	-	-	1	1	-	-	-	-
195453	Door-front left assembly-trimmed ...	-	1	-	-	-	-	-	-	-
195454	Door-front left assembly-trimmed ...	-	-	-	1	-	-	-	-	-
195456	Door-left assembly-trimmed .....	-	-	-	-	-	1	-	-	-
195458	Door-left assembly-trimmed .....	-	-	-	-	-	-	1	-	-
195461	Door-front right assembly-trimmed ..	1	-	-	1	1	-	-	-	-
195462	Door-front right assembly-trimmed ..	-	1	-	-	-	-	-	-	-
195463	Door-front right assembly-trimmed ..	-	-	1	-	-	-	-	-	-
195465	Door-right assembly-trimmed .....	-	-	-	-	-	-	1	-	-
195467	Door-right assembly-trimmed .....	-	-	-	-	-	1	-	-	-
195470	Door-rear left assembly-trimmed ....	-	-	-	1	-	-	-	-	-
195471	Door-rear left assembly-trimmed ....	1	-	-	-	-	-	-	-	-
195473	Door-rear left assembly-trimmed ....	-	1	1	-	-	-	-	-	-
195476	Door-rear right assembly-trimmed ...	-	-	-	1	-	-	-	-	-
195477	Door-rear right assembly-trimmed ...	1	-	-	-	-	-	-	-	-
195480	Door-rear right assembly-trimmed ...	-	1	-	-	-	-	-	-	-
195481	Door-rear right assembly-trimmed ...	-	-	1	-	-	-	-	-	-

DOOR PARTS

187224	Door anti-rattle .....	4	4	4	4	2	2	2	4	2
185601	Door bumper 1-11/32" .....	x	x	x	x	x	x	x	x	x
185600	Door bumper 1-13/32" .....	x	x	x	x	x	x	x	x	x
185602	Door bumper 1-9/32" .....	x	x	x	x	x	x	x	x	x
164679	Door check strap .....	4	4	4	4	2	2	-	-	-
164700	Door check strap .....	-	-	-	-	-	-	2	2	2
164359	Door check strap fastener plate ....	4	4	4	4	2	2	2	4	2
167250	Door check strap guide .....	2	2	2	2	-	-	-	2	-
179680	Door check strap stop plate .....	2	2	2	2	2	2	2	2	2
184659	Door dove-tail-female .....	4	4	4	4	2	2	2	4	4
119298	Door dove-tail-male .....	4	4	4	4	2	2	2	4	4
185562	Door hinge-front-center left .....	1	1	1	1	1	1	-	-	-
193020	Door hinge-front-center left .....	-	-	-	-	-	-	1	1	1
185561	Door hinge-front-center right .....	1	1	1	1	1	1	-	-	-
193019	Door hinge-front-center right .....	-	-	-	-	-	-	1	1	1

Piece No.	Name	No. Required									
		573	574	575	576	577	578	579	583	587	
185568	Door hinge-front-lower left .....	1	1	1	1	1	1	-	-	-	
193105	Door hinge-front-lower left .....	-	-	-	-	-	-	1	1	-	
195751	Door hinge-front-lower left .....	-	-	-	-	-	-	-	-	1	
185567	Door hinge-front-lower right .....	1	1	1	1	1	1	-	-	-	
193104	Door hinge-front-lower right .....	-	-	-	-	-	-	1	1	-	
195750	Door hinge-front-lower right .....	-	-	-	-	-	-	-	-	1	
193018	Door hinge-front-upper left .....	-	-	-	-	-	-	1	1	1	
185566	Door hinge-front-upper left .....	1	1	1	1	1	1	-	-	-	
193017	Door hinge-front-upper right .....	-	-	-	-	-	-	1	1	1	
185565	Door hinge-front-upper right .....	1	1	1	1	1	1	-	-	-	
185557	Door hinge-rear-center right .....	1	1	1	1	-	-	-	-	-	
195754	Door hinge-rear-center right .....	-	-	-	-	-	-	-	1	-	
185558	Door hinge-rear-center left .....	1	1	1	1	-	-	-	-	-	
195755	Door hinge-rear-center left .....	-	-	-	-	-	-	-	1	-	
185560	Door hinge-rear-lower right .....	1	1	1	1	-	-	-	-	-	
195804	Door hinge-rear-lower right .....	-	-	-	-	-	-	-	1	-	
185559	Door hinge-rear-lower left .....	1	1	1	1	-	-	-	-	-	
195805	Door hinge-rear-lower left .....	-	-	-	-	-	-	-	1	-	
185555	Door hinge-rear-upper right .....	1	1	1	1	-	-	-	-	-	
195752	Door hinge-rear-upper right .....	-	-	-	-	-	-	-	1	-	
185556	Door hinge-rear-upper left .....	1	1	1	1	-	-	-	-	-	
195753	Door hinge-rear-upper left .....	-	-	-	-	-	-	-	1	-	
5697	Screw 1/4-28 x 7/16" oval hd. mach. ....	14	14	14	14	14	14	24	-	-	
5699	Screw 1/4-28 x 13/32" flat hd. mach. ....	16	16	16	16	16	16	-	-	-	
5854	Screw 1/4-28 x 1-1/4" flat hd. .	6	6	6	6	-	-	-	-	-	
5820	Screw 1/4-28 x 1-31/32" oval hd. mach. ....	6	6	6	6	-	-	-	-	-	
8211	Screw 1/4-28 x 2-1/4" flat hd. mach. ....	-	-	-	-	-	-	6	6	6	
5876	Screw 1/4-28 x 2-9/16" oval hd. mach. ....	2	2	2	2	2	2	-	-	-	
5701	Screw 1/4-28 x 9/16" flat hd. mach. ....	8	8	8	8	8	8	-	-	-	
5899	Lockwasher 5/16" .....	38	38	36	36	36	36	24	-	-	
185553	Door hinge pin .....	8	8	8	8	4	4	-	-	-	
187763	Door hinge pin .....	-	-	-	-	-	-	6	-	-	
185554	Door hinge pin .....	4	4	4	4	2	2	-	-	-	
195946	Door hinge pin 11/16" oval hd. (1/32" oversize) .....	x	x	x	x	x	x	-	-	-	
195945	Door hinge pin slotted hd. (1/32" oversize) .....	x	x	x	x	x	x	-	-	-	
187668	Door hinge pin nut .....	4	4	4	4	2	2	-	-	-	
5500	Door hinge pin lockwasher .....	4	4	4	4	2	2	-	-	-	
183170	Door lock-front right .....	1	1	1	1	1	1	1	-	1	
193054	Door lock-front right .....	-	-	-	-	-	-	-	1	-	
183171	Door lock-front left .....	1	1	1	1	1	1	1	-	1	
193021	Door lock-front left .....	-	-	-	-	-	-	-	1	-	
183171	Door lock-rear right .....	1	1	1	1	-	-	-	-	-	
193021	Door lock-rear right .....	-	-	-	-	-	-	-	1	-	
183170	Door lock-rear left .....	1	1	1	1	-	-	-	-	-	
193054	Door lock-rear left .....	-	-	-	-	-	-	-	1	-	
5829	Screw No. 10-32 x 7/8" flat hd..	8	8	8	8	4	4	4	-	-	
5491	Lockwasher 3/16" .....	8	8	8	8	4	4	4	-	-	
193695	Door lock handle-front left .....	-	-	-	-	-	-	-	1	-	
193692	Door lock handle-front right (With key lock) .....	-	-	-	-	-	-	-	1	-	
193695	Door lock handle-rear right .....	-	-	-	-	-	-	-	1	-	
193177	Door lock handle (With key lock) ...	-	-	-	-	-	-	1	-	1	
193174	Door lock handle .....	-	-	-	-	-	-	1	-	1	
185828	Door lock handle-front left .....	1	1	1	1	1	1	-	-	-	
185828	Door lock handle-rear right .....	1	1	-	1	-	-	-	-	-	
185736	Door lock handle-rear left .....	1	1	1	1	-	-	-	-	-	
193696	Door lock handle-rear left .....	-	-	-	-	-	-	-	1	-	
185734	Door lock handle-front right (With key lock) .....	1	1	1	1	1	1	-	-	-	
185735	Door lock handle-rear right (With key lock) .....	-	-	1	-	-	-	-	-	-	
187685	Door lock handle screw .....	1	1	2	1	1	1	1	-	1	
195236	Washer .....	1	1	2	1	1	1	1	-	1	

Piece No.	Name	No. Required									
		573	574	575	576	577	578	579	583	587	
193076	Door lock remote control-right .....	-	-	-	-	-	-	-	1	-	-
185710	Door lock remote control-right .....	-	-	-	-	-	-	-	-	2	1
193075	Door lock remote control-left .....	-	-	-	-	-	-	-	1	-	-
185711	Door lock remote control-left .....	-	-	-	-	-	-	-	-	2	1
185701	Door lock remote control-front right .....	1	1	1	1	1	1	-	-	-	-
185697	Door lock remote control-front left .....	1	1	1	1	1	1	-	-	-	-
185713	Door lock remote control-front right .....	-	1	1	-	-	-	-	-	-	-
185712	Door lock remote control-front left .....	-	1	1	-	-	-	-	-	-	-
185650	Door lock remote control-rear right .....	1	1	1	1	-	-	-	-	-	-
185700	Door lock remote control-rear left .....	1	1	1	1	-	-	-	-	-	-
185710	Door lock remote control-rear right .....	-	1	1	-	-	-	-	-	-	-
185711	Door lock remote control-rear left .....	-	1	1	-	-	-	-	-	-	-
199914	Door lock remote control handle .....	4	4	4	4	2	2	4	2	2	-
187984	Door lock remote control handle escutcheon plate .....	4	4	4	4	2	2	2	4	2	-
193077	Door lock remote control handle escutcheon plate spring .....	4	4	4	4	2	2	2	4	2	-
182386	Door lock striker .....	4	4	4	4	-	-	-	-	-	-
170689	Door lock striker .....	-	-	-	-	2	2	-	-	-	-
195796	Door lock striker .....	-	-	-	-	-	-	-	2	-	-
193165	Door lock striker .....	-	-	-	-	-	-	2	-	2	-
170336	Door lock striker nut .....	2	2	2	2	-	-	-	-	-	-
182387	Door lock striker adjusting plate .....	4	4	4	4	-	-	-	-	-	-
170335	Door lock striker screw .....	2	2	2	2	-	-	-	-	-	-
195781	Door scuff plate-front left .....	-	-	-	-	-	-	1	-	-	-
185715	Door scuff plate-front left .....	-	1	1	-	-	-	-	-	-	-
185585	Door scuff plate-front left .....	1	-	-	1	1	1	-	-	-	-
195778	Door scuff plate-right .....	-	-	-	-	-	-	-	-	1	-
195779	Door scuff plate-left .....	-	-	-	-	-	-	-	-	-	1
193124	Door scuff plate-right .....	-	-	-	-	-	-	1	-	-	-
193123	Door scuff plate-left .....	-	-	-	-	-	-	1	-	-	-
195780	Door scuff plate-front right .....	-	-	-	-	-	-	-	1	-	-
185716	Door scuff plate-front right .....	-	1	1	-	-	-	-	-	-	-
185586	Door scuff plate-front right .....	1	-	-	1	1	1	-	-	-	-
195787	Door scuff plate-rear left .....	-	-	-	-	-	-	-	1	-	-
185646	Door scuff plate-rear left .....	1	-	-	1	-	-	-	-	-	-
185778	Door scuff plate-rear left .....	-	1	1	-	-	-	-	-	-	-
195786	Door scuff plate-rear right .....	-	-	-	-	-	-	-	1	-	-
185779	Door scuff plate-rear right .....	-	1	1	-	-	-	-	-	-	-
185647	Door scuff plate-rear right .....	1	-	-	1	-	-	-	-	-	-
193235	Door weatherstrip-front right .....	-	-	-	-	-	-	1	-	-	-
193234	Door weatherstrip-front left .....	-	-	-	-	-	-	1	-	-	-
193229	Door weatherstrip-rear right .....	-	-	-	-	-	-	1	-	-	-
193535	Door weatherstrip-rear left .....	-	-	-	-	-	-	1	-	-	-
193233	Door weatherstrip-upper front right .....	-	-	-	-	-	-	1	-	-	-
193232	Door weatherstrip-upper front left .....	-	-	-	-	-	-	1	-	-	-
193231	Door weatherstrip-upper rear right .....	-	-	-	-	-	-	1	-	-	-
193230	Door weatherstrip-upper rear left .....	-	-	-	-	-	-	1	-	-	-

## FASTENERS

195341	Fastener-stud screw base top rear curtain ....	-	-	-	-	-	-	x	-	-	-
193199	Snap fastener rivet post-female-carpet .....	x	x	x	x	x	x	x	-	-	-
193200	Snap fastener machine screw post-carpet .....	x	x	x	x	x	x	x	-	-	-
193201	Snap fastener screw post-carpet .....	x	x	x	x	x	x	x	-	-	-
159060	Snap fastener screw stud-carpet .....	x	x	x	x	x	x	x	-	-	-
115798	Snap fastener socket ring-carpet-short prong .	x	x	x	x	x	x	x	-	-	-
115799	Snap fastener socket-carpet .....	x	x	x	x	x	x	x	-	-	-
185412	Snap fastener wood screw stud front seat back rail .....	-	-	-	-	-	-	x	-	-	-



Piece No.	Name	No. Required								
		573	574	575	576	577	578	579	583	587
139150	Snap fastener socket-top envelope .....	-	-	-	-	-	-	x	-	-
139150	Snap fastener socket-top side rail .....	-	-	-	-	-	-	x	-	-
139150	Snap fastener socket body lock pillar .....	-	-	-	-	-	-	x	-	-
139157	Snap fastener rivet stud-top side quarter ....	-	-	-	-	-	-	x	-	-
139157	Snap fastener rivet stud-top envelope .....	-	-	-	-	-	-	x	-	-
139159	Snap fastener rivet post-top envelope .....	-	-	-	-	-	-	x	-	-
175757	Snap fastener rivet post-top envelope .....	-	-	-	-	-	-	x	-	-

## FLOOR BOARD

185702	Floor board front assembly .....	1	-	-	1	-	1	1	1	-
187943	Floor board front assembly .....	-	-	-	-	1	-	-	-	1
185703	Floor board front assembly .....	-	1	1	-	-	-	-	-	-
187946	Floor board front filler .....	-	-	-	-	1	-	-	-	1
185705	Floor board front filler .....	-	1	1	-	-	-	-	-	-
185704	Floor board front filler .....	1	-	-	1	-	1	1	1	-
195242	Floor board front felt-center .....	1	1	1	1	1	1	1	1	1
187634	Floor board front felt-front center .....	1	1	1	1	1	1	1	1	1
187631	Floor board front felt-front side .....	2	2	2	2	2	2	2	2	2
185709	Floor board front felt-rear .....	1	1	1	1	1	1	1	1	1
187632	Floor board front felt-side .....	2	-	-	2	-	2	2	2	-
187633	Floor board front felt-side .....	-	2	2	-	-	-	-	-	-
187949	Floor board front felt-side .....	-	-	-	-	2	-	-	-	2
185719	Floor board rear assembly .....	1	1	1	-	-	-	-	-	-

## FOLDING SEAT

187280	Folding seat trimmed assembly .....	-	2	2	-	-	-	-	-	-
187498	Folding seat untrimmed assembly .....	-	2	2	-	-	-	-	-	-
169102	Folding seat back untrimmed assembly .....	-	2	2	-	-	-	-	-	-
187945	Folding seat back to seat frame screw .....	-	4	4	-	-	-	-	-	-
187417	Folding seat floor plate .....	-	1	1	-	-	-	-	-	-
171692	Folding seat frame assembly .....	-	2	2	-	-	-	-	-	-
5580	Screw No. 10-32 x 1" flat hd. mach. ....	-	16	16	-	-	-	-	-	-
5229	Screw 1/4-28 x 1-3/8" flat hd. mach. ....	-	8	8	-	-	-	-	-	-
8220	Screw 1/4-28 x 1-1/2" flat hd. mach. ....	-	8	8	-	-	-	-	-	-
7003	Nut No. 10-32 .....	-	16	16	-	-	-	-	-	-
7004	Nut 1/4"-28 .....	-	16	16	-	-	-	-	-	-
3867	Washer 3/16" .....	-	4	4	-	-	-	-	-	-
171698	Folding seat frame side-left .....	-	2	2	-	-	-	-	-	-
171703	Folding seat frame side-right .....	-	2	2	-	-	-	-	-	-
199916	Folding seat handle .....	-	2	2	-	-	-	-	-	-
100100	Folding seat pivot pin .....	-	4	4	-	-	-	-	-	-
187421	Folding seat pivot pin retainer .....	-	2	2	-	-	-	-	-	-
8204	Screw 1/4-28 x 2" flat hd. mach. ....	-	4	4	-	-	-	-	-	-
187410	Folding seat support-left .....	-	2	2	-	-	-	-	-	-
187411	Folding seat support-right .....	-	2	2	-	-	-	-	-	-
130869	Folding seat support to seat frame screw .....	-	4	4	-	-	-	-	-	-
7006	Nut 3/8"-24 .....	-	4	4	-	-	-	-	-	-
5506	Lockwasher 3/8" .....	-	4	4	-	-	-	-	-	-

## FOOT REST

187113	Foot rest assembly .....	1	1	1	-	-	-	-	-	-
79574	Foot rest assembly .....	-	-	-	-	-	1	1	-	-
122146	Foot rest pivot stud .....	-	-	-	-	-	2	2	-	-
147963	Foot rest pivot stud .....	2	2	2	-	-	-	-	2	-
180134	Nut .....	2	2	2	-	-	2	2	-	-

Piece No.	Name	No. Required								
		573	574	575	576	577	578	579	583	587
<b>FRONT SEAT</b>										
142793	Front seat back compartment lid hinge .....	-	-	-	-	-	1	-	-	-
122611	Front seat back compartment lid hinge .....	-	-	-	-	-	-	2	-	-
114525	Front seat back compartment lid lifter .....	-	-	-	-	-	1	-	-	-
181695	Front seat-right-counterbalance assembly .....	-	-	-	-	1	-	-	-	-
5823	Screw 1/4-28 x 1-1/8" oval hd. mach. ....	-	-	-	-	3	-	-	-	-
5502	Lockwasher 1/4" .....	-	-	-	-	3	-	-	-	-
7004	Nut 1/4"-28 .....	-	-	-	-	3	-	-	-	-
62065	Washer 1/4" .....	-	-	-	-	3	-	-	-	-
181703	Front seat-right-counterbalance spring-left ..	-	-	-	-	1	-	-	-	-
181702	Front seat-right-counterbalance spring-right ..	-	-	-	-	1	-	-	-	-
181989	Front seat-right-counterbalance spring adjusting lever .....	-	-	-	-	2	-	-	-	-
181697	Front seat-right-counterbalance spring lever and pin assembly .....	-	-	-	-	1	-	-	-	-
5822	Front seat-right-counterbalance spring adjusting lever screw 1/4-28 x 5/8" hex. hd. mach. ....	-	-	-	-	2	-	-	-	-
5502	Lockwasher 1/4" .....	-	-	-	-	2	-	-	-	-
7004	Nut 1/4"-28 .....	-	-	-	-	2	-	-	-	-
179717	Front seat-left-frame carrier bracket .....	1	1	-	1	-	1	-	-	-
187738	Front seat-left-frame carrier bracket .....	-	-	-	-	-	-	1	-	-
4242	Rivet 3/16" x 1/2" .....	10	10	-	10	-	10	10	-	-
7610	Front seat hinge bolt 1/4-28 x 2-1/8" common carriage .....	-	-	-	-	8	-	-	-	-
5817	Lockwasher 1/4" .....	-	-	-	-	8	-	-	-	-
7004	Nut 1/4"-28 .....	-	-	-	-	8	-	-	-	-
173150	Front seat-left-locking lever .....	-	-	-	-	1	-	-	-	-
173513	Front seat-left-locking lever pin .....	-	-	-	-	1	-	-	-	-
173148	Front seat-left-locking lever bracket .....	-	-	-	-	1	-	-	-	-
173313	Front seat-left-locking lever spring .....	-	-	-	-	1	-	-	-	-
180842	Front seat-left-locking stud .....	1	1	-	1	-	1	-	-	-
183528	Front seat-left-locking spring .....	1	1	-	1	-	1	-	-	-
187739	Front seat-left-locking spring .....	-	-	-	-	-	-	1	1	-
187736	Front seat-left-operating handle assembly ....	-	-	-	-	-	-	1	1	-
146103	Spring .....	-	-	-	-	-	-	1	1	-
3912	Washer 7/16" .....	-	-	-	-	-	-	1	1	-
4290	Pin 3/32" x 5/8" spring cotter .....	-	-	-	-	-	-	1	1	-
5502	Lockwasher 1/4" .....	-	-	-	-	-	-	1	1	-
7004	Nut 1/4"-28 .....	-	-	-	-	-	-	1	1	-
187740	Front seat-left-operating shaft cam .....	-	-	-	-	-	-	1	1	-
180666	Front seat-left-operating spring .....	1	1	-	1	-	1	1	1	-
180845	Front seat-left-support bar assembly .....	1	1	-	1	-	1	-	-	-
180844	Front seat-left-support bar handle .....	1	1	-	1	-	1	-	-	-

**GOLF COMPARTMENT**

193310	Golf compartment door trimmed assembly .....	-	-	-	-	-	1	1	-	-
111671	Golf compartment door bumper .....	-	-	-	-	-	2	2	-	-
111672	Golf compartment door bumper socket .....	-	-	-	-	-	2	2	-	-
163766	Golf compartment door hinge .....	-	-	-	-	-	1	1	-	-
163767	Golf compartment door lock .....	-	-	-	-	-	1	1	-	-
143615	Golf compartment door lock striker .....	-	-	-	-	-	1	1	-	-

**GRIP HANDLE**

199918	Grip handle .....	-	2	2	-	-	-	-	-	-
--------	-------------------	---	---	---	---	---	---	---	---	---

Piece No.	Name	No. Required								
		573	574	575	576	577	578	579	583	587
<b>HASSOCK</b>										
135807	Hassock .....	-	-	-	2	-	-	-	-	-
<b>INSTRUMENT BOARD</b>										
201225	Instrument board assembly .....	1	1	1	1	1	1	1	1	1
187936	Instrument board compartment door frame assembly-right .....	1	1	1	1	1	1	1	1	1
187935	Instrument board compartment door frame assembly-left .....	1	1	1	1	1	1	1	1	1
5724	Screw No. 8-32 x 3/8" oval hd. ....	4	4	4	4	4	4	4	4	4
5860	Washer No. 8 .....	4	4	4	4	4	4	4	4	4
185893	Instrument board compartment door anti-rattler	2	2	2	2	2	2	2	2	2
180307	Instrument board compartment door hinge asb. .	2	2	2	2	2	2	2	2	2
5859	Rivet 3/16 x 5/16" tub. rnd. hd. ....	4	4	4	4	4	4	4	4	4
187495	Instrument board compartment door knob .....	2	2	2	2	2	2	2	2	2
5569	Screw No. 10-32 x 1/2" fill. hd. mach. ...	2	2	2	2	2	2	2	2	2
5500	Lockwasher 1/4" .....	2	2	2	2	2	2	2	2	2
184753	Instrument board compartment door panel assembly-right .....	1	1	1	1	1	1	1	1	1
184754	Instrument board compartment door panel assembly-left .....	1	1	1	1	1	1	1	1	1
105029	Instrument board compartment door spring dowel	2	2	2	2	2	2	2	2	2
180301	Instrument board compartment door striker plate .....	2	2	2	2	2	2	2	2	2
141049	Rivet 3/16" x 1/4" rnd. hd. tub. ....	4	4	4	4	4	4	4	4	4
190674	Instrument board steering post bracket support	1	1	1	1	1	1	1	1	1
5764	Screw 1/4-28 x 3/4" O.H. mach. ....	2	2	2	2	2	2	2	2	2
5471	Screw 1/4-28 x 5/8" hex. hd. ....	2	2	2	2	2	2	2	2	2
3868	Washer 1/4" .....	2	2	2	2	2	2	2	2	2
5502	Lockwasher 1/4" .....	4	4	4	4	4	4	4	4	4
7004	Nut 1/4"-28 .....	2	2	2	2	2	2	2	2	2
187416	Instrument board steering post bracket support liner .....	1	1	1	1	1	1	1	1	1
<b>MOULDING</b>										
193990	Moulding cowl rail finishing .....	-	-	-	-	-	-	1	1	1
185771	Moulding cowl rail finishing .....	1	1	1	1	1	1	-	-	-
195768	Moulding door window finishing-right .....	-	-	-	-	-	-	-	-	1
193079	Moulding door window finishing-right .....	-	-	-	-	-	-	1	-	-
195760	Moulding door window finishing-front right ...	-	-	-	-	-	-	-	1	-
193080	Moulding door window finishing-left .....	-	-	-	-	-	-	1	-	-
195769	Moulding door window finishing-left .....	-	-	-	-	-	-	-	-	1
195781	Moulding door window finishing-front left ....	-	-	-	-	-	-	-	1	-
185812	Moulding door window finishing-front upper right .....	-	1	1	-	-	-	-	-	-
185813	Moulding door window finishing-front upper left .....	-	1	1	-	-	-	-	-	-
185755	Moulding door window finishing-front lower right .....	-	1	1	-	-	-	-	-	-
187147	Moulding door window finishing-front lower right .....	1	-	-	1	1	1	-	-	-
185756	Moulding door window finishing-front lower left .....	-	1	1	-	-	-	-	-	-
187148	Moulding door window finishing-front lower left .....	1	-	-	1	1	1	-	-	-

Piece No.	Name	No. Required									
		573	574	575	576	577	578	579	583	587	
195766	Moulding door window finishing-rear right ....	-	-	-	-	-	-	-	-	1	-
195767	Moulding door window finishing-rear left .....	-	-	-	-	-	-	-	-	1	-
187007	Moulding door window finishing-rear upper ....	-	2	2	-	-	-	-	-	-	-
185757	Moulding door window finishing-rear lower ....	-	2	2	-	-	-	-	-	-	-
187017	Moulding door window finishing-rear lower right .....	2	-	-	2	-	-	-	-	-	-
187124	Moulding door window finishing-front side- front right .....	1	1	1	1	1	1	-	-	-	-
187125	Moulding door window finishing-front side- front left .....	1	1	1	1	1	1	-	-	-	-
195772	Moulding door window finishing panel-right ...	-	-	-	-	-	-	-	-	-	1
195773	Moulding door window finishing panel-left ....	-	-	-	-	-	-	-	-	-	1
185998	Moulding door window finishing panel-front right .....	1	-	-	1	1	1	-	-	-	-
185999	Moulding door window finishing panel-front left .....	1	-	-	1	1	1	-	-	-	-
185671	Moulding door window finishing panel-front right .....	-	1	1	-	-	-	-	-	-	-
185672	Moulding door window finishing panel-front left .....	-	1	1	-	-	-	-	-	-	-
187012	Moulding door window finishing panel-rear right .....	1	-	-	1	-	-	-	-	-	-
187013	Moulding door window finishing panel-rear left .....	1	-	-	1	-	-	-	-	-	-
185670	Moulding door window finishing panel-rear right .....	-	1	1	-	-	-	-	-	-	-
185669	Moulding door window finishing-rear left ....	-	1	1	-	-	-	-	-	-	-
187549	Moulding door window finishing-side .....	3	3	3	3	1	-	-	-	-	-
187988	Moulding door window finishing-side rear right	-	-	-	-	-	1	-	-	-	-
187989	Moulding door window finishing-side rear left.	-	-	-	-	-	1	-	-	-	-
187550	Moulding door window finishing-side .....	3	3	3	3	1	-	-	-	-	-
187146	Moulding door window finishing-front upper left .....	1	-	-	1	1	-	-	-	-	-
187145	Moulding door window finishing-front upper right .....	1	-	-	1	1	-	-	-	-	-
187991	Moulding door window finishing-upper left ....	-	-	-	-	-	1	-	-	-	-
187990	Moulding door window finishing-upper right ...	-	-	-	-	-	1	-	-	-	-
187016	Moulding door window finishing-rear upper ....	2	-	-	2	-	-	-	-	-	-
185767	Moulding front pillar finishing-right .....	1	1	1	1	1	1	-	-	-	-
185768	Moulding front pillar finishing-left .....	1	1	1	1	1	1	-	-	-	-
185911	Moulding partition window finishing-lower ....	-	-	1	-	-	-	-	-	-	-
185879	Moulding partition window finishing panel ....	-	-	1	-	-	-	-	-	-	-
187582	Moulding partition window finishing-side right	-	-	1	-	-	-	-	-	-	-
187583	Moulding partition window finishing-side left.	-	-	1	-	-	-	-	-	-	-
187584	Moulding partition window finishing-upper ....	-	-	1	-	-	-	-	-	-	-
187654	Moulding rain gutter-left (89" long) .....	1	-	-	-	-	-	-	-	-	-
187657	Moulding rain gutter-left (101" long) .....	-	1	1	-	-	-	-	-	-	-
193312	Moulding rain gutter-left (38 1/2" long) .....	-	-	-	-	-	1	-	-	-	-
187659	Moulding rain gutter-left (70" long) .....	-	-	-	1	-	-	-	-	-	-
193314	Moulding rain gutter-left (65 1/2" long) .....	-	-	-	-	1	-	-	-	-	-
187653	Moulding rain gutter-right (89" long) .....	1	-	-	-	-	-	-	-	-	-
187658	Moulding rain gutter-right (101" long) .....	-	1	1	-	-	-	-	-	-	-
193313	Moulding rain gutter-right (38 1/2" long) ....	-	-	-	-	-	1	-	-	-	-
193315	Moulding rain gutter-right (65 1/2" long) ....	-	-	-	-	1	-	-	-	-	-
187660	Moulding rain gutter-right (70" long) .....	-	-	-	1	-	-	-	-	-	-
193317	Screw No. 4 x 1/2" (Parker-Kalon special) flat head .....	4	4	4	4	4	4	-	-	-	-
166426	Moulding rear platform (44 1/2" long) .....	-	-	-	1	-	-	-	-	-	-
193120	Moulding rear window finishing-lower .....	1	1	1	1	1	1	-	-	-	-
193122	Moulding rear window finishing-upper .....	-	-	-	-	-	1	-	-	-	-
185758	Moulding rear window finishing-upper .....	1	1	1	1	1	-	-	-	-	-

Piece No.	Name	No. Required								
		573	574	575	576	577	578	579	583	587
187552	Moulding side window finishing-front right ...	1	1	1	-	1	-	-	-	-
187551	Moulding side window finishing-front left ....	1	1	1	-	1	-	-	-	-
187897	Moulding side window finishing-lower right ...	-	-	-	-	1	-	-	-	-
187898	Moulding side window finishing-lower left ....	-	-	-	-	1	-	-	-	-
185662	Moulding side window finishing-lower right ...	-	1	1	-	-	-	-	-	-
185661	Moulding side window finishing-lower left ....	-	1	1	-	-	-	-	-	-
185928	Moulding side window finishing-lower .....	2	-	-	-	-	-	-	-	-
185972	Moulding side window finishing panel-right ...	1	-	-	-	-	-	-	-	-
187916	Moulding side window finishing panel-right ...	-	-	-	-	1	-	-	-	-
185674	Moulding side window finishing panel-right ...	-	1	1	-	-	-	-	-	-
185675	Moulding side window finishing panel-left ....	-	1	1	-	-	-	-	-	-
187917	Moulding side window finishing panel-left ....	-	-	-	-	1	-	-	-	-
185973	Moulding side window finishing panel-left ....	1	-	-	-	-	-	-	-	-
185927	Moulding side window finishing-rear right ....	1	-	-	-	-	-	-	-	-
187899	Moulding side window finishing-rear right ....	-	-	-	-	1	-	-	-	-
185664	Moulding side window finishing-rear right ....	-	1	1	-	-	-	-	-	-
185926	Moulding side window finishing-rear left .....	1	-	-	-	-	-	-	-	-
187900	Moulding side window finishing-rear left .....	-	-	-	-	1	-	-	-	-
185663	Moulding side window finishing-rear left .....	-	1	1	-	-	-	-	-	-
5768	Screw No. 4-40 x 7/8" oval hd. mach. ....	6	6	6	6	6	6	-	-	-
8020	Screw No. 4-40 x 1/2" oval hd. mach. ....	6	6	6	6	6	6	-	-	-
33170	Wood screw ferrule .....	x	x	x	x	x	x	-	-	-

PANEL

199850	Panel-cowl assembly .....	1	1	1	1	1	1	-	1	1
199851	Panel-cowl assembly .....	-	-	-	-	-	-	1	-	-
199848	Panel-dash assembly .....	1	1	1	1	1	1	1	1	1
199748	Panel-dash cover assembly .....	1	1	1	1	1	1	1	1	1
199709	Panel-dash interliner .....	1	1	1	1	1	1	1	1	1
199707	Panel-dash liner .....	1	1	1	1	1	1	1	1	1
185956	Panel-door right assembly .....	-	-	-	-	-	1	-	-	-
195692	Panel-door right assembly .....	-	-	-	-	-	1	-	-	-
185957	Panel-door left assembly .....	-	-	-	-	-	1	-	-	-
195691	Panel-door left assembly .....	-	-	-	-	-	1	-	-	-
185958	Panel-door front right assembly .....	1	1	1	1	1	-	-	-	-
185948	Panel-door front right assembly .....	-	1	1	-	-	-	-	-	-
185959	Panel-door front left assembly .....	1	1	1	1	1	-	-	-	-
185949	Panel-door front left assembly .....	-	1	1	-	-	-	-	-	-
185962	Panel-door rear right assembly .....	-	-	-	1	-	-	-	-	-
185960	Panel-door rear right assembly .....	1	1	1	-	-	-	-	-	-
185950	Panel-door rear right assembly .....	-	1	1	-	-	-	-	-	-
185951	Panel-door rear left assembly .....	-	1	1	-	-	-	-	-	-
185961	Panel-door rear left assembly .....	1	1	1	-	-	-	-	-	-
185963	Panel-door rear left assembly .....	-	-	-	1	-	-	-	-	-

REAR COMPARTMENT

173312	Rear compartment door assembly .....	-	-	-	-	1	-	-	-	-
122213	Rear compartment door brace assembly .....	-	-	-	-	1	-	-	-	-
5676	Screw No. 10-32 x 3/8" .....	-	-	-	-	1	-	-	-	-
5500	Lockwasher No. 10 .....	-	-	-	-	1	-	-	-	-
7003	Nut No. 10-32 .....	-	-	-	-	1	-	-	-	-
111687	Rear compartment door bumper .....	-	-	-	-	2	-	-	-	-
172133	Rear compartment door drain gutter assembly ..	-	-	-	-	1	-	-	-	-
158994	Rear compartment door hinge .....	-	-	-	-	2	-	-	-	-
5684	Bolt 1/4-28 x 1-7/8" common carriage .....	-	-	-	-	4	-	-	-	-
5502	Lockwasher 1/4" .....	-	-	-	-	4	-	-	-	-
7004	Nut 1/4"-28 .....	-	-	-	-	4	-	-	-	-

Piece No.	Name	No. Required								
		573	574	575	576	577	578	579	583	587
102590	Rear compartment light bulb-7V.3 C.P.G-6 single contact .....	-	-	-	-	1	-	-	-	-
107654	Rear compartment light disconnecter plug socket .....	-	-	-	-	1	-	-	-	-
136593	Rear compartment light switch (2 point) .....	-	-	-	-	1	-	-	-	-
176282	Rear compartment door lock .....	-	-	-	-	1	-	-	-	-
176207	Rear compartment door lock handle (with key lock) .....	-	-	-	-	1	-	-	-	-
8018	Screw No. 8-32 x 7/16" oval head.....	-	-	-	-	1	-	-	-	-
184249	Washer .....	-	-	-	-	1	-	-	-	-
5581	Lockwasher 5/32" .....	-	-	-	-	1	-	-	-	-
176307	Rear compartment door lock striker .....	-	-	-	-	1	-	-	-	-
187828	Rear compartment door weatherstrip-long .....	-	-	-	-	2	-	-	-	-
187829	Rear compartment door weatherstrip-short .....	-	-	-	-	2	-	-	-	-

### REAR QUARTER LIGHT

199905	Rear quarter light .....	2	2	2	2	2	2	-	-	-
102590	Rear quarter light bulb 7V. 3 C.P. G-6 single contact .....	2	2	2	2	2	2	-	-	-
199906	Rear quarter light glass and rim .....	2	2	2	2	2	2	-	-	-
180638	Rear quarter light reflector .....	2	2	2	2	2	2	-	-	-
199917	Rear quarter light switch .....	1	1	1	1	1	1	-	-	-

### REAR VIEW MIRROR

193462	Rear view mirror assembly .....	-	-	-	-	-	-	1	1	1
179526	Rear view mirror assembly .....	1	1	1	1	1	1	-	-	-
5631	Screw No. 10-32 x 1/4" rnd. hd. ....	-	-	-	-	-	-	2	2	2
187293	Rear view mirror bracket assembly .....	1	1	1	1	1	1	-	-	-
191368	Rear view mirror glass.....	-	-	-	-	-	-	1	1	1
191367	Rear view mirror glass .....	1	1	1	1	1	1	-	-	-

### ROBE RAIL

199919	Robe rail assembly .....	1	-	-	1	-	-	-	-	-
199890	Robe rail complete .....	-	1	1	-	-	-	-	-	-
187913	Robe rail assembly .....	-	1	1	-	-	-	-	-	-
98648	Bracket .....	-	2	2	-	-	-	-	-	-

### RUMBLE SEAT

157018	Rumble seat compartment door bumper .....	-	-	-	-	-	2	2	-	-
187730	Rumble seat compartment door hinge-right .....	-	-	-	-	-	1	1	-	-
187729	Rumble seat compartment door hinge-left .....	-	-	-	-	-	1	1	-	-
7604	Bolt 1/4-28 x 1-5/8" carriage common .....	-	-	-	-	-	6	6	-	-
7004	Nut 1/4"-28 .....	-	-	-	-	-	6	6	-	-
5502	Lockwasher 1/4" .....	-	-	-	-	-	6	6	-	-
196243	Rumble seat compartment door operating spring .....	-	-	-	-	-	2	2	-	-
157584	Rumble seat compartment door operating bolt .....	-	-	-	-	-	2	2	-	-
7174	Nut 1/4"-28 castle .....	-	-	-	-	-	2	2	-	-
4280	Cotter pin 1/16 x 1/2" .....	-	-	-	-	-	2	2	-	-
157585	Rumble seat compartment door operating spring washer .....	-	-	-	-	-	2	2	-	-
127501	Rumble seat compartment door hinge bushing ...	-	-	-	-	-	2	2	-	-
127498	Rumble seat compartment door hinge screw .....	-	-	-	-	-	2	2	-	-
3884	Washer 1/2" .....	-	-	-	-	-	2	2	-	-
5510	Lockwasher 1/2" .....	-	-	-	-	-	2	2	-	-

Piece No.	Name	No. Required								
		573	574	575	576	577	578	579	583	587
157625	Rumble seat compartment door lock striker ....	-	-	-	-	-	1	1	-	-
187773	Rumble seat compartment drain gutter assembly.	-	-	-	-	-	1	1	-	-
102590	Rumble seat compartment light bulb 7V. 3 C.P. G-6 single contact .....	-	-	-	-	-	1	1	-	-
107654	Rumble seat compartment light disconnecter plug socket .....	-	-	-	-	-	1	1	-	-
136593	Rumble seat compartment light switch (2 point)	-	-	-	-	-	1	1	-	-
148338	Rumble seat door lock .....	-	-	-	-	-	1	-	-	-
204552	Rumble seat door lock assembly .....	-	-	-	-	-	-	1	-	-
193062	Rumble seat door lock operating cable assembly	-	-	-	-	-	-	1	-	-
7513	Yoke end adj. 3/16" (S.A.E.) .....	-	-	-	-	-	-	1	-	-
7523	Yoke end pin 3/16" .....	-	-	-	-	-	-	1	-	-
3906	Washer 3/16" .....	-	-	-	-	-	-	2	-	-
4690	Pin 1/16 x 3/8" spring cotter .....	-	-	-	-	-	-	1	-	-
147406	Clip .....	-	-	-	-	-	-	2	-	-
8207	Screw No. 10-32 x 3/4" flat hd. mach. ....	-	-	-	-	-	-	1	-	-
5500	Lockwasher No. 10 .....	-	-	-	-	-	-	1	-	-
7003	Nut No. 10 .....	-	-	-	-	-	-	1	-	-
193063	Rumble seat door lock operating handle .....	-	-	-	-	-	-	1	-	-
148339	Rumble seat door lock operating lever .....	-	-	-	-	-	1	-	-	-
187889	Rumble seat door lock operating rod and yoke end assembly .....	-	-	-	-	-	1	-	-	-
7513	Yoke end adj. 3/16" .....	-	-	-	-	-	1	-	-	-
7003	Nut No. 10 .....	-	-	-	-	-	1	-	-	-
7523	Yoke end pin 3/16" .....	-	-	-	-	-	3	-	-	-
3906	Washer-plain 3/16" .....	-	-	-	-	-	4	-	-	-
4690	Pin-cotter spring 1/16 x 3/8" .....	-	-	-	-	-	3	-	-	-
193221	Rumble seat step bracket-upper .....	-	-	-	-	-	1	1	-	-
193421	Rumble seat step-lower (side wheel carrier) ..	-	-	-	-	-	1	1	-	-
193278	Rumble seat step-lower (rear wheel carrier) ..	-	-	-	-	-	1	1	-	-
175144	Rumble seat step lower clamp plate .....	-	-	-	-	-	2	2	-	-
7859	Screw 1/4-28 x 1-1/2" hex. hd. mach. ....	-	-	-	-	-	2	2	-	-
7842	Screw 1/4-28 x 1-1/4" hex. hd. mach. ....	-	-	-	-	-	2	2	-	-
5502	Lockwasher 1/4" std. ....	-	-	-	-	-	4	4	-	-
7004	Nut 1/4"-28 .....	-	-	-	-	-	4	4	-	-
193271	Rumble seat step-upper .....	-	-	-	-	-	1	1	-	-
6116	Stud 3/8" .....	-	-	-	-	-	3	3	-	-
114055	Washer 25/64 x 3/4 x 5/32" .....	-	-	-	-	-	3	3	-	-
5506	Lockwasher 3/8" .....	-	-	-	-	-	3	3	-	-
7006	Nut 3/8"-24 .....	-	-	-	-	-	3	3	-	-
7811	Screw 5/16-24 x 1-3/8" hex. hd. mach. ....	-	-	-	-	-	2	2	-	-
5504	Lockwasher 5/16" .....	-	-	-	-	-	2	2	-	-
179123	Rumble seat step upper liner .....	-	-	-	-	-	1	1	-	-

## SEAT CUSHION AND SPRING

181966	Seat back spring-front .....	-	-	1	-	-	-	-	-	-
195249	Seat back spring-front .....	-	-	-	-	2	-	-	-	-
195238	Seat back spring-front right .....	1	1	-	1	-	1	-	-	-
193071	Seat back spring-front right .....	-	-	-	-	-	-	1	-	-
195236	Seat back spring-front left .....	1	1	-	1	-	1	-	-	-
193070	Seat back spring-front left .....	-	-	-	-	-	-	1	-	-
195248	Seat back spring-rear left .....	-	-	-	-	1	-	-	-	-
195241	Seat back spring-rear left .....	-	1	1	-	-	-	-	-	-
195244	Seat back spring-rear left .....	1	-	-	-	-	-	-	-	-
195246	Seat back spring-rear left .....	-	-	-	1	-	-	-	-	-
195240	Seat back spring-rear right .....	-	1	1	-	-	-	-	-	-
195243	Seat back spring-rear right .....	1	-	-	-	-	-	-	-	-
195245	Seat back spring-rear right .....	-	-	-	1	-	-	-	-	-
195247	Seat back spring-rear right .....	-	-	-	-	1	-	-	-	-



Piece No.	Name	No. Required									
		573	574	575	576	577	578	579	583	587	
193069	Seat back spring-rumble seat .....	-	-	-	-	-	1	1	-	-	
187259	Seat cushion assembly-front .....	-	-	1	-	-	-	-	-	-	
193293	Seat cushion assembly-front left .....	-	-	-	-	-	-	1	-	-	
193295	Seat cushion assembly-front left .....	-	-	-	-	1	-	-	-	-	
187337	Seat cushion assembly-front left .....	1	1	-	1	-	1	-	-	-	
193297	Seat cushion assembly-front right .....	-	-	-	-	-	-	1	-	-	
193299	Seat cushion assembly-front right .....	-	-	-	-	1	-	-	-	-	
187338	Seat cushion assembly-front right .....	1	1	-	1	-	1	-	-	-	
200628	Seat cushion assembly-rear .....	-	1	1	-	-	-	-	-	-	
200630	Seat cushion assembly-rear (with angle set axle) .....	-	-	-	-	-	-	-	-	-	
200631	Seat cushion assembly-rear (with angle set axle) .....	-	-	-	1	-	-	-	-	-	
187453	Seat cushion assembly-rear (use with standard rear axle) .....	1	-	-	-	-	-	-	-	-	
187454	Seat cushion assembly-rear (use with standard rear axle).....	-	-	-	1	-	-	-	-	-	
200629	Seat cushion assembly-rear .....	-	-	-	-	1	-	-	-	-	
193027	Seat cushion assembly-rumble seat (with standard rear axle) .....	-	-	-	-	-	1	1	-	-	
204197	Seat cushion assembly-rumble seat (with angle set axle) .....	-	-	-	-	-	1	1	-	-	
181965	Seat cushion spring-front right .....	-	-	1	-	-	-	-	-	-	
195253	Seat cushion spring-front right .....	-	-	-	-	1	-	-	-	-	
195252	Seat cushion spring-front left .....	-	-	-	-	1	-	-	-	-	
195251	Seat cushion spring-front left .....	1	1	-	1	-	1	-	-	-	
195254	Seat cushion spring-front left .....	-	-	-	-	-	-	1	-	-	
195250	Seat cushion spring-front right .....	1	1	-	1	-	1	-	-	-	
195256	Seat cushion spring-front right .....	-	-	-	-	-	-	1	-	-	
204221	Seat cushion spring-rear (with angle set axle) .....	1	-	-	-	-	-	-	-	-	
187522	Seat cushion spring-rear .....	-	1	1	-	-	-	-	-	-	
185918	Seat cushion spring-rear (with standard rear axle) .....	1	-	-	-	-	-	-	-	-	
193374	Seat cushion spring-rear .....	-	-	-	-	1	-	-	-	-	
195255	Seat cushion spring-rear (with standard rear axle) .....	-	-	-	1	-	-	-	-	-	
204234	Seat cushion spring-rear (with angle set axle) .....	-	-	-	1	-	-	-	-	-	
172294	Seat cushion spring-folding seat .....	-	2	2	-	-	-	-	-	-	
193068	Seat cushion spring-rumble seat (with standard rear axle) .....	-	-	-	-	-	1	1	-	-	
204264	Seat cushion spring-rumble seat (with angle set axle) .....	-	-	-	-	-	1	1	-	-	

SMOKING CASE

187577	Ash receiver-cowl rail finishing moulding ....	1	1	1	1	1	1	1	1	1
193897	Smoking case ash receiver-right .....	2	-	-	-	-	-	-	-	-
199896	Smoking case ash receiver-left .....	2	-	-	-	-	-	-	-	-
199910	Smoking case ash receiver-right front .....	-	1	1	-	1	-	-	-	-
199909	Smoking case ash receiver-right rear .....	-	1	1	-	1	-	-	-	-
199909	Smoking case ash receiver-left front .....	-	1	1	-	1	-	-	-	-
199910	Smoking case ash receiver-left rear .....	-	1	1	-	1	-	-	-	-
199911	Smoking case ash receiver-right .....	-	-	-	1	-	-	-	-	-
199912	Smoking case ash receiver-left .....	-	-	-	1	-	-	-	-	-
199923	Smoking case cigar lighter .....	2	2	2	2	2	-	-	-	-
182377	Smoking case cigar lighter tip .....	2	2	2	2	2	-	-	-	-
199921	Smoking case clock .....	-	1	1	-	1	-	-	-	-

Piece No	Name	No. Required									
		573	574	575	576	577	578	579	583	587	
193979	Smoking case clock retainer .....	-	1	1	-	1	-	-	-	-	-
199898	Smoking case complete .....	2	-	-	-	-	-	-	-	1	2

## TOGGLE GRIP

199893	Toggle grip .....	2	-	2	2	-	-	-	-	-	-
--------	-------------------	---	---	---	---	---	---	---	---	---	---

## TONNEAU LIGHT

180645	Tonneau light assembly .....	-	-	-	-	-	-	-	-	2	-
102590	Tonneau light bulb 7V. 3 CP. G-6 single contact .....	-	-	-	-	-	-	-	-	-	2
180646	Tonneau light glass and rim .....	-	-	-	-	-	-	-	-	-	2
180647	Tonneau light reflector .....	-	-	-	-	-	-	-	-	-	2
185031	Tonneau light switch .....	-	-	-	-	-	-	-	-	-	2
127502	Tonneau light switch plunger plate .....	-	-	-	-	-	-	-	-	-	2

## TOP

203926	Top assembly .....	-	-	-	-	-	-	-	-	1	-	-
193092	Top center bow .....	-	-	-	-	-	-	-	-	1	-	-
193418	Top envelope assembly .....	-	-	-	-	-	-	-	-	1	-	-
193181	Top folding pillar bumper .....	-	-	-	-	-	-	-	-	2	-	-
193082	Top folding pillar hinge .....	-	-	-	-	-	-	-	-	2	-	-
8234	Screw 1/4-28 x 1-3/4" flat hd. mach. ....	-	-	-	-	-	-	-	-	6	-	-
62065	Washer 1/4" .....	-	-	-	-	-	-	-	-	6	-	-
5502	Lockwasher 1/4" .....	-	-	-	-	-	-	-	-	6	-	-
7004	Nut 1/4"-28 .....	-	-	-	-	-	-	-	-	6	-	-
193148	Top folding pillar hinge bracket-right .....	-	-	-	-	-	-	-	-	1	-	-
193147	Top folding pillar hinge bracket-left .....	-	-	-	-	-	-	-	-	1	-	-
7613	Bolt 1/4-28 x 1-3/4" carriage .....	-	-	-	-	-	-	-	-	8	-	-
5502	Lockwasher 1/4" .....	-	-	-	-	-	-	-	-	8	-	-
7004	Nut 1/4"-28 .....	-	-	-	-	-	-	-	-	8	-	-
193162	Top folding pillar hinge pin .....	-	-	-	-	-	-	-	-	2	-	-
5504	Lockwasher 5/16" .....	-	-	-	-	-	-	-	-	2	-	-
193437	Top to front pillar weatherstrip-right .....	-	-	-	-	-	-	-	-	1	1	1
193438	Top to front pillar weatherstrip-left .....	-	-	-	-	-	-	-	-	1	1	1
193629	Top prop right assembly .....	-	-	-	-	-	-	-	-	1	-	-
193630	Top prop left assembly .....	-	-	-	-	-	-	-	-	1	-	-
193060	Top prop roller .....	-	-	-	-	-	-	-	-	2	-	-
193061	Top prop roller screw .....	-	-	-	-	-	-	-	-	2	-	-
193087	Top rear bow .....	-	-	-	-	-	-	-	-	1	-	-
184505	Top rear bow slat tee nut .....	-	-	-	-	-	-	-	-	2	-	-
193249	Top rear curtain window .....	-	-	-	-	-	-	-	-	1	-	-
195270	Top rear curtain window glass .....	-	-	-	-	-	-	-	-	1	-	-
193056	Top side rail center hinge assembly .....	-	-	-	-	-	-	-	-	2	-	-
193180	Top to windshield clamp assembly .....	-	-	-	-	-	-	-	-	2	2	-
193154	Top to windshield clamp catch .....	-	-	-	-	-	-	-	-	2	2	-
195685	Top to windshield clamp screw .....	-	-	-	-	-	-	-	-	-	4	-
193436	Top to windshield header weatherstrip .....	-	-	-	-	-	-	-	-	1	1	-

## TRUNK AND TRUNK PLATFORM

195797	Trunk assembly-complete .....	-	-	-	-	-	-	-	-	-	-	1
195712	Trunk check bracket .....	-	-	-	-	-	-	-	-	-	-	4
195718	Trunk lid check assembly .....	-	-	-	-	-	-	-	-	-	-	1

Piece No.	Name	No. Required									
		373	374	375	376	377	378	379	383	387	
195719	Trunk lid check assembly .....	-	-	-	-	-	-	-	-	-	1
195758	Trunk lid lock .....	-	-	-	-	-	-	-	-	-	2
187391	Rear platform trunk bar-center .....	-	-	-	3	-	-	-	-	-	-
187394	Rear platform trunk bar-outside right .....	-	-	-	1	-	-	-	-	-	-
187393	Rear platform trunk bar-outside left .....	-	-	-	1	-	-	-	-	-	-

## VENTILATOR

187998	Ventilator cover assembly .....	1	1	1	1	1	1	1	1	1	1
137537	Ventilator cover hinge screw .....	2	2	2	2	2	2	2	2	2	2
3868	Washer 1/4" .....	2	2	2	2	2	2	2	2	2	2
7104	Nut 1/4"-28 castle .....	2	2	2	2	2	2	2	2	2	2
4280	Pin 1/16 x 1/2" cotter .....	2	2	2	2	2	2	2	2	2	2
185776	Ventilator cover operating lever .....	1	1	1	1	1	1	1	1	1	1
7800	Screw 1/4-27 x 1" hex. hd. mach. ....	2	2	2	2	2	2	2	2	2	2
5502	Lockwasher 1/4" .....	2	2	2	2	2	2	2	2	2	2
7004	Nut 1/4"-28 .....	2	2	2	2	2	2	2	2	2	2
3868	Washer 1/4" .....	2	2	2	2	2	2	2	2	2	2
118555	Ventilator cover operating lever pin .....	1	1	1	1	1	1	1	1	1	1
118771	Ventilator cover operating pin roller .....	1	1	1	1	1	1	1	1	1	1
4280	Pin 1/16 x 1/2" cotter .....	1	1	1	1	1	1	1	1	1	1
187192	Ventilator cover operating lever ratchet .....	1	1	1	1	1	1	1	1	1	1
5792	Ventilator cover operating lever ratchet yoke end pin 5/16" .....	1	1	1	1	1	1	1	1	1	1
4290	Pin 3/32 x 5/8" cotter .....	1	1	1	1	1	1	1	1	1	1
138261	Ventilator cover spring .....	1	1	1	1	1	1	1	1	1	1
145383	Ventilator hinge adjusting plate assembly-left	1	1	1	1	1	1	1	1	1	1
145384	Ventilator hinge adjusting plate assembly- right .....	1	1	1	1	1	1	1	1	1	1
187137	Ventilator screen assembly .....	1	1	1	1	1	1	1	1	1	1
185800	Ventilator side door gutter and operating lever bracket assembly-right .....	1	1	1	1	1	1	1	1	1	1
185799	Ventilator side door gutter and operating lever bracket assembly left .....	1	1	1	1	1	1	1	1	1	1
185798	Ventilator side door and hinge assembly-right.	1	1	1	1	1	1	1	1	1	1
185797	Ventilator side door and hinge assembly-left .	1	1	1	1	1	1	1	1	1	1
185893	Ventilator side door hinge bumper .....	2	2	2	2	2	2	2	2	2	2
185809	Ventilator side door hinge pin .....	2	2	2	2	2	2	2	2	2	2
4690	Pin spring cotter 1/16 x 3/8" .....	2	2	2	2	2	2	2	2	2	2
199192	Ventilator side door operating lever sleeve ..	2	2	2	2	2	2	2	2	2	2
5667	Ventilator side door operating lever screw No. 10-32 x 5/8" rnd. hd. ....	2	2	2	2	2	2	2	2	2	2
5500	Lockwasher No. 10 .....	2	2	2	2	2	2	2	2	2	2
7003	Nut No. 10-32 .....	2	2	2	2	2	2	2	2	2	2
199170	Ventilator side door operating lever handle ..	2	2	2	2	2	2	2	2	2	2
5954	Ventilator side door operating lever handle screw .....	4	4	4	4	4	4	4	4	4	4
199360	Ventilator side door operating lever plunger .	2	2	2	2	2	2	2	2	2	2
5346	Screw No. 10-32 x 7/8" rnd. hd. mach. ....	2	2	2	2	2	2	2	2	2	2
5500	Lockwasher 3/16" .....	2	2	2	2	2	2	2	2	2	2
7003	Nut No. 10-32 plain .....	2	2	2	2	2	2	2	2	2	2
185808	Ventilator side door operating spring .....	2	2	2	2	2	2	2	2	2	2
199356	Ventilator side screen assembly .....	2	2	2	2	2	2	2	2	2	2
185814	Ventilator side weatherstrip .....	2	2	2	2	2	2	2	2	2	2
187126	Ventilator weatherstrip retainer assembly ....	1	1	1	1	1	1	1	1	1	1
185938	Ventilator weatherstrip .....	1	1	1	1	1	1	1	1	1	1

Piece No.	Name	No. Required								
		575	574	575	576	577	578	579	583	587
<b>VISOR</b>										
179077	Sun visor hinge .....	2	2	2	2	2	2	-	-	-
179081	Sun visor panel trimmed assembly-right .....	1	1	1	1	1	1	-	-	-
179082	Sun visor panel trimmed assembly-left .....	1	1	1	1	1	1	-	-	-
<b>WINDOW</b>										
178949	Window anti-rattler .....	4	4	4	4	2	2	-	-	-
187982	Window anti-rattler .....	-	-	-	-	-	-	4	8	4
178928	Window anti-rattler partition-rear .....	-	-	1	-	-	-	-	-	-
180693	Window anti-rattler partition-front .....	-	-	1	-	-	-	-	-	-
185304	Window curtain rear assembly .....	1	1	1	1	1	1	-	-	-
185305	Window curtain side assembly .....	2	-	-	-	-	-	-	-	-
185306	Window curtain side assembly .....	-	2	2	-	-	-	-	-	-
185308	Window curtain side assembly .....	-	-	-	-	2	-	-	-	-
29790	Window curtain guide cord .....	x	x	x	x	x	x	-	-	-
185276	Window curtain roller rear assembly .....	1	1	1	1	1	1	-	-	-
185278	Window curtain roller side assembly .....	2	-	-	-	-	-	-	-	-
185279	Window curtain roller side assembly .....	-	-	-	-	2	-	-	-	-
185280	Window curtain roller side assembly .....	-	2	2	-	2	-	-	-	-
182434	Window curtain stick .....	3	3	3	1	3	1	-	-	-
173514	Window curtain tassel .....	3	3	3	1	3	1	-	-	-
193046	Window frame door glass channel assembly-right .....	-	-	-	-	-	1	-	-	-
193047	Window frame door glass channel assembly-left .....	-	-	-	-	-	1	-	-	-
196034	Window glass-anti-rattler-door front .....	-	-	-	-	-	-	2	-	-
196035	Window glass-anti-rattler-retainer-door front .....	-	-	-	-	-	-	2	-	-
195717	Window glass bumper-door .....	-	-	-	-	-	-	-	8	4
143554	Window glass cushion .....	x	x	x	x	x	x	-	-	-
195492	Window glass cushion .....	-	-	-	-	-	-	x	-	-
185346	Window glass cushion-rear .....	1	1	1	1	1	-	-	-	-
187965	Window glass-door .....	-	-	-	-	-	-	2	-	-
193022	Window glass-door .....	-	-	-	-	-	2	-	-	-
185582	Window glass-door-front .....	2	2	2	2	2	-	-	-	-
185576	Window glass-door-front .....	-	2	2	-	-	-	-	-	-
185336	Window glass-door-rear .....	2	2	2	2	-	-	-	-	-
185570	Window glass-door-rear .....	-	2	2	-	-	-	-	-	-
181537	Window glass-partition .....	-	-	1	-	-	-	-	-	-
185347	Window glass-rear .....	1	1	1	1	1	-	-	-	-
172284	Window glass-rear .....	-	-	-	-	-	1	-	-	-
185577	Window glass-side .....	2	-	-	-	-	-	-	-	-
185578	Window glass-side .....	-	2	2	-	-	-	-	-	-
187840	Window glass-side .....	-	-	-	-	2	-	-	-	-
51331	Window glass packing .....	x	x	x	x	x	x	x	-	-
162217	Window glass partition bumper .....	-	-	2	-	-	-	-	-	-
193044	Window lifter assembly-door-right .....	-	-	-	-	-	-	1	-	-
193045	Window lifter assembly-door-left .....	-	-	-	-	-	-	1	-	-
178927	Window lifter bumper .....	x	x	x	x	x	x	x	x	x
185587	Window lifter-door-front right assembly .....	1	1	1	1	1	1	-	-	-
185595	Window lifter-door-front right assembly .....	-	1	1	-	-	-	-	-	-
185588	Window lifter-door-front left assembly .....	1	1	1	1	1	1	-	-	-
185594	Window lifter-door-front left assembly .....	-	1	1	-	-	-	-	-	-
183850	Window lifter-door-rear right assembly .....	1	1	1	1	-	-	-	-	-
184052	Window lifter-door-rear right assembly .....	-	1	1	-	-	-	-	-	-
183851	Window lifter-door-rear left assembly .....	1	1	1	1	-	-	-	-	-
184053	Window lifter door-rear left assembly .....	-	1	1	-	-	-	-	-	-
181759	Window lifter partition assembly .....	-	-	1	-	-	-	-	-	-
173415	Window lifter rear assembly .....	-	-	-	-	-	1	-	-	-
187978	Window lifter regulator roller guide-front right .....	-	-	-	-	-	-	1	1	1

Piece No.	Name	No. Required								
		573	574	575	576	577	578	579	583	587
187977	Window lifter regulator roller guide-front left .....	-	-	-	-	-	-	1	1	1
183258	Window lifter regulator roller guide-rear left .....	-	-	-	-	-	-	1	3	1
183257	Window lifter regulator roller guide-rear right .....	-	-	-	-	-	-	1	3	1
185590	Window lifter-side right assembly .....	1	-	-	-	-	-	-	-	-
185593	Window lifter-side right assembly .....	-	1	1	-	-	-	-	-	-
187879	Window lifter-side right assembly .....	-	-	-	-	1	-	-	-	-
185589	Window lifter-side left assembly .....	1	-	-	-	-	-	-	-	-
185592	Window lifter-side left assembly .....	-	1	1	-	-	-	-	-	-
187878	Window lifter-side left assembly .....	-	-	-	-	1	-	-	-	-
187225	Window regulator-door-front right .....	1	1	1	1	1	1	-	-	-
195788	Window regulator-door-front right .....	-	-	-	-	-	-	-	1	1
183173	Window regulator-door-left .....	-	-	-	-	-	-	1	-	-
183172	Window regulator-door-right .....	-	-	-	-	-	-	1	-	-
195789	Window regulator-door-front left .....	-	-	-	-	-	-	-	1	1
187226	Window regulator-door-front left .....	1	1	1	1	1	1	-	-	-
195790	Window regulator-door-rear right .....	-	-	-	-	-	-	-	1	-
187227	Window regulator-door-rear right .....	1	1	1	1	-	-	-	-	-
195791	Window regulator-door-rear left .....	-	-	-	-	-	-	-	1	-
187228	Window regulator-door-rear left .....	1	1	1	1	-	-	-	-	-
199922	Window regulator handle-long .....	4	4	4	4	2	2	2	4	2
199907	Window regulator handle-short .....	2	2	3	-	-	-	-	-	-
199908	Window regulator handle-short .....	-	-	-	-	2	-	-	-	-
199915	Window regulator handle-long .....	-	-	-	-	-	1	-	-	-
180152	Window regulator handle escutcheon plate .....	4	4	4	4	2	2	2	4	2
199903	Window regulator handle escutcheon plate .....	-	-	1	-	-	-	-	-	-
180300	Window regulator handle escutcheon plate .....	-	-	-	-	2	-	-	-	-
199902	Window regulator handle escutcheon plate .....	2	2	2	-	-	-	-	-	-
173537	Window regulator handle escutcheon plate .....	-	-	-	-	-	1	-	-	-
133264	Window regulator handle escutcheon plate spring .....	4	6	7	4	4	3	2	4	2
133264	Window regulator handle escutcheon plate spring .....	6	4	4	-	-	-	-	-	-
180153	Window regulator handle pin .....	4	4	4	4	4	2	2	4	2
132972	Window regulator handle pin .....	-	-	-	-	-	1	-	-	-
180295	Window regulator handle screw No. 10-32 x 17/32" cup point headless set .....	2	2	3	-	-	-	-	-	-
184057	Window regulator-partition .....	-	-	1	-	-	-	-	-	-
183882	Window regulator-rear .....	-	-	-	-	-	1	-	-	-
187836	Window regulator-side right .....	-	-	-	-	1	-	-	-	-
184049	Window regulator-side right .....	-	1	1	-	-	-	-	-	-
184048	Window regulator-side right .....	1	-	-	-	-	-	-	-	-
184049	Window regulator-side left .....	1	-	-	-	-	-	-	-	-
184048	Window regulator-side left .....	-	1	1	-	-	-	-	-	-
187835	Window regulator-side left .....	-	-	-	-	1	-	-	-	-

WINDSHIELD

185714	Windshield assembly .....	1	1	1	1	1	1	-	-	-
187844	Windshield assembly .....	-	-	-	-	-	-	1	1	1
5588	Screw No. 8-32 x 7/16" oval hd. mach. ....	4	4	4	4	4	4	4	4	4
5312	Windshield to body screw No. 8-32 x 3/8" oval hd. mach. ....	24	24	24	24	24	24	-	24	24
5586	Windshield to body screw No. 8-32 x 5/16" flat hd. mach. ....	-	-	-	-	-	-	24	-	-
194871	Windshield cable-short (1-23/32" long) .....	1	1	1	1	1	1	-	-	-
194872	Windshield cable-intermediate (3-9/32" long) .	1	1	1	1	1	1	-	-	-

Piece No.	Name	No. Required								
		573	574	575	576	577	578	579	583	587
194873	Windshield cable-long (38 1/8" long) .....	1	1	1	1	1	1	-	-	-
194874	Windshield cable adjusting nut-L.H. thread....	1	1	1	1	1	1	-	-	-
194875	Windshield cable adjusting nut-R.H. thread ...	1	1	1	1	1	1	-	-	-
194876	Windshield cable adjusting screw .....	1	1	1	1	1	1	-	-	-
194877	Windshield cable lever assembly .....	1	1	1	1	1	1	-	-	-
193107	Windshield clamp ferrule-right .....	-	-	-	-	-	-	1	1	1
193106	Windshield clamp ferrule-left .....	-	-	-	-	-	-	1	1	1
185765	Windshield clamp ferrule-right .....	1	1	1	1	1	1	-	-	-
187689	Windshield clamp ferrule-left .....	1	1	1	1	1	1	-	-	-
187674	Windshield clamp striker plate assembly .....	2	2	2	2	2	2	-	-	-
187681	Windshield clamp striker plate bracket .....	2	2	2	2	2	2	-	-	-
187675	Windshield cleaner to dash connecting tube assembly .....	1	1	1	1	1	1	-	-	-
193382	Windshield cleaner to dash connector tube asb.	-	-	-	-	-	-	1	1	1
177851	Windshield cleaner to dash connecting tube flared tube connection adapter .....	1	1	1	1	1	1	2	2	2
1574777	Windshield cleaner to dash connecting tube union tube nut .....	1	1	1	1	1	1	2	2	2
177840	Windshield cleaner to dash connecting tube clip-single .....	1	1	1	1	1	1	-	-	-
140009	Windshield cleaner hose .....	-	-	-	-	-	-	2	2	2
185141	Windshield cleaner hose 7" long .....	1	1	1	1	1	1	-	-	-
193439	Windshield cleaner hose 4-1/2" long .....	1	1	1	1	1	1	-	-	-
185947	Windshield cleaner hose .....	2	2	2	2	2	2	-	-	-
141305	Windshield cleaner hose 6-3/4" long .....	-	-	-	-	-	-	2	2	2
140009	Windshield cleaner hose 4-3/4" long .....	-	-	-	-	-	-	4	4	4
193380	Windshield cleaner intermediate tube asb.- right .....	-	-	-	-	-	-	1	1	1
193381	Windshield cleaner intermediate tube asb.-left	-	-	-	-	-	-	1	1	1
157688	Windshield cleaner intermediate tube flanged tube connection adapter .....	-	-	-	-	-	-	2	2	2
183463	Windshield cleaner intermediate tube union nut	-	-	-	-	-	-	2	2	2
193379	Windshield cleaner intermediate tube connecti connection .....	-	-	-	-	-	-	1	1	1
177840	Windshield cleaner intermediate tube clip- single .....	-	-	-	-	-	-	2	2	2
193388	Windshield cleaner motor complete-left .....	-	-	-	-	-	-	1	1	1
193389	Windshield cleaner motor complete-right .....	-	-	-	-	-	-	1	1	1
185924	Windshield cleaner motor-right .....	1	1	1	1	1	1	-	-	-
185925	Windshield cleaner motor-left .....	1	1	1	1	1	1	-	-	-
187000	Windshield cleaner motor operating lever knob.	2	2	2	2	2	2	-	-	-
193764	Windshield cleaner motor operating lever ferrule .....	2	2	2	2	2	2	-	-	-
193391	Windshield cleaner motor attaching screw .....	-	-	-	-	-	-	4	4	4
187635	Windshield cleaner motor shaft washer .....	2	2	2	2	2	2	-	-	-
179708	Windshield cleaner motor shaft washer .....	-	-	-	-	-	-	2	2	2
193390	Windshield cleaner motor spacer .....	-	-	-	-	-	-	4	4	4
7911	Windshield cleaner motor support bracket screw No. 10-32 x 3/8" rnd. hd. ....	4	4	4	4	4	4	-	-	-
5500	Lockwasher No. 10 .....	4	4	4	4	4	4	-	-	-
193301	Windshield cleaner pillar tube clip .....	-	-	-	-	-	-	4	4	4
185934	Windshield cleaner pillar tube coupling nut ..	1	1	1	1	1	1	-	-	-
185935	Windshield cleaner pillar tube elbow .....	1	1	1	1	1	1	-	-	-
185936	Windshield cleaner pillar tube tee connecting.	1	1	1	1	1	1	-	-	-
193407	Windshield cleaner wiper .....	-	-	-	-	-	-	2	2	2
195378	Windshield cleaner wiper .....	2	2	2	2	2	2	-	-	-
193406	Windshield cleaner wiper arm .....	-	-	-	-	-	-	2	2	2
195391	Windshield cleaner wiper arm .....	2	2	2	2	2	2	-	-	-
187011	Windshield cleaner wiper arm spring .....	2	2	2	2	2	2	-	-	-
193269	Windshield cowl weatherstrip .....	-	-	-	-	-	-	1	1	1

Piece No.	Name	No. Required								
		574	574	575	576	577	578	579	583	587
185770	Windshield cowl weatherstrip .....	1	1	1	1	1	1	-	-	-
5475	Screw No. 4-40 x 5/16" flat hd. ....	-	-	-	-	-	-	2	2	2
33170	Ferrule No. 4 .....	2	2	2	2	2	2	-	-	-
194867	Windshield finger pull assembly-right .....	1	1	1	1	1	1	-	-	-
194982	Windshield finger pull assembly-left .....	-	-	-	-	-	-	1	1	1
194983	Windshield finger pull assembly-right .....	-	-	-	-	-	-	1	1	1
194866	Windshield finger pull and cable lever asb. ..	1	1	1	1	1	1	-	-	-
194984	Windshield finger pull bracket .....	-	-	-	-	-	-	1	1	1
194868	Windshield finger pull cap nut .....	2	2	2	2	2	2	2	2	2
194869	Windshield finger pull cap nut spring .....	2	2	2	2	2	2	2	2	2
194859	Windshield frame and glass assembly .....	1	1	1	1	1	1	-	-	-
194939	Windshield frame and glass assembly .....	-	-	-	-	-	-	1	1	1
185916	Windshield glass .....	1	1	1	1	1	1	-	-	-
193209	Windshield glass .....	-	-	-	-	-	-	1	1	1
194870	Windshield hinge weather block .....	1	1	1	1	1	1	-	-	-
194985	Windshield hinge weather block .....	-	-	-	-	-	-	1	1	1
193689	Windshield hinge weatherstrip .....	-	-	-	-	-	-	1	1	1
193675	Windshield hinge weatherstrip .....	1	1	1	1	1	1	-	-	-
194861	Windshield locking mechanism-right .....	1	1	1	1	1	1	-	-	-
194981	Windshield locking mechanism-right .....	-	-	-	-	-	-	1	1	1
194860	Windshield locking mechanism-left .....	1	1	1	1	1	1	-	-	-
194980	Windshield locking mechanism-left .....	-	-	-	-	-	-	1	1	1
194864	Windshield locking mechanism lower screw .....	2	2	2	2	2	2	2	2	2
194865	Windshield locking mechanism upper screw .....	2	2	2	2	2	2	2	2	2
194987	Windshield locking mechanism link-right .....	-	-	-	-	-	-	1	1	1
194988	Windshield locking mechanism link-left .....	-	-	-	-	-	-	1	1	1
194878	Windshield right hand mechanism locking cap screw .....	1	1	1	1	1	1	1	1	1
194879	Windshield right hand mechanism locking screw spring washer .....	1	1	1	1	1	1	-	-	-
194986	Windshield right hand mechanism lock cap screw washer .....	-	-	-	-	-	-	1	1	1
185831	Windshield sash glass retainer weatherstrip ..	1	1	1	1	1	1	-	-	-
123123	Windshield sash glass retainer weatherstrip (Bulk) (12" long) .....	-	-	-	-	-	-	2	2	2

TRIMMING MATERIAL

195672	Binding carpet .....	x	x	x	x	x	x	-	-	-
139910	Binding cloth wire-on .....	x	x	x	x	x	x	-	-	-
167438	Binding cloth wire-on (cordless) (1/2" wide) .	-	-	x	-	-	-	-	-	-
192035	Binding cloth wire-on (leather cord skiver grain) .....	x	x	-	x	-	x	-	-	-
156689	Binding (1-1/8") leather colonial grain .....	-	-	x	-	-	-	x	-	-
164370	Binding (1-1/8") leather skiver grain .....	x	x	x	x	x	x	-	-	-
156691	Binding (1-1/8") leather imitation colonial grain .....	-	-	-	-	-	x	x	-	-
192294	Binding (1-1/2") leather colonial grain .....	-	-	x	-	-	-	x	-	-
192295	Binding (2-1/4") leather colonial grain .....	-	-	x	-	-	-	x	-	-
192037	Binding (1-1/2") leather skiver grain .....	x	x	x	x	x	x	-	-	-
192038	Binding (2-1/4") leather skiver grain .....	x	x	x	x	x	x	-	-	-
176578	Binding leather wire-on colonial grain .....	-	-	x	-	-	x	x	-	-
192088	Binding imitation leather wire-on colonial grain .....	x	x	x	x	x	x	x	-	-
176579	Binding leather wire-on (cordless) .....	-	-	x	-	-	-	-	-	-
29595	Burlap 10 oz.-40" wide .....	x	x	x	x	x	-	-	-	-
195669	Carpet-woolen 45" wide .....	x	x	x	x	x	x	x	-	-
166931	Carpet-hair 36" wide .....	-	-	-	-	x	x	x	-	-
29851	Cloth-cotton 36" wide .....	x	x	x	x	x	x	-	-	-
185467	Cord 5/64" manila .....	x	x	x	x	x	x	-	-	-



Piece No.	Name	No. Required								
		573	574	575	576	577	578	579	583	587
29612	Cord 1/8" twisted paper .....	X	X	X	X	X	X	X	-	-
182894	Cord 1/4" twisted paper .....	X	X	X	X	X	X	X	-	-
197401	Cord welt-enameled drill .....	X	X	X	X	X	X	X	-	-
113822	Cord welt-enameled drill .....	X	-	-	X	-	X	X	-	-
159187	Cord welt-(3/4 x 1/4") colonial leather .....	-	-	X	-	-	X	X	-	-
182627	Cord welt-leather colonial grain (21/32 x 5/32") .....	-	-	X	-	-	-	X	-	-
156696	Cord welt (11/16 x 3/16") leather colonial grain .....	-	-	X	-	-	-	X	-	-
164373	Cord welt-leather (11/16 x 3/16") skiver grain	X	X	X	X	X	X	-	-	-
182628	Cord welt seaming lace (3/8 x 3/4") .....	-	-	-	X	-	-	-	-	-
173243	Cord welt seaming lace (11/16 x 3/16") .....	X	X	X	X	X	X	-	-	-
161787	Drill-white cotton 7 oz.-36" wide .....	X	X	X	X	X	X	X	-	-
105025	Drill-enameled (50" wide-long grain) .....	X	X	X	X	X	X	X	-	-
185211	Fabric (58" upholstery) .....	X	X	X	X	X	X	-	-	-
195226	Fabric-top material (54" wide) Burbank 1220 drab .....	-	-	-	-	-	-	X	-	-
196391	Fabric-top material (54" wide) Burbank 1221 drab .....	-	-	-	-	-	-	X	-	-
174513	Fabric (54") filled mole skin .....	X	X	X	X	X	X	X	-	-
156541	Fabric-roof covering (Duratex) two ply aqua-proof quantity grain deck A (45" wide) .....	X	X	X	X	X	X	-	-	-
195227	Fabric-side curtain Burbank 1220 drab .....	-	-	-	-	-	-	X	-	-
170310	Gimp (1/2") leather colonial grain .....	-	-	X	-	-	-	X	-	-
156692	Gimp (1/2") imitation black colonial leather .	X	X	X	X	X	X	X	-	-
175234	Gimp (3/4") leather colonial grain .....	-	-	-	-	-	-	X	-	-
192218	Gimp (1/2") leather skiver grain .....	X	X	-	X	X	X	-	-	-
163172	Kersey felt (45" wide) .....	X	X	X	X	X	-	-	-	-
159984	Leather-imitation black patent leather finish.	X	X	X	X	X	X	X	-	-
123507	Leather-imitation (Textileather Co. No. 95153 color .090 or its equivalent) .....	-	-	-	-	-	X	X	-	-
156346	Leather-imitation colonial grain .....	X	X	X	X	X	X	X	-	-
156348	Leather trimming colonial grain .....	-	-	X	-	-	X	X	-	-
161778	Leather binding (skiver grain) .....	X	X	X	X	X	X	-	-	-
192303	Muslin rubber (54" wide) .....	X	X	X	X	X	X	X	-	-
140935	Paper board (1/2 x 48") .....	X	X	X	X	X	X	X	-	-
135117	Paper board shim (1/16 x 1 x 36") .....	X	X	X	X	X	X	X	-	-
167422	Rubber riser (7/16" half rnd.) .....	X	X	X	X	X	X	X	-	-
187444	Rubber riser .....	X	X	X	X	X	X	X	-	-
115023	Rubber riser (3/8" half oval) .....	X	-	X	X	-	-	-	-	-
113983	Silk curtain (22" wide) .....	X	X	X	X	X	X	X	-	-
23652	Tacks-japanned lace 2 oz. .....	X	X	X	X	X	X	X	-	-
106964	Tacks-gimp 3 oz.-japanned .....	X	X	X	X	X	X	X	-	-
113612	Tacks-gimp 4 oz.-japanned .....	X	X	X	X	X	X	X	-	-
29657	Tacks-japanned lace 4 oz. .....	X	X	X	X	X	X	X	-	-
128467	Tacks-japanned lace 8 oz. .....	-	-	-	-	-	X	X	-	-
178961	Tacks-japanned lace 10 oz. .....	-	-	-	-	X	-	-	-	-
29662	Tacks-trimmers 1-1/2 oz.-japanned .....	X	X	X	X	X	X	X	-	-
29663	Tacks-trimmers 2-1/2 oz.-japanned .....	X	X	X	X	X	X	X	-	-
29664	Tacks-trimmers 4 oz.-japanned .....	X	X	X	X	X	X	X	-	-
29666	Tacks-trimmers 10 oz.-japanned .....	X	X	X	X	X	X	X	-	-
113789	Tacks-gimp 6 oz.-japanned .....	X	X	X	X	X	X	X	-	-
29637	Thread-No. EE spool silk .....	X	X	X	X	X	X	X	-	-
192345	Thread-No. 18 linen .....	X	X	X	X	X	X	X	-	-
192346	Thread-No. 25 linen .....	X	X	X	X	X	X	X	-	-
29638	Thread-"A" spool silk .....	X	X	X	X	X	X	X	-	-
156681	Thread-"D" spool silk .....	X	X	X	X	X	X	X	-	-
29640	Thread-"EE" No. 18 or Dean and Sherk No. 12-4.	X	X	X	X	X	X	X	-	-
127808	Thread-Dean and Sherk No. 20-A silk finish ...	X	X	X	X	X	X	X	-	-
167433	Thread-3-36 silk finish cotton .....	X	X	X	X	X	X	X	-	-
167434	Thread-3-60 silk finish cotton .....	X	X	X	X	X	X	X	-	-

SERVICE PARTS LIST—PACKARD TWELVE

Trimming 277

Piece No.	Name	No. Required								
		573	574	575	576	577	578	579	583	587
157022	Thread-Lincoln No. 8 .....	X	X	X	X	X	X	X	-	-
157586	Thread-No. 1201 cord .....	X	X	X	X	X	X	X	-	-
29625	Twine-No. 252 Yazoo .....	X	X	X	X	X	X	X	-	-
192208	Wadding-3" white cotton rolled (3-1/2 oz.) ...	X	X	X	X	X	X	X	-	-
29627	Wadding-33" blue sheet No. 532 .....	X	X	X	X	X	X	X	-	-
182687	Wadding-32" white unbleached No. 532 .....	X	X	X	X	X	X	X	-	-
192209	Wadding-5" white cotton rolled 6 oz. ....	X	X	X	X	X	X	X	-	-
128040	Wadding-33" white sheet .....	X	X	X	X	X	X	X	-	-
183741	Wadding-roof (41" wide) .....	X	X	X	X	X	X	-	-	-
192210	Wadding-7" white cotton rolled (8-1/2 oz.) ...	X	X	X	X	X	X	-	-	-
139457	Wadding-white cotton unbleached rolled 7 oz. .	-	-	-	-	-	X	X	-	-
193352	Webbing-2" wide elastic .....	X	X	-	X	-	X	X	-	-
62759	Webbing-3" wide jute .....	-	X	X	-	-	-	X	-	-
172470	Wadding-4" white cotton unbleached rolled 5 oz. ....	X	X	-	X	-	X	X	-	-
192090	Windlace-cloth .....	X	X	X	X	X	X	-	-	-
185488	Windlace-cloth .....	-	-	X	-	-	-	X	-	-

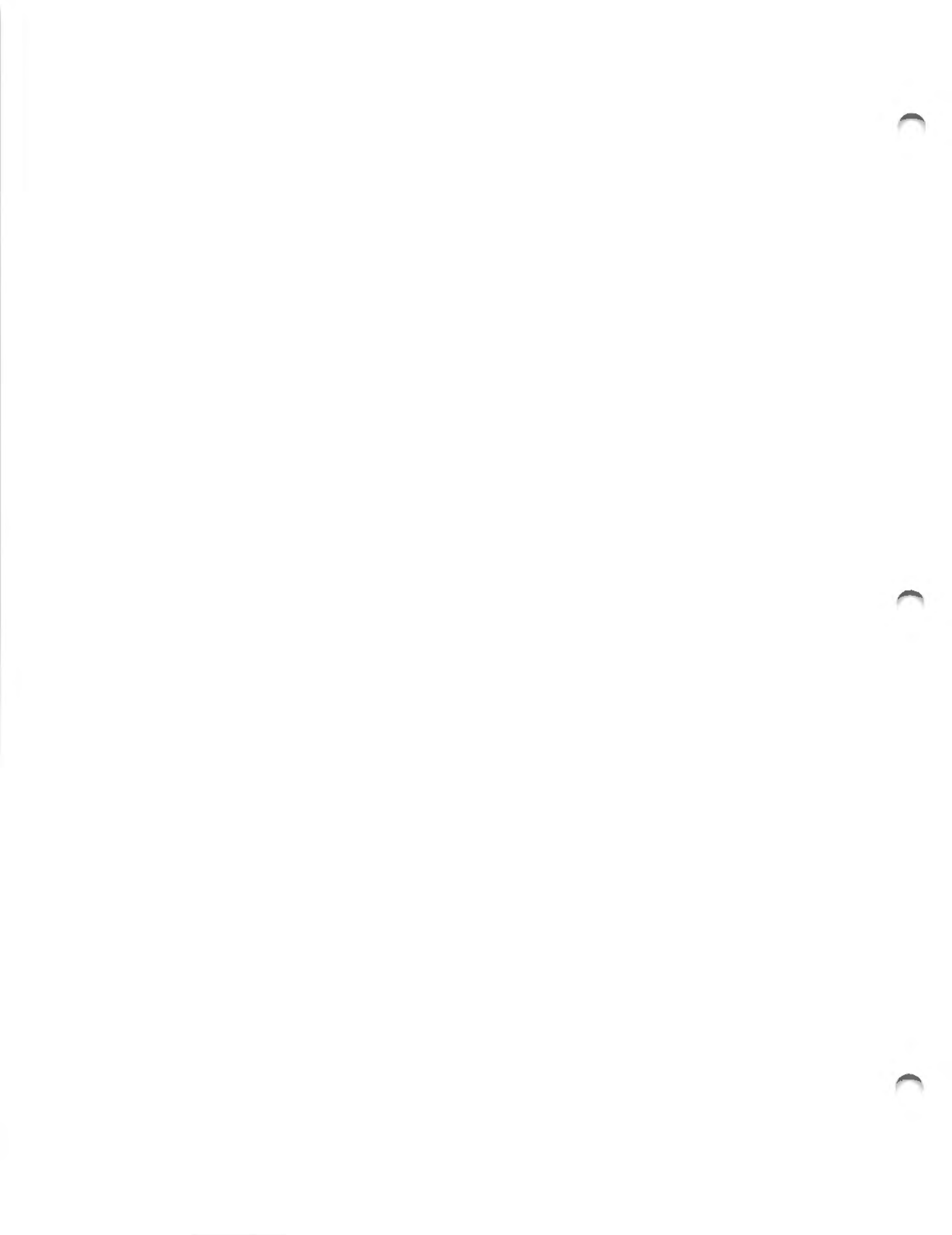

Piece No.	Name	No. Required										
		5633	5633A	633	634	635	636	637	638	639	643	647
<b>BODY ATTACHING PARTS</b>												
199771	Body to frame bolt No. 1 carriage bolt 7/16-20 x 3-5/8" skew head .....	2	2	2	2	2	2	2	2	2	2	2
5282	Body to frame bolt No. 2 - screw 7/16-20 x 3-1/2" hex. hd. mach. ....	2	2	2	2	2	2	2	2	2	2	2
7954	Body to frame bolt No. 3 screw 7/16-20 x 3-1/4" flat hd. mach. ....	-	-	-	-	-	-	2	-	-	-	-
5282	Body to frame bolt No. 3 screw 7/16-20 x 3-1/2" hex. hd. ....	-	-	-	-	-	-	-	-	-	-	2
5281	Body to frame bolt No. 3 screw 7/16-20 x 3-7/8" hex. hd. mach. ....	2	2	2	2	2	2	-	2	2	2	-
6283	Body to frame bolt No. 4 screw 7/16-20 x 3-11/16" flat hd. mach. ..	x	x	x	x	x	-	-	-	-	x	-
5968	Body to frame bolt No. 4 screw 7/16-20 x 4" flat hd. ....	x	x	x	x	x	-	-	-	-	x	-
7954	Body to frame bolt No. 4 screw 7/16-20 x 3-1/4" hex. hd. mach. ....	-	-	-	-	-	-	-	2	2	-	-
5281	Body to frame bolt No. 4 screw 7/16-20 x 3-7/8" hex. hd. mach. ....	-	-	-	-	-	2	2	-	-	-	-
5282	Body to frame bolt No. 4 screw 7/16-20 x 3-1/2" hex. hd. ....	-	-	-	-	-	-	-	-	-	-	2
5671	Body to frame bolt No. 5 screw 7/16-20 x 5-3/8" hex. hd. mach. ....	2	2	2	2	2	-	2	2	2	2	-
187285	Body to frame bolt No. 5 carriage bolt 7/16-20 x 7-3/16" skew head ...	-	-	-	-	-	2	-	-	-	-	2
199770	Body to frame bolt plate .....	2	2	2	2	2	2	2	2	2	2	2
182439	Body to frame bolt nut lock .....	4	4	4	4	4	2	2	2	2	4	-
182439	Body to frame bolt nut .....	-	-	-	-	-	-	-	-	-	-	4
131809	Body to frame bolt washer-large washer 7/16" plain special .....	2	2	2	2	2	2	4	4	4	2	6
131046	Body to frame bolt washer-small washer 7/16" plain special .....	12	12	12	12	12	10	12	12	12	12	10
5508	Body to frame bolt lockwasher 7/16" std. ....	8	8	8	8	8	8	8	8	8	8	6
5806	Body to frame bolt lockwasher (Shakeproof) .....	2	2	2	2	2	2	2	2	2	2	4
7007	Body to frame bolt nut 7/16-20 plain std. ....	8	8	8	8	8	8	8	8	8	8	10
206192	Body to frame liner 3/16" thick .....	x	x	x	x	x	x	x	x	x	x	x
193883	Body to frame liner 3/16" thick .....	-	-	-	-	-	x	x	x	x	-	x
206193	Body to frame liner 1/4" thick .....	x	x	x	x	x	x	x	x	x	x	x
185271	Body to frame liner 1/4" thick .....	-	-	-	-	-	x	x	x	x	-	x
206194	Body to frame liner 5/16" thick .....	x	x	x	x	x	x	x	x	x	x	x
185272	Body to frame liner 5/16" thick .....	-	-	-	-	-	x	x	x	x	-	x
167924	Body to frame liner hand brake lever insulator .....	1	1	1	1	1	1	1	1	1	1	1
185270	Body hold down bolt bracket liner 3/8" thick .....	x	x	x	x	x	x	x	x	x	x	x
185274	Body hold down bolt bracket liner 1/2" thick .....	x	x	x	x	x	x	x	x	x	x	x
185273	Body hold down bolt bracket liner 3/16" thick .....	x	x	x	x	x	x	x	x	x	x	x
133104	Body hold down bolt bracket liner 1/32" thick .....	x	x	x	x	x	x	x	x	x	x	x
193930	Body to frame liner 3/16" thick .....	-	-	-	x	x	-	-	-	-	-	-
193931	Body to frame liner 3/16" thick .....	x	x	x	-	-	x	x	x	x	x	x

Piece No.	Name	No. Required										
		5633	5633A	633	634	635	636	637	638	639	643	647
<b>ARM REST AND ARM SLING</b>												
Always send samples of material when ordering arm rest trimmed assemblies, as the assemblies are upholstered to match the body interior.												
187542	Arm rest trimmed assembly-right .....	-	-	-	-	-	-	1	-	-	-	-
204612	Arm rest trimmed assembly-right .....	-	-	-	1	1	-	-	-	-	-	-
187536	Arm rest trimmed assembly-right .....	1	1	-	-	-	-	-	-	-	-	-
187530	Arm rest trimmed assembly-right .....	-	-	-	-	-	1	-	-	-	-	-
204616	Arm rest trimmed assembly-right .....	-	-	1	-	-	-	-	-	-	-	-
187537	Arm rest trimmed assembly-left .....	1	1	-	-	-	-	-	-	-	-	-
204617	Arm rest trimmed assembly-left .....	-	-	1	-	-	-	-	-	-	-	-
187543	Arm rest trimmed assembly-left .....	-	-	-	-	-	-	1	-	-	-	-
204613	Arm rest trimmed assembly-left .....	-	-	-	1	1	-	-	-	-	-	-
187531	Arm rest trimmed assembly-left .....	-	-	-	-	-	1	-	-	-	-	-
187877	Arm rest cushion-right .....	-	-	-	-	-	-	1	-	-	-	-
187876	Arm rest cushion-left .....	-	-	-	-	-	-	1	-	-	-	-
204642	Arm rest cushion-right .....	-	-	-	1	1	-	-	-	-	-	-
204643	Arm rest cushion-left .....	-	-	-	1	1	-	-	-	-	-	-
187406	Arm rest cushion-right .....	-	-	-	-	-	1	-	-	-	-	-
187407	Arm rest cushion-left .....	-	-	-	-	-	1	-	-	-	-	-
187314	Arm rest cushion-right .....	1	1	-	-	-	-	-	-	-	-	-
187315	Arm rest cushion-left .....	1	1	-	-	-	-	-	-	-	-	-
204650	Arm rest cushion-right .....	-	-	1	-	-	-	-	-	-	-	-
204651	Arm rest cushion-left .....	-	-	1	-	-	-	-	-	-	-	-
183673	Arm rest end cushion-right .....	1	1	-	-	-	-	-	-	-	-	-
183672	Arm rest end cushion-left .....	1	1	-	-	-	-	-	-	-	-	-
172205	Arm rest vanity case mirror .....	-	-	-	1	1	-	1	-	-	-	-
187596	Arm rest vanity case mirror .....	1	1	1	-	-	-	-	-	-	-	-
172204	Arm rest vanity case memorandum book .	-	-	-	1	1	-	1	-	-	-	-
187594	Arm rest vanity case memorandum book .	1	1	1	-	-	-	-	-	-	-	-
140942	Arm rest vanity case memorandum book pencil .....	-	-	-	1	1	-	1	-	-	-	-
180082	Arm rest vanity case memorandum book pencil .....	1	1	1	-	-	-	-	-	-	-	-
187826	Arm sling .....	-	-	-	2	2	-	-	-	-	-	-
204667	Arm sling rod left assembly .....	-	-	-	1	1	-	-	-	-	-	-
204666	Arm sling rod right assembly .....	-	-	-	1	1	-	-	-	-	-	-
206252	Arm sling rod bracket front right ....	-	-	-	1	1	-	-	-	-	-	-
206253	Arm sling rod bracket front left .....	-	-	-	1	1	-	-	-	-	-	-
206254	Arm sling rod bracket rear right .....	-	-	-	1	1	-	-	-	-	-	-
206255	Arm sling rod bracket rear left .....	-	-	-	1	1	-	-	-	-	-	-

**BODY WIRING (Miscellaneous)**

33287	Body feed cable terminal 13/64" eye ..	1	1	1	1	1	1	1	1	1	1	1
176817	Body feed cable terminal 3/16" eye ...	2	2	-	-	-	-	-	-	-	-	-
36111	Cable terminal insulator .....	1	1	1	1	1	1	1	1	1	1	1
48202	Body ground cable terminal 1/4" eye ..	5	5	5	5	6	5	6	1	1	1	1
5430	Body ground cable terminal screw 1/4-28 x 1/2" hex. hd. ....	2	2	2	2	2	2	2	-	-	-	-
5502	Lockwasher 1/4" std. ....	2	2	2	2	2	2	2	-	-	-	-
7004	Nut 1/4-28 .....	2	2	2	2	2	2	2	-	-	-	-
176078	Body wiring cable clip .....	x	x	x	x	x	x	x	x	x	x	x
206706	Body wiring cable clip .....	4	4	-	4	4	-	-	-	-	-	-
194286	Body wiring cable clip .....	2	2	2	2	2	2	2	2	2	2	2

Piece No.	Name	No. Required										
		5633	5633A	633	634	635	636	637	638	639	643	647
<b>BONNET DASH LINER</b>												
204980	Bonnet dash liner .....	2	2	2	2	2	2	2	2	-	-	-
206652	Bonnet dash liner .....	-	-	-	-	-	-	-	-	2	2	2
187260	Bonnet dash liner hook .....	2	2	2	2	2	2	2	2	2	2	2
3866	Washer 3/16" "N" std. ....	2	2	2	2	2	2	2	2	2	2	2
7002	Nut No. 8-32 .....	2	2	2	2	2	2	2	2	2	2	2

**DICTOGRAPH**

147649	Dictograph receiver .....	-	-	-	-	1	-	-	-	-	-	-
187609	Dictograph transmitter and winder assembly .....	-	-	-	-	1	-	-	-	-	-	-
133004	Dictograph winder .....	-	-	-	-	1	-	-	-	-	-	-
5310	Screw No. 8-32 x 1/4" flat hd. mach. ....	-	-	-	-	2	-	-	-	-	-	-
5695	Lockwasher No. 8 special .....	-	-	-	-	2	-	-	-	-	-	-
206224	Dictograph winder bracket .....	-	-	-	-	1	-	-	-	-	-	-

**DOME LIGHT**

211213	Dome light .....	-	-	1	1	-	1	1	1	-	-	-
211211	Dome light-rear .....	1	1	-	-	1	-	-	-	-	-	-
211213	Dome light-front .....	1	1	-	-	1	-	-	-	-	-	-
102585	Dome light bulb (Mazda No. 81) 6 CP G-6 .....	3	3	1	1	3	1	1	1	-	-	-
193893	Dome light door switch cable assembly.	-	-	-	-	-	-	-	1	-	-	-
193759	Dome light door switch cable assembly.	-	-	-	-	-	-	1	-	-	-	-
187698	Dome light door switch cable assembly.	-	-	1	-	-	1	-	-	-	-	-
212173	Dome light door switch cable assembly.	-	-	-	1	-	-	-	-	-	-	-
187716	Dome light door switch cable assembly.	1	1	-	-	1	-	-	-	-	-	-
185031	Dome light door switch .....	2	2	2	2	2	2	2	2	-	-	-
8016	Screw No. 6-40 x 3/8" oval hd. mach. ....	-	-	-	-	-	-	4	4	-	-	-
211214	Dome light glass and rim .....	2	2	1	1	2	1	1	1	-	-	-
182459	Dome light front to instrument board switch .....	1	1	-	-	1	-	-	-	-	-	-
184796	Dome light rear to instrument board switch .....	1	1	-	-	-	-	-	-	-	-	-
185616	Dome light reflector (Two bulb) .....	1	1	-	-	1	-	-	-	-	-	-
180636	Dome light reflector (One bulb) .....	1	1	1	1	1	1	1	1	-	-	-
183844	Dome light switch (3 point) .....	1	1	1	1	2	1	1	1	-	-	-
171533	Dome light to ground cable assembly ..	-	-	-	-	-	-	1	-	-	-	-
199873	Dome light to ground cable assembly ..	-	-	1	-	-	1	-	-	-	-	-
187705	Dome light to ground cable assembly ..	1	1	-	1	1	-	-	-	-	-	-

**DOORS**

All doors must be adjusted to each respective body. To obtain satisfactory replacement of doors, it is advisable to return the damaged door to be repaired, if possible. If this cannot be done, the customer assumes the responsibility of the new door being a satisfactory fit.

Specify on all orders the upholstery material, color and striping.

Piece No.	Name	No. Required										
		5633	5633A	633	634	635	636	637	638	639	643	647
213692	Door trimmed assembly-right .....	-	-	-	-	-	-	-	-	1	-	-
213695	Door trimmed assembly-right .....	-	-	-	-	-	-	-	1	-	-	-
213719	Door trimmed assembly-left .....	-	-	-	-	-	-	-	1	-	-	-
213722	Door trimmed assembly-left .....	-	-	-	-	-	-	-	-	1	-	-
213725	Door trimmed assembly-front right ....	-	-	1	-	-	1	1	-	-	-	-
213727	Door trimmed assembly-front right ....	-	-	-	1	-	-	-	-	-	-	-
213728	Door trimmed assembly-front right ....	-	-	-	-	1	-	-	-	-	-	-
213732	Door trimmed assembly-front right ....	1	1	-	-	-	-	-	-	-	-	-
213712	Door trimmed assembly-front left .....	-	-	1	-	-	1	1	-	-	-	-
213714	Door trimmed assembly-front left .....	-	-	-	1	-	-	-	-	-	-	-
213715	Door trimmed assembly-front left .....	-	-	-	-	1	-	-	-	-	-	-
213730	Door trimmed assembly-front left .....	1	1	-	-	-	-	-	-	-	-	-
213706	Door trimmed assembly-rear right .....	-	-	-	-	-	1	-	-	-	-	-
213708	Door trimmed assembly-rear right .....	-	-	1	-	-	-	-	-	-	-	-
213716	Door trimmed assembly-rear right .....	-	-	-	1	1	-	-	-	-	-	-
213736	Door trimmed assembly-rear right .....	1	1	-	-	-	-	-	-	-	-	-
213698	Door trimmed assembly-rear left .....	-	-	-	-	-	1	-	-	-	-	-
213702	Door trimmed assembly-rear left .....	-	-	1	-	-	-	-	-	-	-	-
213703	Door trimmed assembly-rear left .....	-	-	-	1	1	-	-	-	-	-	-
213734	Door trimmed assembly-rear left .....	1	1	-	-	-	-	-	-	-	-	-

DOOR ARM REST

Always send samples of material when ordering door arm rest trimmed assemblies, as the assemblies are upholstered to match the body interior.

206614	Door arm rest trimmed assembly-right .	1	1	1	1	-	1	1	1	-	-	-
206616	Door arm rest trimmed assembly-right .	-	-	-	-	1	-	-	-	-	-	-
206615	Door arm rest trimmed assembly-left ..	-	-	-	-	1	-	-	-	-	-	-
206613	Door arm rest trimmed assembly-left ..	1	1	1	1	-	1	1	1	-	-	-
206542	Door arm rest cushion-right .....	1	1	1	1	1	1	1	1	-	-	-
206543	Door arm rest cushion-left .....	1	1	1	1	1	1	1	1	-	-	-

DOOR PARTS

199167	Door anti-rattler .....	-	-	-	-	-	-	-	-	2	-	-
204535	Door anti-rattler front upper .....	2	2	2	2	2	2	2	2	2	-	-
6102	Screw No. 6-40 x 1/2" rnd. hd. ...	2	2	2	2	2	2	2	2	-	-	-
199167	Door anti-rattler front lower .....	2	2	2	2	2	2	2	2	-	-	-
5667	Screw No. 10-32 x 5/8" rnd. hd. ..	2	2	2	2	2	2	2	2	-	-	-
199167	Door anti-rattler rear .....	2	2	2	2	2	2	-	-	-	-	-
185601	Door bumper 1-11/32" .....	x	x	x	x	x	x	x	x	x	8	4
185600	Door bumper 1-13/32" .....	x	x	x	x	x	x	x	x	x	x	x
185602	Door bumper 1-9/32" .....	x	x	x	x	x	x	x	x	x	x	x
164699	Door check strap .....	4	4	4	4	4	4	2	2	2	4	2
164359	Door check strap fastener plate .....	4	4	4	4	4	4	2	2	2	4	2
5253	Screw No. 10-32 x 3/4" rnd. hd. ..	4	4	4	4	4	4	4	4	-	-	-
167250	Door check strap guide .....	2	2	2	2	2	2	-	-	-	2	-
179680	Door check strap stop plate .....	2	2	2	2	2	2	2	2	2	2	2
206906	Door header weatherstrip front .....	-	-	2	-	-	2	2	-	-	-	-
206908	Door header weatherstrip front .....	2	2	-	2	2	-	-	-	-	-	-
206909	Door header weatherstrip rear .....	-	-	2	-	-	2	-	-	-	-	-
206911	Door header weatherstrip rear .....	2	2	-	2	2	-	-	-	-	-	-
184659	Door dove-tail female .....	4	4	4	4	4	4	2	2	2	4	4
119298	Door dove-tail male .....	4	4	4	4	4	4	2	2	2	4	4
204609	Door hinge-front center left .....	-	-	-	-	-	-	-	-	1	1	1
204608	Door hinge-front center right .....	-	-	-	-	-	-	-	-	1	1	1



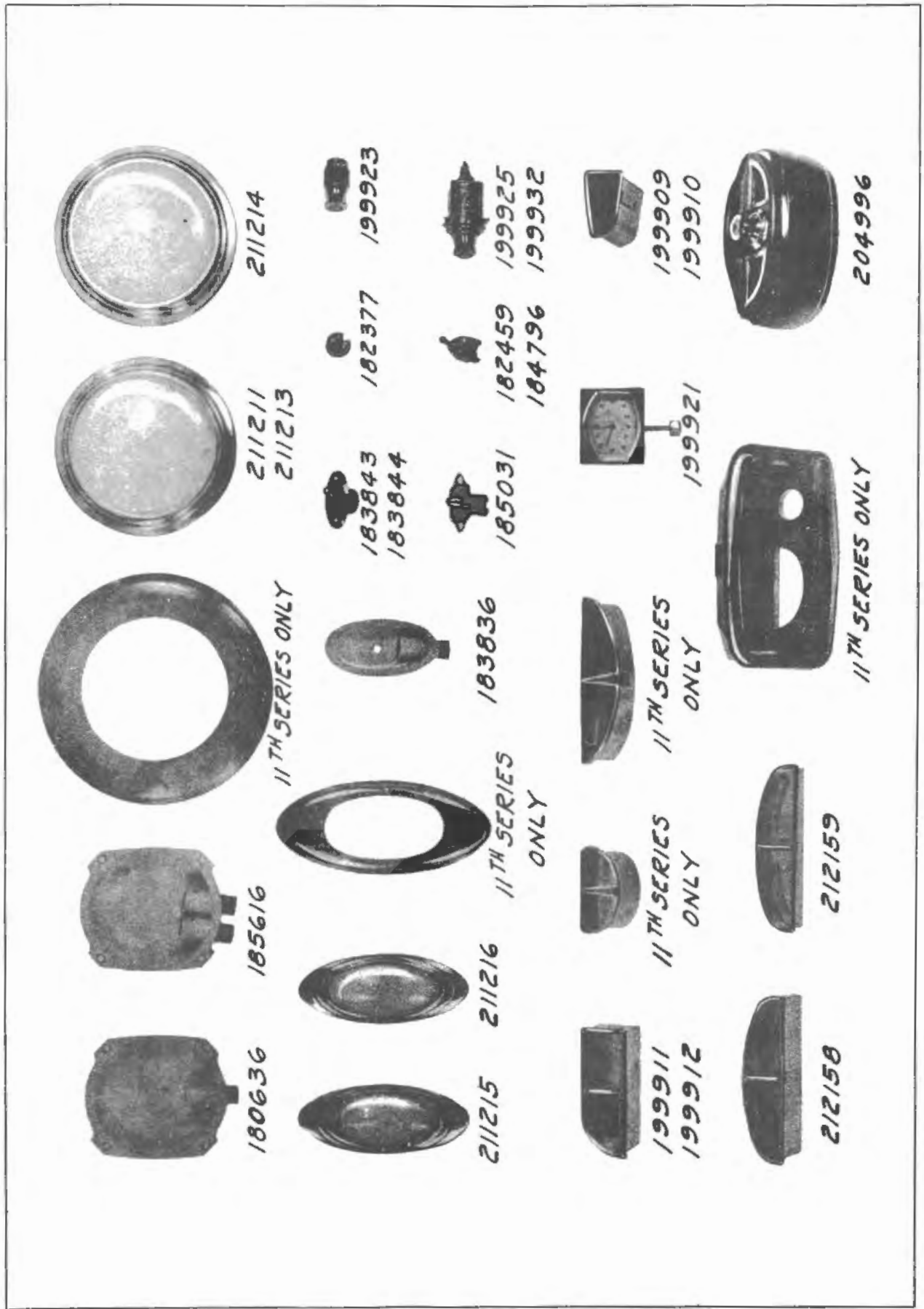

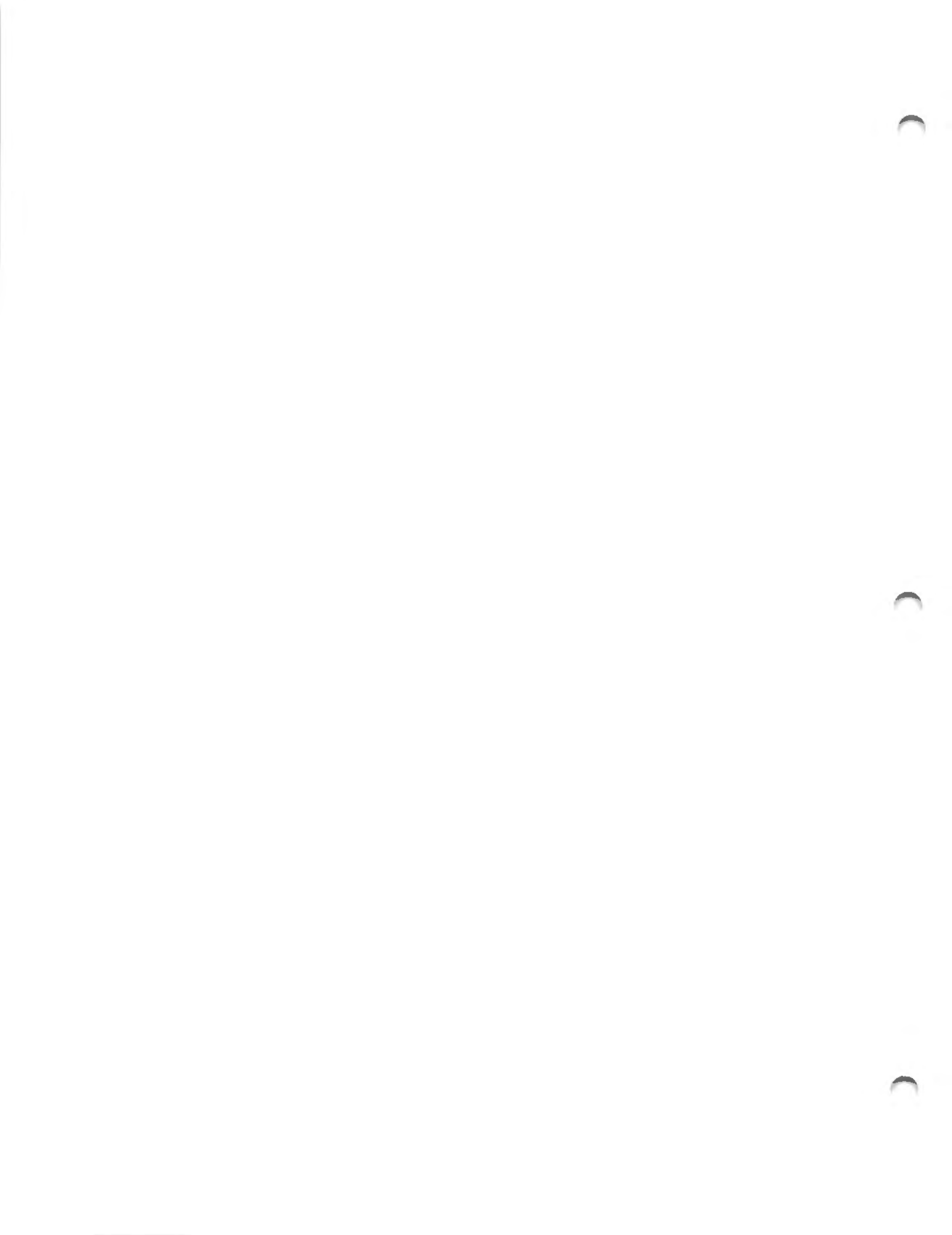

Piece No.	Name	No. Required													
		5633	5633A	633	634	635	636	637	638	639	643	647			
212390	Door hinge-lower right .....	-	-	-	-	-	-	-	-	-	-	-	-	-	1
212391	Door hinge-lower left .....	-	-	-	-	-	-	-	-	-	-	-	-	-	1
206178	Door hinge-front lower left .....	1	1	1	1	1	1	1	1	-	-	-	-	-	-
204711	Door hinge-front lower left .....	-	-	-	-	-	-	-	-	-	-	1	1	-	-
206177	Door hinge-front lower right .....	1	1	1	1	1	1	1	1	-	-	-	-	-	-
204710	Door hinge-front lower right .....	-	-	-	-	-	-	-	-	-	-	1	1	1	-
204713	Door hinge-front upper left .....	-	-	-	-	-	-	-	-	-	-	1	1	1	-
206176	Door hinge-front upper left .....	1	1	1	1	1	1	1	1	-	-	-	-	-	-
204712	Door hinge-front upper right .....	-	-	-	-	-	-	-	-	-	-	1	1	1	-
206175	Door hinge-front upper right .....	1	1	1	1	1	1	1	1	-	-	-	-	-	-
212402	Door hinge-rear center right .....	-	-	-	-	-	-	-	-	-	-	-	1	-	-
212403	Door hinge-rear center left .....	-	-	-	-	-	-	-	-	-	-	-	1	-	-
206296	Door hinge-rear lower right .....	1	1	-	-	-	-	-	-	-	-	-	-	-	-
212404	Door hinge-rear lower right .....	-	-	-	-	-	-	-	-	-	-	-	1	-	-
206181	Door hinge-rear lower right .....	-	-	1	1	1	1	-	-	-	-	-	-	-	-
206295	Door hinge-rear lower left .....	1	1	-	-	-	-	-	-	-	-	-	-	-	-
212405	Door hinge-rear lower left .....	-	-	-	-	-	-	-	-	-	-	-	1	-	-
206182	Door hinge-rear lower left .....	-	-	1	1	1	1	-	-	-	-	-	-	-	-
206179	Door hinge rear upper-right .....	1	1	1	1	1	1	-	-	-	-	-	-	-	-
212406	Door hinge rear upper-right .....	-	-	-	-	-	-	-	-	-	-	-	1	-	-
206180	Door hinge rear upper-left .....	1	1	1	1	1	1	-	-	-	-	-	-	-	-
212407	Door hinge rear upper-left .....	-	-	-	-	-	-	-	-	-	-	-	1	-	-
6148	Screw 1/4-28 x 1/2" oval hd. ....	-	-	-	-	-	-	-	-	-	-	24	-	-	-
206869	Screw 5/16-24 x 17/32" oval hd. ..	16	16	16	16	16	16	16	16	16	-	-	-	-	-
6074	Screw 1/4-28 x 1-1/8" flat hd. ...	4	4	4	4	4	4	-	-	-	-	-	-	-	-
5820	Screw 1/4-28 x 1-31/32" oval hd. .	4	4	4	4	4	4	-	-	-	-	-	-	-	-
8211	Screw 1/4-28 x 2-1/4" flat hd. ...	-	-	-	-	-	-	-	-	-	-	6	x	x	-
5701	Screw 1/4-28 x 9/16" flat hd. ....	16	16	16	16	16	16	16	16	16	-	-	-	-	-
5899	Lockwasher 5/16" countersunk Shakeproof (spec.) .....	32	32	32	32	32	32	32	32	32	32	24	24	24	-
206173	Door hinge pin .....	8	8	8	8	8	8	4	4	6	-	-	-	-	-
206174	Door hinge pin screw .....	8	8	8	8	8	8	4	4	6	-	-	-	-	-
5500	Door hinge pin lockwasher No. 10 std..	8	8	8	8	8	8	4	4	6	-	-	-	-	-
212468	Door hinge pin bushing .....	x	x	x	x	x	x	x	x	x	-	-	-	-	-
183170	Door lock front-right .....	1	1	1	1	1	1	1	1	1	-	-	1	-	-
193054	Door lock front-right .....	-	-	-	-	-	-	-	-	-	-	-	1	-	-
183171	Door lock front-left .....	1	1	1	1	1	1	1	1	1	-	-	1	-	-
193021	Door lock front-left .....	-	-	-	-	-	-	-	-	-	-	-	1	-	-
183171	Door lock rear-right .....	1	1	1	1	1	1	-	-	-	-	-	-	-	-
193021	Door lock rear-right .....	-	-	-	-	-	-	-	-	-	-	-	1	-	-
183170	Door lock rear-left .....	1	1	1	1	1	1	-	-	-	-	-	-	-	-
193054	Door lock rear-left .....	-	-	-	-	-	-	-	-	-	-	-	1	-	-
5829	Screw No. 10-32 x 7/8" flat hd. ..	8	8	8	8	8	8	4	4	4	-	-	-	-	-
5491	Lockwasher 3/16" countersunk (Shakeproof) .....	8	8	8	8	8	8	4	4	4	-	-	-	-	-
206005	Door lock handle .....	-	-	-	-	-	-	-	-	-	-	1	-	-	-
193174	Door lock handle .....	-	-	-	-	-	-	-	-	-	-	-	-	-	1
206010	Door lock handle (with key lock) .....	-	-	-	-	-	-	-	-	-	-	1	-	-	-
193177	Door lock handle (with key lock) .....	-	-	-	-	-	-	-	-	-	-	-	-	-	1
206009	Door lock handle front-left .....	1	1	1	1	1	1	1	1	-	-	-	-	-	-
206009	Door lock handle rear-right .....	-	-	1	1	-	1	-	-	-	-	-	-	-	-
193695	Door lock handle rear-right .....	-	-	-	-	-	-	-	-	-	-	-	1	-	-
206007	Door lock handle rear-left .....	1	1	1	1	1	1	-	-	-	-	-	-	-	-
193696	Door lock handle rear-left .....	-	-	-	-	-	-	-	-	-	-	-	1	-	-
206006	Door lock handle front-right (with key lock) .....	1	1	1	1	1	1	1	1	-	-	-	-	-	-
193692	Door lock handle front-right (with key lock) .....	-	-	-	-	-	-	-	-	-	-	-	1	-	-
193695	Door lock handle front-left .....	-	-	-	-	-	-	-	-	-	-	-	1	-	-
206008	Door lock handle rear-right (with key lock) .....	1	1	-	-	1	-	-	-	-	-	-	-	-	-

Piece No.	Name	No. Required										
		5633	5633A	633	634	635	636	637	638	639	643	647
212168	Door lock handle screw .....	2	2	1	1	2	1	1	1	1	-	1
5974	Door lock handle screw No. 10-32 x 7/8" oval hd. ....	-	-	-	-	-	-	-	-	-	8	-
185236	Washer .....	2	2	1	1	2	1	1	1	1	-	1
206188	Door lock handle attaching plate (Locking handle) .....	2	2	1	1	2	1	1	1	1	-	-
206223	Door lock handle attaching plate .....	2	2	3	3	2	3	1	1	1	-	-
206187	Door lock handle escutcheon plate ....	4	4	4	4	4	4	2	2	2	-	-
218430	Door lock remote control asb.-right ..	-	-	-	-	-	-	-	-	-	-	1
218431	Door lock remote control asb.-left ...	-	-	-	-	-	-	-	-	-	-	1
218432	Door lock remote control assembly front right .....	-	-	-	-	-	-	-	-	-	1	-
218433	Door lock remote control assembly front left .....	-	-	-	-	-	-	-	-	-	1	-
218434	Door lock remote control assembly rear right .....	-	-	-	-	-	-	-	-	-	1	-
218435	Door lock remote control assembly rear left .....	-	-	-	-	-	-	-	-	-	1	-
193076	Door lock remote control-right .....	-	-	-	-	-	-	-	-	1	-	-
193075	Door lock remote control-left .....	-	-	-	-	-	-	-	-	1	-	-
204482	Door lock remote control-front right .	-	-	1	-	-	1	1	1	-	-	-
204483	Door lock remote control-front left ..	-	-	1	-	-	1	1	1	-	-	-
204480	Door lock remote control-front right .	1	1	-	1	1	-	-	-	-	-	-
204481	Door lock remote control-front left ..	1	1	-	1	1	-	-	-	-	-	-
185650	Door lock remote control-rear right ..	-	-	1	-	-	1	-	-	-	-	-
185700	Door lock remote control-rear left ...	-	-	1	-	-	1	-	-	-	-	-
185710	Door lock remote control-rear right ..	1	1	-	1	1	-	-	-	-	-	-
185711	Door lock remote control-rear left ...	1	1	-	1	1	-	-	-	-	-	-
193918	Door lock remote control handle .....	4	4	4	4	4	4	2	2	2	4	2
193919	Door lock remote control handle escutcheon plate ....	4	4	4	4	4	4	2	2	2	4	2
193078	Door lock remote control handle escutcheon plate spring .....	4	4	4	4	4	4	2	2	2	4	2
206610	Door lock striker .....	4	4	4	4	4	4	-	-	-	-	-
206612	Door lock striker .....	-	-	-	-	-	-	2	2	-	-	-
206611	Door lock striker .....	-	-	-	-	-	-	-	-	2	4	2
170336	Door lock striker nut .....	2	2	2	2	2	2	-	-	-	-	-
182387	Door lock striker adjusting plate ....	4	4	4	4	4	4	-	-	-	-	-
170335	Door lock striker screw .....	2	2	2	2	2	2	-	-	-	-	-
204739	Door scuff plate-front-left .....	1	1	-	1	1	-	-	-	-	-	-
204737	Door scuff plate-front-left .....	-	-	1	-	-	1	1	1	-	-	-
195781	Door scuff plate-front left .....	-	-	-	-	-	-	-	-	-	1	-
193124	Door scuff plate-right .....	-	-	-	-	-	-	-	-	1	-	-
195778	Door scuff plate-right .....	-	-	-	-	-	-	-	-	-	-	1
193123	Door scuff plate-left .....	-	-	-	-	-	-	-	-	1	-	-
195779	Door scuff plate-left .....	-	-	-	-	-	-	-	-	-	-	1
204736	Door scuff plate-front right .....	-	-	1	-	-	1	1	1	-	-	-
195780	Door scuff plate-front right .....	-	-	-	-	-	-	-	-	-	1	-
204738	Door scuff plate-front right .....	1	1	-	1	1	-	-	-	-	-	-
206057	Door scuff plate-rear left .....	-	-	1	-	-	1	-	-	-	-	-
206055	Door scuff plate-rear left .....	-	-	-	1	1	-	-	-	-	-	-
212043	Door scuff plate-rear left .....	1	1	-	-	-	-	-	-	-	-	-
195787	Door scuff plate-rear left .....	-	-	-	-	-	-	-	-	-	1	-
206054	Door scuff plate-rear right .....	-	-	-	1	1	-	-	-	-	-	-
195786	Door scuff plate-rear right .....	-	-	-	-	-	-	-	-	-	1	-
212044	Door scuff plate-rear right .....	1	1	-	-	-	-	-	-	-	-	-
206056	Door scuff plate-rear right .....	-	-	1	-	-	1	-	-	-	-	-
193235	Door weatherstrip-front right .....	-	-	-	-	-	-	-	-	1	-	-
193234	Door weatherstrip-front left .....	-	-	-	-	-	-	-	-	1	-	-
193229	Door weatherstrip-rear right .....	-	-	-	-	-	-	-	-	1	-	-
193535	Door weatherstrip-rear left .....	-	-	-	-	-	-	-	-	1	-	-



206173 170335 170336 199167 204535 185600  
185601  
185602



119298 133919 206187 193078 164359 206188  
206223



184659 179680 206610 206611 182387  
206612



193918  
193123-193124-204736-204737-204738-204739  
206054-206055-206056-206057-212043-212044



185650-193076 204608-204609-204710 164699  
185700-204480 204711-204712-204713  
185710-204481 206175-206176-206177  
185711-204482 206178-206179-206180  
193075-204483 206181-206182-206295  
206296



206006 193174-193177 167250 183170 193021  
206007 193692-193695 183171 193054  
206008 193696  
206009  
206005  
206010

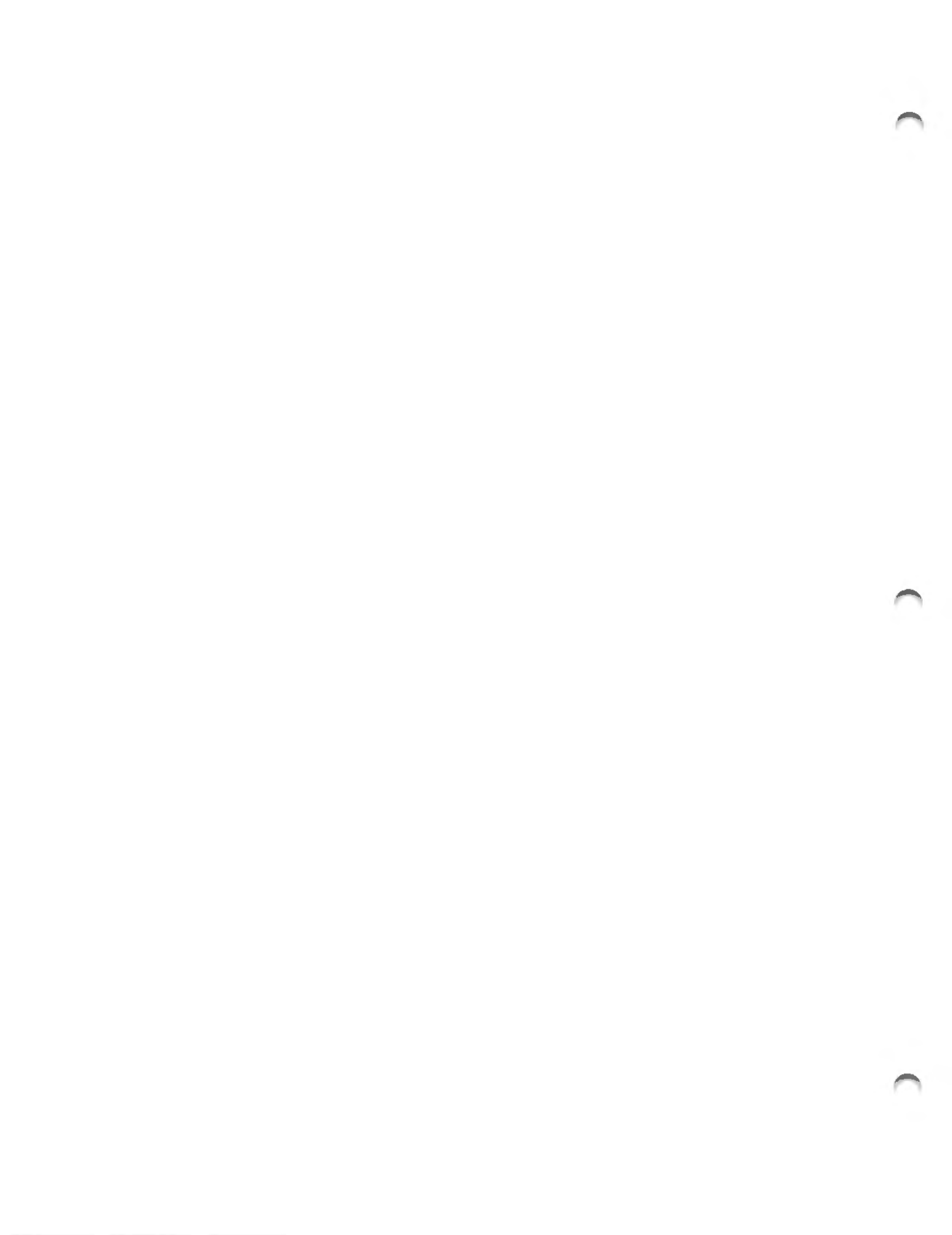

Piece No.	Name	No. Required												
		5633	5634A	633	634	635	636	637	638	639	643	647		
193233	Door weatherstrip upper-front right ..	-	-	-	-	-	-	-	-	-	-	1	-	-
193232	Door weatherstrip upper-front left ...	-	-	-	-	-	-	-	-	-	-	1	-	-
193231	Door weatherstrip upper-rear right ...	-	-	-	-	-	-	-	-	-	-	1	-	-
193230	Door weatherstrip upper-rear left ....	-	-	-	-	-	-	-	-	-	-	1	-	-

FASTENERS

195340	Fastener double prong-top rear curtain	-	-	-	-	-	-	-	-	-	-	X	-	-
195664	Fastener eyelet-top rear curtain .....	-	-	-	-	-	-	-	-	-	-	X	-	-
195341	Fastener stud screw base-top rear curtain .....	-	-	-	-	-	-	-	-	-	-	X	-	-
195683	Rivet No. 2504 - 9/64 x 1/4" flat hd. tubular .....	-	-	-	-	-	-	-	-	-	-	X	-	-
177609	Fastener washer-top rear curtain .....	-	-	-	-	-	-	-	-	-	-	X	-	-
181792	Fastener washer-top rear curtain .....	-	-	-	-	-	-	-	-	-	-	X	-	-
193200	Snap fastener machine screw post- carpet front floor .....	X	X	X	X	X	X	X	X	X	X	X	-	-
111075	Snap fastener rivet post-rumble seat compartment door hinge cover .....	-	-	-	-	-	-	-	-	-	X	X	-	-
193199	Snap fastener rivet post-female- carpet front floor .....	X	X	X	X	X	X	X	X	X	X	X	-	-
193201	Snap fastener screw post-carpet front floor .....	X	X	X	X	X	X	X	X	X	X	X	-	-
159060	Snap fastener screw stud (self tapping) - carpet front floor .....	X	X	X	X	X	X	X	X	X	X	X	-	-
115799	Snap fastener socket-carpet front floor .....	-	-	-	-	-	-	-	-	-	-	X	-	-
200073	Snap fastener socket rumble seat compartment door hinge cover .....	-	-	-	-	-	-	-	-	-	X	X	-	-
200073	Snap fastener socket-rumble seat compartment floor carpet .....	-	-	-	-	-	-	-	-	-	X	X	-	-
206744	Snap fastener screw post-rumble seat compartment floor .....	-	-	-	-	-	-	-	-	-	X	X	-	-
111074	Snap fastener stud-rumble seat compartment door hinge cover .....	-	-	-	-	-	-	-	-	-	X	X	-	-
185411	Snap fastener wood screw stud-rear deck trim rail .....	-	-	-	-	-	-	-	-	-	-	X	-	-
185412	Snap fastener wood screw stud-front seat back rail .....	-	-	-	-	-	-	-	-	-	-	X	-	-
139150	Snap fastener socket-top envelope ....	-	-	-	-	-	-	-	-	-	-	X	-	-
139150	Snap fastener socket-top side rail ...	-	-	-	-	-	-	-	-	-	-	X	-	-
139150	Snap fastener socket-body lock pillar.	-	-	-	-	-	-	-	-	-	-	X	-	-
5729	Screw No. 4-40 x 5/16" .....	-	-	-	-	-	-	-	-	-	-	X	-	-
139157	Snap fastener rivet stud-top side quarter .....	-	-	-	-	-	-	-	-	-	-	X	-	-
139157	Snap fastener rivet stud-top envelope.	-	-	-	-	-	-	-	-	-	-	X	-	-
175757	Snap fastener rivet post-top envelope.	-	-	-	-	-	-	-	-	-	-	X	-	-
175757	Snap fastener rivet post top side quarter .....	-	-	-	-	-	-	-	-	-	-	X	-	-

FLOOR BOARD

196337	Floor board battery lid .....	-	-	-	-	-	-	-	1	-	-	-	-	1
206478	Floor board front assembly .....	1	1	1	-	-	-	1	-	1	1	1	-	-
206478	Floor board front assembly .....	-	-	-	-	-	-	-	1	-	-	-	-	1
206477	Floor board front assembly .....	-	-	-	1	1	-	-	-	-	-	-	-	-
206481	Floor board front felt-front .....	1	1	1	1	1	1	1	1	1	1	1	1	1
206480	Floor board front felt-center .....	1	1	1	1	1	1	1	1	1	1	1	1	1
206479	Floor board front felt-rear .....	1	1	1	1	1	1	1	1	1	1	1	1	1



Piece No.	Name	No. Required										
		5633	5633A	633	634	635	636	637	638	639	643	647
206482	Floor board front felt-side .....	2	2	2	-	-	2	-	2	2	-	-
206483	Floor board front felt-side .....	-	-	-	2	2	-	-	-	-	-	-
206484	Floor board front felt-side .....	-	-	-	-	-	-	2	-	-	-	-
206572	Floor board rear assembly .....	1	1	1	-	-	-	-	-	-	-	-
206571	Floor board rear assembly .....	-	-	-	1	1	-	-	-	-	-	-

### FLOOR CARPET

Specify color and type of binding when ordering carpet

204621	Floor carpet front assembly .....	-	-	1	-	-	1	-	1	-	-	-
204624	Floor carpet front assembly .....	-	-	-	-	-	-	-	-	1	-	-
212428	Floor carpet front assembly .....	-	-	-	-	-	-	-	-	-	1	-
212429	Floor carpet front assembly .....	-	-	-	-	-	-	-	-	-	-	1
204625	Floor carpet front assembly .....	-	-	-	-	-	-	1	-	-	-	-
204626	Floor carpet front assembly .....	-	-	-	1	-	-	-	-	-	-	-
211889	Floor carpet front assembly .....	1	1	-	-	1	-	-	-	-	-	-
211167	Floor carpet rear assembly .....	-	-	1	-	-	-	-	-	-	-	-
212430	Floor carpet rear assembly .....	-	-	-	-	-	-	-	-	-	1	-
212431	Floor carpet rear assembly .....	-	-	-	-	-	-	-	-	-	-	1
211168	Floor carpet rear assembly .....	-	-	-	1	1	-	-	-	-	-	-
212045	Floor carpet rear assembly .....	1	1	-	-	-	-	-	-	-	-	-
211169	Floor carpet rear assembly .....	-	-	-	-	-	1	-	-	-	-	-
211170	Floor carpet rear assembly .....	-	-	-	-	-	-	1	-	-	-	-
172754	Floor carpet rear compartment assembly .....	-	-	-	-	-	-	1	-	-	-	-
195301	Floor carpet rumble compartment assembly .....	-	-	-	-	-	-	-	-	1	-	-
195300	Floor carpet rumble compartment assembly .....	-	-	-	-	-	-	-	-	1	-	-

### FOLDING ARM REST

193141	Folding arm rest cushion .....	-	-	-	-	-	-	1	-	-	-	-
187134	Folding arm rest cushion .....	1	1	1	1	1	1	-	-	-	1	1
185784	Folding arm rest spring .....	1	1	1	1	1	1	-	-	-	-	-
193329	Folding arm rest spring .....	-	-	-	-	-	-	1	-	-	-	-
187544	Folding arm rest support bracket assembly .....	-	-	-	-	-	1	-	-	-	-	-
185826	Folding arm rest support bracket assembly .....	1	1	-	1	1	-	-	-	-	-	-
187221	Folding arm rest support bracket assembly .....	-	-	1	-	-	-	-	-	-	1	-
193133	Folding arm rest support bracket assembly .....	-	-	-	-	-	-	1	-	-	-	1
171580	Screw No. 10-32 x 5/8" flat hd. mach. ....	6	6	6	6	6	6	6	-	-	-	-
7824	Screw 1/4-28 x 5/8" hex. hd. ....	4	4	4	4	4	4	2	-	-	4	4
5992	Screw 1/4-28 x 1-5/8" hex. hd. ...	-	-	-	-	-	-	2	-	-	-	-
5502	Lockwasher 1/4" std. ....	4	4	4	4	4	4	4	-	-	4	4
7004	Nut 1/4-28 .....	4	4	4	4	4	4	4	-	-	4	4

Piece No.	Name	No. Required										
		5633	5633A	633	634	635	636	637	638	639	643	647
<b>FOLDING SEAT</b>												
Always send samples of material when ordering folding seat trimmed assemblies as the assemblies are upholstered to match the body interior.												
204654	Folding seat trimmed assembly .....	-	-	-	2	2	-	-	-	-	-	-
212047	Folding seat trimmed assembly right (Folding Type) .....	1	-	-	-	-	-	-	-	-	-	-
212340	Folding seat trimmed assembly right (Drop seat) .....	1	-	-	-	-	-	-	-	-	-	-
212048	Folding seat trimmed assembly left (Folding Type) .....	1	-	-	-	-	-	-	-	-	-	-
212341	Folding seat trimmed assembly left (Drop seat) .....	1	-	-	-	-	-	-	-	-	-	-
187498	Folding seat untrimmed assembly .....	-	-	-	2	2	-	-	-	-	-	-
193881	Folding seat untrimmed assembly right (Folding Type) .....	1	-	-	-	-	-	-	-	-	-	-
212342	Folding seat untrimmed assembly right (Drop seat) .....	1	-	-	-	-	-	-	-	-	-	-
193880	Folding seat untrimmed assembly left (Folding Type) .....	1	-	-	-	-	-	-	-	-	-	-
212343	Folding seat untrimmed assembly left (Drop seat) .....	1	-	-	-	-	-	-	-	-	-	-
169102	Folding seat back untrimmed assembly .	-	-	-	2	2	-	-	-	-	-	-
167945	Folding seat back to seat frame screw.	-	-	-	4	4	-	-	-	-	-	-
172294	Folding seat cushion spring .....	-	-	-	2	2	-	-	-	-	-	-
211377	Folding seat floor carpet assembly ...	-	-	-	2	2	-	-	-	-	-	-
171692	Folding seat frame assembly .....	-	-	-	2	2	-	-	-	-	-	-
5580	Screw No. 10-32 x 1" flat hd. ....	-	-	-	16	16	-	-	-	-	-	-
5229	Screw 1/4-28 x 1-3/8" flat hd. ...	-	-	-	8	8	-	-	-	-	-	-
8220	Screw 1/4-28 x 1-1/2" flat hd. ...	-	-	-	8	8	-	-	-	-	-	-
7003	Nut No. 10-32 .....	-	-	-	16	16	-	-	-	-	-	-
7004	Nut 1/4-28 .....	-	-	-	16	16	-	-	-	-	-	-
3867	Washer 3/16" .....	-	-	-	4	4	-	-	-	-	-	-
171698	Folding seat frame side-left .....	-	-	-	2	2	-	-	-	-	-	-
171703	Folding seat frame side-right .....	-	-	-	2	2	-	-	-	-	-	-
187774	Folding seat handle .....	-	-	-	2	2	-	-	-	-	-	-
100100	Folding seat pivot pin .....	-	-	-	4	4	-	-	-	-	-	-
187421	Folding seat pivot pin retainer .....	-	-	-	2	2	-	-	-	-	-	-
8204	Screw 1/4-28 x 2" flat hd. ....	-	-	-	4	4	-	-	-	-	-	-
187410	Folding seat support-left .....	-	-	-	2	2	-	-	-	-	-	-
187411	Folding seat support-right .....	-	-	-	2	2	-	-	-	-	-	-
130869	Folding seat support to seat frame screw .....	-	-	-	4	4	-	-	-	-	-	-
7006	Nut 3/8-24 .....	-	-	-	4	4	-	-	-	-	-	-
5506	Lockwasher 3/8" .....	-	-	-	4	4	-	-	-	-	-	-

**FOOT REST**

206140	Foot rest assembly .....	-	-	1	1	1	-	-	-	-	-	-
79574	Foot rest assembly .....	-	-	-	-	-	-	-	1	1	-	-
8013	Screw No. 10-32 x 1-1/8" oval hd. mach. ....	-	-	4	4	4	-	-	-	-	-	-
206133	Foot rest bar .....	-	-	1	1	1	-	-	-	-	-	-
206134	Foot rest bar cushion .....	-	-	1	1	1	-	-	-	-	-	-
206136	Foot rest bar end bracket left .....	-	-	1	1	1	-	-	-	-	-	-
206090	Foot rest bar end bracket right .....	-	-	1	1	1	-	-	-	-	-	-
206139	Foot rest bar end to support screw ...	-	-	2	2	2	-	-	-	-	-	-

Piece No.	Name	No. Required										
		5633	5633A	633	634	635	636	637	638	639	643	647
195201	Foot rest bar end to support screw washer .....	-	-	2	2	2	-	-	-	-	-	-
6048	Lockwasher 3/8" Shakeproof .....	-	-	2	2	2	-	-	-	-	-	-
122146	Foot rest pivot stud .....	-	-	-	-	-	-	-	2	2	-	-
180134	Nut-blind .....	-	-	-	-	-	-	-	2	2	-	-
206143	Foot rest support .....	-	-	2	2	2	-	-	-	-	-	-
147114	Foot rest support bracket .....	-	-	-	-	-	-	-	2	2	-	-
206141	Foot rest support bracket .....	-	-	2	2	2	-	-	-	-	-	-
206217	Foot rest support bracket pin .....	-	-	2	2	2	-	-	-	-	-	-
206130	Foot rest support bracket cushion ....	-	-	2	2	2	-	-	-	-	-	-
206132	Foot rest support cushion .....	-	-	2	2	2	-	-	-	-	-	-
214561	Foot rest support bracket screw .....	-	-	2	2	2	-	-	-	-	-	-

## FRONT SEAT

122611	Front seat back compartment door hinge	-	-	-	-	-	-	-	-	2	-	-
114525	Front seat back compartment lid lifter	-	-	-	-	-	-	-	1	1	-	-
195236	Front seat left-back spring .....	-	-	1	1	-	1	-	1	-	-	-
193070	Front seat left-back spring .....	-	-	-	-	-	-	-	-	1	-	-
181966	Front seat back spring .....	1	1	-	-	1	-	-	-	-	-	-
195249	Front seat back spring .....	-	-	-	-	-	-	2	-	-	-	-
195238	Front seat right-back spring .....	-	-	1	1	-	1	-	1	-	-	-
193071	Front seat right-back spring .....	-	-	-	-	-	-	-	-	1	-	-
199749	Front seat compartment bottom battery cover assembly .....	-	-	-	-	-	-	-	-	1	1	-
199641	Front seat compartment bottom battery cover .....	1	1	1	1	1	1	-	1	-	-	-
196311	Front seat compartment bottom battery cover clamp .....	2	2	2	2	2	2	-	2	-	-	-
7906	Screw 1/4-28 x 3/4" rnd. hd. ....	2	2	2	2	2	2	-	2	-	-	-
199045	Front seat compartment bottom battery cover clamp screw clinch nut 1/4-28 thd. ....	2	2	2	2	2	2	-	2	-	-	-
199643	Front seat compartment bottom battery cover gasket .....	1	1	1	1	1	1	-	1	-	-	-
181695	Front seat right-counterbalance assembly .....	-	-	-	-	-	-	1	-	-	-	-
5823	Screw 1/4-28 x 1-1/8" oval hd. ...	-	-	-	-	-	-	3	-	-	-	-
5502	Lockwasher 1/4" std. ....	-	-	-	-	-	-	3	-	-	-	-
7004	Nut 1/4-28 .....	-	-	-	-	-	-	3	-	-	-	-
62065	Washer 1/4" spec. ....	-	-	-	-	-	-	3	-	-	-	-
181703	Front seat right-counterbalance spring left .....	-	-	-	-	-	-	1	-	-	-	-
181702	Front seat right-counterbalance spring right .....	-	-	-	-	-	-	1	-	-	-	-
181989	Front seat right-counterbalance spring adjusting lever .....	-	-	-	-	-	-	2	-	-	-	-
181697	Front seat right-counterbalance spring lever and pin assembly .....	-	-	-	-	-	-	1	-	-	-	-
5822	Front seat right-counterbalance spring adjusting lever screw 1/4-28 x 5/8" hex. hd. ....	-	-	-	-	-	-	2	-	-	-	-
5502	Lockwasher 1/4" std. ....	-	-	-	-	-	-	2	-	-	-	-
7004	Nut 1/4-28 .....	-	-	-	-	-	-	2	-	-	-	-

NOTE:--Always send samples of material when ordering cushion assemblies, as the assemblies are upholstered to match the body interior.

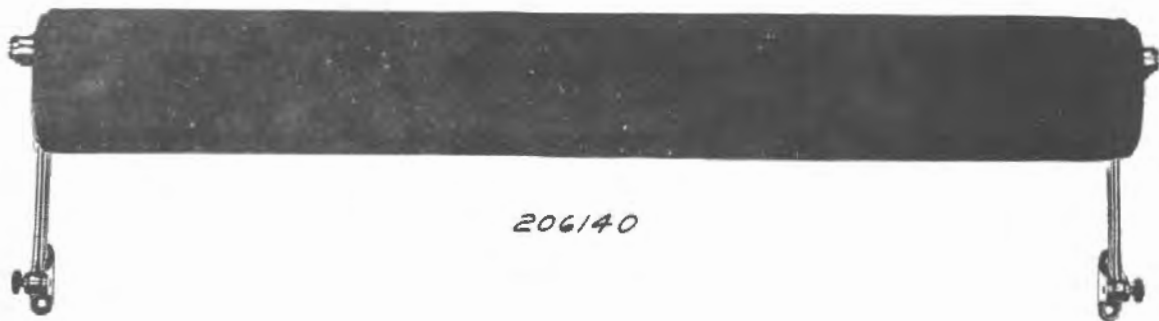

206140



206132



206130



206141



214561



147114



122146

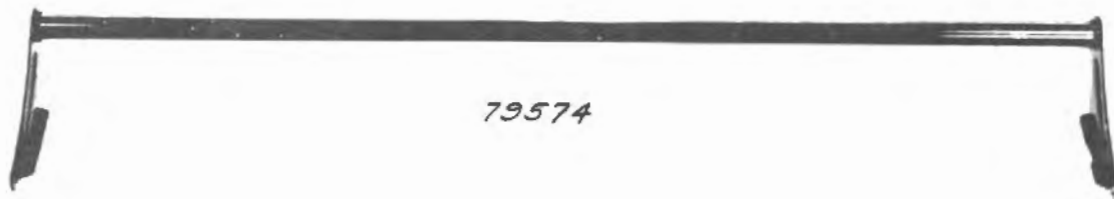

79574

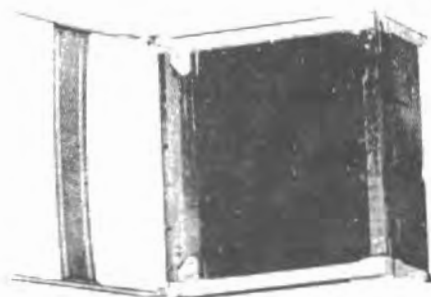

187498

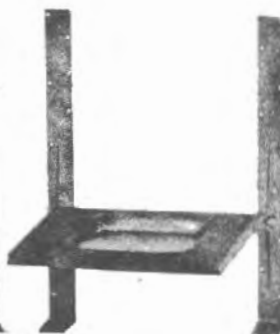

212342



212343

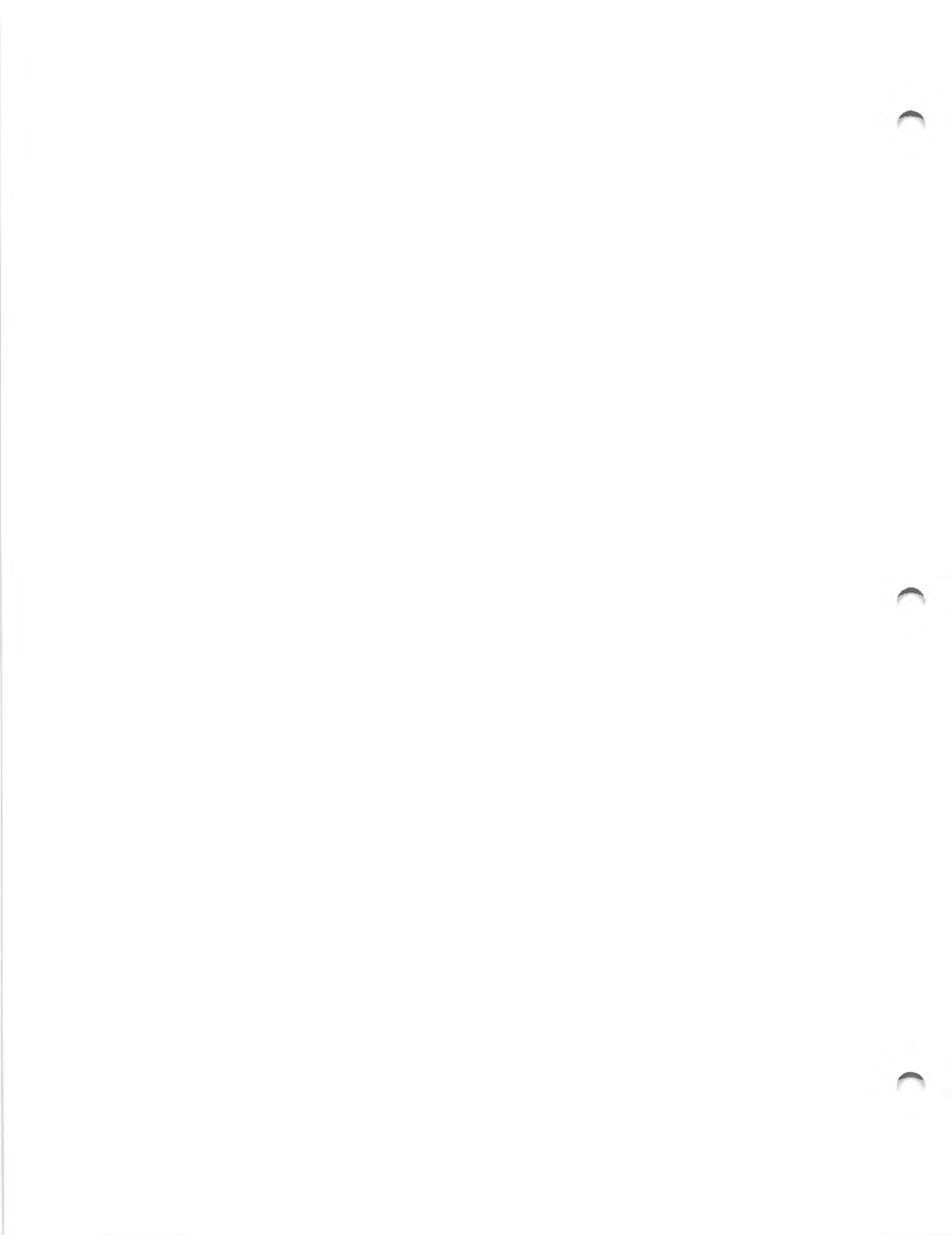

Piece No.	Name	No. Required											
		5633	5633A	633	634	635	636	637	638	639	643	647	
187258	Front seat cushion assembly .....	-	-	-	-	1	-	-	-	-	-	-	-
212370	Front seat cushion assembly .....	1	1	-	-	-	-	-	-	-	-	-	-
193293	Front seat left-cushion assembly .....	-	-	-	-	-	-	-	-	1	-	-	-
204864	Front seat left-cushion assembly .....	-	-	-	-	-	-	1	-	-	-	-	-
204865	Front seat left-cushion assembly .....	-	-	1	1	-	1	-	1	-	-	-	-
193297	Front seat right-cushion assembly .....	-	-	-	-	-	-	-	-	1	-	-	-
204866	Front seat right-cushion assembly .....	-	-	-	-	-	-	1	-	-	-	-	-
204867	Front seat right-cushion assembly .....	-	-	1	1	-	1	-	1	-	-	-	-
181141	Front seat cushion dowel female .....	4	4	4	4	2	4	-	4	4	-	2	-
181036	Front seat cushion dowel male .....	4	4	4	4	2	4	-	4	4	-	2	-
181965	Front seat cushion spring .....	1	1	-	-	1	-	-	-	-	-	-	-
195253	Front seat right-cushion spring .....	-	-	-	-	-	-	1	-	-	-	-	-
195252	Front seat left-cushion spring .....	-	-	-	-	-	-	1	-	-	-	-	-
181044	Front seat left-cushion spring .....	-	-	1	1	-	1	-	1	-	-	-	-
187911	Front seat left-cushion spring .....	-	-	-	-	-	-	-	-	1	-	-	-
181043	Front seat right-cushion spring .....	-	-	1	1	-	1	-	1	-	-	-	-
193026	Front seat right-cushion spring .....	-	-	-	-	-	-	-	-	1	-	-	-
173149	Front seat hinge .....	-	-	-	-	-	-	2	-	-	-	-	-
7610	Bolt 1/4-28 x 2-1/8" carriage .....	-	-	-	-	-	-	8	-	-	-	-	-
5817	Lockwasher 1/4" Shakeproof .....	-	-	-	-	-	-	8	-	-	-	-	-
7004	Nut 1/4-28 .....	-	-	-	-	-	-	8	-	-	-	-	-
181686	Front seat left-lever ratchet .....	-	-	-	-	-	-	1	-	-	-	-	-
173150	Front seat left-locking lever .....	-	-	-	-	-	-	1	-	-	-	-	-
173513	Front seat left-locking lever pin .....	-	-	-	-	-	-	1	-	-	-	-	-
173313	Front seat left-locking lever spring .....	-	-	-	-	-	-	1	-	-	-	-	-
199722	Front seat left-locking spring .....	-	-	1	1	-	1	-	1	-	-	-	-
187739	Front seat left-locking spring .....	-	-	-	-	-	-	-	-	1	1	-	-
187736	Front seat left-operating handle assembly .....	-	-	-	-	-	-	-	-	1	1	-	-
146103	Spring .....	-	-	-	-	-	-	-	-	1	1	-	-
3912	Washer 7/16" .....	-	-	-	-	-	-	-	-	1	1	-	-
4290	Pin 3/32 x 5/8" spring cotter .....	-	-	-	-	-	-	-	-	1	1	-	-
5502	Lockwasher 1/4" std. ....	-	-	-	-	-	-	-	-	1	1	-	-
7004	Nut 1/4-28 .....	-	-	-	-	-	-	-	-	1	1	-	-
199718	Front seat left-operating spring .....	-	-	1	1	-	1	-	1	1	1	-	-
180845	Front seat left-support bar assembly .....	-	-	1	1	-	1	-	1	-	-	-	-
180844	Front seat left-support bar handle ...	-	-	1	1	-	1	-	1	-	-	-	-

GOLF COMPARTMENT

193310	Golf compartment door trimmed assembly	-	-	-	-	-	-	-	1	1	-	-	-
111671	Golf compartment door bumper .....	-	-	-	-	-	-	-	2	2	-	-	-
111672	Golf compartment door bumper socket ..	-	-	-	-	-	-	-	2	2	-	-	-
163766	Golf compartment door hinge .....	-	-	-	-	-	-	-	1	1	-	-	-
163767	Golf compartment door lock .....	-	-	-	-	-	-	-	1	1	-	-	-
143615	Golf compartment door lock striker ...	-	-	-	-	-	-	-	1	1	-	-	-

HAND BRAKE CUTOUT COVER

204455	Hand brake lever cutout cover .....	1	1	1	1	1	1	1	1	1	1	1	1
--------	-------------------------------------	---	---	---	---	---	---	---	---	---	---	---	---

HASSOCK

135807	Hassock .....	2	2	-	-	-	2	-	-	-	-	-	-
--------	---------------	---	---	---	---	---	---	---	---	---	---	---	---

Piece No.	Name	No. Required										
		5633	5633A	633	634	635	636	637	638	639	643	647
<b>MOULDING</b>												
204780	Moulding cowl rail finishing .....	-	-	-	-	-	-	-	-	1	-	-
206279	Moulding cowl rail finishing ash receiver .....	-	-	-	-	-	-	-	-	1	1	1
211504	Moulding door window finishing right ..	-	-	-	-	-	-	-	1	-	-	-
204788	Moulding door window finishing right ..	-	-	-	-	-	-	-	-	1	-	-
204789	Moulding door window finishing left ..	-	-	-	-	-	-	-	-	1	-	-
211503	Moulding door window finishing left ..	-	-	-	-	-	-	-	1	-	-	-
211430	Moulding door window finishing front right .....	-	-	1	-	-	1	1	-	-	-	-
211548	Moulding door window finishing front right .....	1	1	-	1	1	-	-	-	-	-	-
211429	Moulding door window finishing front left .....	-	-	1	-	-	1	1	-	-	-	-
211549	Moulding door window finishing front left .....	1	1	-	1	1	-	-	-	-	-	-
204814	Moulding door window finishing rear right .....	1	1	-	1	1	-	-	-	-	-	-
204816	Moulding door window finishing rear right .....	-	-	1	-	-	1	-	-	-	-	-
204815	Moulding door window finishing rear left .....	1	1	-	1	1	-	-	-	-	-	-
204817	Moulding door window finishing rear left .....	-	-	1	-	-	1	-	-	-	-	-
204823	Moulding partition window finishing ..	-	-	-	-	1	-	-	-	-	-	-
166426	Moulding-rear platform 44-1/2" long ..	-	-	-	-	-	1	-	-	-	-	-
204831	Moulding rear window finishing .....	-	1	1	1	1	1	1	-	-	-	-
212049	Moulding rear window finishing .....	1	-	-	-	-	-	-	-	-	-	-
204833	Moulding rear window finishing .....	-	-	-	-	-	-	-	1	-	-	-
204842	Moulding roof joint 78" long .....	-	-	-	-	-	-	-	2	-	-	-
204837	Moulding roof joint 122-1/2" long ....	-	2	2	-	-	-	-	-	-	-	-
204841	Moulding roof joint 99" long .....	-	-	-	-	-	-	2	-	-	-	-
212050	Moulding roof joint 60" long .....	1	-	-	-	-	-	-	-	-	-	-
204839	Moulding roof joint 134-1/2" long ....	-	-	-	2	2	-	-	-	-	-	-
204840	Moulding roof joint 113-1/2" long ....	-	-	-	-	-	2	-	-	-	-	-
211696	Moulding side window finishing right ..	-	-	1	-	-	-	-	-	-	-	-
212160	Moulding side window finishing right (Cigar lighter at rear of ash receivers) .....	-	-	-	1	1	-	-	-	-	-	-
211715	Moulding side window finishing left (Cigar lighter between ash receivers) .....	-	-	-	1	1	-	-	-	-	-	-
212203	Moulding side window finishing right ..	-	1	-	-	-	-	-	-	-	-	-
204854	Moulding side window finishing right ..	-	-	-	-	-	-	1	-	-	-	-
204855	Moulding side window finishing left ..	-	-	-	-	-	-	1	-	-	-	-
211695	Moulding side window finishing left ..	-	-	1	-	-	-	-	-	-	-	-
212204	Moulding side window finishing left ..	-	1	-	-	-	-	-	-	-	-	-
212161	Moulding side window finishing left (Cigar lighter at rear of ash receiver) .....	-	-	-	1	1	-	-	-	-	-	-
211716	Moulding side window finishing right. (Cigar lighter between ash receivers) .....	-	-	-	1	1	-	-	-	-	-	-
206049	Moulding windshield header assembly ..	1	1	1	1	1	1	1	1	-	-	-
5587	Screw No. 10-32 x 3/8" oval hd. ..	2	2	2	2	2	2	2	2	-	-	-
185676	Screw ferrule No. 10 std. ....	2	2	2	2	2	2	2	2	-	-	-
204889	Moulding windshield opening .....	1	1	1	1	1	1	1	1	-	-	-
5739	Moulding windshield opening screw No. 10-32 x 1/2" hex. hd. ....	6	6	6	6	6	6	6	6	-	-	-
6056	Lockwasher 3/16" (Shakeproof) ....	6	6	6	6	6	6	6	6	-	-	-
206279	Moulding windshield opening ash receiver .....	1	1	1	1	1	1	1	1	-	-	-



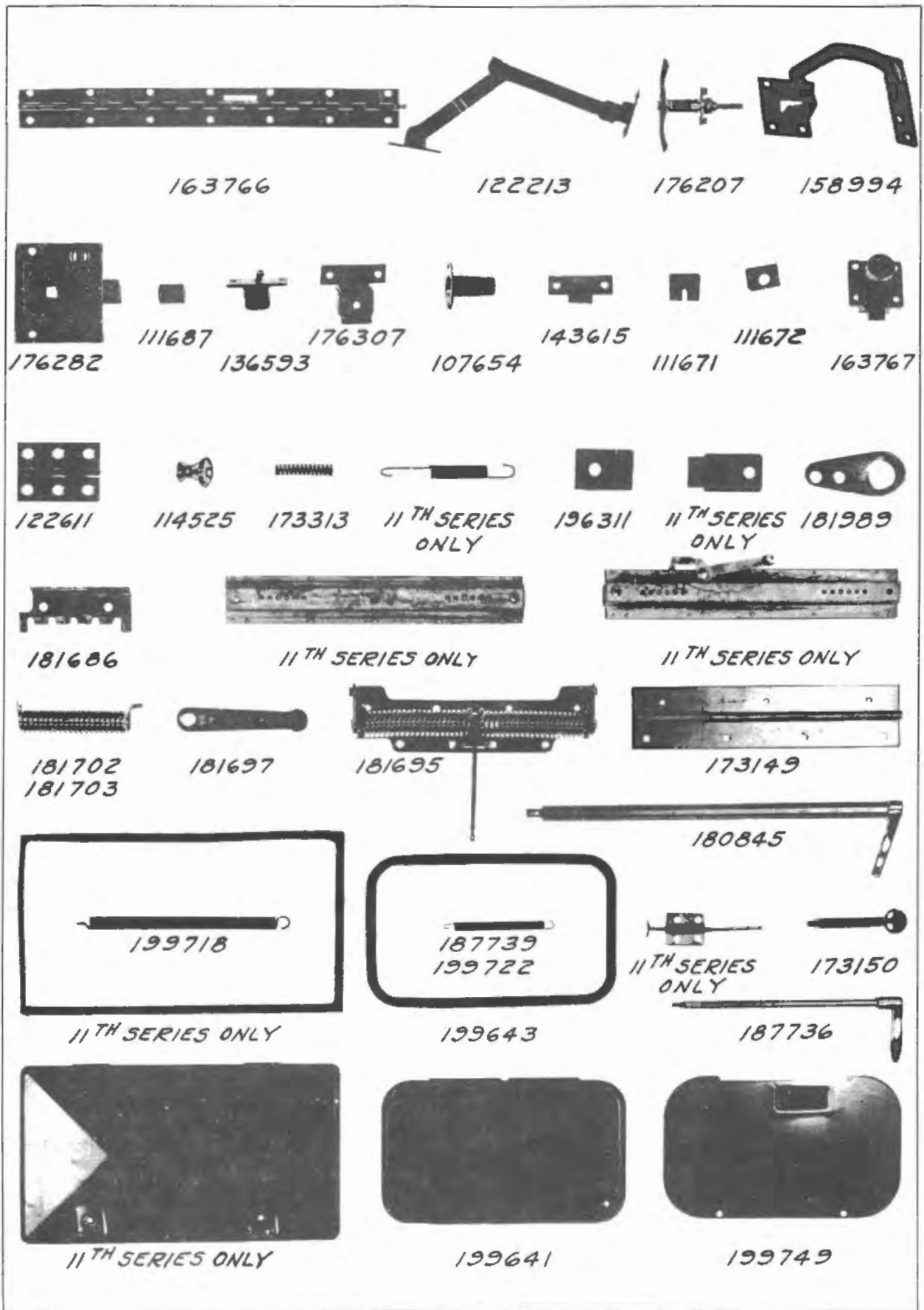

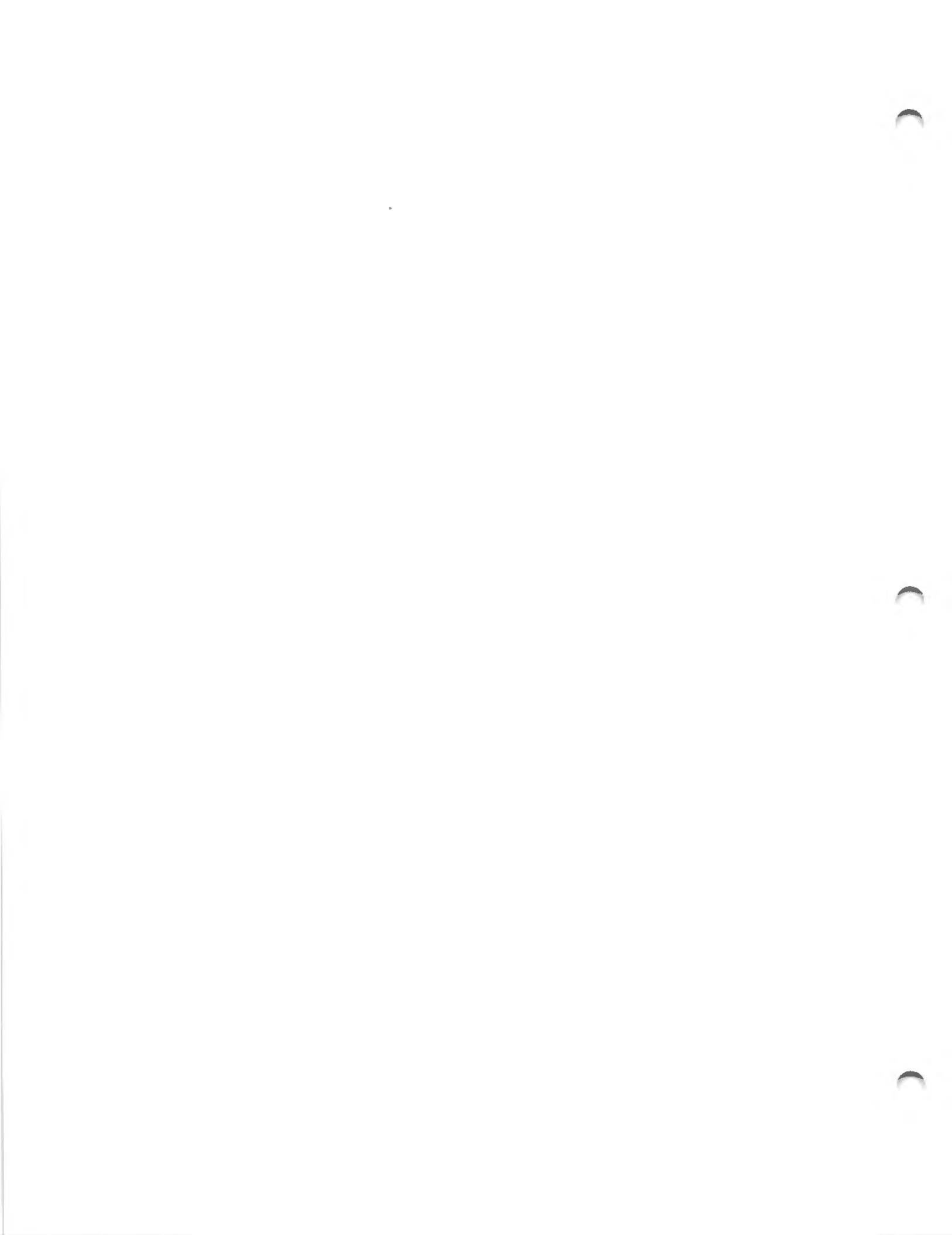

Piece No.	Name	No. Required										
		5633	5633A	633	634	635	636	637	638	639	643	647
<b>PANEL</b>												
204452	Panel cowl assembly .....	1	1	1	1	1	1	1	1	-	-	-
204453	Panel cowl assembly .....	-	-	-	-	-	-	-	-	1	1	1
206500	Panel dash assembly .....	-	-	-	-	-	-	-	-	1	1	1
204676	Panel dash assembly .....	1	1	1	1	1	1	1	1	-	-	-
204679	Panel dash cover assembly .....	1	1	1	1	1	1	1	1	-	-	-
206503	Panel dash cover assembly .....	-	-	-	-	-	-	-	-	1	1	1
204681	Panel dash inter-liner .....	1	1	1	1	1	1	1	1	-	-	-
206492	Panel dash inter-liner .....	-	-	-	-	-	-	-	-	1	1	1
204682	Panel dash liner .....	1	1	1	1	1	1	1	1	-	-	-
206493	Panel dash liner .....	-	-	-	-	-	-	-	-	1	1	1
204448	Panel door right assembly .....	-	-	-	-	-	-	-	1	-	-	-
212420	Panel door right assembly .....	-	-	-	-	-	-	-	-	-	-	1
195692	Panel door right assembly .....	-	-	-	-	-	-	-	-	1	-	-
204449	Panel door left assembly .....	-	-	-	-	-	-	-	1	-	-	-
195691	Panel door left assembly .....	-	-	-	-	-	-	-	-	1	-	-
212421	Panel door left assembly .....	-	-	-	-	-	-	-	-	-	-	1
204436	Panel door front right assembly .....	-	-	1	-	-	1	1	-	-	-	-
212422	Panel door front right assembly .....	-	-	-	-	-	-	-	-	-	1	-
204428	Panel door front right assembly .....	1	1	-	1	1	-	-	-	-	-	-
204437	Panel door front left assembly .....	-	-	1	-	-	1	1	-	-	-	-
212423	Panel door front left assembly .....	-	-	-	-	-	-	-	-	-	1	-
204429	Panel door front left assembly .....	1	1	-	1	1	-	-	-	-	-	-
204444	Panel door rear right assembly .....	-	-	-	-	-	1	-	-	-	-	-
212424	Panel door rear right assembly .....	-	-	-	-	-	-	-	-	-	1	-
204438	Panel door rear right assembly .....	-	-	1	-	-	-	-	-	-	-	-
212057	Panel door rear right assembly .....	1	1	-	-	-	-	-	-	-	-	-
204430	Panel door rear right assembly .....	-	-	-	1	1	-	-	-	-	-	-
204431	Panel door rear left assembly .....	-	-	-	1	1	-	-	-	-	-	-
204439	Panel door rear left assembly .....	-	-	1	-	-	-	-	-	-	-	-
212058	Panel door rear left assembly .....	1	1	-	-	-	-	-	-	-	-	-
204445	Panel door rear left assembly .....	-	-	-	-	-	1	-	-	-	-	-
212425	Panel door rear left assembly .....	-	-	-	-	-	-	-	-	-	1	-
171001	Panel rear compartment door .....	-	-	-	-	-	-	1	-	-	-	-
204905	Panel rear deck and side assembly ....	-	-	-	-	-	-	-	-	1	-	-
187744	Panel rumble seat compartment door ...	-	-	-	-	-	-	-	1	1	-	-

**REAR COMPARTMENT**

173312	Rear compartment door assembly .....	-	-	-	-	-	-	1	-	-	-	-
122213	Rear compartment door brace assembly .	-	-	-	-	-	-	1	-	-	-	-
5676	Screw No. 10-32 x 3/8" rnd. hd. ..	-	-	-	-	-	-	1	-	-	-	-
5500	Lockwasher No. 10 std. ....	-	-	-	-	-	-	1	-	-	-	-
7003	Nut No. 10-32 .....	-	-	-	-	-	-	1	-	-	-	-
111687	Rear compartment door bumper .....	-	-	-	-	-	-	2	-	-	-	-
172133	Rear compartment door drain gutter assembly .....	-	-	-	-	-	-	1	-	-	-	-
158994	Rear compartment door hinge .....	-	-	-	-	-	-	2	-	-	-	-
5684	Bolt 1/4-28 x 1-7/8" carriage ....	-	-	-	-	-	-	4	-	-	-	-
5502	Lockwasher 1/4" std. ....	-	-	-	-	-	-	4	-	-	-	-
7004	Nut 1/4-28 .....	-	-	-	-	-	-	4	-	-	-	-
102590	Rear compartment light bulb 7 V. 3 CP G-6 single contact .....	-	-	-	-	-	-	1	-	-	-	-
107654	Rear compartment light disconnecter plug socket .....	-	-	-	-	-	-	1	-	-	-	-
176677	Rear compartment light to ground cable assembly .....	-	-	-	-	-	-	1	-	-	-	-
136593	Rear compartment light switch (2 point) .....	-	-	-	-	-	-	1	-	-	-	-

Piece No.	Name	No. Required										
		5633	5633A	633	634	635	636	637	638	639	643	647
33287	Rear compartment light switch cable terminal 13/64" eye .....	-	-	-	-	-	-	1	-	-	-	-
176282	Rear compartment door lock .....	-	-	-	-	-	-	1	-	-	-	-
176207	Rear compartment door lock handle (with key lock) .....	-	-	-	-	-	-	1	-	-	-	-
8018	Screw No. 8-32 x 7/8" oval hd. ...	-	-	-	-	-	-	1	-	-	-	-
184249	Rear compartment door lock handle screw washer .....	-	-	-	-	-	-	1	-	-	-	-
5581	Lockwasher 5/32" countersunk .....	-	-	-	-	-	-	1	-	-	-	-
176307	Rear compartment door lock striker ...	-	-	-	-	-	-	1	-	-	-	-
187828	Rear compartment door weatherstrip long .....	-	-	-	-	-	-	2	-	-	-	-
187829	Rear compartment door weatherstrip short .....	-	-	-	-	-	-	2	-	-	-	-

### REAR QUARTER LIGHT

211215	Rear quarter light .....	2	2	2	2	2	2	2	2	-	-	-
5868	Screw No. 10-32 x 5/8" flat hd. ...	2	2	2	2	2	2	2	2	-	-	-
102590	Rear quarter light bulb 7 V. 3CP G-6 single contact .....	2	2	2	2	2	2	2	2	-	-	-
211216	Rear quarter light glass and rim .....	2	2	2	2	2	2	2	2	-	-	-
183836	Rear quarter light reflector .....	2	2	2	2	2	2	2	2	-	-	-
183843	Rear quarter light switch .....	1	1	1	1	1	1	1	1	-	-	-

### REAR SEAT

195248	Rear seat back spring left .....	-	-	-	-	-	-	1	-	-	-	-
206455	Rear seat back spring left .....	1	1	-	1	1	-	-	-	-	-	-
206119	Rear seat back spring left .....	-	-	1	-	-	-	-	-	-	-	-
195246	Rear seat back spring left .....	-	-	-	-	-	1	-	-	-	-	-
206454	Rear seat back spring right .....	1	1	-	1	1	-	-	-	-	-	-
206118	Rear seat back spring right .....	-	-	1	-	-	-	-	-	-	-	-
195245	Rear seat back spring right .....	-	-	-	-	-	1	-	-	-	-	-
195247	Rear seat back spring right .....	-	-	-	-	-	-	1	-	-	-	-

NOTE:--Always send samples of material when ordering cushion assemblies, as the assemblies are upholstered to match the body interior.

204801	Rear seat cushion assembly .....	-	-	-	1	1	-	-	-	-	-	-
204802	Rear seat cushion assembly .....	1	1	1	-	-	-	-	-	-	-	-
181141	Rear seat cushion dowel female .....	2	2	2	2	2	2	2	-	-	-	-
204803	Rear seat cushion assembly .....	-	-	-	-	-	1	-	-	-	-	-
204804	Rear seat cushion assembly .....	-	-	-	-	-	-	1	-	-	-	-
181480	Rear seat cushion dowel male assembly.	-	-	-	-	-	-	2	-	-	-	-
181036	Rear seat cushion dowel male .....	-	-	-	-	-	2	-	-	-	-	-
187309	Rear seat cushion dowel male .....	2	2	2	2	2	-	-	-	-	-	-
3877	Washer 3/8" "N" std. ....	2	2	2	2	2	2	-	-	-	-	-
187522	Rear seat cushion spring .....	-	-	-	1	1	-	-	-	-	-	-
204221	Rear seat cushion spring .....	1	1	1	-	-	-	-	-	-	-	-
193374	Rear seat cushion spring .....	-	-	-	-	-	-	1	-	-	-	-
204234	Rear seat cushion spring .....	-	-	-	-	-	1	-	-	-	-	-

Piece No.	Name	No. Required										
		5633	5633A	633	634	635	636	637	638	639	643	647
<b>REAR VIEW MIRROR</b>												
193462	Rear view mirror assembly .....	-	-	-	-	-	-	-	-	1	1	1
212283	Rear view mirror assembly (7" x 2-1/2") .....	1	1	1	1	1	1	1	1	-	-	-
204904	Rear view mirror assembly (7-1/2" x 2-3/4") .....	-	-	1	1	1	1	1	1	-	-	-
5631	Screw No. 10-32 x 1/4" rnd. ....	-	-	-	-	-	-	-	-	2	2	2
5497	Screw No. 10-32 x 1/2" oval hd. ..	2	2	2	2	2	2	2	2	-	-	-
191368	Rear view mirror glass .....	-	-	-	-	-	-	-	-	1	-	-
212433	Rear view mirror glass (7-1/2" x 2-3/4") .....	-	-	1	1	1	1	1	1	-	-	-
<b>ROBE RAIL</b>												
204998	Robe rail assembly .....	-	-	1	-	-	1	-	-	-	1	-
204999	Robe rail assembly .....	1	1	-	1	1	-	-	-	-	-	-
<b>RUMBLE SEAT</b>												
193069	Rumble seat back spring .....	-	-	-	-	-	-	-	1	1	-	-
157018	Rumble seat compartment door bumper ..	-	-	-	-	-	-	-	2	2	-	-
187730	Rumble seat compartment door hinge right .....	-	-	-	-	-	-	-	1	1	-	-
187729	Rumble seat compartment door hinge left .....	-	-	-	-	-	-	-	1	1	-	-
7604	Bolt 1/4-28 x 1-5/8" carriage ....	-	-	-	-	-	-	-	6	6	-	-
7004	Nut 1/4-28 .....	-	-	-	-	-	-	-	6	6	-	-
5502	Lockwasher 1/4" std. ....	-	-	-	-	-	-	-	6	6	-	-
187727	Rumble seat compartment door hinge bracket right .....	-	-	-	-	-	-	-	1	1	-	-
187728	Rumble seat compartment door hinge bracket left .....	-	-	-	-	-	-	-	1	1	-	-
7613	Bolt 1/4-28 x 1-3/4" carriage ....	-	-	-	-	-	-	-	4	4	-	-
5502	Lockwasher 1/4" std. ....	-	-	-	-	-	-	-	4	4	-	-
7004	Nut 1/4-28 .....	-	-	-	-	-	-	-	4	4	-	-
8222	Screw 3/8-24 x 1" flat hd. ....	-	-	-	-	-	-	-	4	4	-	-
5506	Lockwasher 3/8" .....	-	-	-	-	-	-	-	4	4	-	-
7006	Nut 3/8-24 .....	-	-	-	-	-	-	-	4	4	-	-
196243	Rumble seat compartment door operating spring .....	-	-	-	-	-	-	-	2	2	-	-
157584	Rumble seat compartment door operating bolt .....	-	-	-	-	-	-	-	2	2	-	-
7104	Nut 1/4-28 castle .....	-	-	-	-	-	-	-	2	2	-	-
4280	Cotter pin 1/16 x 1/2" .....	-	-	-	-	-	-	-	2	2	-	-
157585	Rumble seat compartment door operating spring washer .....	-	-	-	-	-	-	-	2	2	-	-
127501	Rumble seat compartment door hinge bushing .....	-	-	-	-	-	-	-	2	2	-	-
127498	Rumble seat compartment door hinge screw .....	-	-	-	-	-	-	-	2	2	-	-
3884	Washer 1/2" "N" std. ....	-	-	-	-	-	-	-	2	2	-	-
5510	Lockwasher 1/2" std. ....	-	-	-	-	-	-	-	2	2	-	-
157625	Rumble seat compartment door lock striker .....	-	-	-	-	-	-	-	1	1	-	-
187773	Rumble seat compartment drain gutter assembly .....	-	-	-	-	-	-	-	1	1	-	-
102590	Rumble seat compartment light bulb 7 V 3 CP G-6 single contact .....	-	-	-	-	-	-	-	1	1	-	-

Piece No.	Name	No. Required											
		5633	5633A	633	634	635	636	637	638	639	643	647	
107654	Rumble seat compartment light dis- connector plug socket .....	-	-	-	-	-	-	-	-	1	1	-	-
176683	Rumble seat compartment light to ground cable assembly .....	-	-	-	-	-	-	-	-	-	1	-	-
176077	Rumble seat compartment light to instrument board cigar lighter cable assembly .....	-	-	-	-	-	-	-	-	-	1	-	-
136593	Rumble seat compartment light switch (2 point) .....	-	-	-	-	-	-	-	-	1	1	-	-
204197	Rumble seat cushion assembly (Furnish sample of material) .....	-	-	-	-	-	-	-	-	1	1	-	-
181141	Rumble seat cushion dowel female .....	-	-	-	-	-	-	-	-	2	2	-	-
187309	Rumble seat cushion dowel male .....	-	-	-	-	-	-	-	-	2	2	-	-
204264	Rumble seat cushion spring .....	-	-	-	-	-	-	-	-	1	1	-	-
204552	Rumble seat door lock assembly .....	-	-	-	-	-	-	-	-	-	1	-	-
148338	Rumble seat door lock .....	-	-	-	-	-	-	-	-	1	-	-	-
193062	Rumble seat door lock operating cable assembly .....	-	-	-	-	-	-	-	-	-	1	-	-
7513	Yoke end adj. 3/16" .....	-	-	-	-	-	-	-	-	-	1	-	-
7523	Yoke end pin 3/16" .....	-	-	-	-	-	-	-	-	-	1	-	-
3906	Washer 3/16" "Y" std. ....	-	-	-	-	-	-	-	-	-	2	-	-
4690	Pin 1/16 x 3/8" spring cotter ....	-	-	-	-	-	-	-	-	-	1	-	-
195687	Rumble seat door lock operating cable assembly clip .....	-	-	-	-	-	-	-	-	-	3	-	-
8207	Rumble seat door lock operating cable assembly clip screw No. 10-32 x 3/4" flat hd. ....	-	-	-	-	-	-	-	-	-	1	-	-
5500	Lockwasher No. 10 std. ....	-	-	-	-	-	-	-	-	-	1	-	-
7003	Nut No. 10-32 .....	-	-	-	-	-	-	-	-	-	1	-	-
193063	Rumble seat door lock operating handle .....	-	-	-	-	-	-	-	-	-	1	-	-
148339	Rumble seat door lock operating lever.	-	-	-	-	-	-	-	-	1	-	-	-
187888	Rumble seat door lock operating rod assembly .....	-	-	-	-	-	-	-	-	1	-	-	-
7513	Yoke end adj. 3/16" .....	-	-	-	-	-	-	-	-	1	-	-	-
7003	Nut No. 10-32 .....	-	-	-	-	-	-	-	-	1	-	-	-
7523	Yoke end pin 3/16" .....	-	-	-	-	-	-	-	-	3	-	-	-
3906	washer 3/16" "Y" std. ....	-	-	-	-	-	-	-	-	4	-	-	-
4690	Pin cotter spring 1/16 x 3/8" ....	-	-	-	-	-	-	-	-	3	-	-	-
206514	Rumble seat step lower assembly (Used with rear wheel carrier) .....	-	-	-	-	-	-	-	-	1	1	-	-
211879	Rumble seat step lower assembly (Used with side wheel carrier) .....	-	-	-	-	-	-	-	-	1	1	-	-
175144	Rumble seat step lower clamp plate ...	-	-	-	-	-	-	-	-	2	2	-	-
7859	Screw 1/4-28 x 1-1/2" hex. hd. ...	-	-	-	-	-	-	-	-	2	2	-	-
7842	Screw 1/4-28 x 1-1/4" hex. hd. ...	-	-	-	-	-	-	-	-	2	2	-	-
5502	Lockwasher 1/4" std. ....	-	-	-	-	-	-	-	-	4	4	-	-
7004	Nut 1/4-28 .....	-	-	-	-	-	-	-	-	4	4	-	-
206462	Rumble seat step lower linoleum (Used with rear wheel carrier) .....	-	-	-	-	-	-	-	-	1	1	-	-
211875	Rumble seat step lower linoleum (Used with side wheel carrier) .....	-	-	-	-	-	-	-	-	1	1	-	-
206729	Rumble seat step upper assembly .....	-	-	-	-	-	-	-	-	1	1	-	-
6116	Stud 3/8" std. ....	-	-	-	-	-	-	-	-	3	3	-	-
114055	Washer 25/64 x 3/4 x 5/32" plain .	-	-	-	-	-	-	-	-	3	3	-	-
5506	Lockwasher 3/8" std. ....	-	-	-	-	-	-	-	-	3	3	-	-
7006	Nut 3/8-24 .....	-	-	-	-	-	-	-	-	3	3	-	-
7811	Screw 5/16-24 x 1-3/8" hex. hd. ..	-	-	-	-	-	-	-	-	2	2	-	-
5504	Lockwasher 5/16" std. ....	-	-	-	-	-	-	-	-	2	2	-	-
179123	Rumble seat step upper liner .....	-	-	-	-	-	-	-	-	1	1	-	-
204938	Rumble seat step upper linoleum .....	-	-	-	-	-	-	-	-	1	1	-	-



193063



127498

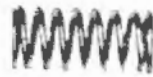

196243



157585



157584



175144



148339



107654



136593



204552



148338



157625



157018



11<sup>TH</sup> SERIES ONLY



206514



11<sup>TH</sup> SERIES ONLY



206729



206696



11<sup>TH</sup> SERIES ONLY



211879



179123



187729-187730



206698



187727-187728



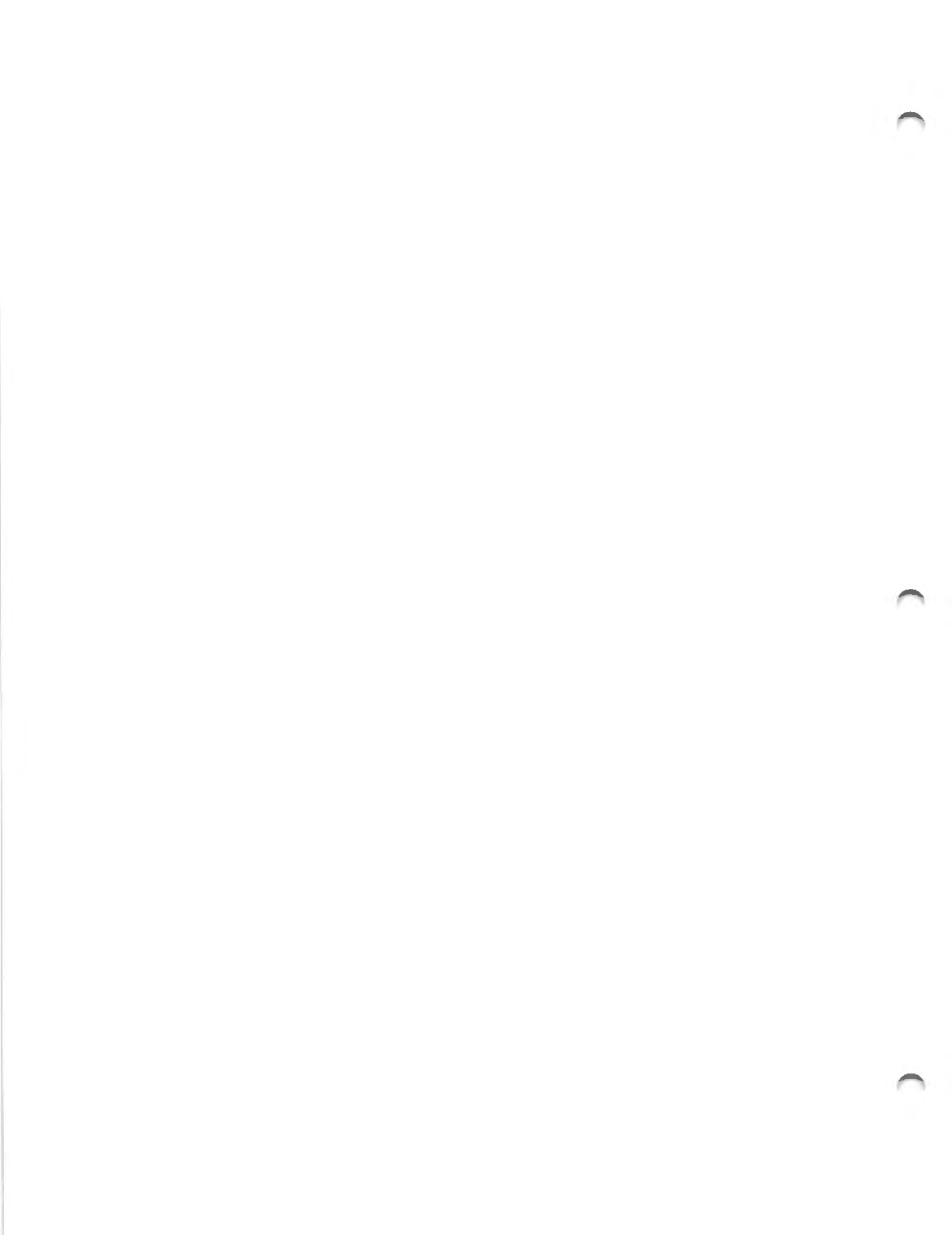

Piece No.	Name	No. Required										
		5633	5633A	633	634	635	636	637	638	639	643	647
206696	Rumble seat step upper bracket .....	-	-	-	-	-	-	-	1	1	-	-
206698	Rumble seat step upper bracket gasket.	-	-	-	-	-	-	-	1	1	-	-

SMOKING CASE

199896	Smoking case ash receiver-left rear ..	-	-	1	-	-	-	-	-	-	-	-
199896	Smoking case ash receiver-right front.	-	-	1	-	-	-	-	-	-	-	-
199897	Smoking case ash receiver-left front .	-	-	1	-	-	-	-	-	-	-	-
199897	Smoking case ash receiver-right rear .	-	-	1	-	-	-	-	-	-	-	-
212159	Smoking case ash receiver-right (5" long) .....	-	-	-	1	1	-	-	-	-	-	-
199910	Smoking case ash receiver-right front (2" long) .....	-	-	-	1	1	-	1	-	-	-	-
212094	Smoking case ash receiver-right .....	2	2	-	-	-	-	-	-	-	-	-
199909	Smoking case ash receiver-right rear (2" long) .....	-	-	-	1	1	-	1	-	-	-	-
212158	Smoking case ash receiver-left (5" long) .....	-	-	-	1	1	-	-	-	-	-	-
199909	Smoking case ash receiver-left front (2" long) .....	-	-	-	1	1	-	1	-	-	-	-
212095	Smoking case ash receiver-left .....	2	2	-	-	-	-	-	-	-	-	-
199910	Smoking case ash receiver-left rear (2" long) .....	-	-	-	1	1	-	1	-	-	-	-
199911	Smoking case ash receiver-right .....	-	-	-	-	-	1	-	-	-	-	-
199912	Smoking case ash receiver-left .....	-	-	-	-	-	1	-	-	-	-	-
199923	Smoking case cigar lighter .....	2	2	2	2	2	2	2	-	-	1	2
199932	Smoking case cigar lighter complete ..	2	2	2	2	2	2	2	-	-	1	2
199925	Smoking case cigar lighter complete ..	-	-	-	-	-	2	-	-	-	-	-
182377	Smoking case cigar lighter tip .....	2	2	2	2	2	2	2	-	-	1	2
199921	Smoking case clock .....	-	-	-	1	1	-	1	-	-	-	-
204996	Smoking case complete .....	-	-	2	-	-	-	-	-	-	1	2
212038	Smoking case complete .....	2	-	-	-	-	-	-	-	-	-	-
135022	Smoking case dove-tail female .....	-	-	4	-	-	-	-	-	-	-	-

SUN VISOR

179077	Sun visor hinge .....	2	2	2	2	2	2	2	2	-	-	-
206886	Sun visor panel trimmed assembly right (Furnish sample of material) .	1	1	1	1	1	1	1	1	-	-	-
206887	Sun visor panel trimmed assembly left (Furnish sample of material) ..	1	1	1	1	1	1	1	1	-	-	-

TOGGLE GRIP

206011	Toggle grip (Specify color of uphol- stering material) .....	2	2	2	2	2	2	2	2	-	-	-
206012	Toggle grip loop .....	2	2	2	2	2	2	2	2	-	-	-
206013	Toggle grip loop ferrule .....	2	2	2	2	2	2	2	2	-	-	-

TONNEAU LIGHT

180645	Tonneau light assembly .....	-	-	-	-	-	-	-	-	-	2	-
102590	Tonneau light bulb .....	-	-	-	-	-	-	-	-	-	2	-
180646	Tonneau light-glass and rim .....	-	-	-	-	-	-	-	-	-	2	-
180647	Tonneau light reflector .....	-	-	-	-	-	-	-	-	-	2	-
185331	Tonneau light switch .....	-	-	-	-	-	-	-	-	-	2	-
127502	Tonneau light switch plunger plate ...	-	-	-	-	-	-	-	-	-	2	-

Piece No.	Name	No. Required										
		3633	3633A	633	634	635	636	637	638	639	643	647
<b>TOP</b>												
212434	Top assembly .....	-	-	-	-	-	-	-	-	1	-	-
193092	Top center bow .....	-	-	-	-	-	-	-	-	1	-	-
193418	Top envelope assembly .....	-	-	-	-	-	-	-	-	1	-	-
193181	Top folding pillar bumper .....	-	-	-	-	-	-	-	-	2	-	-
193082	Top folding pillar hinge .....	-	-	-	-	-	-	-	-	2	-	-
8234	Screw 1/4-28 x 1-3/4" flat hd. ....	-	-	-	-	-	-	-	-	6	-	-
62065	Washer 1/4" special .....	-	-	-	-	-	-	-	-	6	-	-
5502	Lockwasher 1/4" std. ....	-	-	-	-	-	-	-	-	6	-	-
7004	Nut 1/4-28 .....	-	-	-	-	-	-	-	-	6	-	-
193148	Top folding pillar hinge bracket- right .....	-	-	-	-	-	-	-	-	1	-	-
193147	Top folding pillar hinge bracket-left.	-	-	-	-	-	-	-	-	1	-	-
7613	Bolt 1/4-28 x 1-3/4" carriage ....	-	-	-	-	-	-	-	-	8	-	-
5502	Lockwasher 1/4" std. ....	-	-	-	-	-	-	-	-	8	-	-
7004	Nut 1/4-28 .....	-	-	-	-	-	-	-	-	8	-	-
193162	Top folding pillar hinge pin .....	-	-	-	-	-	-	-	-	2	-	-
5504	Lockwasher 5/16" std. ....	-	-	-	-	-	-	-	-	2	-	-
193429	Top folding pillar and side rail assembly .....	-	-	-	-	-	-	-	-	1	-	-
195794	Top hold down strap assembly-center ..	-	-	-	-	-	-	-	-	2	-	-
195795	Top hold down strap assembly .....	-	-	-	-	-	-	-	-	-	-	2
193437	Top to front pillar weatherstrip right .....	-	-	-	-	-	-	-	-	1	1	1
193438	Top to front pillar weatherstrip left.	-	-	-	-	-	-	-	-	1	1	1
195700	Top main bow .....	-	-	-	-	-	-	-	-	-	-	1
212396	Top main bow hinge assembly-right ....	-	-	-	-	-	-	-	-	-	-	1
212397	Top main bow hinge assembly-left ....	-	-	-	-	-	-	-	-	-	-	1
212398	Top main bow upper hinge assembly- right .....	-	-	-	-	-	-	-	-	-	1	-
212399	Top main bow upper hinge assembly-left	-	-	-	-	-	-	-	-	-	1	-
212408	Top prop assembly .....	-	-	-	-	-	-	-	-	-	2	-
193629	Top prop-right assembly .....	-	-	-	-	-	-	-	-	1	-	-
212409	Top prop-right assembly .....	-	-	-	-	-	-	-	-	-	-	1
212410	Top prop-left assembly .....	-	-	-	-	-	-	-	-	-	-	1
193630	Top prop-left assembly .....	-	-	-	-	-	-	-	-	1	-	-
193150	Top prop bracket-upper right .....	-	-	-	-	-	-	-	-	1	-	-
193149	Top prop bracket-upper left .....	-	-	-	-	-	-	-	-	1	-	-
193224	Top prop pivot stud .....	-	-	-	-	-	-	-	-	4	-	-
193060	Top prop roller .....	-	-	-	-	-	-	-	-	2	-	-
193061	Top prop roller screw .....	-	-	-	-	-	-	-	-	2	-	-
5935	Lockwasher No. 10 Shakeproof .....	-	-	-	-	-	-	-	-	2	-	-
212157	Top rear bow .....	-	-	-	-	-	-	-	-	1	-	-
212380	Top rear bow .....	-	-	-	-	-	-	-	-	-	1	-
212381	Top rear bow .....	-	-	-	-	-	-	-	-	-	-	1
193417	Top rear bow and slat assembly .....	-	-	-	-	-	-	-	-	1	-	-
142849	Top rear bow slat iron spacer .....	-	-	-	-	-	-	-	-	2	-	-
184505	Top rear bow slat tee nut .....	-	-	-	-	-	-	-	-	2	-	-
195270	Top rear curtain window glass .....	-	-	-	-	-	-	-	-	1	-	-
195744	Top rear curtain window glass .....	-	-	-	-	-	-	-	-	-	1	1
193249	Top rear curtain window .....	-	-	-	-	-	-	-	-	1	-	-
195732	Top rear curtain window frame .....	-	-	-	-	-	-	-	-	-	1	1
193056	Top side rail center hinge assembly ..	-	-	-	-	-	-	-	-	2	-	-
212388	Top side rail center hinge assembly right .....	-	-	-	-	-	-	-	-	-	1	-
212389	Top side rail center hinge assembly left .....	-	-	-	-	-	-	-	-	-	1	-
193083	Top side rail center hinge joint clamp	-	-	-	-	-	-	-	-	2	-	-
193084	Top side rail center hinge joint clamp plate .....	-	-	-	-	-	-	-	-	2	-	-

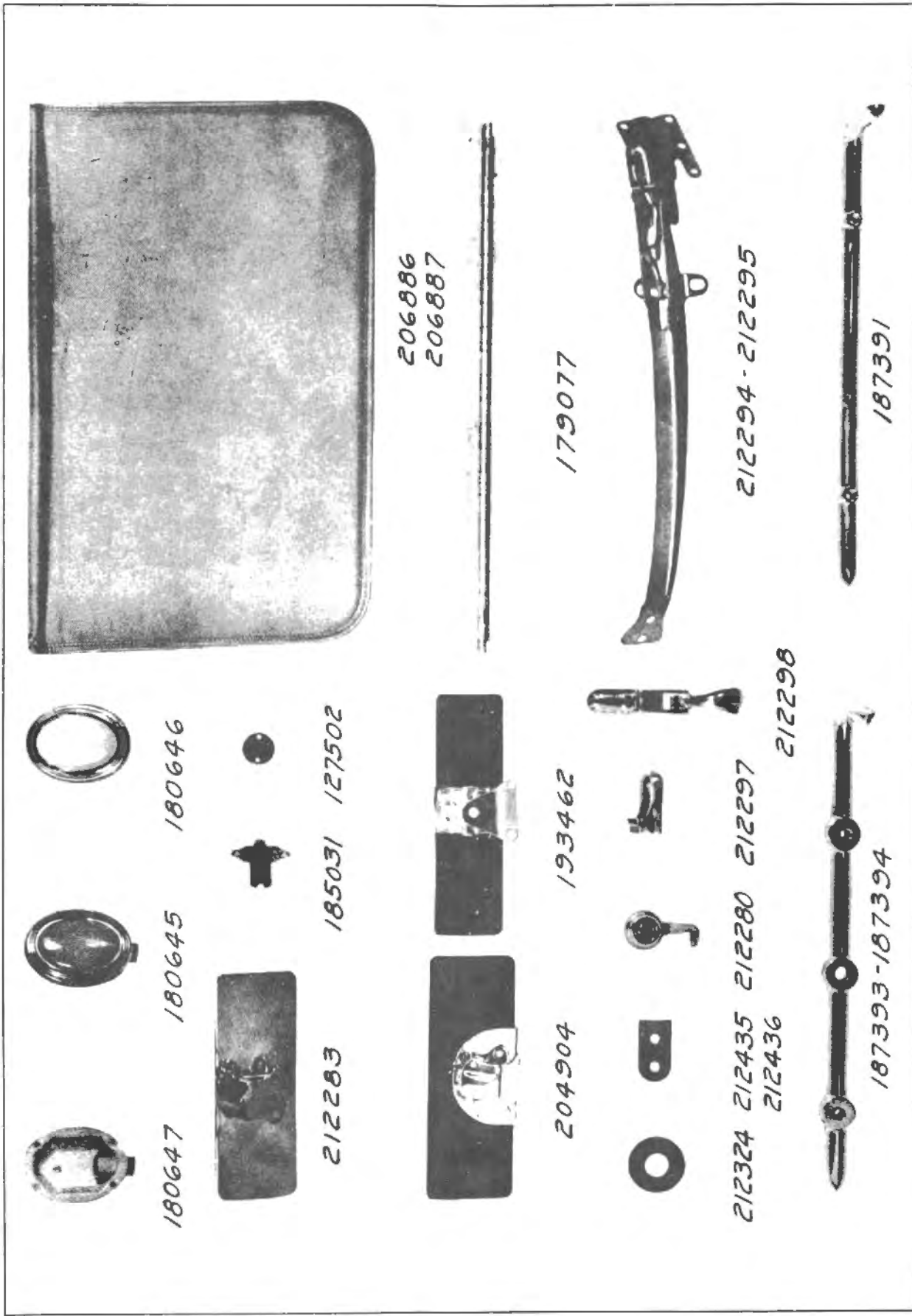

206886  
206887



179077



212294 - 212295

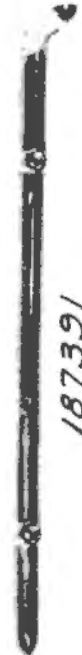

187391



180646



180645



180647



212283



185031 127502



193462



204904



212298



212297



212280



212436



212435



187393 - 187394

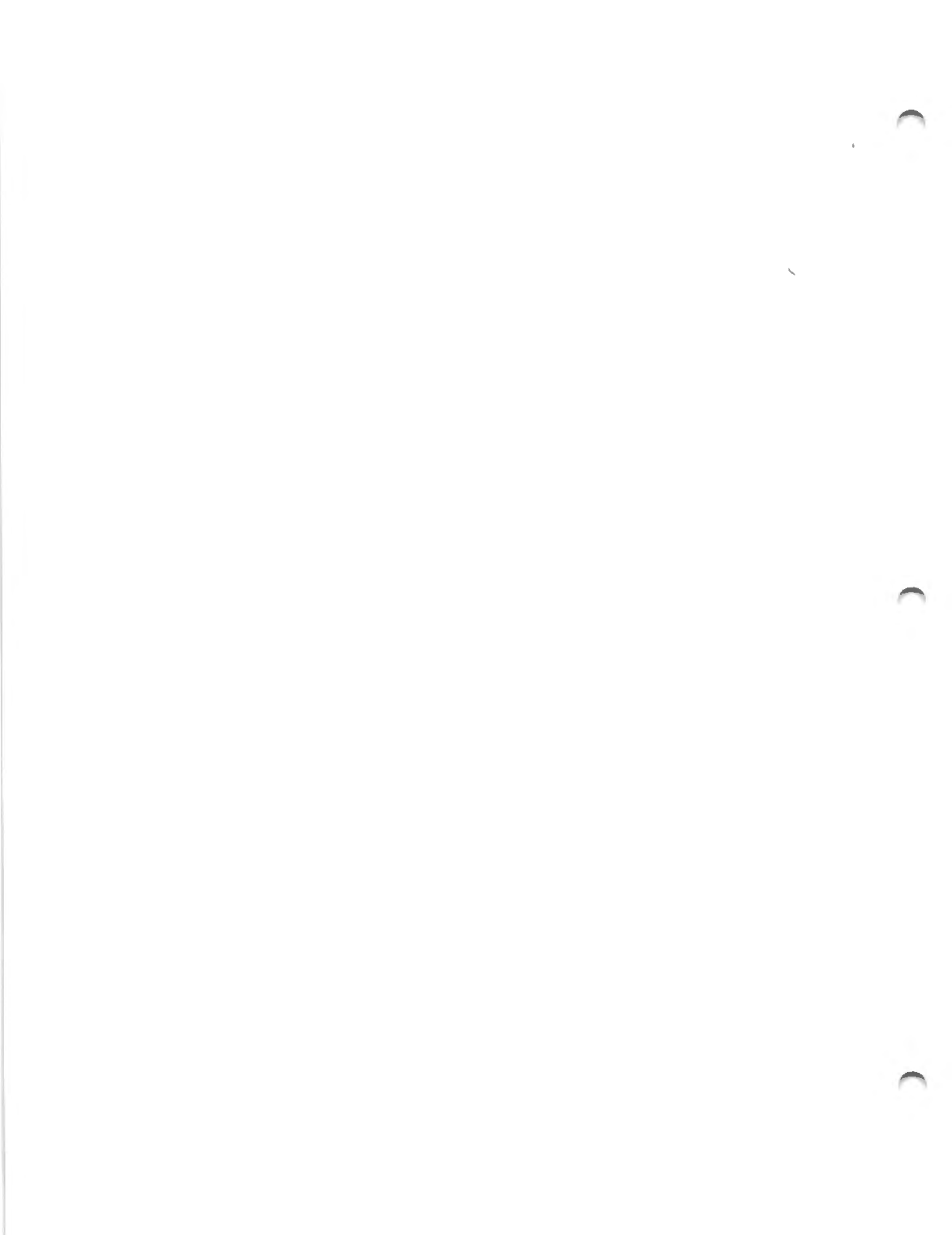

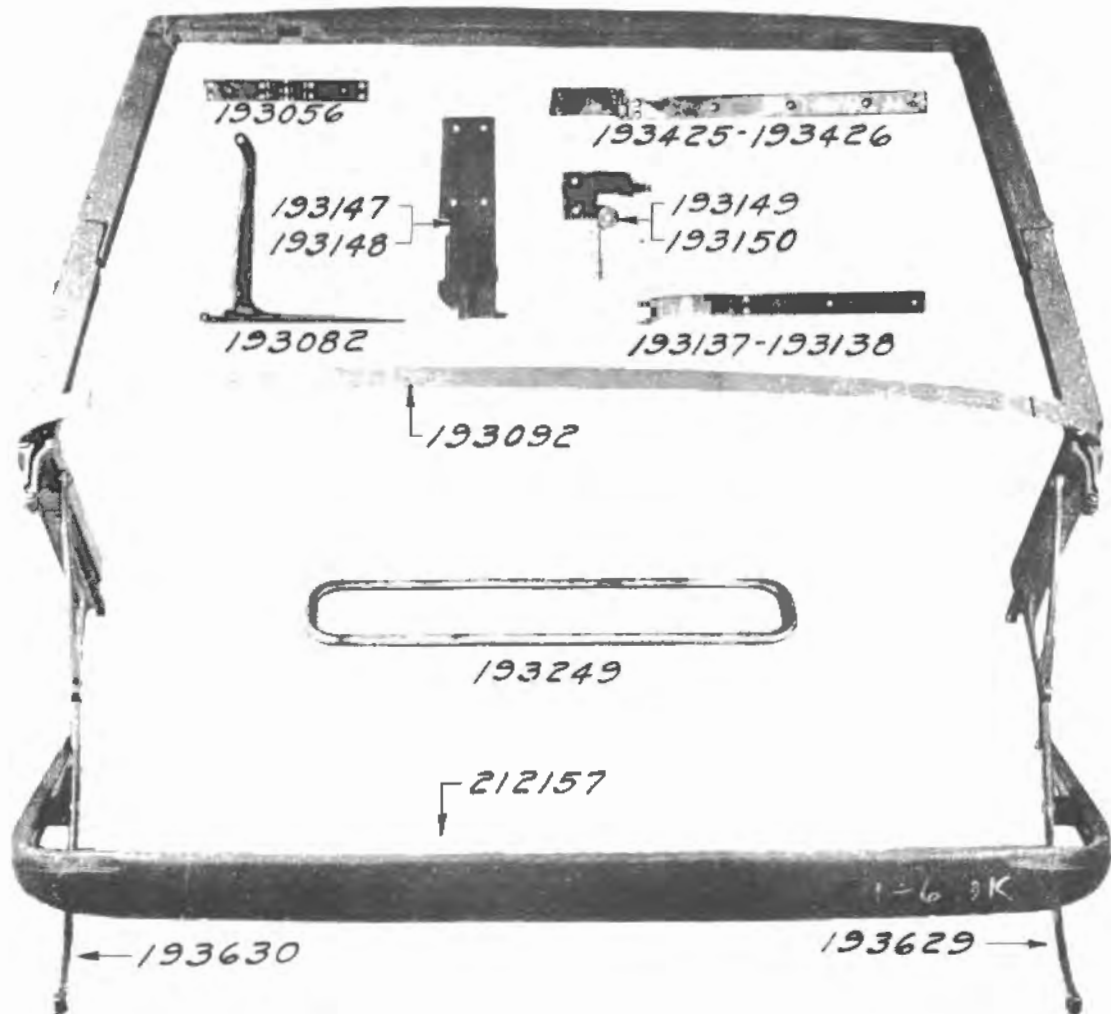





Piece No.	Name	No. Required											
		5633	5653A	633	634	635	636	637	638	639	643	647	
5954	Screw No. 10-32 x 5/16" oval hd. .	-	-	-	-	-	-	-	-	-	4	-	-
193138	Top side rail to folding pillar hinge right .....	-	-	-	-	-	-	-	-	-	1	-	-
193137	Top side rail to folding pillar hinge left .....	-	-	-	-	-	-	-	-	-	1	-	-
156406	Top side rail to folding pillar hinge pin screw 5/16-24 x 1-3/8" fill. hd.	-	-	-	-	-	-	-	-	-	2	-	-
212394	Top side rail to header hinge-right ..	-	-	-	-	-	-	-	-	-	-	-	1
212395	Top side rail to header hinge-left ...	-	-	-	-	-	-	-	-	-	-	-	1
193425	Top side rail to header hinge-right assembly .....	-	-	-	-	-	-	-	-	-	1	-	-
212392	Top side rail to header hinge right assembly .....	-	-	-	-	-	-	-	-	-	-	1	-
193426	Top side rail to header hinge left assembly .....	-	-	-	-	-	-	-	-	-	1	-	-
212393	Top side rail to header hinge left assembly .....	-	-	-	-	-	-	-	-	-	-	1	-
193184	Top side rail to header hinge pin ....	-	-	-	-	-	-	-	-	-	2	-	-
195748	Top side rail locking device handle- right .....	-	-	-	-	-	-	-	-	-	-	-	1
195749	Top side rail locking device handle- left .....	-	-	-	-	-	-	-	-	-	-	-	1
212400	Top side roof rail rear hinge assembly-right .....	-	-	-	-	-	-	-	-	-	-	1	-
212401	Top side roof rail rear hinge assembly-left .....	-	-	-	-	-	-	-	-	-	-	1	-
193180	Top to windshield clamp assembly .....	-	-	-	-	-	-	-	-	-	2	-	-
195720	Top to windshield clamp assembly .....	-	-	-	-	-	-	-	-	-	-	-	2
193142	Top to windshield clamp bracket .....	-	-	-	-	-	-	-	-	-	2	-	-
195713	Top to windshield clamp bracket .....	-	-	-	-	-	-	-	-	-	-	-	2
195685	Top to windshield clamp bracket screw.	-	-	-	-	-	-	-	-	-	4	-	-
193154	Top to windshield clamp catch .....	-	-	-	-	-	-	-	-	-	2	2	-
212432	Top to windshield clamp catch .....	-	-	-	-	-	-	-	-	-	-	-	2
5954	Screw No. 10-32 x 5/16" oval hd. .	-	-	-	-	-	-	-	-	-	4	4	-
193436	Top to windshield header weatherstrip.	-	-	-	-	-	-	-	-	-	1	1	1

## TRUNK AND TRUNK BARS

187391	Rear platform trunk bar center .....	-	-	-	-	-	3	-	-	-	-	-	-
187394	Rear platform trunk bar outside right.	-	-	-	-	-	1	-	-	-	-	-	-
187393	Rear platform trunk bar outside left .	-	-	-	-	-	1	-	-	-	-	-	-
212427	Trunk assembly .....	-	-	-	-	-	-	-	-	-	-	-	1
212325	Trunk assembly .....	-	-	-	-	-	1	-	-	-	-	-	-
5286	Screw No. 10-32 x 1" rnd. hd. ....	-	-	-	-	-	6	-	-	-	-	-	-
3867	Washer 3/16" special .....	-	-	-	-	-	6	-	-	-	-	-	-
5500	Lockwasher 3/16" .....	-	-	-	-	-	6	-	-	-	-	-	-
7003	Nut No. 10-32 .....	-	-	-	-	-	6	-	-	-	-	-	-
5684	Bolt 1/4-28 x 1-7/8" common carriage .....	-	-	-	-	-	1	-	-	-	-	-	-
7610	Bolt 1/4-28 x 2-1/8" common carriage .....	-	-	-	-	-	2	-	-	-	-	-	-
7620	Bolt 1/4-28 x 2-3/4" common carriage .....	-	-	-	-	-	2	-	-	-	-	-	-
5817	Lockwasher 1/4" Shakeproof (Woodtype) .....	-	-	-	-	-	5	-	-	-	-	-	-
7004	Nut 1/4-28 .....	-	-	-	-	-	5	-	-	-	-	-	-
212310	Trunk to body liner .....	-	-	-	-	-	1	-	-	-	-	-	-
29664	Tacks 4 oz. trimmers .....	-	-	-	-	-	x	-	-	-	-	-	-
212280	Trunk key lock .....	-	-	-	-	-	1	-	-	-	-	-	-

Piece No.	Name	No. Required													
		5633	5633A	633	634	635	636	637	638	639	643	647			
212411	Trunk key lock .....	-	-	-	-	-	-	-	-	-	-	-	-	-	2
212298	Trunk lid clamp .....	-	-	-	-	-	2	-	-	-	-	-	-	-	-
212435	Trunk lid clamp liner .....	-	-	-	-	-	2	-	-	-	-	-	-	-	-
184249	Trunk lid clamp screw ferrule No. 8 ..	-	-	-	-	-	4	-	-	-	-	-	-	-	-
8018	Screw No. 8-32 x 7/16" oval hd. ..	-	-	-	-	-	4	-	-	-	-	-	-	-	-
5581	Trunk lid clamp lockwasher No. 8 .....	-	-	-	-	-	4	-	-	-	-	-	-	-	-
212297	Trunk lid clamp bracket .....	-	-	-	-	-	2	-	-	-	-	-	-	-	-
212299	Trunk lid clamp bracket washer .....	-	-	-	-	-	4	-	-	-	-	-	-	-	-
184249	Trunk lid clamp bracket screw ferrule No. 8 .....	-	-	-	-	-	4	-	-	-	-	-	-	-	-
5312	Screw No. 8-32 x 3/8" oval hd. ....	-	-	-	-	-	4	-	-	-	-	-	-	-	-
5581	Lockwasher No. 8 .....	-	-	-	-	-	4	-	-	-	-	-	-	-	-
212438	Trunk lid clamp bracket liner .....	-	-	-	-	-	2	-	-	-	-	-	-	-	-
212295	Trunk lid hinge-right .....	-	-	-	-	-	1	-	-	-	-	-	-	-	-
212294	Trunk lid hinge-left .....	-	-	-	-	-	1	-	-	-	-	-	-	-	-
195718	Trunk lid hinge assembly-right .....	-	-	-	-	-	-	-	-	-	-	-	-	-	1
195719	Trunk lid hinge assembly-left .....	-	-	-	-	-	-	-	-	-	-	-	-	-	1
212299	Trunk lid hinge washer 1/4" .....	-	-	-	-	-	2	-	-	-	-	-	-	-	-
5396	Trunk lid hinge lockwasher 1/4" .....	-	-	-	-	-	4	-	-	-	-	-	-	-	-
7004	Nut 1/4-28 .....	-	-	-	-	-	4	-	-	-	-	-	-	-	-
6056	Lockwasher No. 10 .....	-	-	-	-	-	12	-	-	-	-	-	-	-	-
5253	Screw No. 10-32 x 3/4" rnd. hd. ..	-	-	-	-	-	12	-	-	-	-	-	-	-	-
212304	Screw 1/4-28 x 9/16" spec. hd. ...	-	-	-	-	-	4	-	-	-	-	-	-	-	-
212281	Trunk lid weatherstrip .....	-	-	-	-	-	1	-	-	-	-	-	-	-	-
212324	Trunk rear wheel carrier brace grommet (Use only with rear wheel carrier) .	-	-	-	-	-	1	-	-	-	-	-	-	-	-

## VENTILATOR

206014	Ventilator complete .....	1	1	1	1	1	1	1	1	1	-	-	-	-	-
206015	Ventilator cover assembly .....	1	1	1	1	1	1	1	1	1	-	-	-	-	-
187098	Ventilator cover assembly .....	-	-	-	-	-	-	-	-	-	1	1	1	-	-
5569	Ventilator cover attaching screw No. 10-32 x 5/8" fill. hd. ....	4	4	4	4	4	4	4	4	4	-	-	-	-	-
5500	Lockwasher No. 10 std. ....	4	4	4	4	4	4	4	4	4	-	-	-	-	-
7003	Nut No. 10-32 .....	4	4	4	4	4	4	4	4	4	-	-	-	-	-
5471	Screw 1/4-28 x 3/4" hex. hd. ....	1	1	1	1	1	1	1	1	1	-	-	-	-	-
5873	Screw 1/4-28 x 9/16" hex. hd. ....	2	2	2	2	2	2	2	2	2	-	-	-	-	-
5502	Lockwasher 1/4" std. ....	3	3	3	3	3	3	3	3	3	-	-	-	-	-
7004	Nut 1/4-28 .....	3	3	3	3	3	3	3	3	3	-	-	-	-	-
137537	Ventilator cover hinge screw .....	-	-	-	-	-	-	-	-	-	2	2	2	-	-
204354	Ventilator cover hinge screw .....	2	2	2	2	2	2	2	2	2	-	-	-	-	-
3868	Washer 1/4" "N" std. ....	-	-	-	-	-	-	-	-	-	2	2	2	-	-
5500	Lockwasher No. 10 std. ....	2	2	2	2	2	2	2	2	2	-	2	2	-	-
7003	Nut No. 10-32 .....	2	2	2	2	2	2	2	2	2	-	2	2	-	-
7104	Nut 1/4-28 castle .....	-	-	-	-	-	-	-	-	-	2	2	2	-	-
4280	Pin 1/16 x 1/2" cotter .....	-	-	-	-	-	-	-	-	-	2	2	2	-	-
185776	Ventilator cover operating lever .....	-	-	-	-	-	-	-	-	-	1	1	1	-	-
7800	Screw 1/4-28 x 1" hex. hd. ....	-	-	-	-	-	-	-	-	-	2	2	2	-	-
5502	Lockwasher 1/4" std. ....	-	-	-	-	-	-	-	-	-	2	2	2	-	-
7004	Nut 1/4-28 .....	-	-	-	-	-	-	-	-	-	2	2	2	-	-
3868	Washer 1/4" "N" std. ....	-	-	-	-	-	-	-	-	-	2	2	2	-	-
118555	Ventilator cover operating lever pin .	-	-	-	-	-	-	-	-	-	1	1	1	-	-
118771	Ventilator operating pin roller .....	-	-	-	-	-	-	-	-	-	1	1	1	-	-
4280	Pin 1/16 x 1/2" cotter .....	-	-	-	-	-	-	-	-	-	1	1	1	-	-
206016	Ventilator cover operating lever and roller assembly .....	1	1	1	1	1	1	1	1	1	-	-	-	-	-
206086	Ventilator cover operating lever ratchet assembly .....	1	1	1	1	1	1	1	1	1	-	-	-	-	-

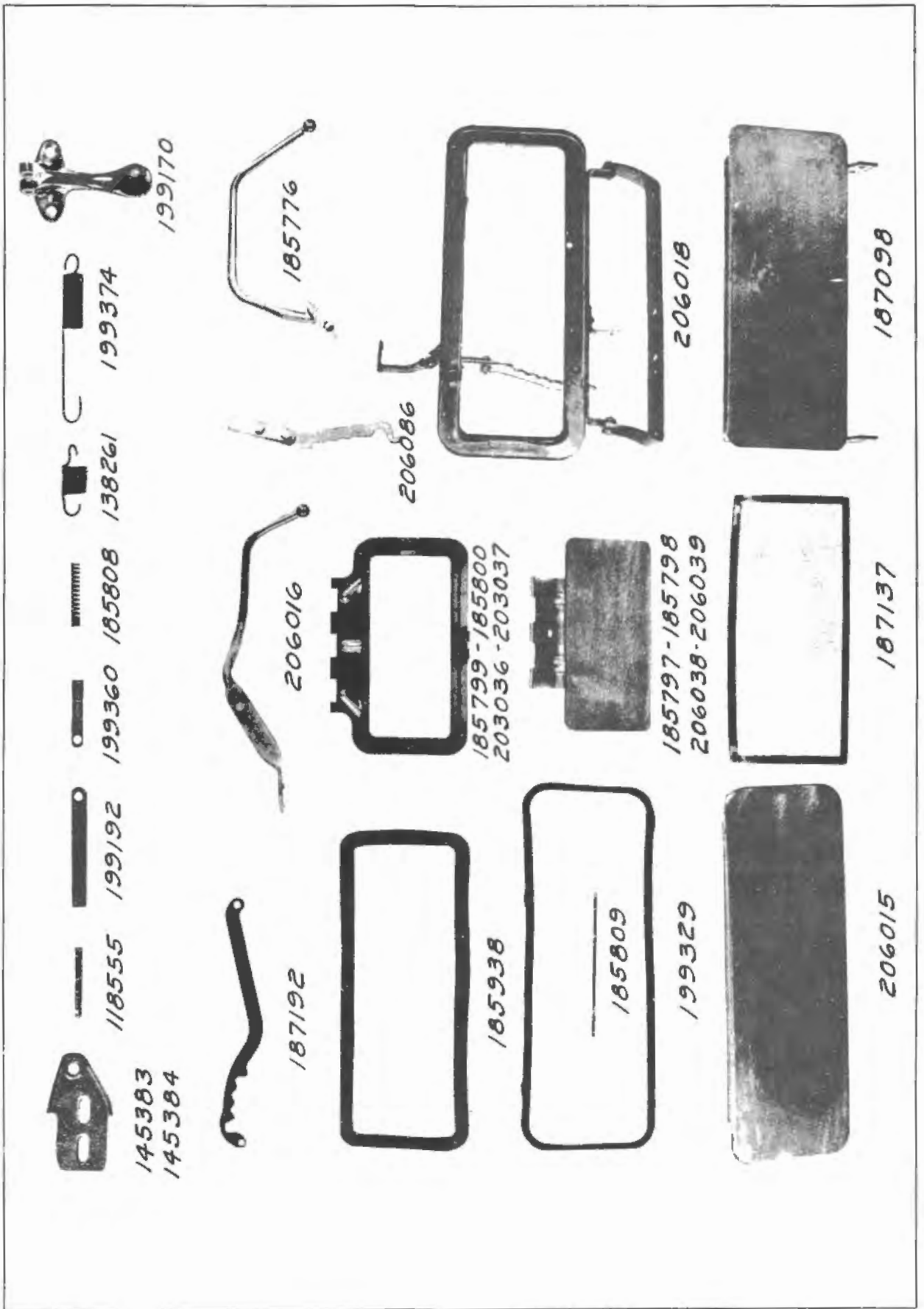

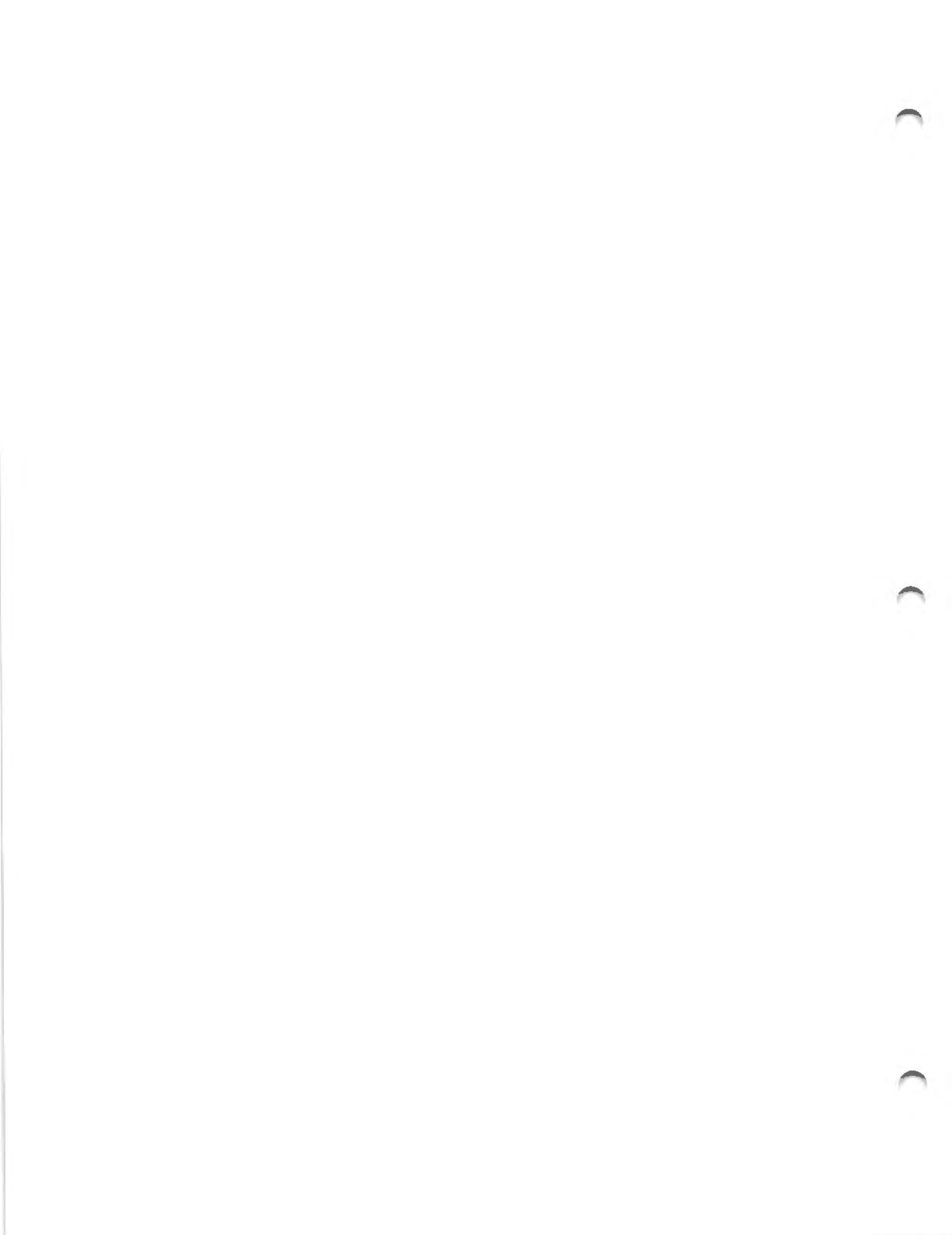

Piece No.	Name	No. Required											
		5633	5633A	633	634	635	636	637	638	639	643	647	
187192	Ventilator cover operating lever ratchet .....	-	-	-	-	-	-	-	-	-	1	1	1
5792	Ventilator cover operating lever ratchet yoke end pin 5/16" .....	1	1	1	1	1	1	1	1	1	1	1	1
4290	Pin 3/32 x 5/8" cotter .....	1	1	1	1	1	1	1	1	1	1	1	1
199374	Ventilator cover spring .....	1	1	1	1	1	1	1	1	-	-	-	-
138261	Ventilator cover spring .....	-	-	-	-	-	-	-	-	1	1	1	1
206018	Ventilator drain gutter assembly .....	1	1	1	1	1	1	1	1	-	-	-	-
5253	Ventilator drain gutter to dash screw No. 10-32 x 3/4" rnd. hd. mach. ....	1	1	1	1	1	1	1	1	-	-	-	-
5500	Lockwasher No. 10 std. ....	1	1	1	1	1	1	1	1	-	-	-	-
196493	Ventilator drain tube hose .....	2	2	2	2	2	2	2	2	-	-	-	-
5286	Ventilator drain tube hose clamp screw No. 10-32 x 1" rnd. hd. ....	2	2	2	2	2	2	2	2	-	-	-	-
5500	Lockwasher No. 10 std. ....	2	2	2	2	2	2	2	2	-	-	-	-
7003	Nut No. 10-32 .....	2	2	2	2	2	2	2	2	-	-	-	-
145383	Ventilator hinge adjusting plate assembly-left .....	-	-	-	-	-	-	-	-	1	1	1	1
145384	Ventilator hinge adjusting plate assembly-right .....	-	-	-	-	-	-	-	-	1	1	1	1
187137	Ventilator screen assembly .....	-	-	-	-	-	-	-	-	1	1	1	1
8011	Screw No. 8-32 x 7/16" oval hd. ..	-	-	-	-	-	-	-	-	6	6	6	6
3774	Lockwasher No. 8 std. ....	-	-	-	-	-	-	-	-	6	6	6	6
7002	Nut No. 8-32 .....	-	-	-	-	-	-	-	-	6	6	6	6
206036	Ventilator side door gutter and operating lever bracket assembly-right .....	1	1	1	1	1	1	1	1	-	-	-	-
185800	Ventilator side door gutter and operating lever bracket assembly-right .....	-	-	-	-	-	-	-	-	1	1	1	1
206037	Ventilator side door gutter and operating lever bracket assembly-left .....	1	1	1	1	1	1	1	1	-	-	-	-
185799	Ventilator side door gutter and operating lever bracket assembly-left .....	-	-	-	-	-	-	-	-	1	1	1	1
206038	Ventilator side door and hinge assembly-right .....	1	1	1	1	1	1	1	1	-	-	-	-
185798	Ventilator side door and hinge assembly-right .....	-	-	-	-	-	-	-	-	1	1	1	1
206039	Ventilator side door and hinge assembly-left .....	1	1	1	1	1	1	1	1	-	-	-	-
185797	Ventilator side door and hinge assembly-left .....	-	-	-	-	-	-	-	-	1	1	1	1
185893	Ventilator side door hinge bumper ....	2	2	2	2	2	2	2	2	2	2	2	2
185809	Ventilator side door hinge pin .....	2	2	2	2	2	2	2	2	2	2	2	2
4690	Pin spring cotter 1/16 x 3/8" ....	2	2	2	2	2	2	2	2	2	2	2	2
199170	Ventilator side door operating lever handle .....	2	2	2	2	2	2	2	2	2	2	2	2
5954	Screw No. 10-32 x 5/16" oval hd. ..	4	4	4	4	4	4	4	4	4	4	4	4
199360	Ventilator side door operating lever plunger .....	2	2	2	2	2	2	2	2	2	2	2	2
5346	Screw No. 10-32 x 7/8" rnd. hd. ..	2	2	2	2	2	2	2	2	2	2	2	2
5500	Lockwasher No. 10 .....	2	2	2	2	2	2	2	2	2	2	2	2
7003	Nut No. 10-32 .....	2	2	2	2	2	2	2	2	2	2	2	2
199192	Ventilator side door operating lever sleeve .....	2	2	2	2	2	2	2	2	2	2	2	2
5667	Screw No. 10-32 x 5/8" rnd. hd. ..	2	2	2	2	2	2	2	2	2	2	2	2
5500	Lockwasher No. 10 .....	2	2	2	2	2	2	2	2	2	2	2	2
7003	Nut No. 10-32 .....	2	2	2	2	2	2	2	2	2	2	2	2

Piece No.	Name	No. Required										
		5633	5633A	633	634	635	636	637	638	639	643	647
185808	Ventilator side door operating spring.	2	2	2	2	2	2	2	2	2	2	2
185814	Ventilator side weatherstrip .....	2	2	2	2	2	2	2	2	2	2	2
185938	Ventilator weatherstrip .....	-	-	-	-	-	-	-	-	1	1	1
199329	Ventilator weatherstrip .....	1	1	1	1	1	1	1	1	-	-	-
WINDOW												
178949	Window anti-rattler .....	2	2	2	2	2	2	-	-	-	-	-
187982	Window anti-rattler short .....	-	-	-	-	-	-	-	-	2	8	4
199371	Window anti-rattler long .....	-	-	-	-	-	-	-	-	2	-	-
178928	Window anti-rattler partition-rear ...	-	-	-	-	1	-	-	-	-	-	-
204961	Window curtain rear assembly (Specify set number) .....	-	1	-	-	-	-	-	-	-	-	-
212096	Window curtain rear assembly (Specify set number) .....	1	-	-	-	-	-	-	-	-	-	-
204962	Window curtain rear assembly (Specify set number) .....	-	-	1	1	1	1	1	1	-	-	-
185305	Window curtain side left assembly (Specify set number) .....	-	-	1	-	-	-	-	-	-	-	-
204600	Window curtain side right assembly (Specify set number) .....	-	-	1	-	-	-	-	-	-	-	-
185306	Window curtain side left assembly (Specify set number) .....	-	-	-	1	1	-	-	-	-	-	-
212205	Window curtain side left assembly (Specify set number) .....	-	1	-	-	-	-	-	-	-	-	-
204601	Window curtain side right assembly (Specify set number) .....	-	-	-	1	1	-	-	-	-	-	-
212206	Window curtain side right assembly (Specify set number) .....	-	1	-	-	-	-	-	-	-	-	-
185308	Window curtain side left assembly (Specify set number) .....	-	-	-	-	-	-	1	-	-	-	-
204603	Window curtain side right assembly (Specify set number) .....	-	-	-	-	-	-	1	-	-	-	-
204968	Window curtain roller rear assembly ..	-	-	1	1	1	1	1	1	-	-	-
212208	Window curtain roller rear assembly ..	1	-	-	-	-	-	-	-	-	-	-
212207	Window curtain roller rear assembly ..	-	1	-	-	-	-	-	-	-	-	-
204500	Window curtain roller side right asb..	-	-	1	-	-	-	-	-	-	-	-
212209	Window curtain roller side right asb..	-	1	-	-	-	-	-	-	-	-	-
204501	Window curtain roller side left asb. .	-	-	1	-	-	-	-	-	-	-	-
212210	Window curtain roller side left asb. .	-	1	-	-	-	-	-	-	-	-	-
204492	Window curtain roller side right asb..	-	-	-	-	-	-	1	-	-	-	-
204493	Window curtain roller side left asb. .	-	-	-	-	-	-	1	-	-	-	-
204496	Window curtain roller side right asb..	-	-	-	1	1	-	-	-	-	-	-
204499	Window curtain roller side left asb. .	-	-	-	1	1	-	-	-	-	-	-
206074	Window curtain roller bracket female ..	-	-	2	2	2	1	2	1	-	-	-
185684	Window curtain roller bracket female .	-	3	1	1	1	-	1	-	-	-	-
185685	Window curtain roller bracket male ...	-	3	1	1	1	-	1	-	-	-	-
206075	Window curtain roller bracket male ...	-	-	2	2	2	1	2	1	-	-	-
211207	Window curtain stick .....	1	3	3	3	3	1	3	1	-	-	-
173514	Window curtain tassel (Specify set number) .....	1	3	3	3	3	1	3	1	-	-	-
193046	Window frame door glass channel asb. .	-	-	-	-	-	-	-	-	2	-	-
193043	Rivet 3/16 x 1-1/16" rnd. hd. ....	-	-	-	-	-	-	-	-	12	-	-
195737	Window frame and glass assembly door front right .....	-	-	-	-	-	-	-	-	-	1	-
195738	Window frame and glass assembly door front left .....	-	-	-	-	-	-	-	-	-	1	-
212382	Window frame and glass assembly door right .....	-	-	-	-	-	-	-	-	-	-	1

Piece No.	Name	No. Required													
		5633	5634A	633	634	635	636	637	638	639	643	647			
212383	Window frame and glass assembly door left .....	-	-	-	-	-	-	-	-	-	-	-	-	-	1
212122	Window front door right assembly .....	-	-	1	-	-	1	1	-	-	-	-	-	-	-
212384	Window frame and glass assembly door rear right .....	-	-	-	-	-	-	-	-	-	-	-	-	1	-
212385	Window frame and glass assembly door rear left .....	-	-	-	-	-	-	-	-	-	-	-	-	1	-
211587	Window front door right assembly .....	1	1	-	1	1	-	-	-	-	-	-	-	-	-
212124	Window front door right assembly .....	-	-	-	-	-	-	-	1	-	-	-	-	-	-
212121	Window front door left assembly .....	-	-	1	-	-	1	1	-	-	-	-	-	-	-
211588	Window front door left assembly .....	1	1	-	1	1	-	-	-	-	-	-	-	-	-
212123	Window front door left assembly .....	-	-	-	-	-	-	-	1	-	-	-	-	-	-
211402	Window front door rear pivot clamp plate .....	2	2	2	2	2	2	2	2	2	-	-	-	-	-
211432	Window front door rear pivot friction spring .....	2	2	2	2	2	2	2	2	2	-	-	-	-	-
176864	Window front door rear pivot friction spring washer .....	2	2	2	2	2	2	2	2	2	-	-	-	-	-
211433	Window front door rear pivot friction washer thin .....	2	2	2	2	2	2	2	2	2	-	-	-	-	-
211760	Window front door rear pivot friction washer thick .....	2	2	2	2	2	2	2	2	2	-	-	-	-	-
7005	Nut 5/16-24 thd. ....	4	4	4	4	4	4	4	4	4	-	-	-	-	-
212151	Window front door rear pivot friction stop washer .....	2	2	2	2	2	2	2	2	2	-	-	-	-	-
211426	Window front door pivot spring .....	4	4	4	4	4	4	4	4	4	-	-	-	-	-
211409	Window front door pivot spring cap ...	4	4	4	4	4	4	4	4	4	-	-	-	-	-
211414	Window front door pivot spring retaining nut .....	4	4	4	4	4	4	4	4	4	-	-	-	-	-
211675	Window front door rear pull to knob ..	2	2	2	2	2	2	2	2	2	-	-	-	-	-
6342	Screw No. 8 x 1-1/16" fill. hd. ..	2	2	2	2	2	2	2	2	2	-	-	-	-	-
211525	Window front door rear pull to knob screw nut No. 8-32 thd. blind .....	2	2	2	2	2	2	2	2	2	-	-	-	-	-
211541	Window front door weatherstrip right assembly .....	-	-	1	-	-	1	1	-	-	-	-	-	-	-
211538	Window front door weatherstrip right assembly .....	1	1	-	1	1	-	-	-	-	-	-	-	-	-
211542	Window front door weatherstrip right assembly .....	-	-	-	-	-	-	-	1	-	-	-	-	-	-
211540	Window front door weatherstrip left assembly .....	-	-	1	-	-	1	1	-	-	-	-	-	-	-
211537	Window front door weatherstrip left assembly .....	1	1	-	1	1	-	-	-	-	-	-	-	-	-
211543	Window front door weatherstrip left assembly .....	-	-	-	-	-	-	-	1	-	-	-	-	-	-
143554	Window glass cushion .....	x	x	x	x	x	x	x	x	x	-	-	-	-	-
195492	Window glass cushion .....	-	-	-	-	-	-	-	x	-	-	-	-	-	-
211649	Window glass cushion front door .....	x	x	x	x	x	x	x	x	-	-	-	-	-	-
185346	Window glass cushion-rear .....	-	1	1	1	1	1	1	-	-	-	-	-	-	-
183429	Window glass cushion-rear .....	1	-	-	-	-	-	-	-	-	-	-	-	-	-
211649	Window glass cushion-side .....	-	-	x	x	x	-	-	-	-	-	-	-	-	-
187965	Window glass-door .....	-	-	-	-	-	-	-	-	-	2	-	-	-	-
212386	Window glass-door .....	-	-	-	-	-	-	-	-	-	-	-	-	-	2
195741	Window glass-door front .....	-	-	-	-	-	-	-	-	-	-	2	-	-	-
212078	Window glass front door front .....	-	-	2	-	-	2	2	2	2	-	-	-	-	-
212080	Window glass front door rear .....	-	-	-	-	-	-	-	2	-	-	-	-	-	-
212079	Window glass front door rear .....	-	-	2	-	-	2	2	-	-	-	-	-	-	-
211510	Window glass front door front .....	2	2	-	2	2	-	-	-	-	-	-	-	-	-
211511	Window glass front door rear .....	2	2	-	2	2	-	-	-	-	-	-	-	-	-
162217	Window glass partition bumper .....	-	-	-	-	2	-	-	-	-	-	-	-	-	-



Piece No.	Name	No. Required											
		5633	5633A	633	634	635	636	637	638	639	643	647	
212387	Window glass door rear .....	-	-	-	-	-	-	-	-	-	-	2	-
185336	Window glass door rear .....	-	-	2	-	-	2	-	-	-	-	-	-
185570	Window glass door rear .....	2	2	-	2	2	-	-	-	-	-	-	-
195717	Window glass door rear bumper .....	-	-	-	-	-	-	-	-	-	-	8	4
181537	Window glass partition .....	-	-	-	-	1	-	-	-	-	-	-	-
212170	Window glass partition .....	1	1	-	-	-	-	-	-	-	-	-	-
185347	Window glass rear .....	-	1	1	1	1	1	1	-	-	-	-	-
172284	Window glass rear .....	-	-	-	-	-	-	-	1	-	-	-	-
183432	Window glass rear .....	1	-	-	-	-	-	-	-	-	-	-	-
212083	Window glass side .....	-	-	2	-	-	-	-	-	-	-	-	-
212084	Window glass side .....	-	-	-	2	2	-	-	-	-	-	-	-
187840	Window glass side .....	-	-	-	-	-	-	2	-	-	-	-	-
51331	Window glass packing .....	x	x	x	x	x	x	x	x	x	-	-	-
212106	Window glass and retainer front door front right assembly .....	-	-	1	-	-	1	1	1	-	-	-	-
211635	Window glass and retainer front door front right assembly .....	1	1	-	1	1	-	-	-	-	-	-	-
212107	Window glass and retainer front door front left assembly .....	-	-	1	-	-	1	1	1	-	-	-	-
211596	Window glass and retainer front door front left assembly .....	1	1	-	1	1	-	-	-	-	-	-	-
212132	Window glass and retainer front door rear assembly-right .....	-	-	1	-	-	1	1	-	-	-	-	-
212555	Window glass and retainer front door rear assembly-left .....	-	-	1	-	-	1	1	-	-	-	-	-
211597	Window glass and retainer front door rear assembly-right .....	1	1	-	1	1	-	-	-	-	-	-	-
212133	Window glass and retainer front door rear assembly-right .....	-	-	-	-	-	-	-	1	-	-	-	-
212259	Window glass and retainer front door rear assembly-left .....	-	-	-	-	-	-	-	1	-	-	-	-
212257	Window glass and retainer front door rear assembly-left .....	1	1	-	1	1	-	-	-	-	-	-	-
212290	Window glass retainer front door center weatherstrip .....	x	x	x	x	x	x	x	-	-	-	-	-
212134	Window glass and retainer side asb. ..	-	-	2	-	-	-	-	-	-	-	-	-
212135	Window glass and retainer side asb. ..	-	-	-	2	2	-	-	-	-	-	-	-
212365	Window glass and retainer side asb. ..	-	2	-	-	-	-	-	-	-	-	-	-
193044	Window lifter assembly door right ....	-	-	-	-	-	-	-	-	1	-	-	-
193045	Window lifter assembly door left .....	-	-	-	-	-	-	-	-	-	-	-	-
178926	Window lifter bumper rear door .....	1	1	-	2	2	-	-	-	-	-	-	-
178787	Window lifter bumper rear .....	-	-	-	-	-	-	-	1	-	-	-	-
177000	Window lifter bumper rear door .....	-	-	-	-	-	2	-	-	-	-	-	-
177003	Window lifter bumper side .....	-	-	-	-	-	-	2	-	-	-	-	-
193050	Window lifter bumper door .....	-	-	-	-	-	-	-	-	2	-	-	-
183850	Window lifter door rear right assembly	-	-	1	-	-	1	-	-	-	-	-	-
184052	Window lifter door rear right assembly	1	1	-	1	1	-	-	-	-	-	-	-
183851	Window lifter door rear left assembly.	-	-	1	-	-	1	-	-	-	-	-	-
184053	Window lifter door rear left assembly.	1	1	-	1	1	-	-	-	-	-	-	-
181759	Window lifter partition assembly .....	-	-	-	-	1	-	-	-	-	-	-	-
212171	Window lifter partition assembly .....	1	1	-	-	-	-	-	-	-	-	-	-
173415	Window lifter rear assembly .....	-	-	-	-	-	-	-	1	-	-	-	-
187879	Window lifter side right assembly ....	-	-	-	-	-	-	1	-	-	-	-	-
187878	Window lifter side left assembly .....	-	-	-	-	-	-	1	-	-	-	-	-
183172	Window regulator door right .....	-	-	-	-	-	-	-	-	1	-	-	-
183173	Window regulator door left .....	-	-	-	-	-	-	-	-	1	-	-	-
211895	Window regulator front door right asb.	1	1	1	1	1	1	1	1	-	-	-	-
212416	Window regulator front door right asb.	-	-	-	-	-	-	-	-	-	1	1	-
211894	Window regulator front door left asb..	1	1	1	1	1	1	1	1	-	-	-	-
212417	Window regulator front door left asb..	-	-	-	-	-	-	-	-	-	1	1	-
5447	Lockwasher 1/4" Shakeproof .....	4	4	4	4	4	4	4	4	-	-	-	-

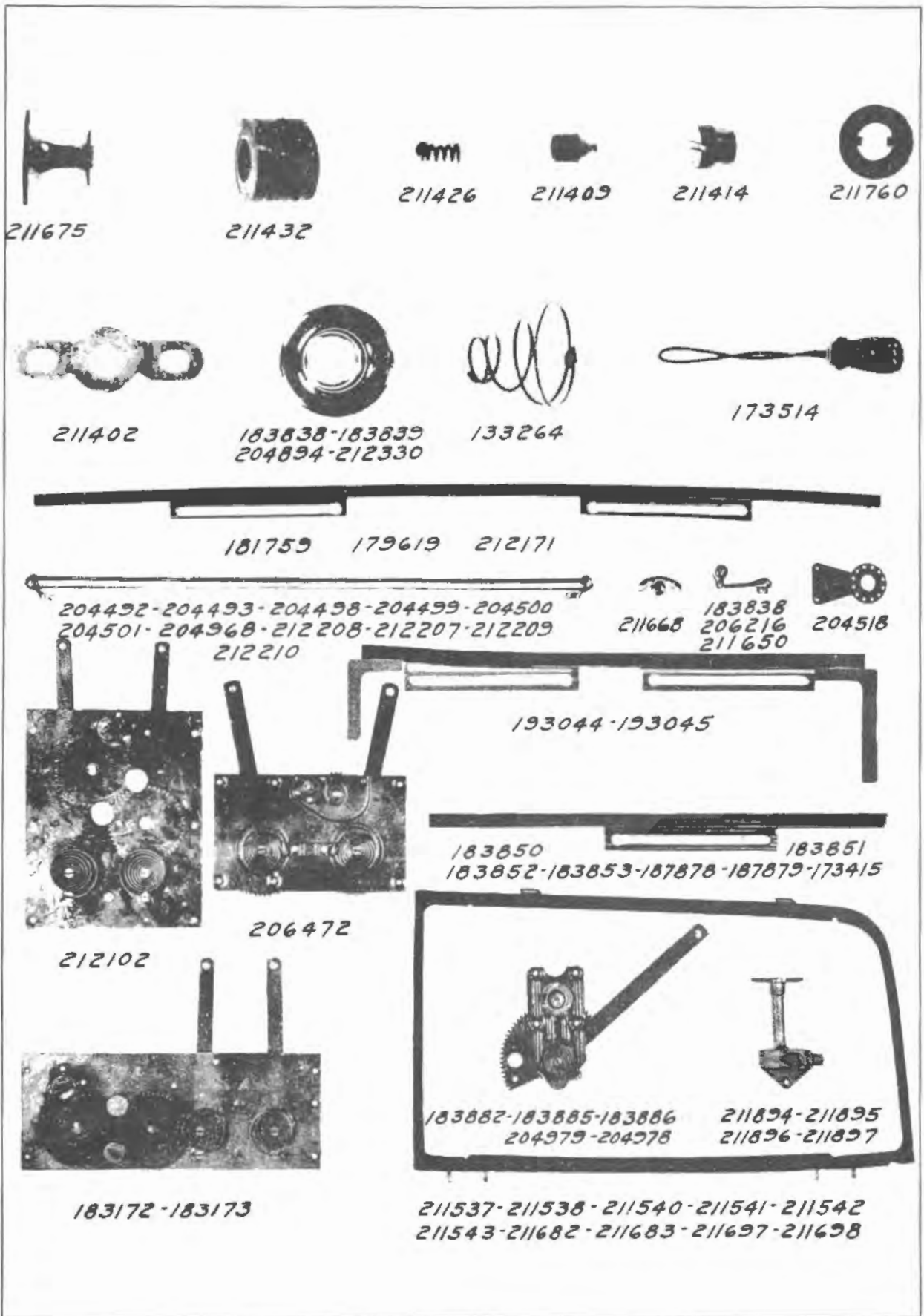



Piece No.	Name	No. Required										
		5633	5633A	633	634	635	636	637	638	639	643	647
7004	Nut 1/4-28 thd. ....	4	4	4	4	4	4	4	4	-	-	-
211650	Window regulator front door handle ...	2	2	2	2	2	2	2	2	-	-	-
204978	Window regulator rear door right .....	1	1	1	1	1	1	-	-	-	-	-
195790	Window regulator rear door right .....	-	-	-	-	-	-	-	-	-	1	-
204979	Window regulator rear door rear left .	1	1	1	1	1	1	-	-	-	-	-
195791	Window regulator rear door rear left .	-	-	-	-	-	-	-	-	-	1	-
183838	Window regulator handle long .....	2	2	2	2	2	2	2	1	2	4	2
206216	Window regulator handle-partition ....	1	1	-	-	1	-	-	-	-	-	-
183839	Window regulator handle escutcheon plate .....	4	4	4	4	4	4	4	3	2	4	2
212330	Window regulator handle escutcheon plate .....	1	1	-	-	-	-	-	-	-	-	-
204894	Window regulator handle escutcheon plate-partition .....	-	-	-	-	1	-	-	-	-	-	-
133264	Window regulator handle escutcheon plate spring .....	-	-	-	-	-	4	4	3	2	4	2
204518	Window regulator handle escutcheon plate spring plate assembly .....	2	2	2	2	2	2	-	-	-	-	-
204519	Window regulator handle escutcheon plate spring plate extension .....	2	2	2	2	2	2	-	-	-	-	-
133339	Window regulator handle insert .....	5	5	6	6	7	4	4	3	2	-	-
132972	Window regulator handle pin .....	6	6	-	-	-	4	4	3	2	4	2
147910	Window regulator handle screw No. 8- 32 x 5/8" headless .....	1	1	-	-	1	-	-	-	-	-	-
206472	Window regulator partition .....	-	-	-	-	1	-	-	-	-	-	-
212102	Window regulator partition .....	1	1	-	-	-	-	-	-	-	-	-
183882	Window regulator rear .....	-	-	-	-	-	-	-	1	-	-	-
187836	Window regulator side right assembly .	-	-	-	-	-	-	1	-	-	-	-
211897	Window regulator side right assembly .	-	1	1	1	1	-	-	-	-	-	-
211896	Window regulator side left assembly ..	-	1	1	1	1	-	-	-	-	-	-
187835	Window regulator side left assembly ..	-	-	-	-	-	-	1	-	-	-	-
3868	Window regulator side assembly washer 1/4" std. ....	-	4	4	4	4	-	-	-	-	-	-
5447	Lockwasher 1/4" Shakeproof .....	-	4	4	4	4	-	-	-	-	-	-
7004	Nut 1/4-28 thd. ....	-	4	4	4	4	-	-	-	-	-	-
211668	Window regulator side handle .....	-	2	2	2	2	-	-	-	-	-	-
183839	Window regulator side handle escutcheon plate .....	-	2	2	2	2	-	-	-	-	-	-
133264	Window regulator side handle escutcheon plate spring .....	-	2	6	6	6	-	-	-	-	-	-
132972	Window regulator side handle pin .....	-	2	6	6	6	-	-	-	-	-	-
193041	Window runway door front .....	-	-	-	-	-	-	-	-	2	2	2
193042	Window runway door rear .....	-	-	-	-	-	-	-	-	2	6	2
181732	Window runway partition .....	-	-	-	-	2	-	-	-	-	-	-
212103	Window runway partition .....	2	2	-	-	-	-	-	-	-	-	-
185604	Window runway rear door .....	2	2	2	2	2	2	-	-	-	-	-
195212	Window runway rear door .....	2	2	2	2	2	2	-	-	-	-	-
173421	Window runway rear .....	-	-	-	-	-	-	-	2	-	-	-
136008	Window runway shim 1/32 x 3/8 x 40 ...	x	x	x	x	x	x	x	x	-	-	-
132429	Window runway shim 1/16 x 3/8 x 40 ...	x	x	x	x	x	x	x	x	-	-	-
193030	Window runway side front .....	-	-	-	-	-	-	2	-	-	-	-
193031	Window runway side rear .....	-	-	-	-	-	-	2	-	-	-	-
212144	Window side right assembly .....	-	-	1	-	-	-	-	-	-	-	-
212212	Window side right assembly .....	-	1	-	-	-	-	-	-	-	-	-
212146	Window side right assembly .....	-	-	-	1	1	-	-	-	-	-	-
212143	Window side left assembly .....	-	-	1	-	-	-	-	-	-	-	-
212213	Window side left assembly .....	-	1	-	-	-	-	-	-	-	-	-
212145	Window side left assembly .....	-	-	-	1	1	-	-	-	-	-	-
211426	Window side pivot spring .....	-	2	2	2	2	-	-	-	-	-	-
211409	Window side pivot spring cap .....	-	2	2	2	2	-	-	-	-	-	-

Piece No.	Name	No. Required										
		5633	5633A	633	634	635	636	637	638	639	643	647
211414	Window side pivot spring retaining nut .....	-	2	2	2	2	-	-	-	-	-	-
211697	Window side weatherstrip right asb. ..	-	-	1	-	-	-	-	-	-	-	-
211682	Window side weatherstrip right asb. ..	-	-	-	1	1	-	-	-	-	-	-
211698	Window side weatherstrip left asb. ...	-	-	1	-	-	-	-	-	-	-	-
211683	Window side weatherstrip left asb. ...	-	-	-	1	1	-	-	-	-	-	-
212214	Window side weatherstrip front right .	-	1	-	-	-	-	-	-	-	-	-
212216	Window side weatherstrip front left ..	-	1	-	-	-	-	-	-	-	-	-
212215	Window side weatherstrip rear right ..	-	1	-	-	-	-	-	-	-	-	-
212217	Window side weatherstrip rear left ...	-	1	-	-	-	-	-	-	-	-	-
131316	Window stop block rubber bumper .....	4	4	4	4	4	4	4	2	-	-	-
187981	Window stop block rubber bumper .....	-	-	-	-	-	-	-	-	4	-	-
199254	Window weatherstrip partition .....	-	-	-	-	1	-	-	-	-	-	-

## WINDSHIELD

204995	Windshield assembly .....	1	1	1	1	1	1	1	1	-	-	-
187844	Windshield assembly .....	-	-	-	-	-	-	-	-	1	1	1
5989	Windshield to body screw No. 8-32 x 1/2" oval hd. ....	-	-	-	-	-	-	-	-	4	4	4
6238	Windshield to body screw No. 8-32 x 7/16" flat hd. mach. ....	22	22	22	22	22	22	22	22	-	-	-
5586	Windshield to body screw No. 8-32 x 5/16" flat hd. mach. ....	-	-	-	-	-	-	-	-	24	24	24
193107	Windshield clamp ferrule-right .....	-	-	-	-	-	-	-	-	1	1	1
193106	Windshield clamp ferrule-left .....	-	-	-	-	-	-	-	-	1	1	1
193379	Windshield cleaner dash connection ...	-	-	-	-	-	-	-	-	1	1	1
173133	Screw No. 10 x 1/2" flat head (Parker-Kalon) .....	-	-	-	-	-	-	-	-	2	2	2
211295	Windshield cleaner dash connection vacuum supply tube assembly .....	-	-	-	-	-	-	-	-	1	1	1
157477	Windshield cleaner dash connection vacuum supply tube union nut .....	-	-	-	-	-	-	-	-	2	2	2
177851	Windshield cleaner dash connection vacuum supply tube (flared tube connection adapter) .....	-	-	-	-	-	-	-	-	2	2	2
140009	Windshield cleaner hose .....	-	-	-	-	-	-	-	-	4	4	4
140008	Windshield cleaner hose .....	2	2	2	2	2	2	2	2	-	-	-
206566	Windshield cleaner intermediate tube right assembly .....	-	-	-	-	-	-	-	-	1	1	1
206567	Windshield cleaner intermediate tube left assembly .....	-	-	-	-	-	-	-	-	1	1	1
157688	Windshield cleaner intermediate tube adapter 3/16" .....	-	-	-	-	-	-	-	-	2	2	2
183463	Windshield cleaner intermediate tube union nut 3/16" .....	-	-	-	-	-	-	-	-	2	2	2
143360	Clip single .....	-	-	-	-	-	-	-	-	2	2	2
199787	Screw No. 8 x 1/2" (Parker-Kalon) binding head (Pilot point) .....	-	-	-	-	-	-	-	-	2	2	2
193388	Windshield cleaner motor complete left	-	-	-	-	-	-	-	-	1	1	1
193389	Windshield cleaner motor complete right .....	-	-	-	-	-	-	-	-	1	1	1
206022	Windshield cleaner motor complete left	1	1	1	1	1	1	1	1	-	-	-
212564	Windshield cleaner motor complete left (with dowels for fastening to header) .....	1	1	1	1	1	1	1	1	-	-	-
212565	Windshield cleaner motor complete right (with dowels for fastening to header) .....	1	1	1	1	1	1	1	1	-	-	-

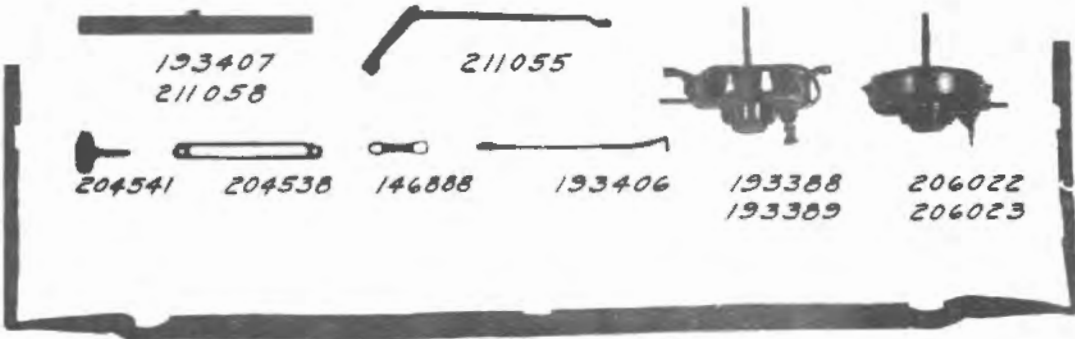

204575

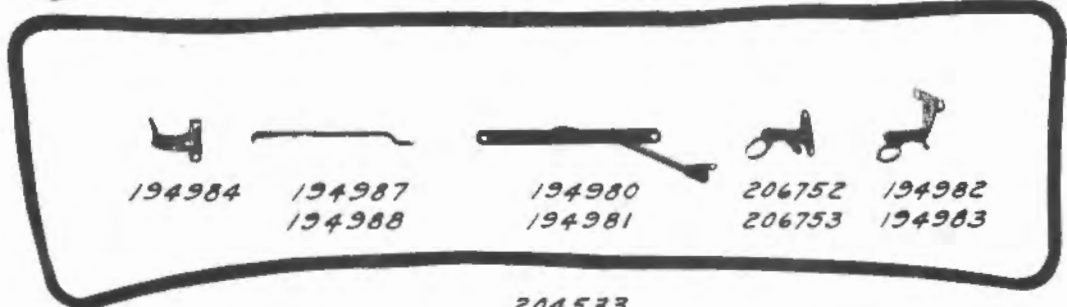

204533

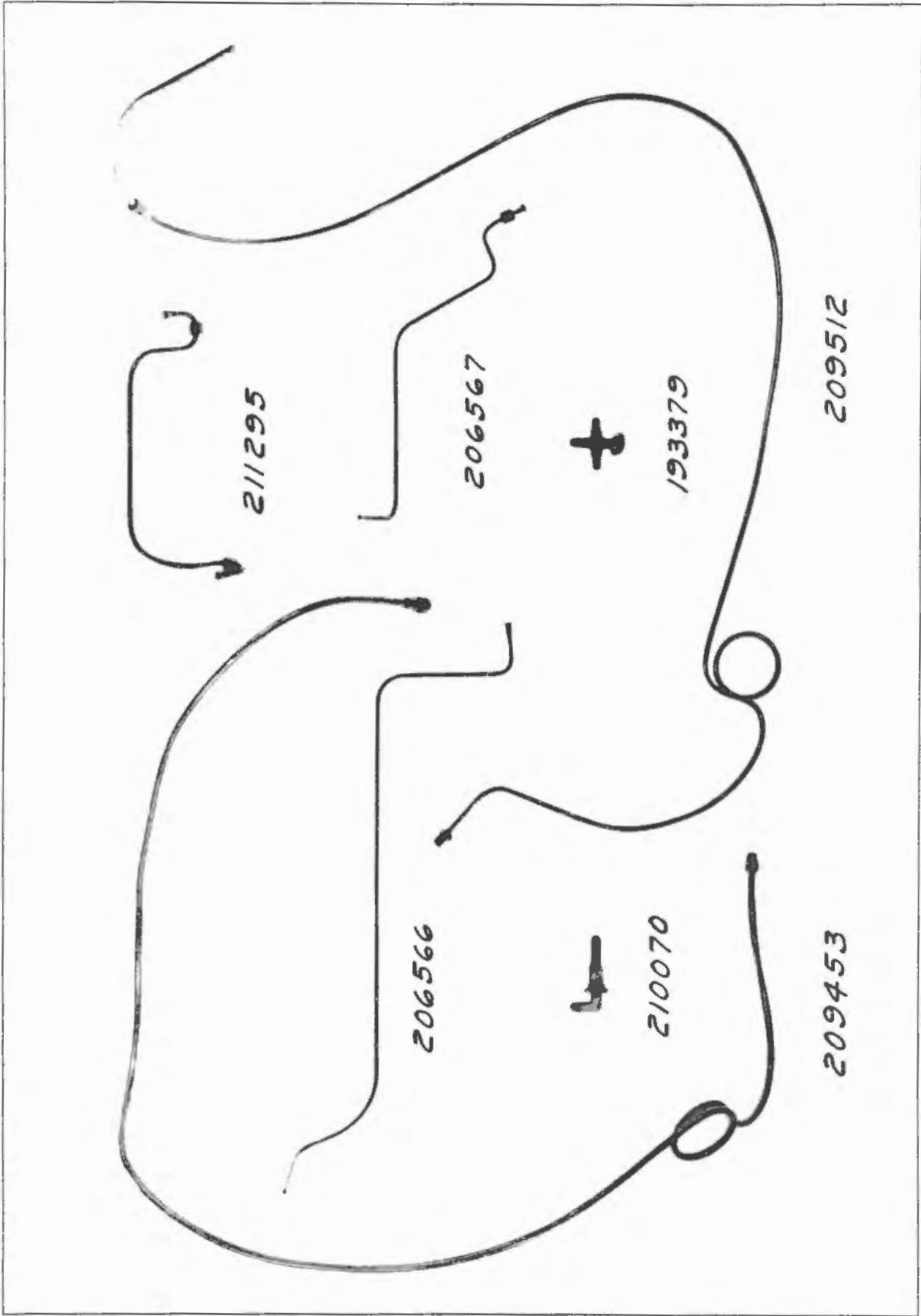



SERVICE PARTS LIST—PACKARD TWELVE

Windshield 325

Piece No.	Name	No. Required														
		5633	5633A	633	634	635	636	637	638	639	643	647				
206023	Windshield cleaner motor complete															
	right .....	1	1	1	1	1	1	1	1	-	-	-				
199138	Windshield cleaner motor attaching															
	nut .....	2	2	2	2	2	2	2	2	-	-	-				
193391	Windshield cleaner motor attaching															
	screw .....	-	-	-	-	-	-	-	-	4	4	4				
206040	Windshield cleaner motor attaching															
	washer .....	2	2	2	2	2	2	2	2	-	-	-				
206189	Windshield cleaner motor operating															
	lever knob .....	2	2	2	2	2	2	2	2	-	-	-				
212318	Windshield cleaner motor operating															
	lever knob anti-rattler .....	2	2	2	2	2	2	2	2	-	-	-				
212460	Windshield cleaner motor attaching															
	screw washer .....	-	-	-	-	-	-	-	-	4	4	4				
212459	Windshield cleaner motor shaft spacer.	-	-	-	-	-	-	-	-	2	2	2				
212458	Windshield cleaner motor shaft spacer															
	washer .....	-	-	-	-	-	-	-	-	4	4	4				
212456	Windshield cleaner motor shaft washer.	-	-	-	-	-	-	-	-	2	2	2				
212457	Windshield cleaner motor shaft washer															
	retainer .....	-	-	-	-	-	-	-	-	2	2	2				
212533	Windshield cleaner motor spacer .....	2	2	2	2	2	2	2	2	-	-	-				
210070	Windshield cleaner vacuum pump dash															
	connection .....	1	1	1	1	1	1	1	1	1	1	1				
7007	Nut 7/16-20 hex. ....	1	1	1	1	1	1	1	1	1	1	1				
5806	Lockwasher 7/16" (Shakeproof) ....	1	1	1	1	1	1	1	1	1	1	1				
3883	Washer 7/16" plain .....	1	1	1	1	1	1	1	1	1	1	1				
209512	Windshield cleaner vacuum pump to dash															
	connection tube assembly .....	1	1	1	1	1	1	1	1	1	1	1				
6261	Nut 1/4" flared tube (Inverted) ..	1	1	1	1	1	1	1	1	1	1	1				
6279	Elbow 1/4" flared tube (Inverted).	1	1	1	1	1	1	1	1	1	1	1				
209578	Clip (style No. 14) .....	1	1	1	1	1	1	1	1	1	1	1				
167261	Screw No. 10 (.187) x 3/8"															
	(Parker-Kalon) .....	1	1	1	1	1	1	1	1	1	1	1				
209453	Windshield cleaner vacuum pump to															
	manifold tube assembly .....	1	1	1	1	1	1	1	1	1	1	1				
6262	Nut 5/16" flared tube (Inverted) .	1	1	1	1	1	1	1	1	1	1	1				
6273	Elbow 5/16" flared tube (Inverted)	1	1	1	1	1	1	1	1	1	1	1				
6271	Tee 5/16" flared tube (Inverted) .	1	1	1	1	1	1	1	1	1	1	1				
5867	Union nut 5/16" flared tube .....	1	1	1	1	1	1	1	1	1	1	1				
209579	Windshield cleaner vacuum pump tube															
	clip .....	2	2	2	2	2	2	2	2	2	2	2				
193407	Windshield cleaner wiper .....	-	-	-	-	-	-	-	-	2	2	2				
211058	Windshield cleaner wiper .....	2	2	2	2	2	2	2	2	-	-	-				
193406	Windshield cleaner wiper arm .....	-	-	-	-	-	-	-	-	2	2	2				
211055	Windshield cleaner wiper arm .....	2	2	2	2	2	2	2	2	-	-	-				
146888	Windshield cleaner wiper arm pressure															
	clip .....	-	-	-	-	-	-	-	-	2	2	2				
193269	Windshield cowl weatherstrip .....	-	-	-	-	-	-	-	-	1	1	1				
206752	Windshield finger pull assembly-right.	1	1	1	1	1	1	1	1	-	-	-				
206753	Windshield finger pull assembly-left .	1	1	1	1	1	1	1	1	-	-	-				
194982	Windshield finger pull assembly-left .	-	-	-	-	-	-	-	-	1	1	1				
194983	Windshield finger pull assembly-right.	-	-	-	-	-	-	-	-	1	1	1				
194984	Windshield finger pull bracket .....	-	-	-	-	-	-	-	-	1	1	1				
194868	Windshield finger pull cap nut .....	-	-	-	-	-	-	-	-	2	2	2				
194869	Windshield finger pull cap nut spring.	-	-	-	-	-	-	-	-	2	2	2				
212675	Windshield frame and glass assembly ..	1	1	1	1	1	1	1	1	-	-	-				
194939	Windshield frame and glass assembly ..	-	-	-	-	-	-	-	-	1	1	1				
212088	Windshield glass .....	1	1	1	1	1	1	1	1	-	-	-				
193209	Windshield glass .....	-	-	-	-	-	-	-	-	1	1	1				
206808	Windshield glass cushion thick .....	x	x	x	x	x	x	x	x	-	-	-				

Piece No.	Name	No. Required										
		5633	5633A	633	634	635	636	637	638	639	643	647
206609	Windshield glass cushion thin .....	x	x	x	x	x	x	x	x	-	-	-
194986	Windshield hinge weatherblock .....	-	-	-	-	-	-	-	-	1	1	1
204547	Windshield hinge weatherstrip .....	1	1	1	1	1	1	1	1	-	-	-
193689	Windshield hinge weatherstrip .....	-	-	-	-	-	-	-	-	1	1	1
206737	Windshield hinge .....	1	1	1	1	1	1	1	1	-	-	-
206739	Windshield hinge screw .....	13	13	13	13	13	13	13	13	-	-	-
194981	Windshield locking mechanism-right ...	-	-	-	-	-	-	-	-	1	1	1
194980	Windshield locking mechanism-left ...	-	-	-	-	-	-	-	-	1	1	1
194864	Windshield locking mechanism lower screw .....	-	-	-	-	-	-	-	-	2	2	2
194865	Windshield locking mechanism upper screw .....	-	-	-	-	-	-	-	-	2	2	2
194987	Windshield locking mechanism link- right .....	-	-	-	-	-	-	-	-	1	1	1
194988	Windshield locking mechanism link-left	-	-	-	-	-	-	-	-	1	1	1
194878	Windshield mechanism lock cap screw- right hand .....	-	-	-	-	-	-	-	-	1	1	1
194986	Windshield mechanism lock cap screw- right hand washer .....	-	-	-	-	-	-	-	-	1	1	1
204575	Windshield opening weatherstrip .....	1	1	1	1	1	1	1	1	-	-	-
204533	Windshield sash glass retainer weatherstrip .....	1	1	1	1	1	1	1	1	-	-	-
206734	Windshield sector-right .....	1	1	1	1	1	1	1	1	-	-	-
211434	Windshield sector-left .....	1	1	1	1	1	1	1	1	-	-	-
206735	Windshield sector screw .....	2	2	2	2	2	2	2	2	-	-	-
204538	Windshield sector clamp ferrule .....	2	2	2	2	2	2	2	2	-	-	-
204546	Windshield sector clamp screw nut ...	2	2	2	2	2	2	2	2	-	-	-
204544	Windshield sector clamp nut washer- inside .....	2	2	2	2	2	2	2	2	-	-	-
212244	Windshield sector clamp nut washer- outside .....	2	2	2	2	2	2	2	2	-	-	-
204541	Windshield sector clamp screw and nut assembly .....	2	2	2	2	2	2	2	2	-	-	-
6056	Windshield sector clamp screw lock- washer 3/16" Shakeproof .....	2	2	2	2	2	2	2	2	-	-	-
204539	Windshield sector clamp spacer .....	2	2	2	2	2	2	2	2	-	-	-

### TRIMMING

To avoid errors due to difference in texture and shade, please furnish sample when ordering trimming material.

200777	Assembly-cowl trim panel-right (Specify set number) .....	-	-	1	1	1	1	1	1	-	-	-
200776	Assembly-cowl trim panel-left (Specify set number) .....	-	-	1	1	1	1	1	1	-	-	-
200926	Assembly-cowl trim panel-left (Specify set number) .....	-	-	-	-	-	-	-	-	1	-	-
200927	Assembly-cowl trim panel-right (Specify set number) .....	-	-	-	-	-	-	-	-	1	-	-
211397	Assembly-door trimming front-left (Specify set number) .....	-	-	-	-	1	-	-	-	-	-	-
211391	Assembly-door trimming front-left (Specify set number) .....	-	-	1	-	-	1	1	1	-	-	-
200901	Assembly-door trimming front-left (Specify set number) .....	-	-	-	-	-	-	-	-	1	-	-
211393	Assembly-door trimming front-left (Specify set number) .....	-	-	-	1	-	-	-	-	-	-	-

Piece No.	Name	No. Required										
		5633	5633A	633	634	635	636	637	638	639	643	647
211392	Assembly-door trimming front-right (Specify set number) .....	-	-	1	-	-	1	1	1	-	-	-
200902	Assembly-door trimming front-right (Specify set number) .....	-	-	-	-	-	-	-	-	1	-	-
211394	Assembly-door trimming front-right (Specify set number) .....	-	-	-	1	-	-	-	-	-	-	-
211398	Assembly-door trimming front-right (Specify set number) .....	-	-	-	-	1	-	-	-	-	-	-
200583	Assembly-door trimming rear-left (Specify set number) .....	-	-	1	-	-	1	-	-	-	-	-
200584	Assembly-door trimming rear-left (Specify set number) .....	-	-	-	1	1	-	-	-	-	-	-
200585	Assembly-door trimming rear-right (Specify set number) .....	-	-	1	-	-	1	-	-	-	-	-
200586	Assembly-door trimming rear-right (Specify set number) .....	-	-	-	1	1	-	-	-	-	-	-
200782	Assembly-headlining (Specify set number) .....	-	-	1	-	-	-	-	-	-	-	-
200817	Assembly-headlining (Specify set number) .....	-	-	-	1	-	-	-	-	-	-	-
200789	Assembly-headlining (Specify set number) .....	-	-	-	-	-	1	-	-	-	-	-
200836	Assembly-headlining (Specify set number) .....	-	-	-	-	-	-	1	-	-	-	-
200837	Assembly-headlining (Specify set number) .....	-	-	-	-	-	-	-	1	-	-	-
178986	Assembly-headlining rear (Specify set number) .....	-	-	-	-	1	-	-	-	-	-	-
139910	Binding cloth wire-on (Specify set number) .....	x	x	x	x	x	x	x	x	-	-	-
167438	Binding cloth wire-on (cordless) 1/2" wide (Specify set number) .....	x	x	-	-	x	-	-	-	-	-	-
156689	Binding 1-1/8" leather colonial grain (Specify set number) .....	-	-	-	-	-	-	-	x	x	-	-
156596	Binding lace 7/16" (Specify set number) .....	-	-	-	x	x	-	x	x	x	-	-
176578	Binding leather wire-on colonial grain (Specify set number) .....	-	-	-	-	x	-	-	x	x	-	-
206731	Binding rattan 5/16" half rnd. ....	-	-	x	x	x	-	-	-	-	-	-
212374	Binding weatherstrip (Specify set number) .....	x	x	x	x	x	x	x	x	-	-	-
5579	Brad No. 19 x 3/4" (Taper Head) .....	x	x	x	x	x	x	x	x	-	-	-
6231	Brad No. 20 x 3/8" .....	x	x	x	x	x	x	x	x	-	-	-
5738	Brad No. 19 x 1/2" (Taper Head) .....	x	x	x	x	x	x	x	x	-	-	-
29595	Burlap 10 oz. 40" wide .....	x	x	x	x	x	x	x	x	x	-	-
166480	Button mould No. 22 ligne upholsters shell .....	-	-	-	-	-	-	-	-	16	-	-
166479	Button mould No. 22 ligne upholsters filler .....	-	-	-	-	-	-	-	-	16	-	-
166478	Button mould No. 22 ligne upholsters eye .....	-	-	-	-	-	-	-	-	16	-	-
184555	Button leather covered upholsters tufting (Specify set number) .....	-	-	-	-	-	-	-	-	16	-	-
200996	Carpet rubber set 36" wide .....	-	-	-	-	-	-	x	x	x	-	-
29651	Cloth cotton 36" wide .....	x	x	x	x	x	x	x	x	-	-	-
185467	Cord 5/64" manila .....	x	x	x	x	x	x	x	x	-	-	-
29790	Cord-window curtain guide (Specify set number) .....	x	x	x	x	x	x	x	x	-	-	-
179401	Cord welt enameled drill .....	x	x	x	x	x	x	x	x	x	-	-
195209	Cord welt enameled drill .....	x	x	x	x	x	x	x	x	-	-	-

Piece No	Name	No. Required										
		5633	5633A	633	634	635	636	637	638	639	643	647
113822	Cord welt enameled drill .....	X	X	X	X	-	X	-	X	X	-	-
159187	Cord welt 3/4 x 1/4 colonial leather (Specify set number) .....	-	-	-	-	X	-	-	X	X	-	-
182627	Cord welt leather colonial grain 21/32 x 5/32 (Specify set number) ..	-	-	-	-	X	-	-	-	X	-	-
156696	Cord welt 11/16 x 3/16 leather colonial grain (Specify set number).	-	-	-	-	-	-	-	-	X	-	-
182628	Cord welt seaming lace 3/8 x 3/4 .....	-	-	-	-	-	X	-	-	-	-	-
127253	Cord welt seaming lace 9/32 x 5/8 (Specify set number) .....	X	X	X	X	X	X	X	X	-	-	-
173243	Cord welt seaming lace 11/16 x 3/16 (Specify set number) .....	X	X	X	X	X	X	X	X	-	-	-
161787	Drill white cotton 7 oz. 36" wide ....	X	X	X	X	X	X	X	X	X	-	-
105025	Drill enameled 50" wide-long grain ...	X	X	X	X	X	X	X	X	-	-	-
169249	Drill sized plain 36" wide .....	X	X	X	-	-	X	-	-	-	-	-
200525	Duck-black double filled 1.35-50" ....	X	X	X	X	X	X	X	X	X	-	-
113981	Fabric 54" upholstering (Specify set number) .....	X	X	X	X	X	X	X	X	-	-	-
200467	Fabric top material 54" wide .....	-	-	-	-	-	-	-	-	X	-	-
174513	Fabric 54" filled mole skin .....	X	X	X	X	X	X	X	X	X	-	-
156541	Fabric-roof covering 45" wide .....	-	-	X	X	X	X	X	X	-	-	-
184863	Fabric-roof covering 45" wide (Turtlegrain) .....	X	X	-	-	-	-	-	-	-	-	-
204346	Felt-top rear bow filler .....	-	-	-	-	-	-	-	-	X	-	-
195338	Felt-top bow filler .....	-	-	-	-	-	-	-	-	X	-	-
156692	Gimp 1/2" imitation black colonial leather .....	X	X	X	X	X	X	X	X	X	-	-
175234	Gimp 3/4" leather colonial grain .....	-	-	-	-	-	-	-	-	X	-	-
206913	Gimp 3/4" leather skiver grain (Specify set number) .....	X	X	X	X	X	X	X	X	-	-	-
192218	Gimp 1/2" leather skiver grain (Specify set number) .....	X	X	X	X	-	X	X	X	-	-	-
170310	Gimp 1/2" leather colonial grain (Specify set number) .....	-	-	-	-	X	-	-	-	X	-	-
214054	Hair interlaced 52" wide .....	-	-	X	X	X	-	-	X	X	-	-
163380	Hair pad 36" wide (1/4" all cow hair burlap center) .....	X	X	X	X	X	X	X	X	X	-	-
127473	Hair Wilson and Co. super bovine grey or its equivalent .....	-	-	-	X	X	X	-	-	-	-	-
123507	Leather imitation (Textileather Co. No. 95153 color .090 or its equivalent) .....	-	-	-	-	-	-	-	X	X	-	-
183986	Leather-Turtlegrain-Landau (black) ...	X	X	-	-	-	-	-	-	-	-	-
156346	Leather imitation colonial grain (Specify set number) .....	X	X	X	X	X	X	X	X	X	-	-
156348	Leather trimming (colonial grain) (Specify set number) .....	-	-	-	-	X	-	-	X	X	-	-
161778	Leather binding (Specify set number) .	X	X	X	X	X	-	-	-	-	-	-
192303	Muslin rubber 54" wide .....	X	X	X	X	X	X	X	X	X	-	-
140935	Paper board 1/2 x 48" .....	X	X	X	X	X	X	X	X	X	-	-
135117	Paper board shim 1/16 x 1 x 36" .....	X	X	X	X	X	X	X	X	X	-	-
211171	Plush high pile worsted (Specify set number) .....	X	X	X	X	X	X	X	-	-	-	-
167422	Rubber riser 3/8" half oval .....	X	X	X	X	X	X	X	-	X	-	-
115023	Rubber riser 3/8" half oval .....	X	X	X	-	-	X	-	-	-	-	-
113983	Silk curtain 22" wide (Specify set number) .....	X	X	X	X	X	X	X	X	-	-	-
29652	Tacks-japanned lace 2 oz. .....	X	X	X	X	X	X	X	X	X	-	-
106964	Tacks-gimp 3 oz. japanned .....	X	X	X	X	X	X	X	X	X	-	-
113812	Tacks-gimp 4 oz. japanned .....	X	X	X	X	X	X	X	X	X	-	-

SERVICE PARTS LIST—PACKARD TWELVE

Trimming 329

Piece No.	Name	No. Required										
		5633	5633A	633	634	635	636	637	638	639	643	647
29657	Tacks-japanned lace 4 oz. ....	X	X	X	X	X	X	X	X	X	-	-
128467	Tacks-japanned lace 8 oz. ....	-	-	-	-	-	-	-	X	X	-	-
178961	Tacks-japanned lace 10 oz. ....	-	-	-	-	-	-	X	-	-	-	-
211930	Tacks-trimmers 2-1/2 oz. galvanized ..	-	-	-	-	-	-	-	-	X	-	-
211931	Tacks-trimmers 4 oz. galvanized .....	-	-	-	-	-	-	-	-	X	-	-
211932	Tacks-trimmers 10 oz. galvanized .....	-	-	-	-	-	-	-	-	X	-	-
29662	Tacks-trimmers 1-1/2 oz. japanned ....	X	X	X	X	X	X	X	X	X	-	-
29663	Tacks-trimmers 2-1/2 oz. japanned ....	X	X	X	X	X	X	X	X	X	-	-
29664	Tacks-trimmers 4 oz. japanned .....	X	X	X	X	X	X	X	X	X	-	-
29666	Tacks-trimmers 10 oz. japanned .....	X	X	X	X	X	X	X	X	X	-	-
206657	Tacks-upholsters .....	X	X	X	X	X	-	X	-	-	-	-
206655	Tacks-upholsters shell .....	X	X	X	X	X	-	X	-	-	-	-
113789	Tacks-gimp 6 oz. japanned .....	X	X	X	X	X	X	X	X	X	-	-
206656	Tacks-upholsters tack .....	X	X	X	X	X	-	X	-	-	-	-
29637	Thread No. "EE" spool silk .....	X	X	X	X	X	X	X	X	X	-	-
192345	Thread No. 18 linen .....	X	X	X	X	X	X	X	X	X	-	-
192346	Thread No. 25 linen .....	X	X	X	X	X	X	X	X	X	-	-
29638	Thread "A" spool silk .....	X	X	X	X	X	X	X	X	X	-	-
29640	Thread "EE" No. 18 or Dean and Sheck No. 12-4 .....	X	X	X	X	X	X	X	X	X	-	-
127808	Thread Dean and Sheck No. 20-A silk finish .....	X	X	X	X	X	X	X	X	X	-	-
200638	Thread No. 80-3 hard finish cotton ...	X	X	X	X	X	X	X	X	-	-	-
200639	Thread No. 90-3 hard finish cotton ...	X	X	X	X	X	X	X	X	-	-	-
157022	Thread Lincoln No. 6 .....	X	X	X	X	X	X	X	X	X	-	-
157586	Thread No. 1201 cord .....	X	X	X	X	X	X	X	X	X	-	-
29625	Twine No. 252 Yazoo .....	X	X	X	X	X	X	X	X	X	-	-
192208	Wadding 3" white cotton rolled 3-1/2 oz. ....	-	-	-	-	-	-	-	-	X	-	-
29627	Wadding 33" blue sheet No. 532 .....	X	X	X	X	X	X	X	X	X	-	-
200797	Wadding 5" white cotton rolled 5 oz. (100% China cotton) .....	X	X	X	X	X	X	X	-	-	-	-
192209	Wadding 5" white cotton rolled 6 oz. .	-	-	-	-	-	-	-	-	X	-	-
128040	Wadding 33" white sheet .....	X	X	X	X	X	X	X	X	X	-	-
183741	Wadding roof 41" wide .....	X	X	X	X	X	X	X	X	-	-	-
193352	Webbing 2" wide elastic .....	-	-	X	X	-	X	-	X	X	-	-
62759	Webbing 3" wide jute .....	-	-	-	X	X	-	-	-	X	-	-
172470	Wadding 4" white cotton unbleached rolled 5 oz. ....	X	X	X	X	X	X	X	X	X	-	-
139457	Wadding white cotton unbleached 6" rolled 7 oz. ....	-	-	-	-	-	-	-	X	X	-	-
192090	Windlace-cloth (Specify set number) ..	X	X	X	X	X	X	-	-	-	-	-
185488	Windlace-cloth (Specify set number)...	-	-	-	-	X	-	-	-	X	-	-

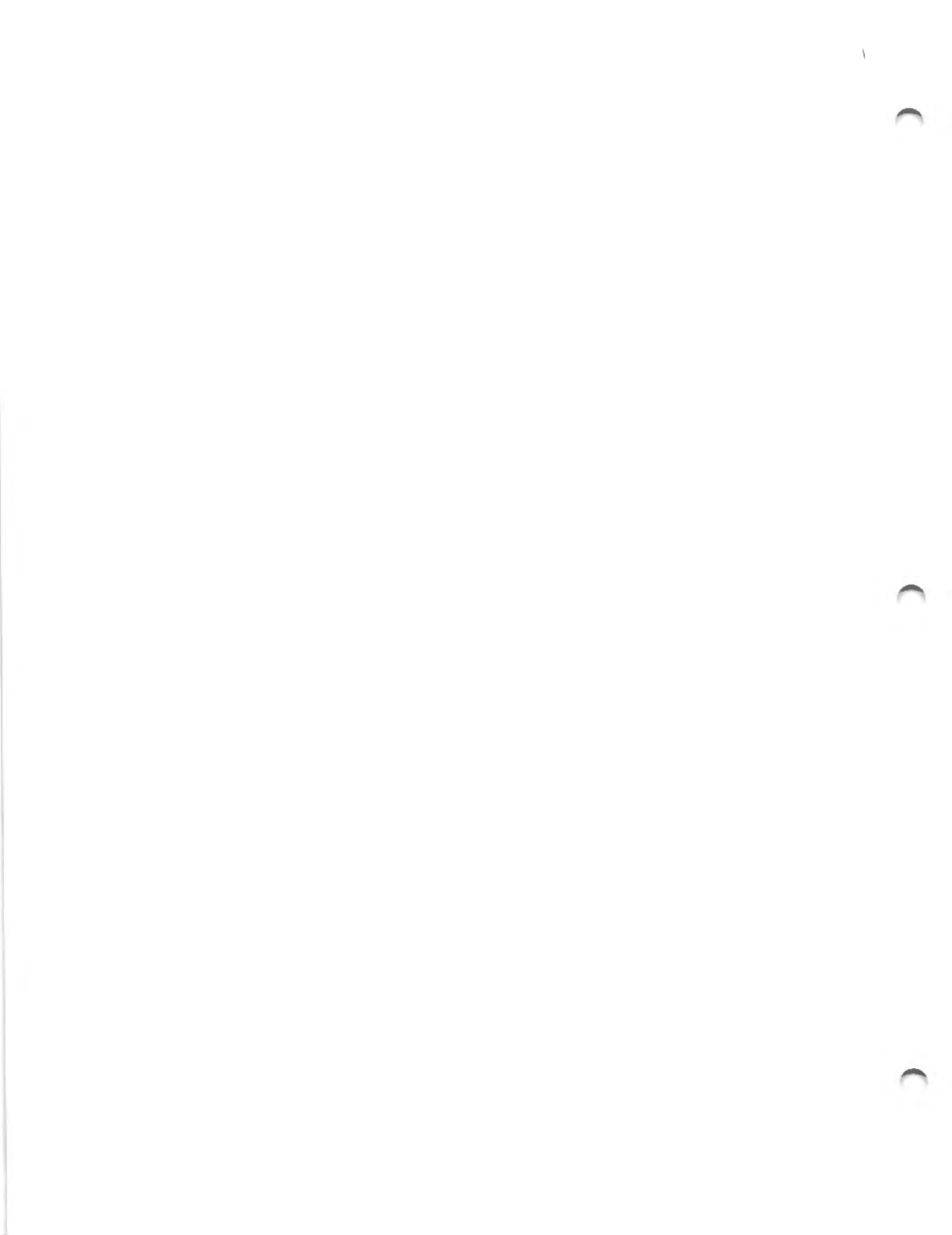

Piece No.	Name	No. Required									
		732	733	734	735	736	737	738	739	743	747
<b>BODY ATTACHING PARTS</b>											
6069	Body to frame bolt No. 1 carriage common 7/16-20 x 3-5/8" .....	2	2	2	2	2	2	2	2	2	2
199771	Body to frame bolt No. 1 carriage bolt 7/16-20 x 3-5/8" skew head .....	2	2	2	2	2	2	2	2	2	2
5282	Body to frame bolt No. 2 - screw 7/16-20 x 3-1/2" hex. hd. mach. ....	2	2	2	2	2	2	2	2	2	2
7954	Body to frame bolt No. 3 screw 7/16-20 x 3-1/4" flat hd. mach. ....	-	-	-	-	-	2	-	-	-	-
5282E	Body to frame bolt No. 3 screw 7/16-20 x 3-1/2" hex. hd. ....	-	-	-	-	-	-	-	-	-	2
5281	Body to frame bolt No. 3 screw 7/16-20 x 3-7/8" hex. hd. mach. ....	-	2	2	2	2	-	-	-	2	-
6084	Body to frame bolt No. 3 screw 7/16-20 x 4-1/8" hex. hd. ....	2	-	-	-	-	-	2	2	-	-
6283	Body to frame bolt No. 4 screw 7/16-20 x 3-11/16" flat hd. mach. ....	x	x	x	x	-	-	-	-	x	-
5968	Body to frame bolt No. 4 screw 7/16-20 x 4" flat hd. ....	x	x	x	x	-	-	-	-	x	-
7954	Body to frame bolt No. 4 screw 7/16-20 x 3-1/4" hex. hd. mach. ....	-	-	-	-	-	-	2	2	-	-
5281	Body to frame bolt No. 4 screw 7/16-20 x 3-7/8" hex. hd. mach. ....	-	-	-	-	2	2	-	-	-	-
5282	Body to frame bolt No. 4 screw 7/16-20 x 3-1/2" hex. hd. ....	-	-	-	-	-	-	-	-	-	2
5671	Body to frame bolt No. 5 screw 7/16-20 x 5-3/8" hex. hd. mach. ....	2	2	2	2	-	2	2	2	2	-
187285	Body to frame bolt No. 5 carriage bolt 7/16-20 x 7-3/16" skew head .....	-	-	-	-	2	-	-	-	-	2
6411	Body to frame bolt No. 5 carriage common 7/16-20 x 6-3/8" .....	2	-	-	-	-	-	-	-	-	2
199770	Body to frame bolt plate .....	2	2	2	2	2	2	2	2	2	2
199705	Body to frame bolt plate .....	2	2	2	2	2	2	2	2	2	2
182439	Body to frame bolt nut lock .....	4	4	4	4	2	2	2	2	4	-
182439	Body to frame bolt nut .....	-	-	-	-	-	-	-	-	-	4
131809	Body to frame bolt washer-large washer 7/16" plain special .....	2	2	2	2	2	4	4	4	2	6
131046	Body to frame bolt washer-small washer 7/16" plain special .....	12	12	12	12	10	12	12	12	12	10
5508	Body to frame bolt lockwasher 7/16" std. .	8	8	8	8	8	8	8	8	8	6
5806	Body to frame bolt lockwasher (Shakeproof)	2	2	2	2	2	2	2	2	2	4
7007	Body to frame bolt nut 7/16-20 plain std..	8	8	8	8	8	8	8	8	8	10
206192	Body to frame liner 3/16" thick .....	x	x	x	x	x	x	x	x	x	x
185273	Body to frame liner 3/16" thick .....	-	-	-	-	x	x	x	x	-	x
206193	Body to frame liner 1/4" thick .....	x	x	x	x	x	x	x	x	x	x
206194	Body to frame liner 5/16" thick .....	x	x	x	x	x	x	x	x	x	x
167924	Body to frame liner hand brake lever insulator .....	1	1	1	1	1	1	1	1	1	1
185270	Body hold down bolt bracket liner 3/8" thick .....	x	x	x	x	x	x	x	x	x	x
185274	Body hold down bolt bracket liner 1/2" thick .....	x	x	x	x	x	x	x	x	x	x
185273	Body hold down bolt bracket liner 3/16" thick .....	x	x	x	x	x	x	x	x	x	x
133104	Body hold down bolt bracket liner 1/32" thick .....	x	x	x	x	x	x	x	x	x	x
193930	Body to frame liner 3/16" thick .....	-	x	x	x	-	-	-	-	-	-
193931	Body to frame liner 7/16" thick .....	x	x	-	-	x	x	x	x	x	x



Piece No.	Name	No. Required									
		732	733	734	735	736	737	738	739	743	747
<b>ARM REST</b>											
Always send samples of material when ordering arm rest trimmed assemblies, as the assemblies upholstered to match the body interior.											
214494	Arm rest trimmed assembly-right .....	-	-	-	-	-	1	-	-	-	-
214486	Arm rest trimmed assembly-right .....	-	-	1	-	-	-	-	-	-	-
214906	Arm rest trimmed assembly-right .....	-	-	-	1	-	-	-	-	-	-
187536	Arm rest trimmed assembly-right .....	1	-	-	-	-	-	-	-	-	-
214496	Arm rest trimmed assembly-right .....	-	-	-	-	1	-	-	-	-	-
214484	Arm rest trimmed assembly-right .....	-	1	-	-	-	-	-	-	-	-
187537	Arm rest trimmed assembly-left .....	1	-	-	-	-	-	-	-	-	-
214907	Arm rest trimmed assembly-left .....	-	-	-	1	-	-	-	-	-	-
214483	Arm rest trimmed assembly-left .....	-	1	-	-	-	-	-	-	-	-
214495	Arm rest trimmed assembly-left .....	-	-	-	-	-	1	-	-	-	-
214485	Arm rest trimmed assembly-left .....	-	-	1	-	-	-	-	-	-	-
214497	Arm rest trimmed assembly-left .....	-	-	-	-	1	-	-	-	-	-
187877	Arm rest cushion-right .....	-	-	-	-	-	1	-	-	-	-
214523	Arm rest cushion-left .....	-	-	-	-	-	1	-	-	-	-
204642	Arm rest cushion-right .....	-	-	1	1	-	-	-	-	-	-
204643	Arm rest cushion-left .....	-	-	1	1	-	-	-	-	-	-
187442	Arm rest cushion-right .....	-	-	-	-	1	-	-	-	-	-
187443	Arm rest cushion-left .....	-	-	-	-	1	-	-	-	-	-
97314	Arm rest cushion-right .....	1	-	-	-	-	-	-	-	-	-
187315	Arm rest cushion-left .....	1	-	-	-	-	-	-	-	-	-
187131	Arm rest cushion-right .....	-	1	-	-	-	-	-	-	-	-
187130	Arm rest cushion-left .....	-	1	-	-	-	-	-	-	-	-
183673	Arm rest end cushion-right .....	1	-	-	-	-	-	-	-	-	-
183672	Arm rest end cushion-left .....	1	-	-	-	-	-	-	-	-	-
187144	Arm rest smoking case ash receiver .....	-	2	-	-	-	-	-	-	-	-
214712	Arm rest smoking case cigar lighter complete .....	-	2	-	-	-	-	-	-	-	-
199923	Arm rest smoking case cigar lighter .....	-	2	-	-	-	-	-	-	-	-
36111	Arm rest smoking case cigar lighter feed cable terminal insulator .....	-	2	-	-	-	-	-	-	-	-
176817	Cable terminal 3/16 eye .....	-	2	-	-	-	-	-	-	-	-
171863	Arm rest smoking case cigar lighter ground cable clip .....	-	2	-	-	-	-	-	-	-	-
182377	Arm rest smoking case cigar lighter tip ..	-	2	-	-	-	-	-	-	-	-
214866	Arm rest smoking case cover plate-right ..	-	1	-	-	-	-	-	-	-	-
214867	Arm rest smoking case cover plate-left ...	-	1	-	-	-	-	-	-	-	-
172205	Arm rest vanity case mirror .....	-	-	1	1	-	-	-	-	-	-
187596	Arm rest vanity case mirror .....	1	-	-	-	-	-	-	-	-	-
172204	Arm rest vanity case memorandum book .....	-	-	1	1	-	-	-	-	-	-
187594	Arm rest vanity case memorandum book .....	1	-	-	-	-	-	-	-	-	-
140942	Arm rest vanity case memorandum book pencil .....	-	-	1	1	-	-	-	-	-	-
180082	Arm rest vanity case memorandum book pencil .....	1	-	-	-	-	-	-	-	-	-

**BODY WIRING (Miscellaneous)**

33287	Body feed cable terminal 13/64" eye .....	1	1	1	1	1	-	1	1	1	1
166872	Body feed cable terminal 7/32" eye .....	-	-	-	-	-	1	-	-	-	-
176817	Body feed cable terminal 3/16" eye .....	2	-	-	-	-	-	-	-	-	-
36111	Cable terminal insulator .....	1	1	1	1	1	-	1	1	1	1
48616	Cable terminal insulator .....	-	-	-	-	-	1	-	-	-	-

Piece No.	Name	No. Required									
		732	733	734	735	736	737	738	739	743	747
48202	Body ground cable terminal 1/4" eye .....	5	5	5	6	5	6	1	1	1	1
5430	Body ground cable terminal screw 1/4- 28 x 1/2" hex. hd. ....	2	2	2	2	2	2	-	-	-	-
5502	Lockwasher 1/4" std. ....	2	2	2	2	2	2	-	-	-	-
7704	Nut 1/4-28 .....	2	2	2	2	2	2	-	-	-	-
176078	Body wiring cable clip .....	x	x	x	x	x	x	x	x	x	x
206706	Body wiring cable clip .....	4	-	-	4	-	-	-	-	-	-
194286	Body wiring cable clip .....	2	-	-	-	-	-	-	-	-	-
211806	Body wiring shield ground clip .....	4	2	2	5	2	2	2	-	-	-
5739	Screw No. 10-32 x 1/2" hex. hd. ....	4	2	2	5	2	2	2	-	-	-
7003	Nut No. 10-32 .....	4	2	2	5	2	2	2	-	-	-
5500	Lockwasher 3/16" .....	4	2	2	5	2	2	2	-	-	-
33287	Body wiring shield ground terminal 13/64" eye .....	4	2	2	5	2	2	2	-	-	-

BONNET DASH LINER

204980	Bonnet dash liner .....	2	2	2	2	2	2	-	-	-	-
206652	Bonnet dash liner .....	-	-	-	-	-	-	2	2	2	2
187260	Bonnet dash liner hook.....	2	2	2	2	2	2	2	2	2	2
3866	Washer 3/16" "N" std. ....	2	2	2	2	2	2	2	2	2	2
7002	Nut No. 8-32 .....	2	2	2	2	2	2	2	2	2	2

BUZZER

212040	Call buzzer complete .....	1	-	-	-	-	-	-	-	-	-
6102	Call buzzer screw No. 6-40 x 1/2" rnd. hd.	2	-	-	-	-	-	-	-	-	-
3866	Call buzzer screw washer 3/16" .....	2	-	-	-	-	-	-	-	-	-
3516	Call buzzer screw lockwasher No. 6 .....	2	-	-	-	-	-	-	-	-	-
7001	Call buzzer screw nut No. 6-40 .....	2	-	-	-	-	-	-	-	-	-

CLOCK

218337	Clock (Partition header) .....	-	-	-	1	-	-	-	-	-	-
181533	Clock (Partition header) screw .....	-	-	-	2	-	-	-	-	-	-

DICTOGRAPH

147649	Dictograph receiver .....	-	-	-	1	-	-	-	-	-	-
187609	Dictograph transmitter and winder assembly	-	-	-	1	-	-	-	-	-	-
133004	Dictograph winder .....	-	-	-	1	-	-	-	-	-	-
5310	Screw No. 8-32 x 1/4" flat hd. mach. .	-	-	-	2	-	-	-	-	-	-
5695	Lockwasher No. 8 special .....	-	-	-	2	-	-	-	-	-	-
206224	Dictograph winder bracket .....	-	-	-	1	-	-	-	-	-	-

DOME LIGHT

214882	Dome light .....	-	1	1	-	1	1	1	-	-	-
214889	Dome light-rear .....	1	-	-	1	-	-	-	-	-	-
214882	Dome light-front .....	1	-	-	1	-	-	-	-	-	-
102585	Dome light bulb (Mazda No. 81) 6 CP G-6 ..	3	1	1	3	1	1	1	-	-	-
214911	Dome light door switch cable assembly ....	-	-	-	-	-	1	-	-	-	-
193759	Dome light door switch cable assembly ....	-	-	-	-	-	1	-	-	-	-
187698	Dome light door switch cable assembly ....	-	1	-	-	1	-	-	-	-	-
212173	Dome light door switch cable assembly ....	-	-	1	-	-	-	-	-	-	-
187716	Dome light door switch cable assembly ....	1	-	-	1	-	-	-	-	-	-
185031	Dome light door switch .....	2	2	2	2	2	2	2	-	-	-
8016	Screw No. 6-40 x 3/8" oval head mach..	-	-	-	-	-	4	4	-	-	-
214884	Dome light finishing moulding .....	2	1	1	2	1	1	1	-	-	-
218875	Dome light gasket .....	2	1	1	2	1	1	1	-	-	-

Piece No.	Name	No. Required									
		732	733	734	735	736	737	738	739	743	747
214883	Dome light glass and rim .....	2	1	1	2	1	1	1	-	-	-
182459	Dome light front to instrument board switch .....	1	-	-	1	-	-	-	-	-	-
184796	Dome light rear to instrument board switch	1	-	-	-	-	-	-	-	-	-
185616	Dome light reflector (Two bulb) .....	1	-	-	1	-	-	-	-	-	-
180636	Dome light reflector (One bulb) .....	1	1	1	1	1	1	1	-	-	-
183844	Dome light switch (3 point) .....	1	1	1	2	1	1	1	-	-	-
171533	Dome light to ground cable assembly .....	-	-	-	-	-	1	-	-	-	-
199873	Dome light to ground cable assembly .....	-	1	-	-	1	-	-	-	-	-
187705	Dome light to ground cable assembly .....	1	-	1	1	-	-	-	-	-	-

### DOORS

All doors must be adjusted to each respective body. To obtain satisfactory replacement of doors, it is advisable to return the damaged door to be repaired, if possible. If this cannot be done, the customer assumes the responsibility of the new door being a satisfactory fit.

Specify on all orders the upholstery material, color and striping.

218371	Door trimmed assembly-right .....	-	-	-	-	-	-	1	1	-	-
218373	Door trimmed assembly-left .....	-	-	-	-	-	-	1	1	-	-
218377	Door trimmed assembly-front right .....	-	1	-	-	1	1	-	-	-	-
218374	Door trimmed assembly-front right .....	1	-	1	1	-	-	-	-	-	-
218381	Door trimmed assembly-front left .....	-	1	-	-	1	1	-	-	-	-
218378	Door trimmed assembly-front left .....	1	-	1	1	-	-	-	-	-	-
218391	Door trimmed assembly-rear right .....	-	-	-	-	1	-	-	-	-	-
218388	Door trimmed assembly-rear right .....	-	1	-	-	-	-	-	-	-	-
218389	Door trimmed assembly-rear right .....	-	-	1	-	-	-	-	-	-	-
218382	Door trimmed assembly-rear right .....	1	-	-	-	-	-	-	-	-	-
218390	Door trimmed assembly-rear right .....	-	-	-	1	-	-	-	-	-	-
218399	Door trimmed assembly-rear left .....	-	-	-	-	1	-	-	-	-	-
218397	Door trimmed assembly-rear left .....	-	1	-	-	-	-	-	-	-	-
218398	Door trimmed assembly-rear left .....	-	-	1	1	-	-	-	-	-	-
218392	Door trimmed assembly-rear left .....	1	-	-	-	-	-	-	-	-	-

### DOOR ARM REST

NOTE:--Always send samples of material when ordering arm rest trimmed assemblies, as the assemblies are upholstered to match the body interior.

206614	Door arm rest trimmed assembly-right .....	1	1	1	-	1	1	-	-	-	-
206616	Door arm rest trimmed assembly-right .....	-	-	-	1	-	-	-	-	-	-
206615	Door arm rest trimmed assembly-left .....	-	-	-	1	-	-	-	-	-	-
206613	Door arm rest trimmed assembly-left .....	1	1	1	-	1	1	-	-	-	-
206542	Door arm rest cushion-right .....	1	1	1	1	1	1	-	-	-	-
206543	Door arm rest cushion-left .....	1	1	1	1	1	1	-	-	-	-

### DOOR PARTS

199167	Door anti-rattler .....	-	-	-	-	-	-	2	2	-	-
204535	Door anti-rattler front upper .....	2	2	2	2	2	2	-	-	-	-
6102	Screw No. 6-40 x 1/2" rnd. hd. ....	2	2	2	2	2	2	-	-	-	-

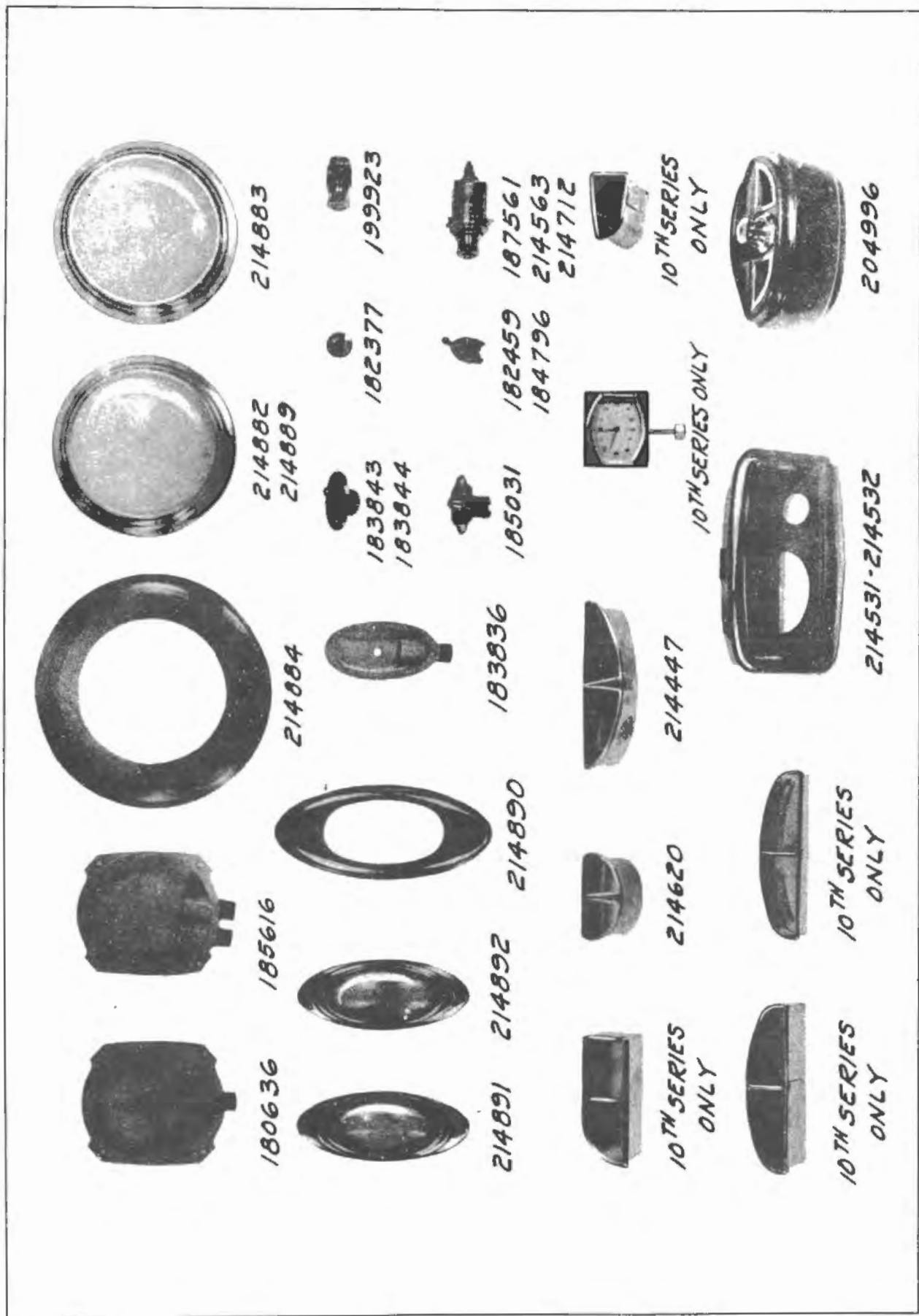



Piece No	Name	No Required									
		732	733	734	735	736	737	738	739	743	747
199167	Door anti-rattler front lower .....	2	2	2	2	2	2	-	-	-	-
218306	Door anti-rattler shim-front upper .....	x	x	x	x	x	x	-	-	-	-
218305	Door anti-rattler shim-front lower .....	x	x	x	x	x	x	-	-	-	-
218305	Door anti-rattler shim .....	-	-	-	-	-	-	x	x	-	-
218305	Door anti-rattler shim-rear .....	x	x	x	x	x	-	-	-	-	-
5667	Screw No. 10-32 x 5/8" rnd. hd. ....	2	2	2	2	2	2	-	-	-	-
199167	Door anti-rattler rear .....	2	2	2	2	2	-	-	-	-	-
185601	Door bumper 1-11/32" .....	x	x	x	x	x	x	x	x	8	4
185600	Door bumper 1-13/32" .....	x	x	x	x	x	x	x	x	x	x
218685	Door bumper 1-15/32" .....	x	x	x	x	x	x	x	x	x	x
185602	Door bumper 1-9/32" .....	x	x	x	x	x	x	x	x	x	x
164699	Door check strap .....	4	4	4	4	4	2	2	2	4	2
164359	Door check strap fastener plate .....	4	4	4	4	4	2	2	2	4	2
5253	Screw No. 10-32 x 3/4" rnd. hd. ....	4	4	4	4	4	4	4	4	-	-
167250	Door check strap guide .....	2	2	2	2	2	-	-	-	2	-
179680	Door check strap stop plate .....	2	2	2	2	2	2	2	2	2	2
206906	Door header weatherstrip front .....	-	2	-	-	2	2	-	-	-	-
206908	Door header weatherstrip front .....	2	-	2	2	-	-	-	-	-	-
206909	Door header weatherstrip rear .....	-	2	-	-	2	-	-	-	-	-
206911	Door header weatherstrip rear .....	2	-	2	2	-	-	-	-	-	-
184659	Door dove-tail female .....	4	4	4	4	4	2	2	2	4	4
119298	Door dove-tail male .....	4	4	4	4	4	2	2	2	4	4
204609	Door hinge-front center left .....	-	-	-	-	-	-	1	1	1	1
204608	Door hinge-front center right .....	-	-	-	-	-	-	1	1	1	1
212390	Door hinge-lower right .....	-	-	-	-	-	-	-	-	-	1
212391	Door hinge-lower left .....	-	-	-	-	-	-	-	-	-	1
206178	Door hinge-front lower left .....	1	1	1	1	1	1	-	-	-	-
204711	Door hinge-front lower left .....	-	-	-	-	-	-	1	1	1	-
206177	Door hinge-front lower right .....	1	1	1	1	1	1	-	-	-	-
204710	Door hinge-front lower right .....	-	-	-	-	-	-	1	1	1	1
204713	Door hinge-front upper left .....	-	-	-	-	-	-	1	1	1	1
206176	Door hinge-front upper left .....	1	1	1	1	1	1	-	-	-	-
204712	Door hinge-front upper right .....	-	-	-	-	-	-	1	1	1	1
206175	Door hinge-front upper right .....	1	1	1	1	1	1	-	-	-	-
212402	Door hinge-rear center right .....	-	-	-	-	-	-	-	-	-	1
212403	Door hinge-rear center left .....	-	-	-	-	-	-	-	-	-	1
206296	Door hinge-rear lower right .....	1	-	-	-	-	-	-	-	-	-
212404	Door hinge-rear lower right .....	-	-	-	-	-	-	-	-	-	1
212404	Door hinge-rear lower right .....	-	-	-	-	-	-	-	-	-	1
206181	Door hinge-rear lower right .....	-	1	1	1	1	-	-	-	-	-
206295	Door hinge-rear lower left .....	1	-	-	-	-	-	-	-	-	-
212405	Door hinge-rear lower left .....	-	-	-	-	-	-	-	-	-	1
212405	Door hinge-rear lower left .....	-	-	-	-	-	-	-	-	-	1
206182	Door hinge-rear lower left .....	-	1	1	1	1	-	-	-	-	-
206179	Door hinge-rear upper-right .....	1	1	1	1	1	-	-	-	-	-
212406	Door hinge-rear upper-right .....	-	-	-	-	-	-	-	-	-	1
212406	Door hinge-rear upper-right .....	1	1	1	1	1	-	-	-	-	-
206180	Door hinge-rear upper-left .....	-	-	-	-	-	-	-	-	-	1
212407	Door hinge-rear upper-left .....	-	-	-	-	-	-	-	-	-	1
6148	Screw 1/4-28 x 1/2" oval hd. ....	-	-	-	-	-	-	24	24	-	-
206869	Screw 5/16-24 x 17/32" oval hd. ....	16	16	16	16	16	16	-	-	-	-
8074	Screw 1/4-28 x 1-1/8" flat hd. ....	4	4	4	4	4	-	-	-	-	-
5820	Screw 1/4-28 x 1-31/32" oval hd. ....	4	4	4	4	4	-	-	-	-	-
8211	Screw 1/4-28 x 2-1/4" flat hd. ....	-	-	-	-	-	-	6	6	x	x
5701	Screw 1/4-28 x 9/16" flat hd. ....	16	16	16	16	16	16	-	-	-	-
5899	Lockwasher 5/16" countersunk										
	Shakeproof-special .....	32	32	32	32	32	32	24	24	24	24
206173	Door hinge pin .....	8	8	8	8	8	4	6	6	-	-
206174	Door hinge pin screw .....	8	8	8	8	8	4	6	6	-	-
5500	Door hinge pin lockwasher No. 10 std. ....	8	8	8	8	8	4	6	6	-	-
212468	Door hinge pin bushing .....	x	x	x	x	x	x	x	x	-	-
183170	Door lock front-right .....	1	1	1	1	1	1	1	1	-	1
193054	Door lock front-right .....	-	-	-	-	-	-	-	-	-	1

Piece No.	Name	No. Required									
		732	733	734	735	736	737	738	739	743	747
183171	Door lock front-left .....	1	1	1	1	1	1	1	1	-	1
193021	Door lock front-left .....	-	-	-	-	-	-	-	-	1	-
183171	Door lock rear-right .....	1	1	1	1	1	-	-	-	-	-
193021	Door lock rear-right .....	-	-	-	-	-	-	-	-	1	-
183170	Door lock rear-left .....	1	1	1	1	1	-	-	-	-	-
193054	Door lock rear-left .....	-	-	-	-	-	-	-	-	1	-
5829	Screw No. 10-32 x 7/8" flat hd. ....	8	8	8	8	8	4	4	4	-	-
5491	Lockwasher 3/16" countersunk (Shakeproof) .....	8	8	8	8	8	4	4	4	-	-
206005	Door lock handle .....	-	-	-	-	-	-	1	1	-	-
193174	Door lock handle .....	-	-	-	-	-	-	-	-	-	1
206010	Door lock handle (with key lock) .....	-	-	-	-	-	-	1	1	-	-
193177	Door lock handle (with key lock) .....	-	-	-	-	-	-	-	-	-	1
206009	Door lock handle front-left .....	1	1	1	1	1	1	-	-	-	-
206009	Door lock handle rear-right .....	-	1	1	-	1	-	-	-	-	-
193695	Door lock handle rear-right .....	-	-	-	-	-	-	-	-	1	-
206007	Door lock handle rear-left .....	1	1	1	1	1	-	-	-	-	-
193696	Door lock handle rear-left .....	-	-	-	-	-	-	-	-	1	-
206006	Door lock handle front-right (with key lock) .....	1	1	1	1	1	1	-	-	-	-
193692	Door lock handle front-right (with key lock) .....	-	-	-	-	-	-	-	-	1	-
193695	Door lock handle front-left .....	-	-	-	-	-	-	-	-	1	-
206008	Door lock handle rear-right (with key lock) .....	1	-	-	1	-	-	-	-	-	-
212168	Door lock handle screw .....	x	x	x	x	x	x	x	x	-	1
206017	Door lock handle screw .....	x	x	x	x	x	x	x	x	-	-
206043	Door lock handle screw .....	x	x	x	x	x	x	x	x	-	-
5974	Door lock handle screw No. 10-32 x 7/8" oval hd. ....	-	-	-	-	-	-	-	-	8	-
185236	Washer .....	2	1	1	2	1	1	1	1	-	1
206188	Door lock handle attaching plate (Locking handle) .....	2	1	1	2	1	1	1	1	-	-
206223	Door lock handle attaching plate .....	2	3	3	2	3	1	1	1	-	-
206187	Door lock handle escutcheon plate .....	4	4	4	4	4	2	2	2	-	-
218430	Door lock remote control assembly-right ..	-	-	-	-	-	-	-	-	-	1
218431	Door lock remote control assembly-left ...	-	-	-	-	-	-	-	-	-	1
218432	Door lock remote control assembly-front right .....	-	-	-	-	-	-	-	-	1	-
218433	Door lock remote control assembly-front left .....	-	-	-	-	-	-	-	-	1	-
218434	Door lock remote control assembly-rear right .....	-	-	-	-	-	-	-	-	1	-
218435	Door lock remote control assembly-rear left .....	-	-	-	-	-	-	-	-	1	-
193076	Door lock remote control-right .....	-	-	-	-	-	-	1	1	-	-
193075	Door lock remote control-left .....	-	-	-	-	-	-	1	1	-	-
204482	Door lock remote control-front right .....	-	1	-	-	1	1	-	-	-	-
204483	Door lock remote control-front left .....	-	1	-	-	1	1	-	-	-	-
204480	Door lock remote control-front right .....	1	-	1	1	-	-	-	-	-	-
204481	Door lock remote control-front left .....	1	-	1	1	-	-	-	-	-	-
185650	Door lock remote control-rear right .....	-	1	-	-	1	-	-	-	-	-
185700	Door lock remote control-rear left .....	-	1	-	-	1	-	-	-	-	-
185710	Door lock remote control-rear right .....	1	-	1	1	-	-	-	-	-	-
185711	Door lock remote control-rear left .....	1	-	1	1	-	-	-	-	-	-
193918	Door lock remote control handle .....	4	4	4	4	4	2	2	2	4	2
193919	Door lock remote control handle escutcheon plate .....	4	4	4	4	4	2	2	2	4	2
193078	Door lock remote control handle escutcheon plate spring .....	4	4	4	4	4	2	2	2	4	4
206610	Door lock striker (Black) .....	4	4	4	4	4	-	-	-	-	-





206173 170335 170336 199167 204535 185600  
 185601  
 185602



119298 193919 206187 193078 164359 206188  
 206223



184659 179680 206610 206611 199425  
 206612



193918 193123-193124-204736-204737-204738-204739  
 206054-206055-206056-206057-212043-212044



185650-193076 204608-204609-204710 164699  
 185700-204480 204711-204712-204713  
 185710-204481 206175-206176-206177  
 185711-204482 206178-206179-206180  
 193075-204483 206181-206182-206295  
 206296



206006 193174-193177 167250 183170 193021  
 206007 193692-193696 183171 193054  
 206008 193695  
 206009  
 206005  
 206010



Piece No.	Name	No. Required									
		732	733	734	735	736	737	738	739	743	747
218501	Door lock striker (Bright) .....	4	4	4	4	4	-	-	-	-	-
206612	Door lock striker .....	-	-	-	-	-	2	-	-	-	-
206611	Door lock striker .....	-	-	-	-	-	-	2	2	4	2
170336	Door lock striker nut .....	2	2	2	2	2	-	-	-	-	-
199425	Door lock striker adjusting plate .....	4	4	4	4	4	-	-	-	-	-
170335	Door lock striker screw .....	2	2	2	2	2	-	-	-	-	-
204739	Door scuff plate-front-left .....	1	-	1	1	-	-	-	-	-	-
204737	Door scuff plate-front-left .....	-	1	-	-	1	1	-	-	-	-
195781	Door scuff plate-front-left .....	-	-	-	-	-	-	-	-	1	-
193124	Door scuff plate-right .....	-	-	-	-	-	-	1	1	-	-
195778	Door scuff plate-right .....	-	-	-	-	-	-	-	-	-	1
193123	Door scuff plate-left .....	-	-	-	-	-	-	1	1	-	-
195779	Door scuff plate-left .....	-	-	-	-	-	-	-	-	-	1
204736	Door scuff plate-front right .....	-	1	-	-	1	1	-	-	-	-
195780	Door scuff plate-front right .....	-	-	-	-	-	-	-	-	1	-
204738	Door scuff plate-front right .....	1	-	1	1	-	-	-	-	-	-
206057	Door scuff plate-rear left .....	-	1	-	-	1	-	-	-	-	-
206055	Door scuff plate-rear left .....	-	-	1	1	-	-	-	-	-	-
212043	Door scuff plate-rear left .....	1	-	-	-	-	-	-	-	-	-
195787	Door scuff plate-rear left .....	-	-	-	-	-	-	-	-	1	-
206054	Door scuff plate-rear right .....	-	-	1	1	-	-	-	-	-	-
195786	Door scuff plate-rear right .....	-	-	-	-	-	-	-	-	1	-
212044	Door scuff plate-rear right .....	1	-	-	-	-	-	-	-	-	-
206056	Door scuff plate-rear right .....	-	1	-	-	1	-	-	-	-	-
214825	Door weatherstrip-front right .....	-	-	-	-	-	-	1	1	-	-
214826	Door weatherstrip-front left .....	-	-	-	-	-	-	1	1	-	-
214819	Door weatherstrip-rear right .....	-	-	-	-	-	-	1	1	-	-
214820	Door weatherstrip-rear left .....	-	-	-	-	-	-	1	1	-	-
214823	Door weatherstrip upper-front right .....	-	-	-	-	-	-	-	1	-	-
214824	Door weatherstrip upper-front left .....	-	-	-	-	-	-	-	1	-	-
214821	Door weatherstrip upper-rear right .....	-	-	-	-	-	-	-	1	-	-
214822	Door weatherstrip upper-rear left .....	-	-	-	-	-	-	-	1	-	-
218357	Door weatherstrip upper-left .....	-	-	-	-	-	-	1	-	-	-
218356	Door weatherstrip upper-right .....	-	-	-	-	-	-	1	-	-	-

## FASTENERS

195340	Fastener double prong-top rear curtain ...	-	-	-	-	-	-	-	-	X	-	-
195664	Fastener eyelet-top rear curtain .....	-	-	-	-	-	-	-	-	X	-	-
195341	Fastener stud screw base-top rear curtain.	-	-	-	-	-	-	-	-	X	-	-
195683	Rivet No. 2504 9/64 x 1/4" flat hd. tubular .....	-	-	-	-	-	-	-	-	-	X	-
177609	Fastener washer-top rear curtain .....	-	-	-	-	-	-	-	-	X	-	-
161792	Fastener washer-top rear curtain .....	-	-	-	-	-	-	-	-	X	-	-
193200	Snap fastener machine screw post-carpet front floor .....	X	X	X	X	X	X	X	X	X	-	-
111075	Snap fastener rivet post-rumble seat compartment door hinge cover .....	-	-	-	-	-	-	-	X	X	-	-
193199	Snap fastener rivet post-female-carpet front floor .....	X	X	X	X	X	X	X	X	X	-	-
193201	Snap fastener screw post-carpet front floor .....	X	X	X	X	X	X	X	X	X	-	-
159060	Snap fastener screw stud (self tapping) carpet front floor .....	X	X	X	X	X	X	X	X	X	-	-
159060	Snap fastener screw stud (self tapping) cowl panel tab. ....	X	X	X	X	X	X	X	X	X	-	-
115799	Snap fastener socket-carpet front floor ..	-	-	-	-	-	-	-	-	X	-	-
137510	Snap fastener socket-cowl panel tab. ....	X	X	X	X	X	X	X	X	X	-	-
112054	Snap fastener socket top-cowl panel tab. .	X	X	X	X	X	X	X	X	X	-	-

Piece No.	Name	No. Required									
		732	733	734	735	736	737	738	739	743	747
200073	Snap fastener socket-rumble seat compartment door hinge cover .....	-	-	-	-	-	-	x	x	-	-
200073	Snap fastener socket-rumble seat compartment floor carpet .....	-	-	-	-	-	-	x	x	-	-
115798	Snap fastener socket ring-carpet short prong front floor .....	-	-	-	-	-	-	-	x	-	-
206744	Snap fastener screw post-rumble seat compartment floor .....	-	-	-	-	-	-	x	x	-	-
111074	Snap fastener stud-rumble seat compartment door hinge cover .....	-	-	-	-	-	-	x	x	-	-
185412	Snap fastener wood screw stud-rear deck trim rail .....	-	-	-	-	-	-	-	x	-	-
185412	Snap fastener wood screw stud-front seat back rail .....	-	-	-	-	-	-	-	x	-	-
139150	Snap fastener socket-top envelope .....	-	-	-	-	-	-	-	x	-	-
139150	Snap fastener socket-top side rail .....	-	-	-	-	-	-	-	x	-	-
139150	Snap fastener socket-body lock pillar ....	-	-	-	-	-	-	-	x	-	-
5729	Screw No. 4-40 x 5/16" .....	-	-	-	-	-	-	-	x	-	-
139157	Snap fastener rivet stud-top side quarter.	-	-	-	-	-	-	-	x	-	-
139157	Snap fastener rivet stud-top envelope ....	-	-	-	-	-	-	-	x	-	-
175757	Snap fastener rivet post-top envelope ....	-	-	-	-	-	-	-	x	-	-
175757	Snap fastener rivet post-top side quarter.	-	-	-	-	-	-	-	x	-	-

## FLOOR BOARD

196337	Floor board battery lid .....	-	-	-	-	-	1	-	-	-	1
206476	Floor board front assembly .....	-	-	-	-	-	-	1	1	1	-
206478	Floor board front assembly .....	-	-	-	-	-	1	-	-	-	1
206477	Floor board front assembly .....	1	1	1	1	1	-	-	-	-	-
206481	Floor board front felt-front .....	1	1	1	1	1	1	1	1	1	1
206480	Floor board front felt-center .....	1	1	1	1	1	1	1	1	1	1
206479	Floor board front felt-rear .....	1	1	1	1	1	1	1	1	1	1
206482	Floor board front felt-side .....	-	-	-	-	-	-	2	2	2	-
206483	Floor board front felt-side .....	2	2	2	2	2	-	-	-	-	-
206484	Floor board front felt-side .....	-	-	-	-	-	2	-	-	-	-
206572	Floor board rear assembly .....	1	1	-	-	-	-	-	-	-	-
206571	Floor board rear assembly .....	-	-	1	1	-	-	-	-	-	-

## FLOOR CARPET

Specify color and type of binding when ordering carpet

214247	Floor carpet front assembly .....	-	-	-	-	-	-	1	-	-	-
204624	Floor carpet front assembly .....	-	-	-	-	-	-	-	1	-	-
212428	Floor carpet front assembly .....	-	-	-	-	-	-	-	-	1	-
212429	Floor carpet front assembly .....	-	-	-	-	-	-	-	-	-	1
204625	Floor carpet front assembly .....	-	-	-	-	-	1	-	-	-	-
214282	Floor carpet front assembly .....	-	-	-	1	-	-	-	-	-	-
214246	Floor carpet front assembly .....	1	1	1	-	1	-	-	-	-	-
214259	Floor carpet rear assembly .....	-	1	-	-	-	-	-	-	-	-
212430	Floor carpet rear assembly .....	-	-	-	-	-	-	-	-	1	-
212431	Floor carpet rear assembly .....	-	-	-	-	-	-	-	-	-	1
211168	Floor carpet rear assembly .....	-	-	1	1	-	-	-	-	-	-
212045	Floor carpet rear assembly .....	1	-	-	-	-	-	-	-	-	-
214258	Floor carpet rear assembly .....	-	-	-	-	1	-	-	-	-	-
211170	Floor carpet rear assembly .....	-	-	-	-	-	1	-	-	-	-
172754	Floor carpet rear compartment assembly ...	-	-	-	-	-	1	-	-	-	-
195301	Floor carpet rumble compartment assembly .	-	-	-	-	-	-	1	1	-	-

Piece No.	Name	No. Required									
		732	733	734	735	736	737	738	739	743	747
<b>FOLDING ARM REST</b>											
212602	Folding arm rest cushion .....	1	1	1	1	1	1	-	-	1	1
212590	Folding arm rest spring .....	1	1	1	1	1	-	-	-	-	-
214599	Folding arm rest spring .....	-	-	-	-	-	1	-	-	-	-
212633	Folding arm rest spring cushion .....	1	1	1	1	1	1	-	-	-	-
214658	Folding arm rest support bracket assembly.	-	-	-	-	-	1	-	-	-	-
214390	Folding arm rest support bracket assembly.	1	1	1	1	1	-	-	-	-	-
218437	Folding arm rest support bracket assembly.	-	1	-	-	-	-	-	-	1	-
218436	Folding arm rest support bracket assembly.	-	-	-	-	-	1	-	-	-	1
7824	Screw 1/4-28 x 5/8" hex. hd. ....	4	4	4	4	4	2	-	-	4	4
5992	Screw 1/4-28 x 1-5/8" hex. hd. ....	-	-	-	-	-	2	-	-	-	-
5502	Lockwasher 1/4" std. ....	4	4	4	4	4	4	-	-	4	4
7004	Nut 1/4-28 .....	4	4	4	4	4	4	-	-	4	4

**FOLDING SEAT**

Always send samples of material when ordering folding seat trimmed assemblies as the assemblies are upholstered to match the body interior.

212379	Folding seat trimmed assembly .....	-	-	2	2	-	-	-	-	-	-
212340	Folding seat trimmed assembly-right .....	1	-	-	-	-	-	-	-	-	-
212341	Folding seat trimmed assembly-left (Painted) .....	1	-	-	-	-	-	-	-	-	-
218835	Folding seat trimmed assembly-left (Nickel Plate) .....	1	-	-	-	-	-	-	-	-	-
206921	Folding seat untrimmed assembly .....	-	-	2	2	-	-	-	-	-	-
212342	Folding seat untrimmed assembly-right ....	1	-	-	-	-	-	-	-	-	-
212343	Folding seat untrimmed assembly-left (Painted) .....	1	-	-	-	-	-	-	-	-	-
218836	Folding seat untrimmed assembly-left (Nickel Plate) .....	1	-	-	-	-	-	-	-	-	-
185112	Folding seat back untrimmed assembly .....	-	-	2	2	-	-	-	-	-	-
185113	Folding seat back to seat frame screw ....	-	-	4	4	-	-	-	-	-	-
172294	Folding seat cushion spring .....	-	-	2	2	-	-	-	-	-	-
211377	Folding seat floor carpet assembly .....	-	-	2	2	-	-	-	-	-	-
185037	Folding seat frame assembly .....	-	-	2	2	-	-	-	-	-	-
5580	Screw No. 10-32 x 1" flat hd. ....	-	-	16	16	-	-	-	-	-	-
5229	Screw 1/4-28 x 1-3/8" flat hd. ....	-	-	8	8	-	-	-	-	-	-
8220	Screw 1/4-28 x 1-1/2" flat hd. ....	-	-	8	8	-	-	-	-	-	-
7003	Nut No. 10-32 .....	-	-	16	16	-	-	-	-	-	-
7004	Nut 1/4-28 /.....	-	-	16	16	-	-	-	-	-	-
3867	Washer 3/16" .....	-	-	4	4	-	-	-	-	-	-
185111	Folding seat frame side-left .....	-	-	2	2	-	-	-	-	-	-
185118	Folding seat frame side-right .....	-	-	2	2	-	-	-	-	-	-
187774	Folding seat handle .....	-	-	2	2	-	-	-	-	-	-
100100	Folding seat pivot pin .....	-	-	4	4	-	-	-	-	-	-
187421	Folding seat pivot pin retainer .....	-	-	2	2	-	-	-	-	-	-
8204	Screw 1/4-28 x 2" flat hd. ....	-	-	4	4	-	-	-	-	-	-
206919	Folding seat support-left .....	-	-	2	2	-	-	-	-	-	-
206920	Folding seat support-right .....	-	-	2	2	-	-	-	-	-	-
185114	Folding seat support to seat frame screw .	-	-	4	4	-	-	-	-	-	-
7006	Nut 3/8-24 .....	-	-	4	4	-	-	-	-	-	-
5506	Lockwasher 3/8" .....	-	-	4	4	-	-	-	-	-	-

Piece No.	Name	No. Required										
		732	733	734	735	736	737	738	739	743	747	
<b>FOOT REST</b>												
206140	Foot rest assembly .....	-	1	1	1	-	-	-	-	-	-	-
79574	Foot rest assembly .....	-	-	-	-	-	-	1	1	-	-	-
8013	Screw No. 10-32 x 1-1/8" oval hd. mach. ....	-	4	4	4	-	-	-	-	-	-	-
206133	Foot rest bar .....	-	1	1	1	-	-	-	-	-	-	-
206134	Foot rest bar cushion .....	-	1	1	1	-	-	-	-	-	-	-
206136	Foot rest bar end bracket left .....	-	1	1	1	-	-	-	-	-	-	-
206090	Foot rest bar end bracket right .....	-	1	1	1	-	-	-	-	-	-	-
206139	Foot rest bar end to support screw .....	-	2	2	2	-	-	-	-	-	-	-
195201	Foot rest bar end to support screw washer. 6048 Lockwasher 3/8" Shakeproof .....	-	2	2	2	-	-	-	-	-	-	-
122146	Foot rest pivot stud .....	-	-	-	-	-	-	2	2	-	-	-
180134	Nut-blind .....	-	-	-	-	-	-	2	2	-	-	-
206143	Foot rest support .....	-	2	2	2	-	-	-	-	-	-	-
147114	Foot rest support bracket .....	-	-	-	-	-	-	2	2	-	-	-
206141	Foot rest support bracket .....	-	2	2	2	-	-	-	-	-	-	-
214561	Foot rest support bracket screw .....	-	2	2	2	-	-	-	-	-	-	-
206130	Foot rest support bracket cushion .....	-	2	2	2	-	-	-	-	-	-	-
206132	Foot rest support cushion .....	-	2	2	2	-	-	-	-	-	-	-

## FRONT SEAT

122611	Front seat back compartment door hinge ...	-	-	-	-	-	-	3	2	-	-	-
114525	Front seat back compartment lid lifter ...	-	-	-	-	-	-	1	1	-	-	-
212709	Front seat left-back spring .....	-	1	1	-	1	-	-	-	-	-	-
214827	Front seat left-back spring .....	-	-	-	-	-	-	1	1	-	-	-
214697	Front seat back spring .....	-	-	-	1	-	-	-	-	-	-	-
195249	Front seat back spring .....	-	-	-	-	-	2	-	-	-	-	-
214727	Front seat back spring .....	1	-	-	-	-	-	-	-	-	-	-
212711	Front seat right-back spring .....	-	1	1	-	1	-	-	-	-	-	-
214833	Front seat right-back spring .....	-	-	-	-	-	-	1	1	-	-	-
199749	Front seat compartment bottom battery cover assembly .....	-	-	-	-	-	-	1	1	1	-	-
212695	Front seat compartment bottom battery cover assembly .....	1	1	1	1	1	-	-	-	-	-	-
212690	Front seat compartment bottom battery cover clamp .....	2	2	2	2	2	-	-	-	-	-	-
5687	Screw 1/4-28 x 5/8" rnd. hd. ....	2	2	2	2	2	-	-	-	-	-	-
199045	Front seat compartment bottom battery cover clamp screw clinch nut 1/4-28 thd.	2	2	2	2	2	-	-	-	-	-	-
212691	Front seat compartment bottom battery cover gasket .....	1	1	1	1	1	-	-	-	-	-	-
181695	Front seat right-counterbalance assembly .	-	-	-	-	-	1	-	-	-	-	-
5823	Screw 1/4-28 x 1-1/8" oval hd. ....	-	-	-	-	-	3	-	-	-	-	-
5502	Lockwasher 1/4" std. ....	-	-	-	-	-	3	-	-	-	-	-
7004	Nut 1/4-28 .....	-	-	-	-	-	3	-	-	-	-	-
62065	Washer 1/4" special .....	-	-	-	-	-	3	-	-	-	-	-
181703	Front seat right-counterbalance spring left .....	-	-	-	-	-	1	-	-	-	-	-
181702	Front seat right-counterbalance spring right .....	-	-	-	-	-	1	-	-	-	-	-
181989	Front seat right-counterbalance spring adjusting lever .....	-	-	-	-	-	2	-	-	-	-	-
181697	Front seat right-counterbalance spring lever and pin assembly .....	-	-	-	-	-	1	-	-	-	-	-
5822	Front seat right-counterbalance spring adjusting lever screw 1/4-28 x 5/8" hex. hd. ....	-	-	-	-	-	2	-	-	-	-	-

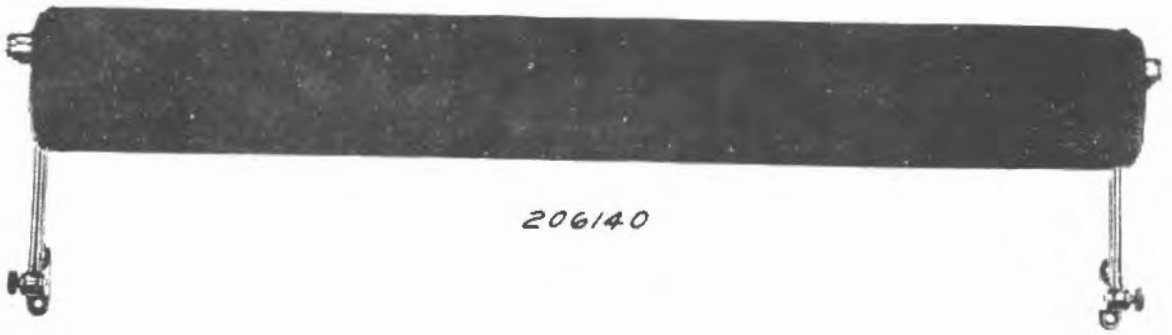

206140



206132



206130



206141



214561



147114



122146

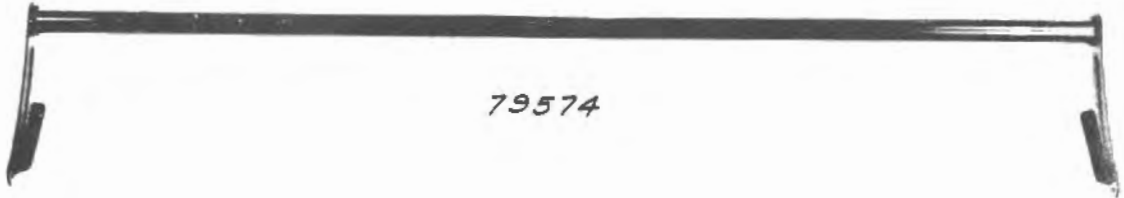

79574

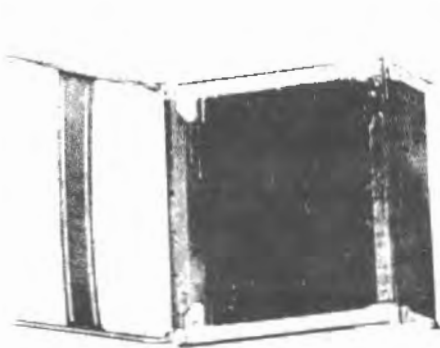

206921



212342



212343





SERVICE PARTS LIST—PACKARD TWELVE

Golf Compartment 347

Piece No.	Name	No. Required												
		732	733	734	735	736	737	738	739	743	747			
5502	Lockwasher 1/4" std. ....	-	-	-	-	-	2	-	-	-	-	-	-	-
7004	Nut 1/4"-28 .....	-	-	-	-	-	2	-	-	-	-	-	-	-
NOTE:--Always send samples of material when ordering cushion assemblies, as the assemblies are upholstered to match the body interior.														
214665	Front seat cushion assembly .....	-	-	-	1	-	-	-	-	-	-	-	-	-
214663	Front seat cushion assembly .....	1	-	-	-	-	-	-	-	-	-	-	-	-
214849	Front seat left-cushion assembly .....	-	-	-	-	-	-	-	1	-	-	-	-	-
214645	Front seat left-cushion assembly .....	-	1	1	-	1	-	-	-	-	-	-	-	-
214651	Front seat left-cushion assembly .....	-	-	-	-	-	-	1	-	-	-	-	-	-
214671	Front seat left-cushion assembly .....	-	-	-	-	-	-	1	-	-	-	-	-	-
214851	Front seat right-cushion assembly .....	-	-	-	-	-	-	-	1	-	-	-	-	-
214650	Front seat right-cushion assembly .....	-	-	-	-	-	-	1	-	-	-	-	-	-
214644	Front seat right-cushion assembly .....	-	1	1	-	1	-	-	-	-	-	-	-	-
214670	Front seat right-cushion assembly .....	-	-	-	-	-	1	-	-	-	-	-	-	-
181141	Front seat cushion dowel female .....	4	4	4	2	4	-	4	4	-	2	-	-	-
181036	Front seat cushion dowel male .....	4	4	4	2	4	-	4	4	-	2	-	-	-
214698	Front seat cushion spring .....	1	-	-	1	-	-	-	-	-	-	-	-	-
214730	Front seat right-cushion spring .....	-	-	-	-	-	1	-	-	-	-	-	-	-
214729	Front seat left-cushion spring .....	-	-	-	-	-	1	-	-	-	-	-	-	-
212377	Front seat left-cushion spring .....	-	1	1	-	1	-	-	-	-	-	-	-	-
214813	Front seat left-cushion spring .....	-	-	-	-	-	-	1	1	-	-	-	-	-
212376	Front seat right-cushion spring .....	-	1	1	-	1	-	-	-	-	-	-	-	-
214814	Front seat right-cushion spring .....	-	-	-	-	-	-	1	1	-	-	-	-	-
173149	Front seat hinge .....	-	-	-	-	-	2	-	-	-	-	-	-	-
7610	Bolt 1/4"-28 x 2-1/8" carriage .....	-	-	-	-	-	8	-	-	-	-	-	-	-
5817	Lockwasher 1/4" Shakeproof .....	-	-	-	-	-	8	-	-	-	-	-	-	-
7004	Nut 1/4"-28 .....	-	-	-	-	-	8	-	-	-	-	-	-	-
181686	Front seat left-lever ratchet .....	-	-	-	-	-	1	-	-	-	-	-	-	-
173150	Front seat left-locking lever .....	-	-	-	-	-	1	-	-	-	-	-	-	-
173513	Front seat left-locking lever pin .....	-	-	-	-	-	1	-	-	-	-	-	-	-
173313	Front seat left-locking lever spring ..	-	-	-	-	-	1	-	-	-	-	-	-	-
187739	Front seat left-locking spring .....	-	-	-	-	-	1	1	1	-	-	-	-	-
214717	Front seat left-operating button spring ..	-	1	1	-	1	-	-	-	-	-	-	-	-
212972	Front seat left-operating cable assembly .	-	1	1	-	1	-	-	-	-	-	-	-	-
8208	Screw No. 10-32 x 3/8" flat hd. ....	-	4	4	-	4	-	-	-	-	-	-	-	-
7003	Nut No. 10-32 .....	-	4	4	-	4	-	-	-	-	-	-	-	-
7901	Front seat left-operating cable assembly attaching screw No. 10 x 5/8" rnd. hd. .	-	1	1	-	1	-	-	-	-	-	-	-	-
187736	Front seat left-operating handle assembly.	-	-	-	-	-	-	1	1	1	-	-	-	-
146103	Spring .....	-	-	-	-	-	-	1	1	1	-	-	-	-
3912	Washer 7/16" .....	-	-	-	-	-	-	1	1	1	-	-	-	-
4290	Pin 3/32" x 5/8" spring cotter .....	-	-	-	-	-	-	1	1	1	-	-	-	-
5502	Lockwasher 1/4" std. ....	-	-	-	-	-	-	1	1	1	-	-	-	-
7004	Nut 1/4"-28 .....	-	-	-	-	-	-	1	1	1	-	-	-	-
212849	Front seat left support operating mechanism-left .....	-	1	1	-	1	-	-	-	-	-	-	-	-
212848	Front seat left support operating mechanism-right .....	-	1	1	-	1	-	-	-	-	-	-	-	-
199718	Front seat left-operating spring .....	-	1	1	-	1	-	1	1	1	-	-	-	-

GOLF COMPARTMENT

193310	Golf compartment door trimmed assembly ...	-	-	-	-	-	-	1	1	-	-	-	-	-
111671	Golf compartment door bumper .....	-	-	-	-	-	-	2	2	-	-	-	-	-
111672	Golf compartment door bumper socket .....	-	-	-	-	-	-	2	2	-	-	-	-	-

Piece No.	Name	No. Required									
		732	733	734	735	736	737	738	739	743	747
163766	Golf compartment door hinge .....	-	-	-	-	-	-	1	1	-	-
163767	Golf compartment door lock .....	-	-	-	-	-	-	1	1	-	-
143615	Golf compartment door lock striker .....	-	-	-	-	-	-	1	1	-	-

## HAND BRAKE CUTOUT COVER

204455	Hand brake lever cutout cover .....	1	1	1	1	1	1	1	1	1	1
--------	-------------------------------------	---	---	---	---	---	---	---	---	---	---

## HASSOCK

135807	Hassock .....	2	-	-	-	2	-	-	-	-	-
--------	---------------	---	---	---	---	---	---	---	---	---	---

## MOULDING

218438	Moulding cowl rail finishing .....	-	-	-	-	-	-	-	-	1	1
214319	Moulding cowl rail finishing assembly ....	-	-	-	-	-	-	1	1	-	-
212979	Moulding cowl rail finishing ash receiver.	-	-	-	-	-	-	1	1	1	1
214714	Moulding door window finishing right asb..	-	-	-	-	-	-	1	1	-	-
218439	Moulding door window finishing right .....	-	-	-	-	-	-	-	-	-	1
214713	Moulding door window finishing left asb. .	-	-	-	-	-	-	1	1	-	-
218440	Moulding door window finishing left .....	-	-	-	-	-	-	-	-	-	1
218441	Moulding door window finishing front right	-	-	-	-	-	-	-	-	-	1
214370	Moulding door window finishing front right assembly .....	-	1	-	-	1	1	-	-	-	-
212876	Moulding door window finishing front right assembly .....	1	-	1	1	-	-	-	-	-	-
214369	Moulding door window finishing front left assembly .....	-	1	-	-	1	1	-	-	-	-
218442	Moulding door window finishing front left.	-	-	-	-	-	-	-	-	1	-
212875	Moulding door window finishing front left assembly .....	1	-	1	1	-	-	-	-	-	-
218757	Moulding door window finishing front screw No. 8 x 1-3/4" Parker Kalon oval head .....	2	2	2	2	2	2	-	-	-	-
218759	Screw No. 8 x 7/8" Parker Kalon oval head .....	2	2	2	2	2	2	-	-	-	-
218758	Screw No. 8 x 1-1/8" Parker Kalon oval head .....	2	2	2	2	2	2	-	-	-	-
212968	Moulding door window finishing rear right.	1	-	1	1	-	-	-	-	-	-
214324	Moulding door window finishing rear right assembly .....	-	1	-	-	1	-	-	-	-	-
218443	Moulding door window finishing rear right.	-	-	-	-	-	-	-	-	1	-
218444	Moulding door window finishing rear left .	-	-	-	-	-	-	-	-	1	-
212969	Moulding door window finishing rear left assembly .....	1	-	1	1	-	-	-	-	-	-
214323	Moulding door window finishing rear left assembly .....	-	1	-	-	1	-	-	-	-	-
212052	Moulding-drip 72" long .....	2	-	-	-	-	-	-	-	-	-
214383	Moulding-drip 122" long .....	-	-	-	-	-	-	1	-	-	-
214680	Moulding partition window finishing asb. .	-	-	-	1	-	-	-	-	-	-
166426	Moulding-rear platform 44-1/2" long .....	-	-	-	-	1	-	-	-	-	-
214313	Moulding-rear window finishing .....	-	1	1	1	1	1	-	-	-	-
212049	Moulding-rear window finishing .....	1	-	-	-	-	-	-	-	-	-
206144	Moulding-rear window finishing assembly ..	-	-	-	-	-	-	1	-	-	-
204842	Moulding roof joint 78" long .....	-	-	-	-	-	-	2	-	-	-
204837	Moulding roof joint 122-1/2" long .....	-	2	-	-	-	-	-	-	-	-
204841	Moulding roof joint 99" long .....	-	-	-	-	-	2	-	-	-	-

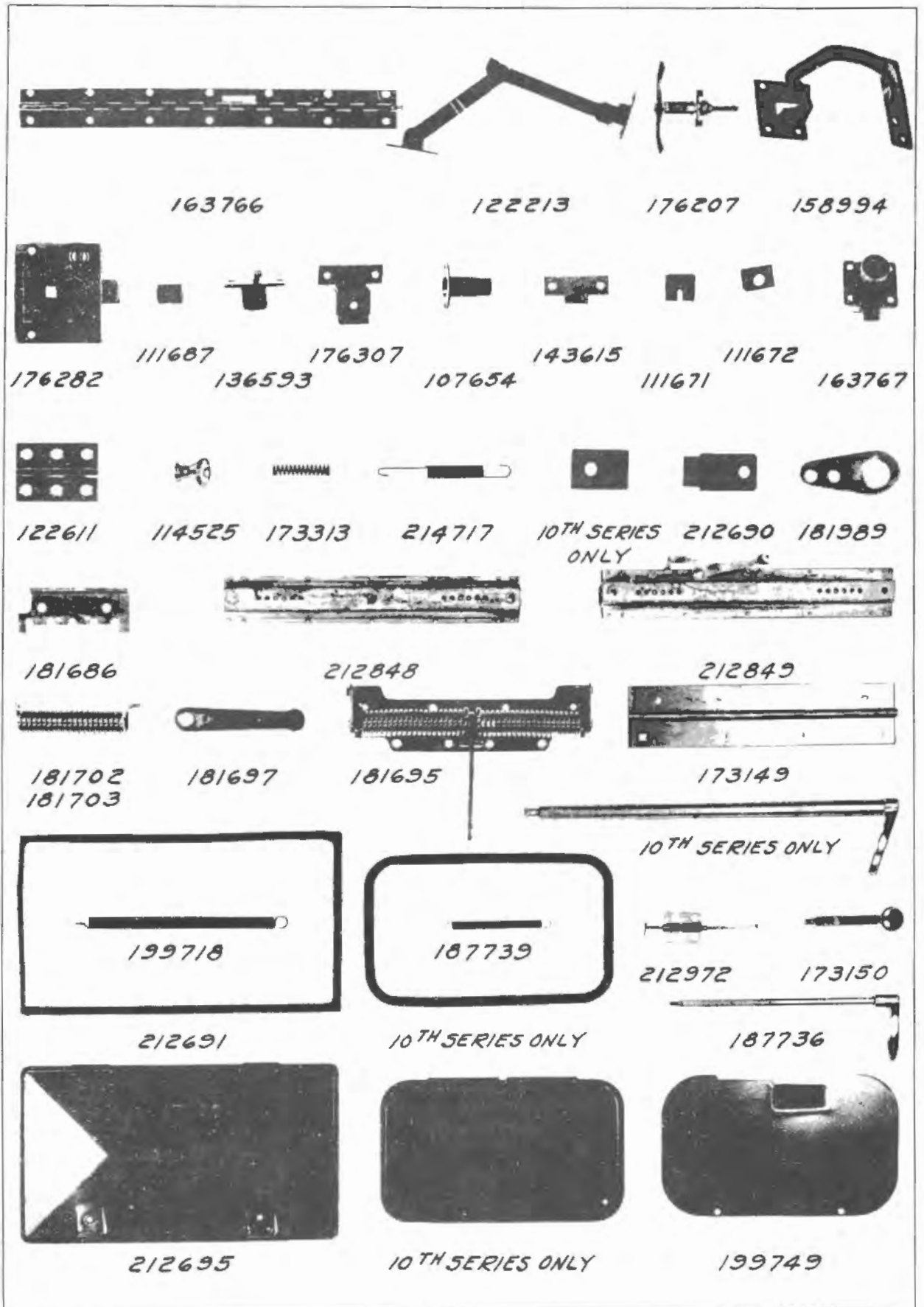

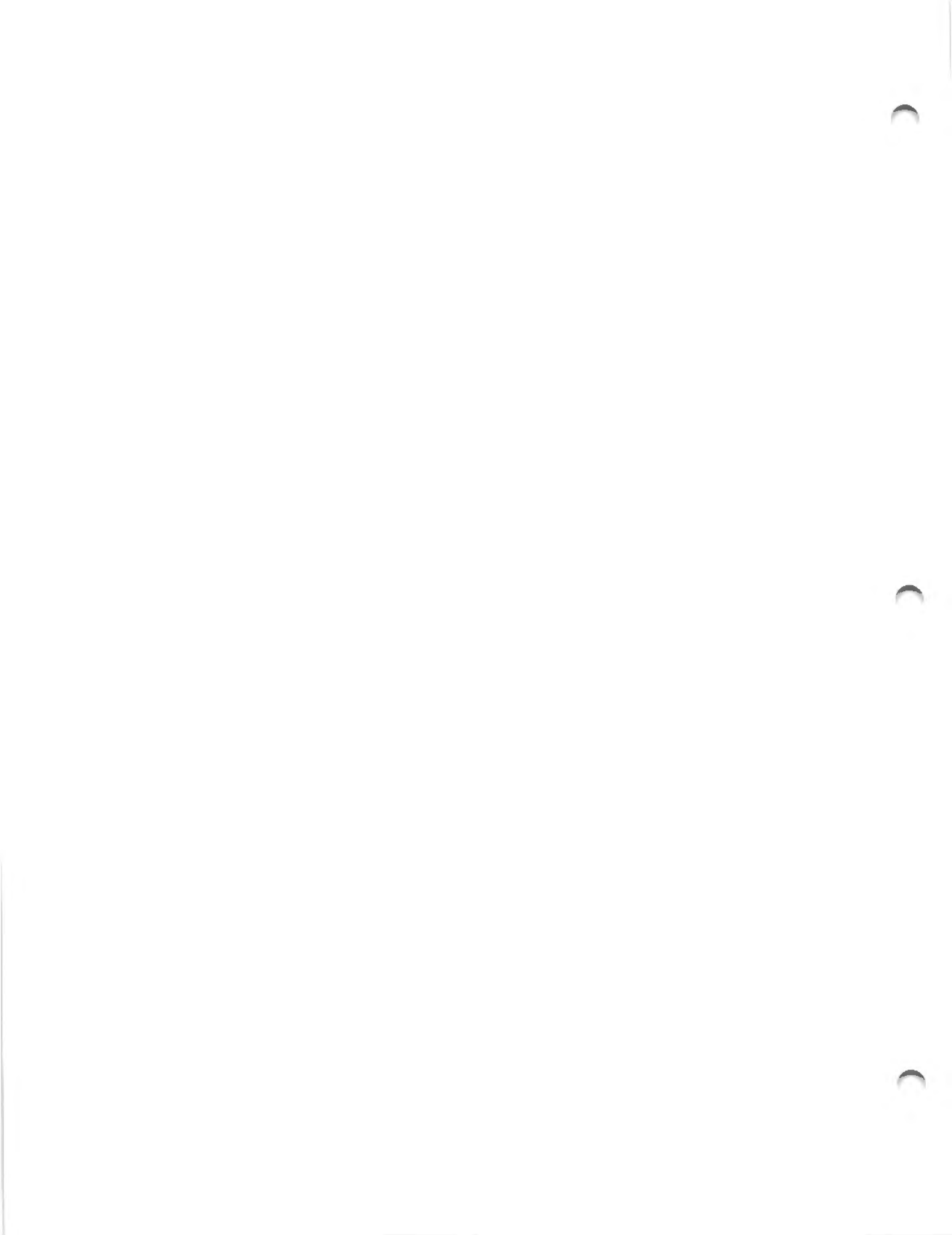

Part No.	Name	No. Required												
		742	743	751	755	736	737	738	739	743	747			
212050	Moulding roof joint 60" long .....	1	-	-	-	-	-	-	-	-	-	-	-	-
204839	Moulding roof joint 134-1/2" long .....	-	-	2	2	-	-	-	-	-	-	-	-	-
204840	Moulding roof joint 113-1/2" long .....	-	-	-	-	2	-	-	-	-	-	-	-	-
214371	Moulding side window finishing right asb..	-	1	-	-	-	-	-	-	-	-	-	-	-
214317	Moulding side window finishing right asb..	-	-	1	1	-	-	-	-	-	-	-	-	-
214510	Moulding side window finishing right asb..	-	-	-	-	-	1	-	-	-	-	-	-	-
214511	Moulding side window finishing left asb. .	-	-	-	-	-	1	-	-	-	-	-	-	-
214372	Moulding side window finishing left asb. .	-	1	-	-	-	-	-	-	-	-	-	-	-
214316	Moulding side window finishing left asb. .	-	-	1	1	-	-	-	-	-	-	-	-	-
214397	Moulding windshield header assembly .....	1	1	1	1	1	1	-	-	-	-	-	-	-
5497	Screw No. 10-32 x 1/2" oval hd. ....	2	2	2	2	2	2	-	-	-	-	-	-	-
185676	Screw ferrule No. 10 std. ....	2	2	2	2	2	2	-	-	-	-	-	-	-
214302	Moulding windshield opening assembly .....	1	1	1	1	1	1	-	-	-	-	-	-	-
5739	Moulding windshield opening screw No. 10- 32 x 1/2" hex. hd. ....	6	6	6	6	6	6	-	-	-	-	-	-	-
6056	Lockwasher 3/16" (Shakeproof) .....	6	6	6	6	6	6	-	-	-	-	-	-	-
212976	Moulding windshield opening ash receiver (Supersedes 214447) .....	1	1	1	1	1	1	-	-	-	-	-	-	-

PANEL

214301	Panel cowl assembly .....	1	-	-	-	-	-	-	-	-	-	-	-	-
212984	Panel cowl assembly .....	-	1	1	1	1	1	-	-	-	-	-	-	-
212986	Panel cowl assembly .....	-	-	-	-	-	-	1	1	1	1	1	1	1
212993	Panel dash assembly .....	-	-	-	-	-	-	-	1	1	1	1	1	1
212991	Panel dash assembly .....	1	1	1	1	1	1	-	-	-	-	-	-	-
212995	Panel dash cover assembly .....	1	1	1	1	1	1	-	-	-	-	-	-	-
212997	Panel dash cover assembly .....	-	-	-	-	-	-	1	1	1	1	1	1	1
212877	Panel dash inter-liner .....	1	1	1	1	1	1	-	-	-	-	-	-	-
212878	Panel dash inter-liner .....	-	-	-	-	-	-	1	1	1	1	1	1	1
212879	Panel dash liner .....	1	1	1	1	1	1	-	-	-	-	-	-	-
212978	Panel dash liner .....	-	-	-	-	-	-	-	1	1	1	1	1	1
212420	Panel door right assembly .....	-	-	-	-	-	-	-	-	-	-	-	-	1
195692	Panel door right assembly .....	-	-	-	-	-	-	1	1	-	-	-	-	-
195691	Panel door left assembly .....	-	-	-	-	-	-	1	1	-	-	-	-	-
212421	Panel door left assembly .....	-	-	-	-	-	-	-	-	-	-	-	-	1
212812	Panel door front right assembly .....	-	1	-	-	1	1	-	-	-	-	-	-	-
212422	Panel door front right assembly .....	-	-	-	-	-	-	-	-	-	-	1	-	-
212800	Panel door front right assembly .....	1	-	1	1	-	-	-	-	-	-	-	-	-
212813	Panel door front left assembly .....	-	1	-	-	1	1	-	-	-	-	-	-	-
212423	Panel door front left assembly .....	-	-	-	-	-	-	-	-	-	-	1	-	-
212801	Panel door front left assembly .....	1	-	1	1	-	-	-	-	-	-	-	-	-
212824	Panel door rear right assembly .....	-	-	-	-	1	-	-	-	-	-	-	-	-
212424	Panel door rear right assembly .....	-	-	-	-	-	-	-	-	-	-	1	-	-
212814	Panel door rear right assembly .....	-	1	-	-	-	-	-	-	-	-	-	-	-
212808	Panel door rear right assembly .....	1	-	-	-	-	-	-	-	-	-	-	-	-
212802	Panel door rear right assembly .....	-	-	1	1	-	-	-	-	-	-	-	-	-
212803	Panel door rear left assembly .....	-	-	1	1	-	-	-	-	-	-	-	-	-
212815	Panel door rear left assembly .....	-	1	-	-	-	-	-	-	-	-	-	-	-
212809	Panel door rear left assembly .....	1	-	-	-	-	-	-	-	-	-	-	-	-
212825	Panel door rear left assembly .....	-	-	-	-	1	-	-	-	-	-	-	-	-
212425	Panel door rear left assembly .....	-	-	-	-	-	-	-	-	-	-	1	-	-
187890	Panel golf compartment door .....	-	-	-	-	-	-	1	1	-	-	-	-	-
171001	Panel rear compartment door .....	-	-	-	-	-	-	1	-	-	-	-	-	-
204905	Panel rear deck and side assembly .....	-	-	-	-	-	-	-	1	1	-	-	-	-
187744	Panel rumble seat compartment door .....	-	-	-	-	-	-	-	1	1	-	-	-	-

Piece No.	Name	No. Required									
		732	733	734	735	736	737	738	739	743	747
<b>REAR COMPARTMENT</b>											
173312	Rear compartment door assembly .....	-	-	-	-	-	1	-	-	-	-
122213	Rear compartment door brace assembly .....	-	-	-	-	-	1	-	-	-	-
5676	Screw No. 10-32 x 3/8" rnd. hd. ....	-	-	-	-	-	1	-	-	-	-
5500	Lockwasher No. 10 std. ....	-	-	-	-	-	1	-	-	-	-
7003	Nut No. 10-32 .....	-	-	-	-	-	1	-	-	-	-
111687	Rear compartment door bumper .....	-	-	-	-	-	2	-	-	-	-
172133	Rear compartment door drain gutter asb. ..	-	-	-	-	-	1	-	-	-	-
158994	Rear compartment door hinge .....	-	-	-	-	-	2	-	-	-	-
5684	Bolt 1/4"-28 x 1-7/8" carriage .....	-	-	-	-	-	4	-	-	-	-
5502	Lockwasher 1/4" std. ....	-	-	-	-	-	4	-	-	-	-
7004	Nut 1/4"-28 .....	-	-	-	-	-	4	-	-	-	-
102590	Rear compartment light bulb 7 V. 3 CP G-6. single contact .....	-	-	-	-	-	1	-	-	-	-
107654	Rear compartment light disconnecter plug socket .....	-	-	-	-	-	1	-	-	-	-
176677	Rear compartment light to ground cable assembly .....	-	-	-	-	-	1	-	-	-	-
136593	Rear compartment light switch (2 point) ..	-	-	-	-	-	1	-	-	-	-
33287	Rear compartment light switch cable terminal 13/64" eye .....	-	-	-	-	-	1	-	-	-	-
176282	Rear compartment door lock .....	-	-	-	-	-	1	-	-	-	-
176207	Rear compartment door lock handle (with key lock) .....	-	-	-	-	-	1	-	-	-	-
8018	Screw No. 8-32 x 7/8" oval hd. ....	-	-	-	-	-	1	-	-	-	-
184249	Rear compartment door lock handle screw washer .....	-	-	-	-	-	1	-	-	-	-
5581	Lockwasher 5/32" countersunk .....	-	-	-	-	-	1	-	-	-	-
176307	Rear compartment door lock striker .....	-	-	-	-	-	1	-	-	-	-
187828	Rear compartment door weatherstrip long ..	-	-	-	-	-	2	-	-	-	-
187829	Rear compartment door weatherstrip short ..	-	-	-	-	-	2	-	-	-	-

### REAR QUARTER LIGHT

214891	Rear quarter light .....	2	2	2	2	2	2	-	-	-	-
5868	Screw No. 10-32 x 5/8" flat hd. ....	2	2	2	2	2	2	-	-	-	-
102590	Rear quarter light bulb 7V. 3 CP G-6 single contact .....	2	2	2	2	2	2	-	-	-	-
214890	Rear quarter light finishing moulding ....	2	2	2	2	2	2	-	-	-	-
214892	Rear quarter light glass and rim .....	2	2	2	2	2	2	-	-	-	-
183836	Rear quarter light reflector .....	2	2	2	2	2	2	-	-	-	-
183843	Rear quarter light switch .....	1	1	1	1	1	1	-	-	-	-

### REAR SEAT

214607	Rear seat back spring left .....	-	-	-	-	-	1	-	-	-	-
212611	Rear seat back spring left .....	-	-	1	1	-	-	-	-	-	-
214592	Rear seat back spring left .....	1	1	-	-	-	-	-	-	-	-
214605	Rear seat back spring left .....	-	-	-	-	1	-	-	-	-	-
212610	Rear seat back spring right .....	-	-	1	1	-	-	-	-	-	-
214591	Rear seat back spring right .....	1	1	-	-	-	-	-	-	-	-
214604	Rear seat back spring right .....	-	-	-	-	1	-	-	-	-	-
214606	Rear seat back spring right .....	-	-	-	-	-	1	-	-	-	-

NOTE:--Always send samples of material when ordering cushion assemblies, as the assemblies are upholstered to match the body interior.



Piece No	Name	No. Required										
		732	733	734	735	736	737	738	739	743	747	
214584	Rear seat cushion assembly .....	-	-	1	1	-	-	-	-	-	-	-
214587	Rear seat cushion assembly .....	1	1	-	-	-	-	-	-	-	-	-
181141	Rear seat cushion dowel female .....	2	2	2	2	2	-	-	-	-	-	-
214590	Rear seat cushion assembly .....	-	-	-	-	1	-	-	-	-	-	-
214615	Rear seat cushion assembly .....	-	-	-	-	-	1	-	-	-	-	-
212612	Rear seat cushion spring .....	-	-	1	1	-	-	-	-	-	-	-
214474	Rear seat cushion spring .....	1	1	-	-	-	-	-	-	-	-	-
214616	Rear seat cushion spring .....	-	-	-	-	-	1	-	-	-	-	-
214617	Rear seat cushion spring .....	-	-	-	-	1	-	-	-	-	-	-

REAR VIEW MIRROR

193462	Rear view mirror assembly .....	-	-	-	-	-	-	1	1	1	1
212283	Rear view mirror assembly .....	1	1	1	1	1	1	-	-	-	-
5631	Screw No. 10-32 x 1/4" rnd. ....	-	-	-	-	-	-	-	2	2	2
5497	Screw No. 10-32 x 1/2" oval hd. ....	2	2	2	2	2	2	2	-	-	-
191368	Rear view mirror glass .....	-	-	-	-	-	-	1	1	-	-

ROBE RAIL

204999	Robe rail assembly .....	-	1	1	1	1	-	-	-	-	-
206710	Robe rail attaching plate spring .....	-	2	2	2	2	-	-	-	-	-

RUMBLE SEAT

193069	Rumble seat back spring .....	-	-	-	-	-	-	1	1	-	-
157018	Rumble seat compartment door bumper .....	-	-	-	-	-	-	2	2	-	-
187730	Rumble seat compartment door hinge right ..	-	-	-	-	-	-	1	1	-	-
187729	Rumble seat compartment door hinge left ..	-	-	-	-	-	-	1	1	-	-
7604	Bolt 1/4-28 x 1-5/8" carriage .....	-	-	-	-	-	-	6	6	-	-
7004	Nut 1/4-28 .....	-	-	-	-	-	-	6	6	-	-
5502	Lockwasher 1/4" std. ....	-	-	-	-	-	-	6	6	-	-
187727	Rumble seat compartment door hinge bracket right .....	-	-	-	-	-	-	1	1	-	-
187728	Rumble seat compartment door hinge bracket left .....	-	-	-	-	-	-	1	1	-	-
7613	Bolt 1/4-28 x 1-3/4" carriage .....	-	-	-	-	-	-	4	4	-	-
5502	Lockwasher 1/4" std. ....	-	-	-	-	-	-	4	4	-	-
7004	Nut 1/4-28 .....	-	-	-	-	-	-	4	4	-	-
8222	Screw 3/8-24 x 1" flat hd. ....	-	-	-	-	-	-	4	4	-	-
5506	Lockwasher 3/8" .....	-	-	-	-	-	-	4	4	-	-
7006	Nut 3/8-24 .....	-	-	-	-	-	-	4	4	-	-
196243	Rumble seat compartment door operating spring .....	-	-	-	-	-	-	2	2	-	-
157584	Rumble seat compartment door operating bolt .....	-	-	-	-	-	-	2	2	-	-
7104	Nut 1/4-28 castle .....	-	-	-	-	-	-	2	2	-	-
4280	Cotter pin 1/16 x 1/2" .....	-	-	-	-	-	-	2	2	-	-
157585	Rumble seat compartment door operating spring washer .....	-	-	-	-	-	-	2	2	-	-
127501	Rumble seat compartment door hinge bushing ..	-	-	-	-	-	-	2	2	-	-
127498	Rumble seat compartment door hinge screw ..	-	-	-	-	-	-	2	2	-	-
3884	Washer 1/2" "N" std. ....	-	-	-	-	-	-	2	2	-	-
5510	Lockwasher 1/2" std. ....	-	-	-	-	-	-	2	2	-	-
157625	Rumble seat compartment door lock striker ..	-	-	-	-	-	-	1	1	-	-
187773	Rumble seat compartment drain gutter asb..	-	-	-	-	-	-	1	1	-	-
102590	Rumble seat compartment light bulb 7 V 3 CP G-6 single contact .....	-	-	-	-	-	-	1	1	-	-

Piece No	Name	No. Required									
		732	733	734	735	736	737	738	739	743	747
107654	Rumble seat compartment light disconnecter plug socket .....	-	-	-	-	-	-	1	1	-	-
176683	Rumble seat compartment light to ground cable assembly .....	-	-	-	-	-	-	-	1	-	-
176077	Rumble seat compartment light to instrument board cigar lighter cable assembly.	-	-	-	-	-	-	-	1	-	-
136593	Rumble seat compartment light switch (2 point) .....	-	-	-	-	-	-	1	1	-	-
204197	Rumble seat cushion assembly (Furnish sample of material) .....	-	-	-	-	-	-	1	1	-	-
204264	Rumble seat cushion spring .....	-	-	-	-	-	-	1	1	-	-
204552	Rumble seat door lock assembly .....	-	-	-	-	-	-	1	1	-	-
193062	Rumble seat door lock operating cable asb.	-	-	-	-	-	-	1	1	-	-
7513	Yoke end adj. 3/16" .....	-	-	-	-	-	-	1	1	-	-
7523	Yoke end pin 3/16" .....	-	-	-	-	-	-	1	1	-	-
3906	Washer 3/16" "Y" std. ....	-	-	-	-	-	-	2	2	-	-
4690	Pin 1/16 x 3/8" spring cotter .....	-	-	-	-	-	-	1	1	-	-
195687	Rumble seat door lock operating cable assembly clip .....	-	-	-	-	-	-	3	3	-	-
8207	Rumble seat door lock operating cable assembly clip screw No. 10-32 x 3/4" flat hd. ....	-	-	-	-	-	-	1	1	-	-
5500	Lockwasher No. 10 std. ....	-	-	-	-	-	-	1	1	-	-
7003	Nut No. 10-32 .....	-	-	-	-	-	-	1	1	-	-
193063	Rumble seat door lock operating handle ...	-	-	-	-	-	-	1	1	-	-
214770	Rumble seat step lower assembly (Used with rear wheel carrier) .....	-	-	-	-	-	-	1	1	-	-
214772	Rumble seat step lower assembly (Used with side wheel carrier) .....	-	-	-	-	-	-	1	1	-	-
175144	Rumble seat step lower clamp plate .....	-	-	-	-	-	-	2	2	-	-
7859	Screw 1/4-28 x 1-1/2" hex. hd. ....	-	-	-	-	-	-	2	2	-	-
7842	Screw 1/4-28 x 1-1/4" hex. hd. ....	-	-	-	-	-	-	2	2	-	-
5502	Lockwasher 1/4" std. ....	-	-	-	-	-	-	4	4	-	-
7004	Nut 1/4-28 .....	-	-	-	-	-	-	4	4	-	-
214768	Rumble seat step lower linoleum (Used with rear wheel carrier) .....	-	-	-	-	-	-	1	1	-	-
214753	Rumble seat step lower linoleum (Used with side wheel carrier) .....	-	-	-	-	-	-	1	1	-	-
206729	Rumble seat step upper assembly .....	-	-	-	-	-	-	1	1	-	-
6116	Stud 3/8" std. ....	-	-	-	-	-	-	3	3	-	-
114055	Washer 25/64 x 3/4 x 5/32 plain .....	-	-	-	-	-	-	3	3	-	-
5506	Lockwasher 3/8" std. ....	-	-	-	-	-	-	3	3	-	-
7006	Nut 3/8-24 .....	-	-	-	-	-	-	3	3	-	-
7811	Screw 5/16-24 x 1-3/8" hex. hd. ....	-	-	-	-	-	-	2	2	-	-
5504	Lockwasher 5/16" std. ....	-	-	-	-	-	-	2	2	-	-
179123	Rumble seat step upper liner .....	-	-	-	-	-	-	1	1	-	-
204938	Rumble seat step upper linoleum .....	-	-	-	-	-	-	1	1	-	-
214443	Rumble seat step upper bracket .....	-	-	-	-	-	-	1	1	-	-
214444	Rumble seat step upper bracket gasket ....	-	-	-	-	-	-	1	1	-	-

## SMOKING CASE

214531	Smoking case assembly-left .....	1	-	-	-	1	-	-	-	-	-
214532	Smoking case assembly-right .....	1	-	-	-	1	-	-	-	-	-
214887	Smoking case-left .....	-	-	1	1	-	-	-	-	-	-
214888	Smoking case-right .....	-	-	1	1	-	-	-	-	-	-
214620	Smoking case ash receiver .....	2	-	2	2	2	-	-	-	-	-
214447	Smoking case ash receiver .....	-	-	-	-	2	-	-	-	-	-
199923	Smoking case cigar lighter .....	2	-	2	2	2	-	-	1	2	-
214563	Smoking case cigar lighter complete .....	2	-	-	-	2	-	-	-	1	2



193063



127498



196243



157585



157584



175144



10TH SERIES ONLY



107654



136593



204552



10TH SERIES ONLY



157625



157018



214772



10TH SERIES ONLY



214770



206729

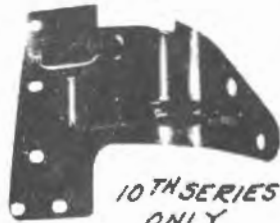

10TH SERIES ONLY



214443



10TH SERIES ONLY



179123



187729-187730



214444



187727-187728





206886 - 215791  
206887 - 215792



180646



180645



180647

185031 127502

212283



10TH SERIES ONLY

193462



212324 212435 212280 212297

212436

212298



10TH SERIES ONLY

179077



212974-212975

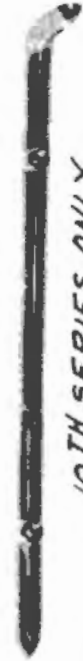

10TH SERIES ONLY

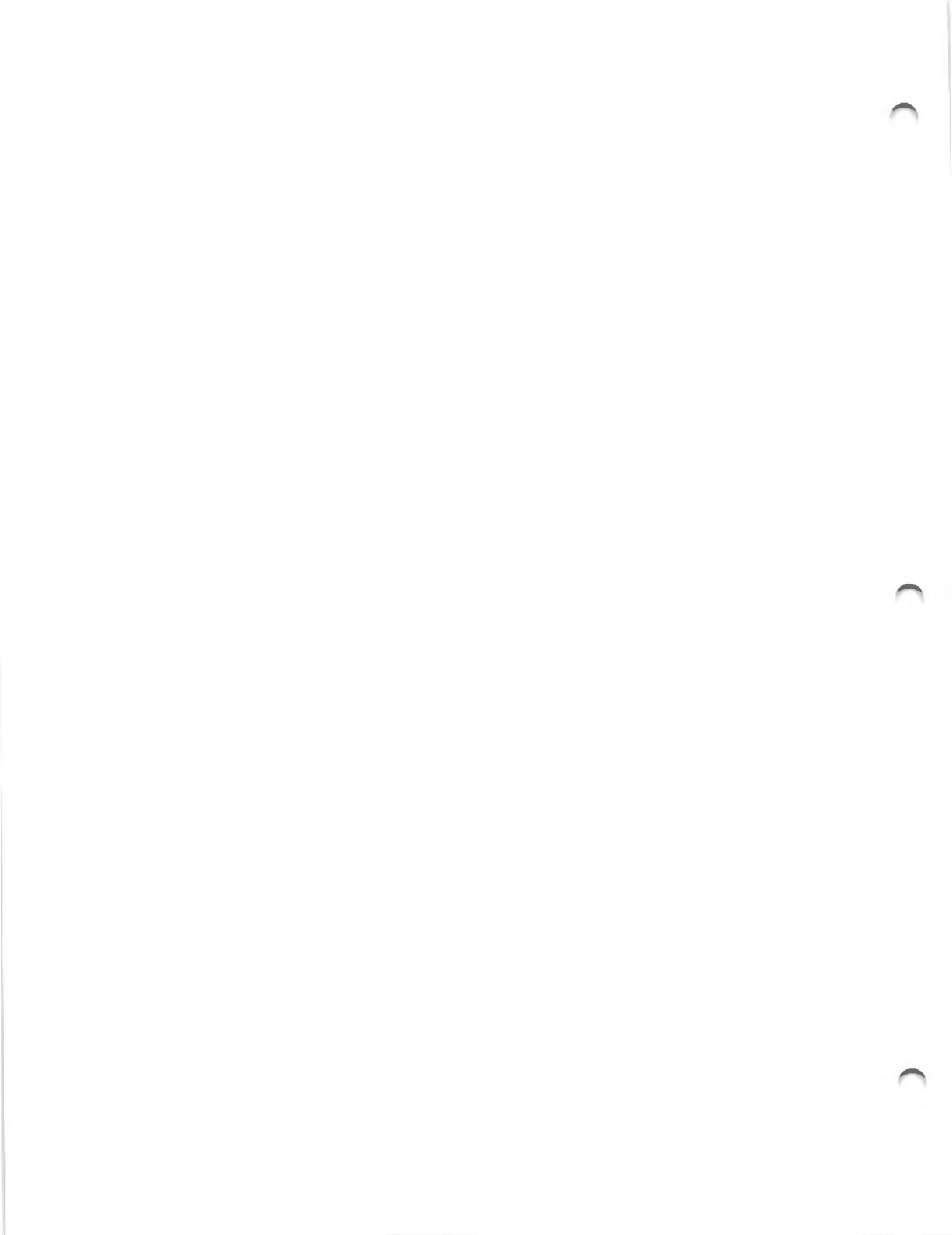

Part No.	Name	No. Required										
		732	733	734	735	736	737	738	739	743	747	
214712	Smoking case cigar lighter complete .....	-	-	2	2	-	-	-	-	-	-	-
187561	Smoking case cigar lighter complete .....	-	-	-	-	-	2	-	-	-	-	-
182377	Smoking case cigar lighter tip .....	2	-	2	2	2	2	-	-	1	2	-
204996	Smoking case complete .....	-	-	-	-	-	-	-	-	1	2	-

SUN VISOR

179077	Sun visor hinge .....	2	2	2	2	2	2	2	-	-	-	-
206886	Sun visor panel trimmed assembly right (10-1/4" wide) (Furnish sample of material) .....	1	1	1	1	1	1	1	1	-	-	-
206887	Sun visor panel trimmed assembly left (10-1/4" wide) (Furnish sample of material) .....	1	1	1	1	1	1	1	1	-	-	-
215791	Sun visor panel trimmed assembly right (9-1/2" wide) (Furnish sample of material) .....	-	-	-	-	-	-	1	-	-	-	-
215792	Sun visor panel trimmed assembly left (9-1/2" wide) (Furnish sample of material) .....	-	-	-	-	-	-	1	-	-	-	-

TOGGLE GRIP

206011	Toggle grip (Specify color of upholster- ing material) .....	2	2	2	2	2	2	-	-	-	-	-
206012	Toggle grip loop .....	2	2	2	2	2	2	-	-	-	-	-
206013	Toggle grip loop ferrule .....	2	2	2	2	2	2	-	-	-	-	-

TONNEAU LIGHT

180645	Tonneau light assembly .....	-	-	-	-	-	-	-	-	2	-	-
102590	Tonneau light bulb .....	-	-	-	-	-	-	-	-	2	-	-
180646	Tonneau light-glass and rim .....	-	-	-	-	-	-	-	-	2	-	-
180647	Tonneau light reflector .....	-	-	-	-	-	-	-	-	2	-	-
185031	Tonneau light switch .....	-	-	-	-	-	-	-	-	2	-	-
127502	Tonneau light switch plunger plate .....	-	-	-	-	-	-	-	-	2	-	-

TOP

212434	Top assembly .....	-	-	-	-	-	-	-	-	1	-	-
193092	Top center bow .....	-	-	-	-	-	-	-	-	1	-	-
193418	Top envelope assembly .....	-	-	-	-	-	-	-	-	1	-	-
193181	Top folding pillar bumper .....	-	-	-	-	-	-	-	-	2	-	-
193082	Top folding pillar hinge .....	-	-	-	-	-	-	-	-	2	-	-
8234	Screw 1/4-28 x 1-3/4" flat hd. ....	-	-	-	-	-	-	-	-	6	-	-
62065	Washer 1/4" special .....	-	-	-	-	-	-	-	-	6	-	-
5502	Lockwasher 1/4" std. ....	-	-	-	-	-	-	-	-	6	-	-
7004	Nut 1/4-28 .....	-	-	-	-	-	-	-	-	6	-	-
193148	Top folding pillar hinge bracket-right ...	-	-	-	-	-	-	-	-	1	-	-
193147	Top folding pillar hinge bracket-left ....	-	-	-	-	-	-	-	-	1	-	-
7613	Bolt 1/4-28 x 1-3/4" carriage .....	-	-	-	-	-	-	-	-	8	-	-
5502	Lockwasher 1/4" std. ....	-	-	-	-	-	-	-	-	8	-	-
7004	Nut 1/4-28 .....	-	-	-	-	-	-	-	-	8	-	-
193162	Top folding pillar hinge pin .....	-	-	-	-	-	-	-	-	2	-	-
5504	Lockwasher 5/16" std. ....	-	-	-	-	-	-	-	-	2	-	-
193429	Top folding pillar and side rail assembly.	-	-	-	-	-	-	-	-	1	-	-

Piece No.	Name	No. Required										
		732	733	734	735	736	737	738	739	743	747	
195794	Top hold down strap assembly-center .....	-	-	-	-	-	-	-	-	2	-	-
195795	Top hold down strap assembly .....	-	-	-	-	-	-	-	-	-	2	-
193437	Top to front pillar weatherstrip right ...	-	-	-	-	-	-	-	1	1	1	-
193438	Top to front pillar weatherstrip left ....	-	-	-	-	-	-	-	1	1	1	-
195700	Top main bow .....	-	-	-	-	-	-	-	-	-	1	-
212396	Top main bow hinge assembly-right .....	-	-	-	-	-	-	-	-	-	1	-
212397	Top main bow hinge assembly-left .....	-	-	-	-	-	-	-	-	-	1	-
212398	Top main bow upper hinge assembly-right ..	-	-	-	-	-	-	-	-	1	-	-
212399	Top main bow upper hinge assembly-left ...	-	-	-	-	-	-	-	-	1	-	-
212408	Top prop assembly .....	-	-	-	-	-	-	-	-	2	-	-
193629	Top prop-right assembly .....	-	-	-	-	-	-	-	1	-	-	-
212409	Top prop-right assembly .....	-	-	-	-	-	-	-	-	-	1	-
212410	Top prop-left assembly .....	-	-	-	-	-	-	-	-	-	1	-
193630	Top prop-left assembly .....	-	-	-	-	-	-	-	1	-	-	-
193150	Top prop bracket-upper right .....	-	-	-	-	-	-	-	1	-	-	-
193149	Top prop bracket-upper left .....	-	-	-	-	-	-	-	1	-	-	-
193224	Top prop pivot stud .....	-	-	-	-	-	-	-	4	-	-	-
193060	Top prop roller .....	-	-	-	-	-	-	-	2	-	-	-
193061	Top prop roller screw .....	-	-	-	-	-	-	-	2	-	-	-
5935	Lockwasher No. 10 Shakeproof .....	-	-	-	-	-	-	-	2	-	-	-
212157	Top rear bow .....	-	-	-	-	-	-	-	1	-	-	-
212380	Top rear bow .....	-	-	-	-	-	-	-	-	1	-	-
212381	Top rear bow .....	-	-	-	-	-	-	-	-	-	1	-
193417	Top rear bow and slat assembly .....	-	-	-	-	-	-	-	1	-	-	-
142849	Top rear bow slat iron spacer .....	-	-	-	-	-	-	-	2	-	-	-
184505	Top rear bow slat tee nut .....	-	-	-	-	-	-	-	2	-	-	-
195270	Top rear curtain window glass .....	-	-	-	-	-	-	-	1	-	-	-
195744	Top rear curtain window glass .....	-	-	-	-	-	-	-	-	1	1	-
193249	Top rear curtain window .....	-	-	-	-	-	-	-	1	-	-	-
195732	Top rear curtain window frame .....	-	-	-	-	-	-	-	-	1	1	-
193056	Top side rail center hinge assembly .....	-	-	-	-	-	-	-	2	-	-	-
212388	Top side rail center hinge assembly right.	-	-	-	-	-	-	-	-	1	-	-
212389	Top side rail center hinge assembly left .	-	-	-	-	-	-	-	-	1	-	-
193083	Top side rail center hinge joint clamp ...	-	-	-	-	-	-	-	2	-	-	-
193084	Top side rail center hinge joint clamp plate .....	-	-	-	-	-	-	-	2	-	-	-
5954	Screw No. 10-32 x 5/16" oval hd. ....	-	-	-	-	-	-	-	4	-	-	-
193138	Top side rail to folding pillar hinge right .....	-	-	-	-	-	-	-	1	-	-	-
193137	Top side rail to folding pillar hinge left	-	-	-	-	-	-	-	1	-	-	-
156406	Top side rail to folding pillar hinge pin screw 5/16-24 x 1-3/8" fill. hd. ....	-	-	-	-	-	-	-	2	-	-	-
212394	Top side rail to header hinge-right .....	-	-	-	-	-	-	-	-	-	1	-
212395	Top side rail to header hinge-left .....	-	-	-	-	-	-	-	-	-	1	-
193425	Top side rail to header hinge-right asb. .	-	-	-	-	-	-	-	1	-	-	-
212392	Top side rail to header hinge-right asb. .	-	-	-	-	-	-	-	-	1	-	-
193426	Top side rail to header hinge-left asb. ..	-	-	-	-	-	-	-	1	-	-	-
212393	Top side rail to header hinge-left asb. ..	-	-	-	-	-	-	-	-	1	-	-
193164	Top side rail to header hinge pin .....	-	-	-	-	-	-	-	2	-	-	-
195748	Top side rail locking device handle-right.	-	-	-	-	-	-	-	-	-	1	-
195749	Top side rail locking device handle-left .	-	-	-	-	-	-	-	-	-	1	-
212400	Top side roof rail rear hinge assembly- right .....	-	-	-	-	-	-	-	-	1	-	-
212401	Top side roof rail rear hinge assembly- left .....	-	-	-	-	-	-	-	-	1	-	-
193180	Top to windshield clamp assembly .....	-	-	-	-	-	-	-	2	2	-	-
195720	Top to windshield clamp assembly .....	-	-	-	-	-	-	-	-	-	2	-
193142	Top to windshield clamp bracket .....	-	-	-	-	-	-	-	2	-	-	-
195713	Top to windshield clamp bracket .....	-	-	-	-	-	-	-	-	-	2	-
195685	Top to windshield clamp bracket screw ....	-	-	-	-	-	-	-	4	-	-	-



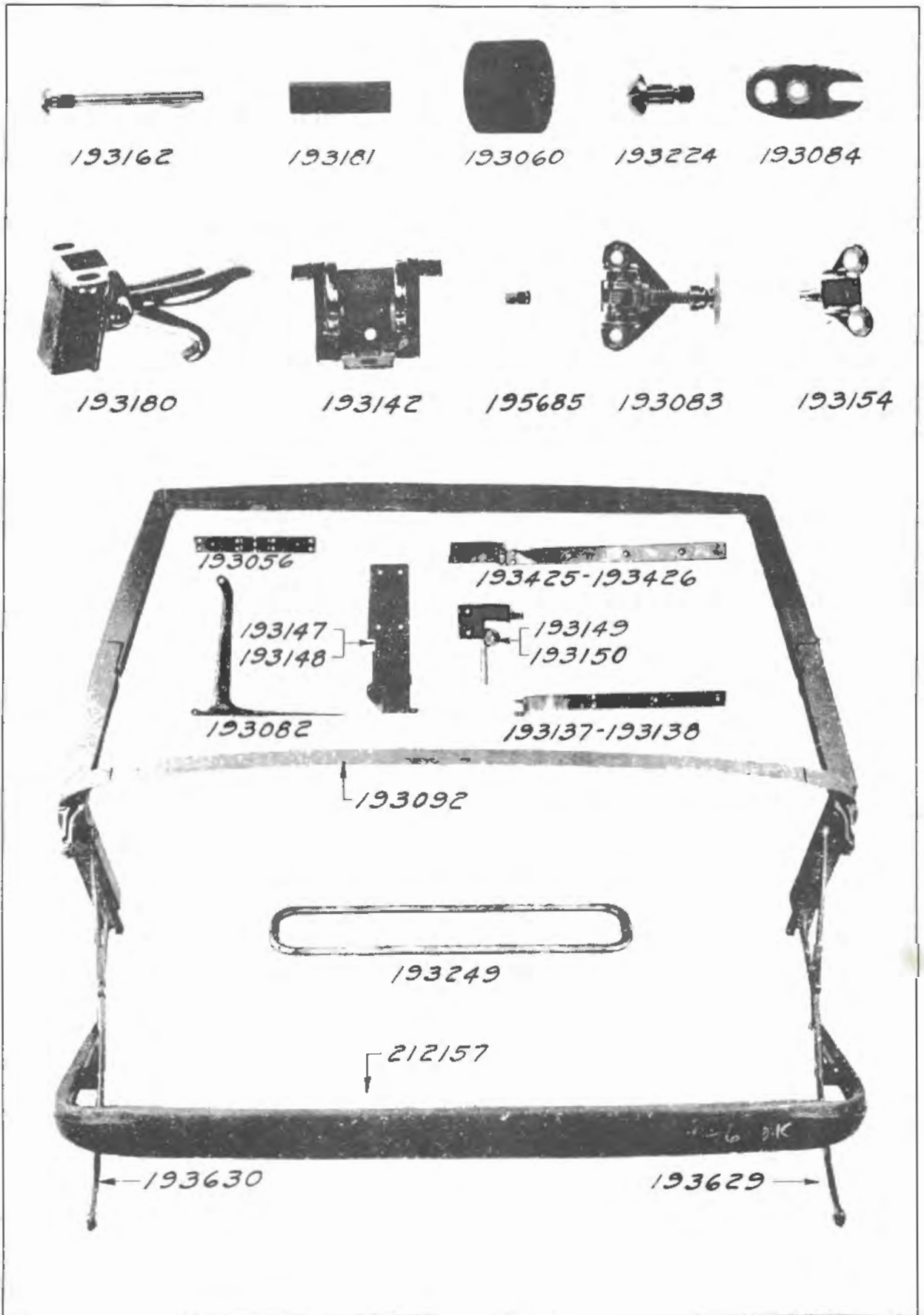

C

C

\_\_\_\_\_

C

Piece No.	Name	No. Required											
		732	733	734	735	736	737	738	739	743	747		
193154	Top to windshield clamp catch .....	-	-	-	-	-	-	-	-	-	-	2	-
212432	Top to windshield clamp catch .....	-	-	-	-	-	-	-	-	-	-	-	2
5954	Screw No. 10-32 x 5/16" oval hd. ....	-	-	-	-	-	-	-	-	-	-	4	4
193436	Top to windshield header weatherstrip ....	-	-	-	-	-	-	-	-	-	-	1	1

TRUNK

218449	Trunk assembly .....	-	-	-	-	-	-	-	-	-	-	-	-	1
212941	Trunk assembly .....	-	-	-	-	-	-	-	1	-	-	-	-	-
5253	Screw No. 10-32 x 3/4" rnd. hd. ....	-	-	-	-	-	-	-	6	-	-	-	-	-
5286	Screw No. 10-32 x 1" rnd. hd. ....	-	-	-	-	-	-	-	6	-	-	-	-	-
3867	Washer 3/16" special .....	-	-	-	-	-	-	-	6	-	-	-	-	-
5500	Lockwasher 3/16" .....	-	-	-	-	-	-	-	6	-	-	-	-	-
7003	Nut No. 10-32 .....	-	-	-	-	-	-	-	6	-	-	-	-	-
5684	Bolt 1/4-28 x 1-7/8" common carriage .	-	-	-	-	-	-	-	1	-	-	-	-	-
7610	Bolt 1/4-28 x 2-1/8" common carriage .	-	-	-	-	-	-	-	2	-	-	-	-	-
7620	Bolt 1/4-28 x 2-3/4" common carriage .	-	-	-	-	-	-	-	2	-	-	-	-	-
5817	Lockwasher 1/4" Shakeproof (Woodtype).	-	-	-	-	-	-	-	5	-	-	-	-	-
7004	Nut 1/4-28 .....	-	-	-	-	-	-	-	5	-	-	-	-	-
185270	Trunk assembly shim 3/8" thick .....	-	-	-	-	-	-	-	x	-	-	-	-	-
185274	Trunk assembly shim 1/2" thick .....	-	-	-	-	-	-	-	x	-	-	-	-	-
185273	Trunk assembly shim 3/16" thick .....	-	-	-	-	-	-	-	x	-	-	-	-	-
212799	Trunk to body liner .....	-	-	-	-	-	-	-	1	-	-	-	-	-
218448	Trunk to body liner .....	-	-	-	-	-	-	-	-	-	-	-	-	1
29664	Tacks 4 oz. trimmers.....	-	-	-	-	-	-	-	x	-	-	-	-	-
212280	Trunk key lock .....	-	-	-	-	-	-	-	1	-	-	-	-	1
212298	Trunk lid clamp .....	-	-	-	-	-	-	-	2	-	-	-	-	2
184249	Trunk lid clamp screw ferrule No. 8 .....	-	-	-	-	-	-	-	4	-	-	-	-	4
8018	Screw No. 8-32 x 7/16" oval hd. ....	-	-	-	-	-	-	-	4	-	-	-	-	4
5581	Trunk lid clamp lockwasher No. 8 .....	-	-	-	-	-	-	-	4	-	-	-	-	4
212297	Trunk lid clamp bracket .....	-	-	-	-	-	-	-	2	-	-	-	-	2
212299	Trunk lid clamp bracket washer .....	-	-	-	-	-	-	-	4	-	-	-	-	4
184249	Trunk lid clamp bracket screw ferrule No.8	-	-	-	-	-	-	-	4	-	-	-	-	4
5312	Screw No. 8-32 x 3/8" oval hd. ....	-	-	-	-	-	-	-	4	-	-	-	-	4
5581	Lockwasher No. 8 .....	-	-	-	-	-	-	-	4	-	-	-	-	4
212436	Trunk lid clamp bracket liner .....	-	-	-	-	-	-	-	2	-	-	-	-	-
212435	Trunk lid clamp liner .....	-	-	-	-	-	-	-	2	-	-	-	-	-
212974	Trunk lid hinge-right .....	-	-	-	-	-	-	-	1	-	-	-	-	-
212975	Trunk lid hinge-left .....	-	-	-	-	-	-	-	1	-	-	-	-	-
218445	Trunk lid hinge-right .....	-	-	-	-	-	-	-	-	-	-	-	-	1
218446	Trunk lid hinge-left .....	-	-	-	-	-	-	-	-	-	-	-	-	1
212299	Trunk lid hinge washer 1/4" .....	-	-	-	-	-	-	-	2	-	-	-	-	-
5447	Trunk lid hinge lockwasher 1/4" .....	-	-	-	-	-	-	-	4	-	-	-	-	-
7004	Nut 1/4-28 .....	-	-	-	-	-	-	-	4	-	-	-	-	-
6056	Lockwasher No. 10 .....	-	-	-	-	-	-	-	12	-	-	-	-	-
5253	Screw No. 10-32 x 3/4" rnd. hd. ....	-	-	-	-	-	-	-	12	-	-	-	-	-
7901	Screw No. 10-32 x 5/8" rnd. hd. ....	-	-	-	-	-	-	-	12	-	-	-	-	-
212304	Screw 1/4-28 x 9/16" special hd. ....	-	-	-	-	-	-	-	4	-	-	-	-	-
218308	Trunk lid hinge shim .....	-	-	-	-	-	-	-	x	-	-	-	-	-
212281	Trunk lid weatherstrip .....	-	-	-	-	-	-	-	1	-	-	-	-	-
218447	Trunk lid weatherstrip .....	-	-	-	-	-	-	-	-	-	-	-	-	1
212324	Trunk rear wheel carrier brace grommet (Use only with rear wheel carrier) .....	-	-	-	-	-	-	-	1	-	-	-	-	-

VENTILATOR

206014	Ventilator complete .....	1	1	1	1	1	1	-	-	-	-	-	-
206015	Ventilator cover assembly .....	1	1	1	1	1	1	-	-	-	-	-	-
187098	Ventilator cover assembly .....	-	-	-	-	-	-	1	1	1	1	1	1

Piece No.	Name	No. Required									
		732	733	734	735	736	737	738	739	743	747
5569	Ventilator cover attaching screw No. 10-32 x 5/8" fill. hd. ....	4	4	4	4	4	4	-	-	-	-
5500	Lockwasher No. 10 std. ....	4	4	4	4	4	4	-	-	-	-
7003	Nut No. 10-32 ....	4	4	4	4	4	4	-	-	-	-
5471	Screw 1/4-28 x 3/4" hex. hd. ....	1	1	1	1	1	1	-	-	-	-
5873	Screw 1/4-28 x 9/16" hex. hd. ....	2	2	2	2	2	2	-	-	-	-
5502	Lockwasher 1/4" std. ....	3	3	3	3	3	3	-	-	-	-
7004	Nut 1/4-28 ....	3	3	3	3	3	3	-	-	-	-
137537	Ventilator cover hinge screw ....	-	-	-	-	-	-	2	2	2	2
204354	Ventilator cover hinge screw ....	2	2	2	2	2	2	-	-	-	-
3868	Washer 1/4" "N" std. ....	-	-	-	-	-	-	2	2	2	2
5500	Lockwasher No. 10 std. ....	2	2	2	2	2	2	-	-	2	2
7003	Nut No. 10-32 ....	2	2	2	2	2	2	-	-	2	2
7104	Nut 1/4-28 castle ....	-	-	-	-	-	-	2	2	2	2
4280	Pin 1/16 x 1/2" cotter ....	-	-	-	-	-	-	2	2	2	2
185776	Ventilator cover operating lever ....	-	-	-	-	-	-	1	1	1	1
7800	Screw 1/4-28 x 1" hex. hd. ....	-	-	-	-	-	-	2	2	2	2
5502	Lockwasher 1/4" std. ....	-	-	-	-	-	-	2	2	2	2
7004	Nut 1/4-28 ....	-	-	-	-	-	-	2	2	2	2
3868	Washer 1/4" "N" std. ....	-	-	-	-	-	-	2	2	2	2
118555	Ventilator cover operating lever pin ....	-	-	-	-	-	-	1	1	1	1
118771	Ventilator operating pin roller ....	-	-	-	-	-	-	1	1	1	1
4280	Pin 1/16 x 1/2" cotter ....	-	-	-	-	-	-	1	1	1	1
206016	Ventilator cover operating lever and roller assembly ....	1	1	1	1	1	1	-	-	-	-
206086	Ventilator cover operating lever ratchet assembly ....	1	1	1	1	1	1	-	-	-	-
187192	Ventilator cover operating lever ratchet .	-	-	-	-	-	-	1	1	1	1
5792	Ventilator cover operating lever ratchet yoke end pin 5/16" ....	1	1	1	1	1	1	1	1	1	1
4290	Pin 3/32 x 5/8" cotter ....	1	1	1	1	1	1	1	1	1	1
199374	Ventilator cover spring ....	1	1	1	1	1	1	-	-	-	-
138261	Ventilator cover spring ....	-	-	-	-	-	-	1	1	1	1
206018	Ventilator drain gutter assembly ....	1	1	1	1	1	1	-	-	-	-
5253	Ventilator drain gutter to dash screw No. 10-32 x 3/4" rnd. hd. mach. ..	1	1	1	1	1	1	-	-	-	-
5500	Lockwasher No. 10 std. ....	1	1	1	1	1	1	-	-	-	-
196493	Ventilator drain tube hose ....	2	2	2	2	2	2	-	-	-	-
5286	Ventilator drain tube hose clamp screw No. 10-32 x 1" rnd. hd. ....	2	2	2	2	2	2	-	-	-	-
5500	Lockwasher No. 10 std. ....	2	2	2	2	2	2	-	-	-	-
7003	Nut No. 10-32 ....	2	2	2	2	2	2	-	-	-	-
145383	Ventilator hinge adjusting plate asb.-left	-	-	-	-	-	-	1	1	1	1
145384	Ventilator hinge adjusting plate asb.-right	-	-	-	-	-	-	1	1	1	1
187137	Ventilator screen assembly ....	-	-	-	-	-	-	1	1	1	1
8011	Screw No. 8-32 x 7/16" oval hd. ....	-	-	-	-	-	-	6	6	6	6
3774	Lockwasher No. 8 std. ....	-	-	-	-	-	-	6	6	6	6
7002	Nut No. 8-32 ....	-	-	-	-	-	-	6	6	6	6
206036	Ventilator side door gutter and operating lever bracket assembly right	1	1	1	1	1	1	-	-	-	-
185800	Ventilator side door gutter and operating lever bracket assembly right	-	-	-	-	-	-	1	1	1	1
206037	Ventilator side door gutter and operating lever bracket assembly left	1	1	1	1	1	1	-	-	-	-
185799	Ventilator side door gutter and operating lever bracket assembly left	-	-	-	-	-	-	1	1	1	1
206038	Ventilator side door and hinge assembly right	1	1	1	1	1	1	-	-	-	-
185798	Ventilator side door and hinge assembly right	-	-	-	-	-	-	1	1	1	1

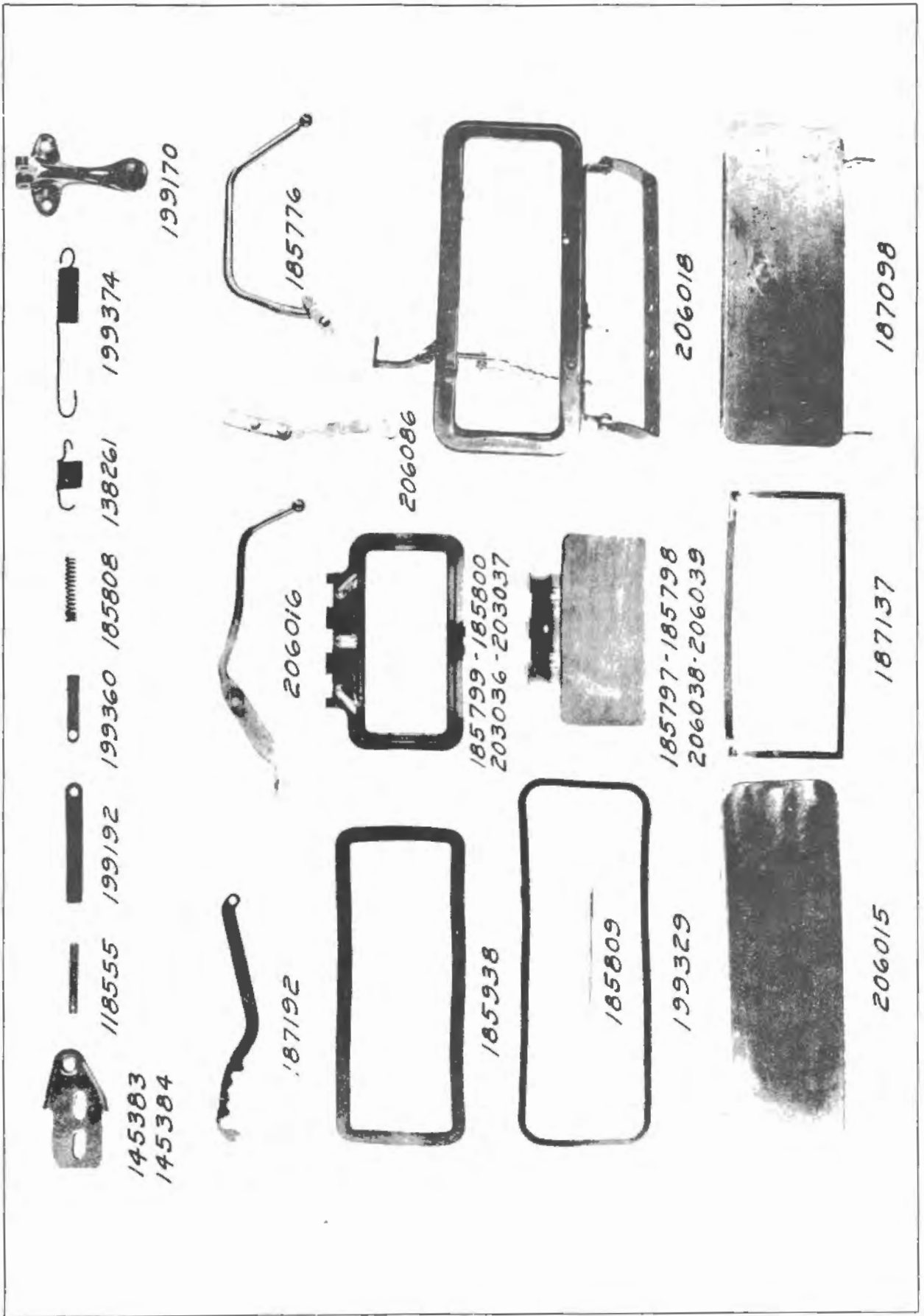



Piece No.	Name	No. Required									
		732	733	734	735	736	737	738	739	743	747
206039	Ventilator side door and hinge assembly left .....	1	1	1	1	1	1	-	-	-	-
185797	Ventilator side door and hinge assembly left .....	-	-	-	-	-	-	1	1	1	1
185893	Ventilator side door hinge bumper .....	2	2	2	2	2	2	2	2	2	2
185809	Ventilator side door hinge pin .....	2	2	2	2	2	2	2	2	2	2
4690	Pin spring cotter 1/16 x 3/8" .....	2	2	2	2	2	2	2	2	2	2
199170	Ventilator side door operating lever handle .....	2	2	2	2	2	2	2	2	2	2
5954	Screw No. 10-32 x 5/16" oval hd. ....	4	4	4	4	4	4	4	4	4	4
199360	Ventilator side door operating lever plunger .....	2	2	2	2	2	2	2	2	2	2
5346	Screw No. 10-32 x 7/8" rnd. hd. ....	2	2	2	2	2	2	2	2	2	2
5500	Lockwasher No. 10 .....	2	2	2	2	2	2	2	2	2	2
7003	Nut No. 10-32 .....	2	2	2	2	2	2	2	2	2	2
199192	Ventilator side door operating lever sleeve .....	2	2	2	2	2	2	2	2	2	2
5667	Screw No. 10-32 x 5/8" rnd. hd. ....	2	2	2	2	2	2	2	2	2	2
5500	Lockwasher No. 10 .....	2	2	2	2	2	2	2	2	2	2
7003	Nut No. 10-32 .....	2	2	2	2	2	2	2	2	2	2
185808	Ventilator side door operating spring ....	2	2	2	2	2	2	2	2	2	2
185814	Ventilator side weatherstrip .....	2	2	2	2	2	2	2	2	2	2
185938	Ventilator weatherstrip .....	-	-	-	-	-	-	-	1	1	1
199329	Ventilator weatherstrip .....	1	1	1	1	1	1	1	-	-	-

WINDOW

212706	Window curtain rear assembly (with 13/16" diameter roller) .....	-	1	1	1	1	1	-	-	-	-
212096	Window curtain rear assembly (with 13/16" diameter roller) .....	1	-	-	-	-	-	-	-	-	-
204962	Window curtain rear assembly (with 13/16" diameter roller) .....	-	-	-	-	-	-	1	-	-	-
218460	Window curtain rear assembly (with 5/8" diameter roller) .....	-	1	1	1	1	1	-	-	-	-
218469	Window curtain rear assembly (with 5/8" diameter roller) .....	1	-	-	-	-	-	-	-	-	-
218468	Window curtain rear assembly (with 5/8" diameter roller) .....	-	-	-	-	-	-	1	-	-	-
218461	Window curtain side assembly (with 5/8" diameter roller) .....	-	2	-	-	-	-	-	-	-	-
218462	Window curtain side assembly (with 5/8" diameter roller) .....	-	-	2	2	-	-	-	-	-	-
218464	Window curtain side assembly (with 5/8" diameter roller) .....	-	-	-	-	-	2	-	-	-	-
214760	Window curtain side assembly (with 13/16" diameter roller) .....	-	2	-	-	-	-	-	-	-	-
214762	Window curtain side assembly (with 13/16" diameter roller) .....	-	-	2	2	-	-	-	-	-	-
214764	Window curtain side assembly (with 13/16" diameter roller) .....	-	-	-	-	-	2	-	-	-	-
212659	Window curtain roller rear (13/16" diameter) .....	-	1	1	1	1	1	-	-	-	-
204968	Window curtain roller rear assembly (13/16" diameter) .....	-	-	-	-	-	-	1	-	-	-
218404	Window curtain roller rear (5/8" diameter)	-	1	1	1	1	1	-	-	-	-
218475	Window curtain roller rear assembly (5/8" diameter) .....	-	-	-	-	-	-	1	-	-	-
218474	Window curtain roller rear (5/8" diameter)	1	-	-	-	-	-	-	-	-	-

Piece No	Name	No. Required												
		732	733	734	735	736	737	738	739	743	747			
218405	Window curtain roller side (5/8" diameter)	-	2	-	-	-	-	-	-	-	-	-	-	-
218406	Window curtain roller side (5/8" diameter)	-	-	2	2	-	-	-	-	-	-	-	-	-
218407	Window curtain roller side (5/8" diameter)	-	-	-	-	-	2	-	-	-	-	-	-	-
214379	Window curtain roller side (13/16" diameter)	-	2	-	-	-	-	-	-	-	-	-	-	-
214569	Window curtain roller side (13/16" diameter)	-	-	2	2	-	-	-	-	-	-	-	-	-
214481	Window curtain roller side (13/16" diameter)	-	-	-	-	-	2	-	-	-	-	-	-	-
184441	Window curtain roller rear (13/16" diameter)	1	-	-	-	-	-	-	-	-	-	-	-	-
206074	Window curtain roller bracket female	-	-	-	-	-	-	1	-	-	-	-	-	-
206075	Window curtain roller bracket male (Use with 13/16" diameter roller)	-	-	-	-	-	-	1	-	-	-	-	-	-
212661	Window curtain roller bracket female (rear (Use with 13/16" diameter roller)	-	1	1	1	1	1	-	-	-	-	-	-	-
212662	Window curtain roller bracket male asb. rear (Use with 13/16" diameter roller)	-	1	1	1	1	1	-	-	-	-	-	-	-
214380	Window curtain roller bracket male asb. side (Use with 13/16" diameter roller)	-	2	2	2	-	2	-	-	-	-	-	-	-
218476	Window curtain roller bracket male (Use with 5/8" diameter roller)	-	-	-	-	-	-	1	-	-	-	-	-	-
218503	Window curtain roller bracket female rear (Use with 5/8" diameter roller)	-	1	1	1	1	1	-	-	-	-	-	-	-
218412	Window curtain roller bracket male asb. rear (Use with 5/8" diameter roller)	-	1	1	1	1	1	-	-	-	-	-	-	-
218411	Window curtain roller bracket male asb. side (Use with 5/8" diameter roller)	-	2	2	2	-	2	-	-	-	-	-	-	-
211207	Window curtain stick rear	1	-	-	-	-	-	1	-	-	-	-	-	-
173514	Window curtain tassel	1	-	-	-	-	-	-	-	-	-	-	-	-
218450	Window door frame and glass assembly right	-	-	-	-	-	-	-	-	-	-	-	-	1
218451	Window door frame and glass assembly left.	-	-	-	-	-	-	-	-	-	-	-	-	1
218452	Window (door front) frame and glass asb. right	-	-	-	-	-	-	-	-	-	-	1	-	-
218453	Window (door front) frame and glass asb. left	-	-	-	-	-	-	-	-	-	-	1	-	-
218454	Window (door rear) frame and glass asb. right	-	-	-	-	-	-	-	-	-	-	1	-	-
218455	Window (door rear) frame and glass asb. left	-	-	-	-	-	-	-	-	-	-	1	-	-
214842	Window (door) glass	-	-	-	-	-	-	2	2	-	-	-	-	-
218456	Window (door) glass	-	-	-	-	-	-	-	-	-	-	-	-	2
218786	Window (door) glass and lifter assembly stop bracket	-	-	-	-	-	-	4	4	-	-	-	-	-
5828	Screw No. 10-32 x 13/16" flat hd.	-	-	-	-	-	-	8	8	-	-	-	-	-
6056	Lockwasher	-	-	-	-	-	-	8	8	-	-	-	-	-
7003	Nut No. 10-32	-	-	-	-	-	-	8	8	-	-	-	-	-
183172	Window (door) regulator right	-	-	-	-	-	-	1	1	-	-	-	-	-
212416	Window (door) regulator right front	-	-	-	-	-	-	-	-	-	1	-	-	-
183173	Window (door) regulator left	-	-	-	-	-	-	1	1	-	-	-	-	-
212417	Window (door) regulator left front	-	-	-	-	-	-	-	-	-	1	-	-	-
183838	Window (door) regulator-handle	-	-	-	-	-	-	2	2	-	-	-	-	-
214446	Window (door) regulator-handle	-	-	-	-	-	-	-	-	-	2	-	-	2
183839	Window (door) regulator-handle escutcheon plate	-	-	-	-	-	-	2	2	2	2	2	2	2
133264	Window (door) regulator-handle escutcheon plate spring	-	-	-	-	-	-	2	2	2	2	2	2	2
133339	Window (door) regulator-handle insert	-	-	-	-	-	-	2	2	2	2	2	2	2
132972	Window (door) regulator-handle pin	-	-	-	-	-	-	2	2	2	2	2	2	2
214743	Window (door) runway front-right	-	-	-	-	-	-	1	1	-	-	-	-	-
214742	Window (door) runway front-left	-	-	-	-	-	-	1	1	-	-	-	-	-





183839  
214779



218310



212490



211409



212274



131316  
187981



214311



211668



133264



212662  
214380



212661



206075



206074



212171 214622



212659-214379-214481-214569



173514



162217



184441 204968

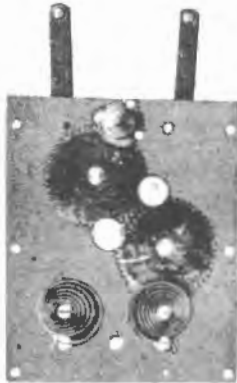

212102

183850-183851-184028-184029  
184052-184053-187878-187879  
212551-212552-212553  
212554-214871-214872

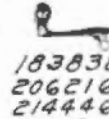

183838  
206216  
214446

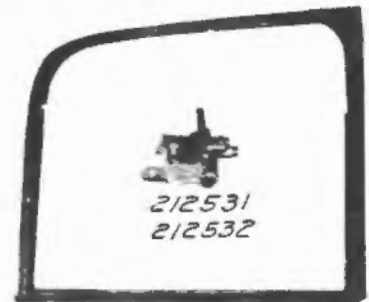

212595-212596



212531  
212532

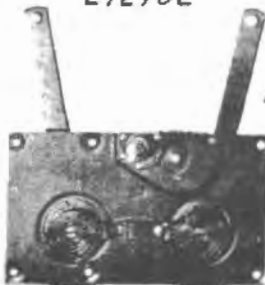

214621

187833-187834-199508  
204978-204979-214869  
214870-214873-214874



204518

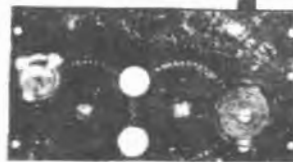

212534-212535

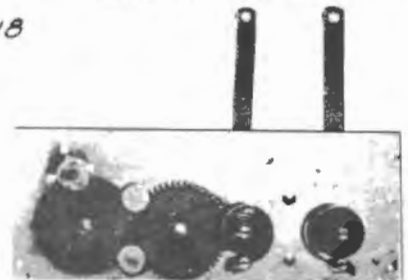

183172-183173

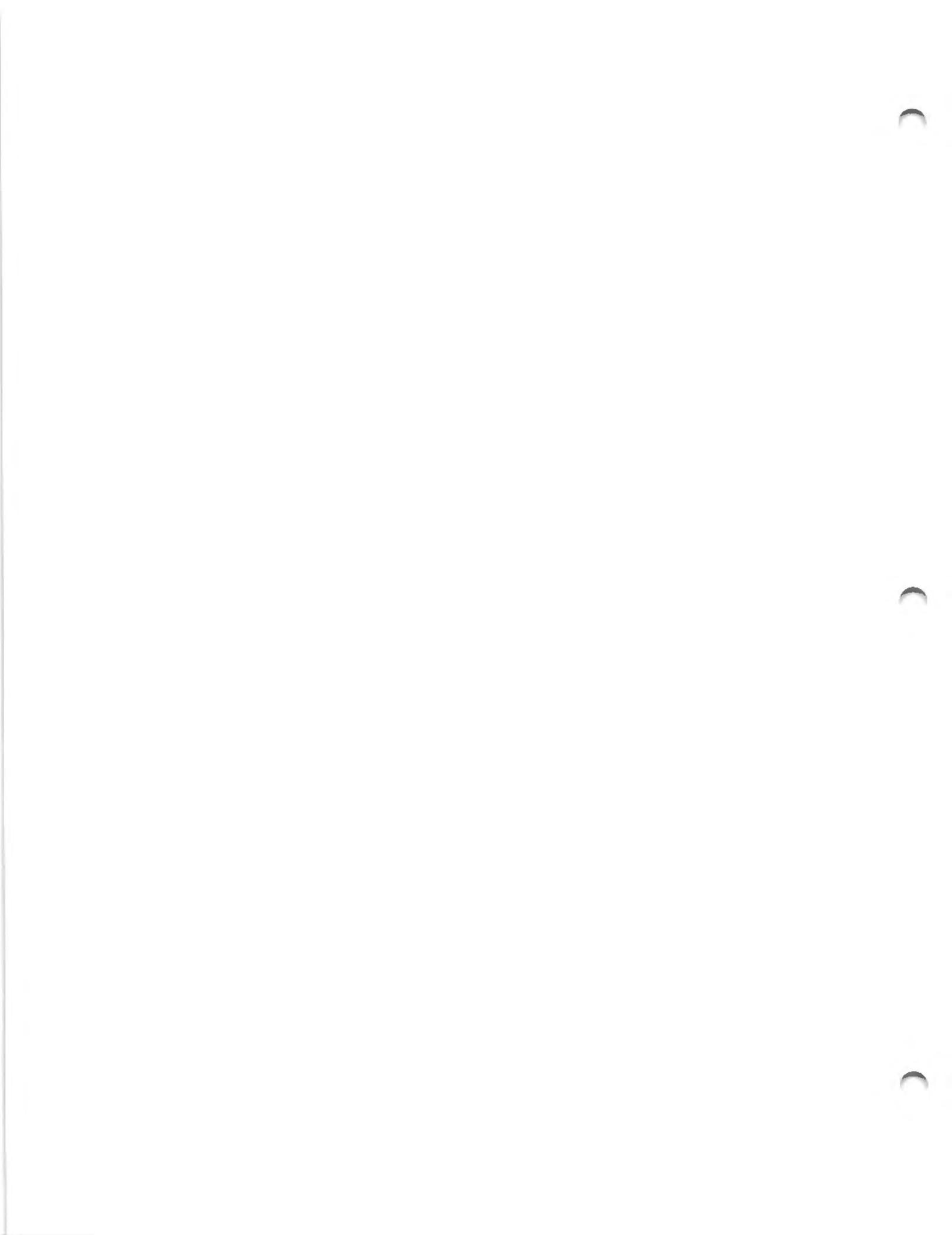

Piece No.	Name	No. Required									
		732	733	734	735	736	737	738	739	743	747
214744	Window (door) runway rear-right .....	-	-	-	-	-	-	1	1	-	-
214745	Window (door) runway rear-left .....	-	-	-	-	-	-	1	1	-	-
214330	Window (front door front) right assembly ..	1	1	1	1	1	1	-	-	-	-
214331	Window (front door front) left assembly ..	1	1	1	1	1	1	-	-	-	-
218457	Window (front door) glass .....	-	-	-	-	-	-	-	-	2	-
212526	Window (front door front) glass .....	2	2	2	2	2	2	-	-	-	-
212539	Window (front door front) glass and retainer assembly .....	2	2	2	2	2	2	-	-	-	-
212490	Window (front door front) pivot spring ...	2	2	2	2	2	2	-	-	-	-
211409	Window (front door front) pivot spring cap	2	2	2	2	2	2	-	-	-	-
212532	Window (front door front) regulator right assembly .....	1	1	1	1	1	1	-	-	-	-
212531	Window (front door front) regulator left assembly .....	1	1	1	1	1	1	-	-	-	-
214376	Stud 1/4 special .....	4	4	4	4	4	4	-	-	-	-
5447	Lockwasher 1/4 (Shakeproof) .....	4	4	4	4	4	4	-	-	-	-
7004	Nut 1/4-28 .....	4	4	4	4	4	4	-	-	-	-
214311	Window (front door front) regulator handle escutcheon plate .....	2	2	2	2	2	2	-	-	-	-
218310	Window (front door front) regulator handle escutcheon plate anti-rattler .....	2	2	2	2	2	2	-	-	-	-
214310	Window (front door front) regulator handle Screw No. 8 - 5/8 x 32 headless .....	2	2	2	2	2	2	-	-	-	-
180671	Window (front door front) regulator handle insert .....	2	2	2	2	2	2	-	-	-	-
212596	Window (front door front) weatherstrip right assembly .....	1	1	1	1	1	1	-	-	-	-
212595	Window (front door front) weatherstrip left assembly .....	1	1	1	1	1	1	-	-	-	-
143554	Window (front door rear) glass cushion ...	x	x	x	x	x	x	-	-	-	-
212541	Window (front door rear) glass .....	-	2	-	-	2	2	-	-	-	-
212540	Window (front door rear) glass .....	2	-	2	2	-	-	-	-	-	-
51331	Window (front door rear) glass cushion packing .....	x	x	x	x	x	x	-	-	-	-
212558	Window (front door rear) lifter bumper ...	-	2	-	-	2	2	-	-	-	-
212557	Window (front door rear) lifter bumper ...	2	-	2	2	-	-	-	-	-	-
212552	Window (front door rear) lifter right asb.	-	1	-	-	1	1	-	-	-	-
212551	Window (front door rear) lifter left asb..	-	1	-	-	1	1	-	-	-	-
212554	Window (front door rear) lifter right ....	1	-	1	1	-	-	-	-	-	-
212553	Window (front door rear) lifter left asb..	1	-	1	1	-	-	-	-	-	-
212534	Window (front door rear) regulator right .	1	1	1	1	1	1	-	-	-	-
212535	Window (front door rear) regulator left ..	1	1	1	1	1	1	-	-	-	-
183838	Window (front door rear) regulator handle.	2	2	2	2	2	2	-	-	-	-
183839	Window (front door rear) regulator handle escutcheon plate .....	2	2	2	2	2	2	-	-	-	-
133264	Window (front door rear) regulator handle escutcheon plate spring .....	2	2	2	2	2	2	-	-	-	-
133339	Window (front door rear) regulator handle insert .....	2	2	2	2	2	2	-	-	-	-
132972	Window (front door rear) regulator handle pin .....	2	2	2	2	2	2	-	-	-	-
212544	Window (front door rear) runway front ....	2	2	2	2	2	2	-	-	-	-
5711	Screw No. 4-40 x 7/32 flat hd. ....	4	4	4	4	4	4	-	-	-	-
175763	Screw No. 4 x 3/8 Parker-Kalon flat hd. ....	4	4	4	4	4	4	-	-	-	-
214716	Window (front door rear) runway rear .....	-	2	-	-	2	2	-	-	-	-
214715	Window (front door rear) runway rear .....	2	-	2	2	-	-	-	-	-	-
199571	Window (partition) anti-rattler rear .....	-	-	-	1	-	-	-	-	-	-
162217	Window (partition) glass bumper .....	-	-	-	2	-	-	-	-	-	-
131316	Window (partition) glass bumper lower ....	2	-	-	-	-	-	-	-	-	-

Piece No.	Name	No. Required												
		732	733	734	735	736	737	738	739	743	747			
212274	Window (partition) glass bumper upper ....	2	-	-	-	-	-	-	-	-	-	-	-	-
212170	Window (partition) glass .....	1	-	-	-	-	-	-	-	-	-	-	-	-
214686	Window (partition) glass .....	-	-	-	1	-	-	-	-	-	-	-	-	-
143554	Window (partition) glass cushion .....	x	-	-	x	-	-	-	-	-	-	-	-	-
51331	Window (partition) glass cushion packing .	x	-	-	x	-	-	-	-	-	-	-	-	-
214622	Window (partition) lifter assembly .....	-	-	-	1	-	-	-	-	-	-	-	-	-
212171	Window (partition) lifter assembly .....	1	-	-	-	-	-	-	-	-	-	-	-	-
214446	Window (partition) regulator handle .....	-	-	-	1	-	-	-	-	-	-	-	-	-
206216	Window (partition) regulator handle .....	1	-	-	-	-	-	-	-	-	-	-	-	-
183839	Window (partition) regulator handle escutcheon plate .....	-	-	-	1	-	-	-	-	-	-	-	-	-
214779	Window (partition) regulator handle escutcheon plate .....	1	-	-	-	-	-	-	-	-	-	-	-	-
133264	Window (partition) regulator handle escutcheon plate spring .....	-	-	-	1	-	-	-	-	-	-	-	-	-
204518	Window (partition) regulator handle escutcheon plate spring plate assembly .	-	-	-	1	-	-	-	-	-	-	-	-	-
133339	Window (partition) regulator handle insert	1	-	-	1	-	-	-	-	-	-	-	-	-
147910	Window (partition) regulator handle screw No. 8-32 x 5/8 headless .....	1	-	-	-	-	-	-	-	-	-	-	-	-
132972	Window (partition) regulator handle pin ...	-	-	-	1	-	-	-	-	-	-	-	-	-
214621	Window (partition) regulator .....	-	-	-	1	-	-	-	-	-	-	-	-	-
212102	Window (partition) regulator .....	1	-	-	-	-	-	-	-	-	-	-	-	-
8203	Screw No. 10-32 x 1-3/16 flat hd. ....	2	-	-	-	-	-	-	-	-	-	-	-	-
4819	Woodscrew No. 10 x 3/4 flat hd. brt. .	8	-	-	6	-	-	-	-	-	-	-	-	-
214688	Window (partition) runway .....	-	-	-	1	-	-	-	-	-	-	-	-	-
212103	Window (partition) runway .....	2	-	-	-	-	-	-	-	-	-	-	-	-
199254	Window (partition) weatherstrip .....	-	-	-	1	-	-	-	-	-	-	-	-	-
178949	Window (rear door) anti-rattler .....	2	2	2	2	2	-	-	-	-	-	-	-	-
214565	Window (rear door) glass .....	-	2	-	-	2	-	-	-	-	-	-	-	-
212671	Window (rear door) glass .....	2	-	2	2	-	-	-	-	-	-	-	-	-
218458	Window (rear door) glass .....	-	-	-	-	-	-	-	-	-	-	2	-	-
143554	Window (rear door) glass cushion .....	x	x	x	x	x	-	-	-	-	-	-	-	-
214655	Window (rear) glass cushion .....	-	1	1	1	1	1	-	-	-	-	-	-	-
183429	Window (rear) glass cushion .....	1	-	-	-	-	-	-	-	-	-	-	-	-
143554	Window (rear) glass cushion .....	-	-	-	-	-	-	x	-	-	-	-	-	-
199500	Window (rear) glass .....	-	-	-	-	-	-	1	-	-	-	-	-	-
183432	Window (rear) glass .....	1	-	-	-	-	-	-	-	-	-	-	-	-
185347	Window (rear) glass .....	-	1	1	1	1	1	-	-	-	-	-	-	-
51331	Window (rear door) glass cushion packing .	x	x	x	x	x	-	-	-	-	-	-	-	-
51331	Window (rear) glass packing .....	-	-	-	-	-	-	x	-	-	-	-	-	-
199504	Window (rear) lifter assembly .....	-	-	-	-	-	-	1	-	-	-	-	-	-
176787	Window (rear) lifter bumper .....	-	-	-	-	-	-	1	-	-	-	-	-	-
178926	Window (rear door) lifter bumper .....	2	-	2	2	-	-	-	-	-	-	-	-	-
177000	Window (rear door) lifter bumper .....	-	2	-	-	2	-	-	-	-	-	-	-	-
183850	Window (rear door) lifter right assembly .	-	1	-	-	1	-	-	-	-	-	-	-	-
184052	Window (rear door) lifter right assembly .	1	-	1	1	-	-	-	-	-	-	-	-	-
183851	Window (rear door) lifter left assembly ..	-	1	-	-	1	-	-	-	-	-	-	-	-
184053	Window (rear door) lifter left assembly ..	1	-	1	1	-	-	-	-	-	-	-	-	-
139508	Window (rear) regulator .....	-	-	-	-	-	-	1	-	-	-	-	-	-
204978	Window (rear door) regulator right .....	1	1	1	1	1	-	-	-	-	-	-	-	-
195790	Window (rear door) regulator right .....	-	-	-	-	-	-	-	-	-	1	-	-	-
204979	Window (rear door) regulator left .....	1	1	1	1	1	-	-	-	-	-	-	-	-
195791	Window (rear door) regulator left .....	-	-	-	-	-	-	-	-	-	1	-	-	-
211668	Window (rear) regulator handle .....	-	-	-	-	-	-	1	-	-	-	-	-	-
214446	Window (rear door) regulator handle .....	2	2	2	2	2	-	-	-	-	2	-	-	-
183839	Window (rear) regulator handle escutcheon plate .....	-	-	-	-	-	-	1	-	-	-	-	-	-
183839	Window (rear door) regulator handle escutcheon plate .....	2	2	2	2	2	-	-	-	-	2	-	-	-

Piece No.	Name	No. Required									
		732	733	744	735	736	737	738	739	743	747
133264	Window (rear door) regulator handle escutcheon plate spring .....	2	2	2	2	2	-	-	-	2	-
133264	Window (rear) regulator handle escutcheon plate spring .....	-	-	-	-	-	-	1	-	-	-
133339	Window (rear door) regulator handle insert	2	2	2	2	2	-	-	-	2	-
180671	Window (rear) regulator handle insert ....	-	-	-	-	-	-	1	-	-	-
132972	Window (rear door) regulator handle pin ..	2	2	2	2	2	-	-	-	2	-
132972	Window (rear) regulator handle pin .....	-	-	-	-	-	-	1	-	-	-
196119	Window (rear) runway .....	-	-	-	-	-	-	2	-	-	-
214461	Window (rear door) runway .....	2	-	2	2	-	-	-	-	-	-
214498	Window (rear door) runway .....	-	2	-	-	2	-	-	-	-	-
136008	Window runway shim 1/32 x 3/8 x 40 .....	x	x	x	x	x	x	x	-	-	-
132429	Window runway shim 1/16 x 3/8 x 40 .....	x	x	x	x	x	x	x	-	-	-
5798	Window runway nail No. 15 x 5/8 flat hd. .	x	x	x	x	x	x	x	-	-	-
143554	Window (side) glass cushion .....	-	x	x	x	-	x	-	-	-	-
212524	Window (side) glass .....	-	2	-	-	-	-	-	-	-	-
214748	Window (side) glass .....	-	-	-	-	-	2	-	-	-	-
212483	Window (side) glass .....	-	-	2	2	-	-	-	-	-	-
51331	Window (side) glass cushion packing .....	-	x	x	x	-	x	-	-	-	-
177003	Window (side) lifter bumper .....	-	-	-	-	-	2	-	-	-	-
177001	Window (side) lifter bumper .....	-	-	2	2	-	-	-	-	-	-
177002	Window (side) lifter bumper .....	-	2	-	-	-	-	-	-	-	-
187879	Window (side) lifter right assembly .....	-	-	-	-	-	1	-	-	-	-
214871	Window (side) lifter right assembly .....	-	1	-	-	-	-	-	-	-	-
214872	Window (side) lifter left assembly .....	-	1	-	-	-	-	-	-	-	-
187978	Window (side) lifter left assembly .....	-	-	-	-	-	1	-	-	-	-
184028	Window (side) lifter right assembly .....	-	-	1	1	-	-	-	-	-	-
184029	Window (side) lifter left assembly .....	-	-	1	1	-	-	-	-	-	-
187833	Window (side) regulator left .....	-	-	-	-	-	1	-	-	-	-
187834	Window (side) regulator right .....	-	-	-	-	-	1	-	-	-	-
214869	Window (side) regulator right .....	-	1	-	-	-	-	-	-	-	-
214873	Window (side) regulator right .....	-	-	1	1	-	-	-	-	-	-
214870	Window (side) regulator left .....	-	1	-	-	-	-	-	-	-	-
214874	Window (side) regulator left .....	-	-	1	1	-	-	-	-	-	-
206216	Window (side) regulator handle .....	-	2	2	2	-	-	-	-	-	-
214446	Window (side) regulator handle .....	-	-	-	-	-	2	-	-	-	-
214311	Window (side) regulator handle escutcheon plate .....	-	2	2	2	-	-	-	-	-	-
183839	Window (side) regulator handle escutcheon plate .....	-	-	-	-	-	2	-	-	-	-
218310	Window (side) regulator handle escutcheon plate anti-rattler .....	-	2	2	2	-	2	-	-	-	-
133264	Window (side) regulator handle escutcheon plate spring .....	-	-	-	-	-	2	-	-	-	-
133339	Window (side) regulator handle insert ....	-	-	-	-	-	2	-	-	-	-
132972	Window (side) regulator handle pin .....	-	-	-	-	-	2	-	-	-	-
147910	Window (side) regulator handle screw No. 8-32 x 5/8 headless .....	-	2	2	2	-	-	-	-	-	-
212480	Window (side) runway .....	-	-	2	2	-	-	-	-	-	-
214750	Window (side) runway .....	-	-	-	-	-	2	-	-	-	-
131316	Window stop block rubber bumper .....	8	10	10	12	8	8	-	-	-	-
187981	Window stop block rubber bumper .....	-	-	-	-	-	-	4	4	-	-

WINDSHIELD

204995	Windshield assembly .....	1	1	1	1	1	1	-	-	-	-
212854	Windshield assembly .....	-	-	-	-	-	-	1	1	1	1
5989	Windshield to body screw No. 8-32 x 1/2" oval hd. ....	-	-	-	-	-	-	4	4	4	4

Piece No.	Name	No. Required									
		732	733	734	735	736	737	738	739	743	747
6238	Windshield to body screw No. 8-32 x 7/16" flat hd. mach. ....	22	22	22	22	22	22	-	-	-	-
5586	Windshield to body screw No. 8-32 x 5/16" flat hd. mach. ....	-	-	-	-	-	-	24	24	24	24
218655	Windshield to body screw No. 8-32 x 5/16" binding head .....	-	-	-	-	-	-	24	24	24	24
206752	Windshield clamp-right .....	1	1	1	1	1	1	-	-	-	-
206753	Windshield clamp-left .....	1	1	1	1	1	1	-	-	-	-
206754	Windshield screw .....	4	4	4	4	4	4	-	-	-	-
193107	Windshield clamp ferrule-right .....	-	-	-	-	-	-	1	1	1	1
193106	Windshield clamp ferrule-left .....	-	-	-	-	-	-	1	1	1	1
193379	Windshield cleaner dash connection .....	-	-	-	-	-	-	1	1	1	1
173133	Screw No. 10 x 1/2" flat head (Parker-Kalon) .....	-	-	-	-	-	-	2	2	2	2
211295	Windshield cleaner dash connection vacuum supply tube assembly .....	-	-	-	-	-	-	1	1	1	1
157477	Windshield cleaner dash connection vacuum supply tube union nut .....	-	-	-	-	-	-	2	2	2	2
177851	Windshield cleaner dash connection vacuum supply tube (flared tube connection adapter) .....	-	-	-	-	-	-	2	2	2	2
140009	Windshield cleaner hose .....	-	-	-	-	-	-	4	4	4	4
140008	Windshield cleaner hose .....	2	2	2	2	2	2	-	-	-	-
206566	Windshield cleaner intermediate tube right assembly .....	-	-	-	-	-	-	1	1	1	1
206567	Windshield cleaner intermediate tube left assembly .....	-	-	-	-	-	-	1	1	1	1
183463	Windshield cleaner intermediate tube union nut 3/16" .....	-	-	-	-	-	-	2	2	2	2
143360	Clip single .....	-	-	-	-	-	-	2	2	2	2
199787	Screw No. 8 x 1/2" (Parker-Kalon) binding head (Pilot point) .....	-	-	-	-	-	-	2	2	2	2
193388	Windshield cleaner motor complete left ...	-	-	-	-	-	-	1	1	1	1
193389	Windshield cleaner motor complete right ..	-	-	-	-	-	-	1	1	1	1
212564	Windshield cleaner motor complete left ...	1	1	1	1	1	1	-	-	-	-
212565	Windshield cleaner motor complete right ..	1	1	1	1	1	1	-	-	-	-
199138	Windshield cleaner motor attaching nut ...	2	2	2	2	2	2	-	-	-	-
193391	Windshield cleaner motor attaching screw .	-	-	-	-	-	-	4	4	4	4
212460	Windshield cleaner motor attaching screw washer .....	-	-	-	-	-	-	4	4	4	4
206040	Windshield cleaner motor attaching washer.	2	2	2	2	2	2	-	-	-	-
206189	Windshield cleaner motor operating lever knob .....	2	2	2	2	2	2	-	-	-	-
212318	Windshield cleaner motor operating lever knob anti-rattler .....	2	2	2	2	2	2	-	-	-	-
212459	Windshield cleaner motor shaft spacer ....	-	-	-	-	-	-	2	2	2	2
212458	Windshield cleaner motor shaft spacer washer .....	-	-	-	-	-	-	4	4	2	2
212456	Windshield cleaner motor shaft washer ....	-	-	-	-	-	-	2	2	2	2
212457	Windshield cleaner motor shaft washer retainer .....	-	-	-	-	-	-	2	2	2	2
212533	Windshield cleaner motor spacer .....	2	2	2	2	2	2	-	-	-	-
210070	Windshield cleaner vacuum pump dash connection .....	1	1	1	1	1	1	1	1	1	1
7007	Nut 7/16-20 hex. ....	1	1	1	1	1	1	1	1	1	1
5806	Lockwasher 7/16" (Shakeproof) .....	1	1	1	1	1	1	1	1	1	1
3883	Washer 7/16" plain .....	1	1	1	1	1	1	1	1	1	1
209512	Windshield cleaner vacuum pump to dash connection tube assembly .....	1	1	1	1	1	1	1	1	1	1
6261	Nut 1/4" flared tube (inverted) .....	1	1	1	1	1	1	1	1	1	1

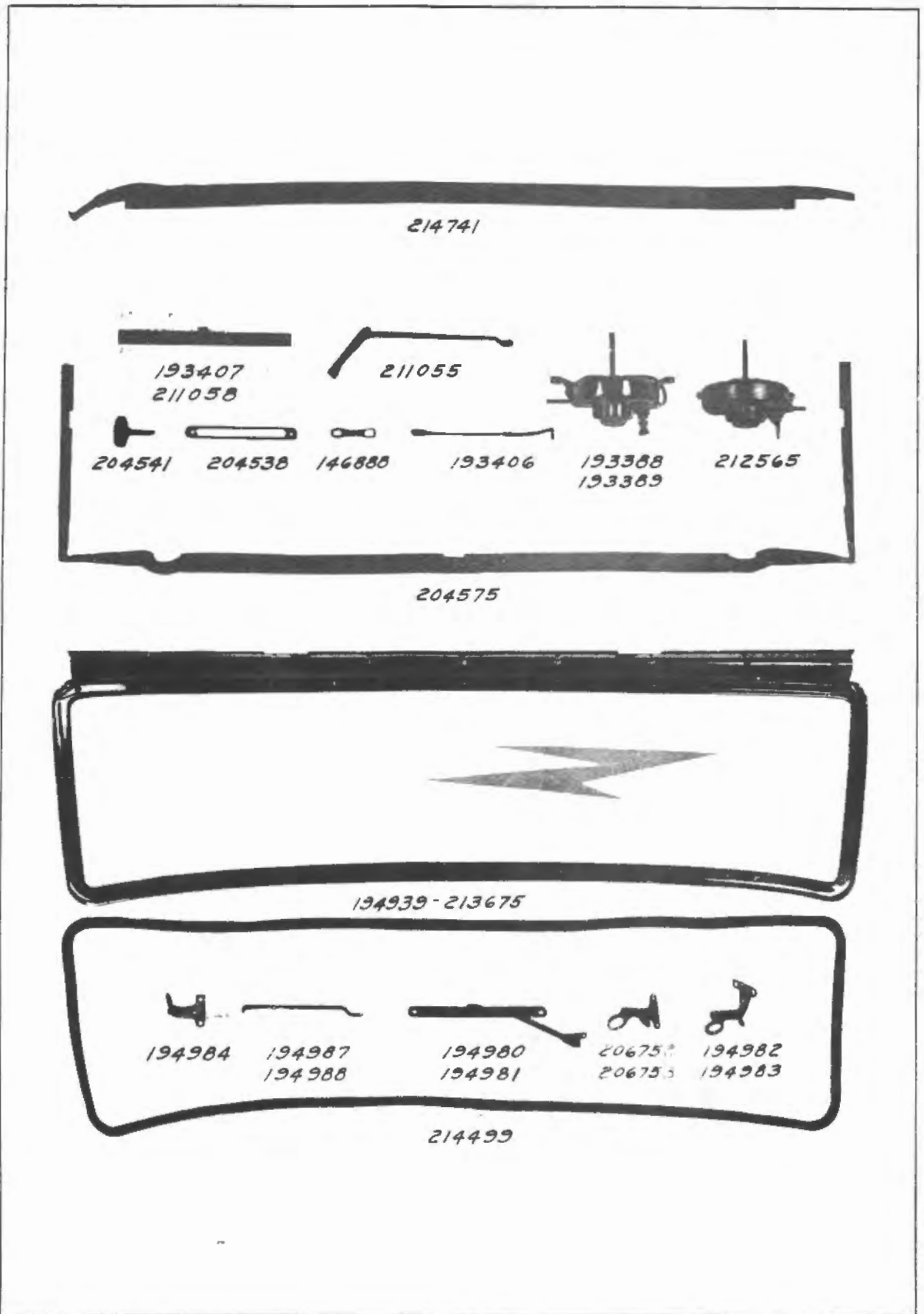

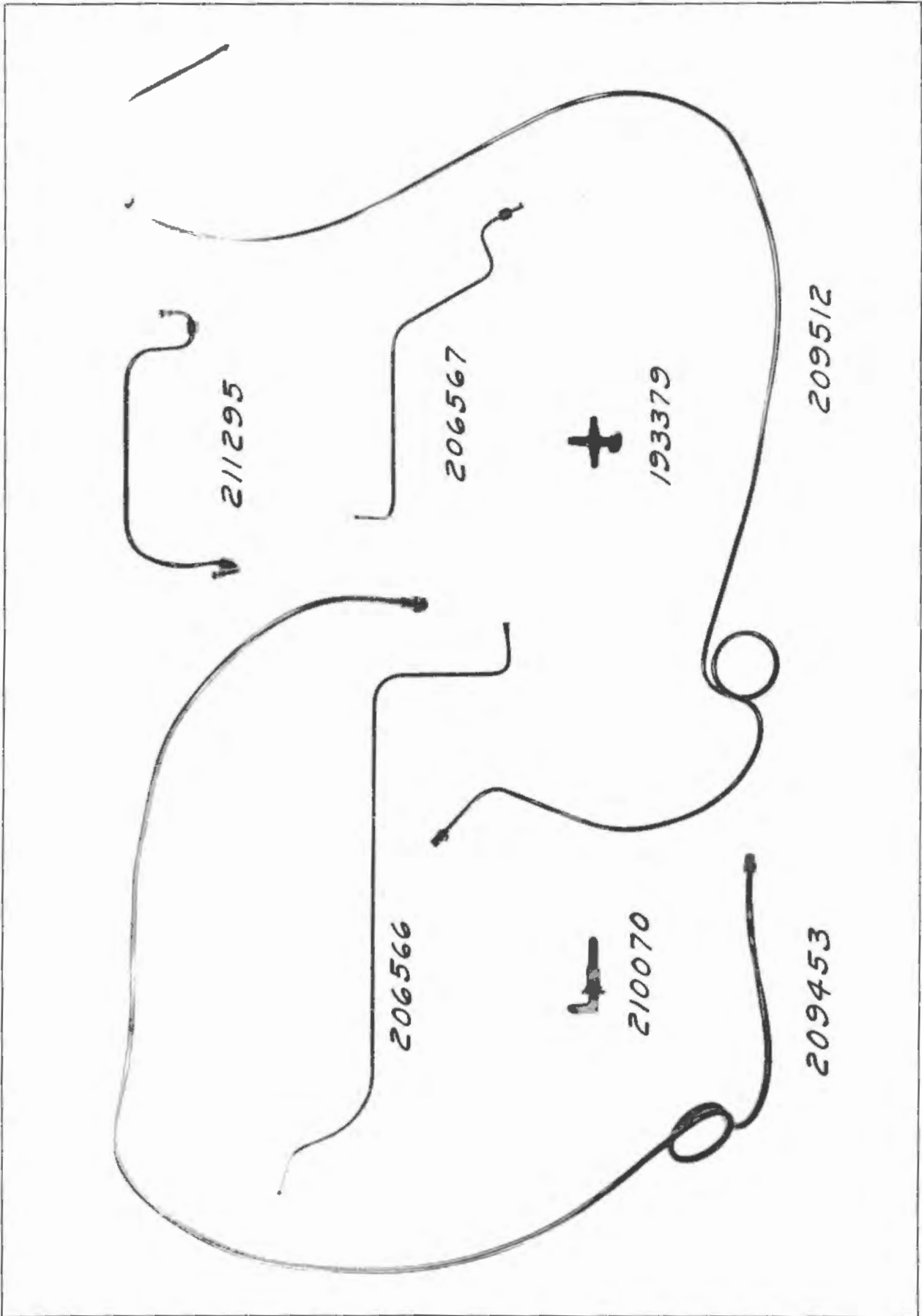



Piece No.	Name	No Required									
		732	733	734	735	736	737	738	739	743	747
6399	Union nut 1/4" flared tube .....	1	1	1	1	1	1	1	1	1	1
6279	Elbow 1/4" flared tube (inverted) ....	1	1	1	1	1	1	1	1	1	1
209578	Clip (style No. 14) .....	1	1	1	1	1	1	1	1	1	1
167261	Screw No. 10 (.187) x 3/8" (Parker-Kalon) .....	1	1	1	1	1	1	1	1	1	1
209453	Windshield cleaner vacuum pump to manifold tube assembly .....	1	1	1	1	1	1	1	1	1	1
6262	Nut 5/16" flared tube (inverted) .....	1	1	1	1	1	1	1	1	1	1
6273	Elbow 5/16" flared tube (inverted) ...	1	1	1	1	1	1	1	1	1	1
5867	Union nut 5/16" flared tube .....	1	1	1	1	1	1	1	1	1	1
209579	Windshield cleaner vacuum pump tube clip .	2	2	2	2	2	2	2	2	2	2
193407	Windshield cleaner wiper .....	-	-	-	-	-	-	2	2	2	2
211058	Windshield cleaner wiper .....	2	2	2	2	2	2	-	-	-	-
193406	Windshield cleaner wiper arm .....	-	-	-	-	-	-	2	2	2	2
211055	Windshield cleaner wiper arm .....	2	2	2	2	2	2	-	-	-	-
146888	Windshield cleaner wiper arm pressure clip	-	-	-	-	-	-	2	2	2	2
214741	Windshield cowl weatherstrip .....	-	-	-	-	-	-	1	1	1	1
206752	Windshield finger pull assembly-right ....	1	1	1	1	1	1	-	-	-	-
206753	Windshield finger pull assembly-left ....	1	1	1	1	1	1	-	-	-	-
194982	Windshield finger pull assembly-left ....	-	-	-	-	-	-	1	1	1	1
194983	Windshield finger pull assembly-right ....	-	-	-	-	-	-	1	1	1	1
194984	Windshield finger pull bracket .....	-	-	-	-	-	-	1	1	1	1
194868	Windshield finger pull cap nut .....	-	-	-	-	-	-	2	2	2	2
194869	Windshield finger pull cap nut spring ....	-	-	-	-	-	-	2	2	2	2
213675	Windshield frame and glass assembly .....	1	1	1	1	1	1	-	-	-	-
194939	Windshield frame and glass assembly .....	-	-	-	-	-	-	1	1	1	1
204549	Windshield glass .....	1	1	1	1	1	1	-	-	-	-
212852	Windshield glass .....	-	-	-	-	-	-	1	1	1	1
206608	Windshield glass cushion thick .....	x	x	x	x	x	x	-	-	-	-
206609	Windshield glass cushion thin .....	x	x	x	x	x	x	-	-	-	-
193436	Windshield header to roof rail weather-strip .....	-	-	-	-	-	-	1	-	-	-
194985	Windshield hinge weatherblock .....	-	-	-	-	-	-	1	1	1	1
204547	Windshield hinge weatherstrip .....	1	1	1	1	1	1	-	-	-	-
193689	Windshield hinge weatherstrip .....	-	-	-	-	-	-	1	1	1	1
206737	Windshield hinge .....	1	1	1	1	1	1	-	-	-	-
206739	Windshield hinge screw .....	13	13	13	13	13	13	-	-	-	-
194981	Windshield locking mechanism-right .....	-	-	-	-	-	-	1	1	1	1
194980	Windshield locking mechanism-left .....	-	-	-	-	-	-	1	1	1	1
194864	Windshield locking mechanism lower screw .	-	-	-	-	-	-	2	2	2	2
194865	Windshield locking mechanism upper screw .	-	-	-	-	-	-	2	2	2	2
194987	Windshield locking mechanism link-right ..	-	-	-	-	-	-	1	1	1	1
194988	Windshield locking mechanism link-left ...	-	-	-	-	-	-	1	1	1	1
194876	Windshield mechanism lock cap screw-right hand .....	-	-	-	-	-	-	1	1	1	1
194986	Windshield mechanism lock cap screw-right hand washer .....	-	-	-	-	-	-	1	1	1	1
204575	Windshield opening weatherstrip .....	1	1	1	1	1	1	-	-	-	-
214499	Windshield sash glass retainer weather-strip .....	1	1	1	1	1	1	-	-	-	-
206734	Windshield sector-right .....	1	1	1	1	1	1	-	-	-	-
211434	Windshield sector-left .....	1	1	1	1	1	1	-	-	-	-
206735	Windshield sector screw .....	2	2	2	2	2	2	-	-	-	-
204538	Windshield sector clamp ferrule .....	2	2	2	2	2	2	-	-	-	-
204546	Windshield sector clamp screw nut .....	2	2	2	2	2	2	-	-	-	-
204544	Windshield sector clamp nut washer-inside.	2	2	2	2	2	2	-	-	-	-
212244	Windshield sector clamp nut washer-outside	2	2	2	2	2	2	-	-	-	-
204541	Windshield sector clamp screw and nut asb.	2	2	2	2	2	2	-	-	-	-
6056	Windshield sector clamp screw lockwasher 3/16" Shakeproof .....	2	2	2	2	2	2	-	-	-	-
204539	Windshield sector clamp spacer .....	2	2	2	2	2	2	-	-	-	-

Piece No.	Name	No. Required									
		732	733	734	735	736	737	738	739	743	747
<b>TRIMMING</b>											
To avoid errors due to difference in texture and shade, please furnish sample when ordering trimming material.											
214951	Assembly-cowl trim panel-right (Specify set number)	-	-	-	1	-	-	-	-	-	-
214952	Assembly-cowl trim panel-left (Specify set number)	-	-	-	1	-	-	-	-	-	
214690	Assembly-cowl trim panel-left (Specify set number)	-	-	-	-	-	-	1	-	-	
214689	Assembly-cowl trim panel-right (Specify set number)	-	-	-	-	-	-	1	-	-	
212620	Assembly-cowl trim panel-right (Specify set number)	1	1	1	-	1	1	-	-	-	
212619	Assembly-cowl trim panel-left (Specify set number)	1	1	1	-	1	1	-	-	-	
214863	Assembly-cowl trim panel-left (Specify set number)	-	-	-	-	-	-	-	1	-	
214862	Assembly-cowl trim panel-right (Specify set number)	-	-	-	-	-	-	-	1	-	
218060	Assembly-door trimming front-left (Specify set number)	-	-	-	1	-	-	-	-	-	
214236	Assembly-door trimming front-left (Specify set number)	-	1	-	-	1	1	-	-	-	
200901	Assembly-door trimming front-left (Specify set number)	-	-	-	-	-	-	-	1	-	
214238	Assembly-door trimming front-left (Specify set number)	1	-	1	-	-	-	-	-	-	
214240	Assembly-door trimming front-left (Specify set number)	-	-	-	-	-	-	1	-	-	
214241	Assembly-door trimming front-right (Specify set number)	-	-	-	-	-	-	1	-	-	
214237	Assembly-door trimming front-right (Specify set number)	-	1	-	-	1	1	-	-	-	
200902	Assembly-door trimming front-right (Specify set number)	-	-	-	-	-	-	-	1	-	
214239	Assembly-door trimming front-right (Specify set number)	1	-	1	-	-	-	-	-	-	
218051	Assembly-door trimming front-right (Specify set number)	-	-	-	1	-	-	-	-	-	
214250	Assembly-door trimming rear-left (Specify set number)	-	1	-	-	1	-	-	-	-	
214252	Assembly-door trimming rear-left (Specify set number)	-	-	1	1	-	-	-	-	-	
218045	Assembly-door trimming rear-left (Specify set number)	1	-	-	-	-	-	-	-	-	
218047	Assembly-door trimming rear-right (Specify set number)	1	-	-	-	-	-	-	-	-	
214251	Assembly-door trimming rear-right (Specify set number)	-	1	-	-	1	-	-	-	-	
214253	Assembly-door trimming rear-right (Specify set number)	-	-	1	1	-	-	-	-	-	
214276	Assembly-headlining (Specify set number)	-	1	-	-	-	-	-	-	-	
214186	Assembly-headlining (Specify set number)	-	-	1	-	-	-	-	-	-	
214277	Assembly-headlining (Specify set number)	-	-	-	-	1	-	-	-	-	
214278	Assembly-headlining (Specify set number)	-	-	-	-	-	-	1	-	-	
214279	Assembly-headlining (Specify set number)	-	-	-	-	-	-	-	1	-	
214809	Assembly-headlining (Specify set number)	x	-	-	-	-	-	-	-	-	

Piece No.	Name	No. Required												
		732	733	734	735	736	737	738	739	743	747			
214280	Assembly-headlining rear (Specify set number) .....	-	-	-	1	-	-	-	-	-	-	-	-	-
139910	Binding cloth wire-on (Specify set number)	-	-	X	X	-	X	X	-	-	-	-	-	-
167438	Binding cloth wire-on (cordless) 1/2" wide (Specify set number) .....	X	X	X	X	X	-	-	-	-	-	-	-	-
192088	Binding imitation leather wire-on colonial grain (undyed backing) .....	-	-	-	-	-	-	-	-	X	-	-	-	-
192037	Binding 1-1/2 leather-skiver grain .....	-	-	-	-	-	X	-	-	-	-	-	-	-
214296	Binding cloth wire-on (cordless) 3/4" wide	-	X	X	-	X	-	-	-	-	-	-	-	-
156689	Binding 1-1/8" leather colonial grain (Specify set number) .....	-	-	-	-	-	-	X	X	-	-	-	-	-
156596	Binding lace 7/16" (Specify set number) ..	-	-	X	X	-	X	X	X	-	-	-	-	-
176578	Binding leather wire-on colonial grain (Specify set number) .....	-	-	-	X	-	-	X	X	-	-	-	-	-
206731	Binding rattan 5/16" half round .....	-	X	X	X	-	-	-	-	-	-	-	-	-
212374	Binding weatherstrip (Specify set number).	X	X	X	X	X	X	X	X	-	-	-	-	-
5579	Brad No. 19 x 3/4" (Taper head) .....	X	X	X	X	X	X	X	X	-	-	-	-	-
6231	Brad No. 20 x 3/8" .....	X	X	X	X	X	X	X	X	-	-	-	-	-
5738	Brad No. 19 x 1/2" (Taper head) .....	X	X	X	X	X	X	X	X	-	-	-	-	-
29595	Burlap 10 oz. 40" wide .....	X	X	X	X	X	X	-	-	-	-	-	-	-
166480	Button mould No. 22 ligne upholsters shell	-	-	-	-	-	-	-	-	16	-	-	-	-
166479	Button mould No. 22 ligne upholsters filler .....	-	-	-	-	-	-	-	-	16	-	-	-	-
166478	Button mould No. 22 ligne upholsters eye	-	-	-	-	-	-	-	-	16	-	-	-	-
184555	Button leather covered upholsters tufting (Specify set number) .....	-	-	-	-	-	-	-	-	16	-	-	-	-
200996	Carpet rubber set 36" wide .....	-	-	-	-	-	X	X	X	-	-	-	-	-
29651	Cloth cotton 36" wide .....	X	X	X	X	X	X	X	X	-	-	-	-	-
185467	Cord 5/64" manilla .....	X	X	X	X	X	X	X	X	-	-	-	-	-
29790	Cord-window curtain guide (Specify set number) .....	X	X	X	X	X	X	X	X	-	-	-	-	-
179401	Cord welt enameled drill .....	X	X	X	X	X	X	X	X	-	-	-	-	-
195209	Cord welt enameled drill .....	X	X	X	X	X	X	X	X	-	-	-	-	-
113822	Cord welt enameled drill .....	-	-	-	-	-	-	-	-	X	-	-	-	-
159187	Cord welt 3/4 x 1/4 colonial leather (Specify set number) .....	-	-	-	X	-	-	X	X	-	-	-	-	-
156696	Cord welt 11/16 x 3/16 leather colonial grain (Specify set number) .....	-	-	-	X	-	-	-	X	-	-	-	-	-
182628	Cord welt seaming lace 3/8 x 3/4 (Specify set number) .....	-	-	-	-	X	-	-	-	-	-	-	-	-
214378	Cord welt seaming lace 9/32 x 1 (Specify set number) .....	X	X	X	X	X	X	-	-	-	-	-	-	-
127253	Cord welt seaming lace 9/32 x 5/8 (Specify set number) .....	X	X	X	X	X	X	X	-	-	-	-	-	-
173243	Cord welt seaming lace 11/16 x 3/16 (Specify set number) .....	X	X	X	X	X	X	X	-	-	-	-	-	-
161787	Drill white cotton 7 oz. 36" wide .....	X	X	X	X	X	X	X	X	-	-	-	-	-
105025	Drill enameled 50" wide-long grain .....	X	X	X	X	X	X	X	X	-	-	-	-	-
200525	Duck-black double filled 1.35-50" .....	X	X	X	X	X	X	X	X	-	-	-	-	-
185211	Fabric 58" upholstering (Specify set number) .....	X	X	X	X	X	X	X	X	-	-	-	-	-
200467	Fabric top material 54" wide .....	-	-	-	-	-	-	-	X	-	-	-	-	-
174513	Fabric 54" filled mole skin .....	X	X	X	X	X	X	X	X	-	-	-	-	-
165641	Fabric-roof covering 45" wide .....	-	X	X	X	X	X	X	-	-	-	-	-	-
184863	Fabric-roof covering 45" wide (Turtlegrain)	X	-	-	-	-	-	-	-	-	-	-	-	-
200065	Fabric roof covering .....	X	X	X	X	X	X	-	-	-	-	-	-	-
204346	Felt-top rear bow filler .....	-	-	-	-	-	-	-	X	-	-	-	-	-
195338	Felt-top bow filler .....	-	-	-	-	-	-	-	X	-	-	-	-	-
156692	Gimp 1/2" imitation black colonial leather	X	X	X	X	X	X	X	X	-	-	-	-	-
175234	Gimp 3/4" leather colonial grain .....	-	-	-	-	-	-	-	X	-	-	-	-	-

Piece No.	Name	No. Required									
		732	733	734	735	736	737	738	739	743	747
206913	Gimp 3/4" leather skiver grain (Specify set number) .....	x	x	x	x	x	x	x	-	-	-
214054	Hair interlaced 52" wide 5 oz. ....	-	-	x	x	-	-	-	x	-	-
163380	Hair pad 36" wide (1/4" all cow hair burlap center) .....	x	x	x	x	x	x	x	x	-	-
127473	Hair Wilson and Co. super bovine grey or its equivalent .....	x	x	x	x	x	x	x	x	-	-
123507	Leather imitation (Textileather Co. No. 95153 color .090 or its equivalent).	-	-	-	-	-	-	x	x	-	-
183986	Leather-Turtlegrain-Landau (black) .....	x	-	-	-	-	-	-	-	-	-
156346	Leather imitation colonial grain (Specify set number) .....	-	-	-	-	-	-	-	x	-	-
156348	Leather trimming (colonial grain) (Specify set number) .....	-	-	-	x	-	-	x	x	-	-
161778	Leather binding (Specify set number) .....	-	x	x	x	-	-	-	-	-	-
192303	Muslin rubber 54" wide .....	x	x	x	x	x	x	x	x	-	-
140935	Paper board 1/2 x 48" .....	x	x	x	x	x	x	x	x	-	-
135117	Paper board shim 1/16 x 1 x 36" .....	x	x	x	x	x	x	x	x	-	-
211171	Plush high pile worsted (Specify set number) .....	x	x	x	x	x	x	-	-	-	-
167422	Rubber riser 3/8" half oval .....	x	x	x	x	x	x	-	x	-	-
140900	Rubber riser 1/4" half round .....	x	x	x	x	x	x	x	-	-	-
113983	Silk curtain 22" wide (Specify set number)	-	x	x	x	x	x	x	-	-	-
29652	Tacks-japanned lace 2 oz. ....	x	x	x	x	x	x	x	x	-	-
106964	Tacks-gimp 3 oz. japanned .....	x	x	x	x	x	x	x	x	-	-
113812	Tacks-gimp 4 oz. japanned .....	x	x	x	x	x	x	x	x	-	-
29657	Tacks-japanned lace 4 oz. ....	x	x	x	x	x	x	x	x	-	-
128467	Tacks-japanned lace 8 oz. ....	-	-	-	-	-	-	x	x	-	-
178961	Tacks-japanned lace 10 oz. ....	-	-	-	-	-	x	-	-	-	-
211930	Tacks-trimmers 2-1/2 oz. galvanized .....	-	-	-	-	-	-	-	x	-	-
211931	Tacks-trimmers 4 oz. galvanized .....	-	-	-	-	-	-	-	x	-	-
211932	Tacks-trimmers 10 oz. galvanized .....	-	-	-	-	-	-	-	x	-	-
29662	Tacks-trimmers 1-1/2 oz. japanned .....	x	x	x	x	x	x	x	x	-	-
29663	Tacks-trimmers 2-1/2 oz. japanned .....	x	x	x	x	x	x	x	x	-	-
29664	Tacks-trimmers 4 oz. japanned .....	x	x	x	x	x	x	x	x	-	-
13666	Tacks-trimmers 10 oz. japanned .....	x	x	x	x	x	x	x	x	-	-
206657	Tacks-upholsters .....	x	x	x	x	-	x	-	-	-	-
206655	Tacks-upholsters shell .....	x	x	x	x	-	x	-	-	-	-
113789	Tacks-gimp 6 oz. japanned .....	x	x	x	x	x	x	x	x	-	-
206656	Tacks-upholsters tack .....	x	x	x	x	-	x	-	-	-	-
29637	Thread No. "EE" spool silk .....	x	x	x	x	x	x	x	x	-	-
192345	Thread No. 18 linen .....	x	x	x	x	x	x	x	x	-	-
192346	Thread No. 25 linen .....	x	x	x	x	x	x	x	x	-	-
29638	Thread "A" spool silk .....	x	x	x	x	x	x	x	x	-	-
29640	Thread "EE" No. 18 or Dean and Sheck No. 12-4 .....	x	x	x	x	x	x	x	x	-	-
127808	Thread Dean and Sheck No. 20-A silk finish	x	x	x	x	x	x	x	x	-	-
200638	Thread No. 80-3 hard finish cotton .....	-	x	x	x	x	x	x	-	-	-
200639	Thread No. 90-3 hard finish cotton .....	-	x	x	x	x	x	x	-	-	-
157022	Thread Lincoln No. 6 .....	x	x	x	x	x	x	x	x	-	-
157586	Thread No. 1201 cord .....	x	x	x	x	x	x	x	x	-	-
29625	Twine No. 252 Yazoo .....	x	x	x	x	x	x	x	x	-	-
192208	Wadding 3" white cotton rolled 3-1/2 oz. .	-	-	-	-	-	-	-	x	-	-
29627	Wadding 33" blue sheet No. 532 .....	x	x	x	x	x	x	x	x	-	-
192209	Wadding 5" white cotton rolled 6 oz. ....	-	-	-	-	-	-	-	x	-	-
158040	Wadding 33" white sheet .....	x	x	x	x	x	x	x	x	-	-
183741	Wadding roof 41" wide .....	x	x	x	x	x	x	x	-	-	-

Piece No.	Name	No. Required										
		732	733	734	735	736	737	738	739	743	747	
193352	Webbing 2" wide elastic .....	-	x	x	x	x	x	x	x	x	-	-
62759	Webbing 3" wide jute .....	x	x	x	x	x	x	x	x	x	-	-
172470	Wadding 4" white cotton unbleached rolled 5 oz. ....	x	x	x	x	x	x	x	x	x	-	-
139457	Wadding white cotton unbleached 6" rolled 7 oz. ....	-	-	-	-	-	-	x	x	-	-	
214212	Wadding 8" white cotton rolled (50% China 50% 1st run linters) (5 oz.) .....	-	-	x	x	-	-	-	-	-	-	
214213	Wadding 8" white cotton rolled (50% China 50% 1st run linters) (9-1/2 oz.) .....	-	-	-	x	-	-	-	-	-	-	
214211	Wadding 5-1/2" white cotton rolled (50% China 50% 1st run linters) (3-1/2 oz.) .	-	-	x	x	-	-	-	-	-	-	
214562	Windlace-cloth (Specify set number) .....	x	x	x	x	x	x	x	-	-	-	
214841	Windlace-cloth (Specify set number) .....	-	-	-	x	-	-	-	x	-	-	



Piece No.	Name	No. Required									
		832 932	833 933	834 934	835 935	836 936	837 937	838 938	839 939	873 973	827 927
<b>BODY ATTACHING PARTS</b>											
7886	Body to frame bolt No. 1 screw 7/16-20 x 1-3/4 hex. hd. ....	2	2	2	2	2	2	2	2	2	2
5282	Body to frame bolt No. 2 screw 7/16-20 x 3-1/2 hex. hd. ....	2	2	2	2	2	2	2	2	2	2
228250	Body to frame bolt No. 2 (inside) screw 7/16-20 x 2-3/8 flat hd. ....	-	-	-	-	-	-	-	2	2	2
5282	Body to frame bolt No. 3 screw 7/16-20 x 3-1/2 hex. hd. ....	2	2	2	2	2	2	2	2	2	2
7834	Body to frame bolt No. 4 screw 7/16-20 x 3-1/8 hex. hd. ....	2	2	2	2	2	-	-	-	4	-
7954	Body to frame bolt No. 4 screw 7/16-20 x 3-1/4 hex. hd. ....	-	-	-	-	-	2	2	2	-	2
7954	Body to frame bolt No. 5 screw 7/16-20 x 3-1/4 hex. hd. ....	4	4	4	4	4	4	4	4	-	4
7834	Body to frame bolt No. 5 screw 7/16-20 x 3-1/8 hex. hd. ....	-	-	-	-	-	-	-	-	4	-
5671	Body to frame bolt No. 6 screw 7/16-20 x 5-3/8 hex. hd. ....	2	2	2	2	2	2	2	2	2	2
7890	Body to frame bolt No. 7 screw 7/16-20 x 1-1/2 hex. hd. ....	2	2	2	2	2	2	2	2	2	2
5380	Body to frame bolt No. 8 screw 7/16-20 x 4-5/8 hex. hd. ....	2	2	2	2	2	2	2	2	2	2
131809	Body to frame bolt washer-large Washer 7/16 special ....	4	4	4	4	4	4	4	4	-	4
131046	Body to frame bolt washer-small Washer 7/16 special ....	26	26	26	26	26	26	26	28	30	28
5508	Body to frame bolt lockwasher 7/16 .....	18	18	18	18	18	18	18	20	22	20
7007	Body to frame bolt-nut 7/16-20 .....	14	14	14	14	14	14	14	16	12	16
185273	Body to frame liner 3/16 thick .....	x	x	x	x	x	x	x	x	x	x
185270	Body to frame liner 3/8 thick .....	x	x	x	x	x	x	x	x	x	x
185274	Body to frame liner 1/4 thick .....	x	x	x	x	x	x	x	x	x	x
226790	Body to frame liner .....	2	2	2	2	2	2	2	2	2	2
185274	Body hold down bolt bracket liner 1/4 thick .....	x	x	x	x	x	x	x	x	x	x
185273	Body hold down bolt bracket liner 3/16 thick .....	x	x	x	x	x	x	x	x	x	x
185270	Body hold down bolt bracket liner 3/8 thick .....	x	x	x	x	x	x	x	x	x	x

**ARM REST**

Always send samples of material when ordering arm rest trimmed assemblies, as the assemblies are upholstered to match the body interior.

224380	Arm rest (trimmed) assembly right .....	1	1	-	-	-	-	-	-	-	-
224381	Arm rest (trimmed) assembly left .....	1	1	-	-	-	-	-	-	-	-
224382	Arm rest (trimmed) assembly right .....	-	-	1	-	-	-	-	-	-	-
224383	Arm rest (trimmed) assembly left .....	-	-	1	-	-	-	-	-	-	-
224384	Arm rest (trimmed) assembly right .....	-	-	-	1	-	-	-	-	-	-
224385	Arm rest (trimmed) assembly left .....	-	-	-	1	-	-	-	-	-	-
226060	Arm rest (trimmed) assembly right .....	-	-	-	-	-	1	-	-	-	-
226061	Arm rest (trimmed) assembly left .....	-	-	-	-	-	1	-	-	-	-
224994	Arm rest (trimmed) assembly right .....	-	-	-	-	1	-	-	-	-	-
224995	Arm rest (trimmed) assembly left .....	-	-	-	-	1	-	-	-	-	-
5963	Arm rest attaching screw 1/4-28 x 7/16 ...	2	2	2	2	4	-	-	-	-	-
193730	Screw ferrule 1/4 .....	2	2	2	2	4	-	-	-	-	-

Piece No.	Name	No. Required										
		832 932	833 933	834 934	835 935	836 936	837 937	838 938	839 939	873 973	827 927	
226382	Arm rest cushion right .....	-	-	-	-	-	1	-	-	-	-	-
226372	Arm rest cushion right .....	1	1	-	-	-	-	-	-	-	-	-
224952	Arm rest cushion left .....	-	-	-	-	1	-	-	-	-	-	-
224999	Arm rest cushion left .....	-	-	-	-	-	1	-	-	-	-	-
224679	Arm rest cushion left .....	1	1	-	-	-	-	-	-	-	-	-
226370	Arm rest cushion right .....	-	-	1	1	-	-	-	-	-	-	-
226387	Arm rest cushion right .....	-	-	-	-	1	-	-	-	-	-	-
224672	Arm rest cushion left .....	-	-	1	1	-	-	-	-	-	-	-
211026	Arm rest smoking case ash receiver .....	2	2	2	2	-	2	-	-	-	-	-
224647	Arm rest smoking case ash receiver right .	-	-	-	-	-	-	-	-	1	1	-
227757	Arm rest smoking case ash receiver left ..	-	-	-	-	-	-	-	-	1	1	-
224509	Arm rest smoking case cigar lighter complete .....	2	2	2	2	-	2	-	-	-	-	-
211191	Arm rest smoking case cigar lighter .....	2	2	2	2	-	2	-	-	1	1	-
182377	Arm rest smoking case cigar lighter tip ..	2	2	2	2	-	2	-	-	-	-	-
224512	Arm rest smoking case cover plate-right ..	1	1	-	-	-	1	-	-	-	-	-
224492	Arm rest smoking case cover plate-right ..	-	-	1	1	-	-	-	-	-	-	-
224513	Arm rest smoking case cover plate-left ...	1	1	-	-	-	1	-	-	-	-	-
224491	Arm rest smoking case cover plate-left ...	-	-	1	1	-	-	-	-	-	-	-
227810	Arm rest smoking case cover plate .....	-	-	-	-	-	-	-	-	1	1	-
227808	Arm rest vanity case cover plate .....	-	-	-	-	-	-	-	-	1	1	-
224262	Arm rest vanity case memo book .....	1	1	1	1	1	-	-	-	1	1	-
180082	Arm rest vanity case memo book pencil ....	1	1	1	1	1	-	-	-	1	1	-
224629	Arm rest vanity case mirror .....	1	1	1	1	-	1	-	-	-	-	-
224263	Arm rest vanity case mirror .....	-	-	-	-	-	-	-	-	1	1	-

## DASH PANEL

220988	Dash panel assembly .....	1	1	1	1	1	1	1	1	1	1	1
224150	Dash panel body to frame bolt bracket liner 2 x 13-1/2 .....	2	2	2	2	2	2	2	2	2	2	2
224123	Dash panel bonnet dash liner-side .....	2	2	2	2	2	2	2	2	2	2	2
224124	Dash panel bonnet dash liner-top .....	2	2	2	2	2	2	2	2	2	2	2
228280	Dash panel bonnet dash liner hook .....	4	4	4	4	4	4	4	4	4	4	4
229340	Washer 3/16 special .....	4	4	4	4	4	4	4	4	4	4	4
7002	Nut No. 8-32 thd. ....	4	4	4	4	4	4	4	4	4	4	4
228251	Dash panel bonnet dash liner hook saddle .	4	4	4	4	4	4	4	4	4	4	4
187803	Dash panel bonnet dash liner-staple .....	6	6	6	6	6	6	6	6	6	6	6
228246	Dash panel bonnet dash liner-staple saddle .....	6	6	6	6	6	6	6	6	6	6	6

## DOORS

All doors must be adjusted to each respective body. To obtain satisfactory replacement of doors, it is advisable to return the damaged door to be repaired, if possible. If this cannot be done, the customer assumes the responsibility of the new door being a satisfactory fit. Specify on all orders the upholstery material, color and striping.

228376	Door (front right trimmed) assembly .....	-	-	-	-	1	-	-	-	-	-	-
228377	Door (front right trimmed) assembly .....	-	-	-	-	-	-	-	1	-	-	-
228378	Door (front left trimmed) assembly .....	-	-	-	-	1	-	-	-	-	-	-
228379	Door (front left trimmed) assembly .....	-	-	-	-	-	-	-	1	-	-	-
228381	Door (front right trimmed) assembly .....	1	1	1	1	-	-	-	-	-	-	-
228382	Door (front right trimmed) assembly .....	-	-	-	-	-	-	1	-	-	-	-
228383	Door (front right trimmed) assembly .....	-	-	-	-	-	1	-	-	-	-	-
228384	Door (front left trimmed) assembly .....	1	1	1	1	-	-	-	-	-	-	-
228385	Door (front left trimmed) assembly .....	-	-	-	-	-	-	1	-	-	-	-



Piece No.	Name	No. Required									
		832 932	833 933	834 934	835 935	846 936	837 937	838 938	839 939	875 975	827 927
228386	Door (front left trimmed) assembly .....	-	-	-	-	-	1	-	-	-	-
228388	Door (rear right trimmed) assembly .....	-	1	-	-	-	-	-	-	-	-
228390	Door (rear left trimmed) assembly .....	-	1	-	-	-	-	-	-	-	-
228391	Door (rear right trimmed) assembly .....	-	-	1	1	-	-	-	-	-	-
228392	Door (rear right trimmed) assembly .....	1	-	-	-	-	-	-	-	-	-
228393	Door (rear right trimmed) assembly .....	-	-	-	-	1	-	-	-	-	-
228394	Door (rear left trimmed) assembly .....	-	-	1	1	-	-	-	-	-	-
228395	Door (rear left trimmed) assembly .....	1	-	-	-	-	-	-	-	-	-
228396	Door (rear left trimmed) assembly .....	-	-	-	-	1	-	-	-	-	-

DOOR ARM REST

206614	Door arm rest trimmed assembly right (Specify set number) .....	1	1	1	-	1	1	1	-	-	-
206616	Door arm rest trimmed assembly right (Specify set number) .....	-	-	-	1	-	-	-	1	-	-
206615	Door arm rest trimmed assembly left (Specify set number) .....	-	-	-	1	-	-	-	1	-	-
206613	Door arm rest trimmed assembly left (Specify set number) .....	1	1	1	-	1	1	1	-	-	-
206542	Door arm rest cushion right .....	1	1	1	1	1	1	1	1	-	-
206543	Door arm rest cushion left .....	1	1	1	1	1	1	1	1	-	-

DOOR PARTS

199167	Door anti-rattler .....	4	4	4	4	4	2	2	-	-	-
227888	Door anti-rattler .....	-	-	-	-	-	-	-	2	2	2
218305	Door anti-rattler shim .....	x	x	x	x	x	x	x	-	-	-
227890	Door bumper upper long .....	-	-	-	-	-	-	-	x	x	x
227891	Door bumper upper medium .....	-	-	-	-	-	-	-	x	x	x
227889	Door bumper upper short .....	-	-	-	-	-	-	-	x	x	x
226760	Door bumper 1-7/32 (rear lower) .....	x	x	x	x	x	-	-	-	-	-
226762	Door bumper 1-9/32 (rear lower) .....	x	x	x	x	x	-	-	-	-	-
226761	Door bumper 1-11/32 (rear lower) .....	x	x	x	x	x	-	-	-	-	-
227886	Door bumper (rear lower) .....	-	-	-	-	-	-	-	-	x	-
185601	Door bumper 1-11/32 (front lower and rear upper) .....	x	x	x	x	x	x	x	x	x	x
185600	Door bumper 1-13/32 (front lower and rear upper) .....	x	x	x	x	x	x	x	x	x	x
218685	Door bumper 1-15/32 (front lower and rear upper) .....	x	x	x	x	x	x	x	x	x	x
185602	Door bumper 1-9/32 (front lower and rear upper) .....	x	x	x	x	x	x	x	x	x	x
224172	Door bumper front-upper-long .....	x	x	x	x	x	x	x	-	-	-
228200	Door bumper front-upper-short .....	x	x	x	x	x	x	x	-	-	-
227898	Door bumper retainer upper .....	-	-	-	-	-	-	-	2	4	2
6347	Screw No. 8-32 x 1/4 flat hd. ....	-	-	-	-	-	-	-	2	-	-
227894	Door check strap .....	-	-	-	-	-	-	-	-	4	2
224121	Door check strap-front .....	2	2	2	2	2	2	2	2	-	-
164700	Door check strap-rear .....	2	2	2	2	2	-	-	-	-	-
224157	Door check strap fastener plate front ...	2	2	2	2	2	2	2	-	-	-
227893	Door check strap fastener plate front ...	-	-	-	-	-	-	-	2	4	2
8224	Screw No. 10-32 x 5/8 flat hd. ....	4	4	4	4	4	4	4	-	-	-
8207	Screw No. 10-32 x 3/4 flat hd. ....	4	4	4	4	4	4	4	-	-	-
5735	Screw No. 10-32 x 5/8 round hd. ....	-	-	-	-	-	-	-	4	8	4
164359	Door check strap fastener plate rear ....	2	2	2	2	2	-	-	-	-	-
227896	Door check strap ferrule .....	-	-	-	-	-	-	-	-	2	2
199965	Door check strap guide assembly .....	2	2	4	4	4	2	2	-	-	-
229326	Door check strap guide assembly-rear ....	2	2	-	-	-	-	-	-	-	-

Piece No.	Name	No. Required									
		832 932	833 933	834 934	835 935	836 936	837 937	838 938	839 939	873 973	827 927
227897	Door check strap guide assembly .....	-	-	-	-	-	-	-	2	4	2
224171	Door dove-tail female-front .....	2	2	2	2	2	2	2	2	2	2
224170	Door dove-tail female-rear .....	2	2	2	2	2	-	-	-	2	-
224169	Door dove-tail male-front .....	4	4	4	4	4	4	4	4	4	4
224169	Door dove-tail male-rear .....	2	2	2	2	2	-	-	-	2	-
227630	Door hinge lower assembly .....	-	-	-	-	-	-	-	-	2	-
227624	Door hinge upper assembly .....	-	-	-	-	-	-	-	-	2	-
224105	Door hinge front lower right .....	1	1	1	1	1	1	-	-	-	-
227642	Door hinge front lower right .....	-	-	-	-	-	-	-	1	-	1
224104	Door hinge front lower left .....	1	1	1	1	1	1	-	-	-	-
227643	Door hinge front lower left .....	-	-	-	-	-	-	-	1	-	1
224088	Door hinge front upper right .....	1	1	1	1	1	1	-	-	-	-
227636	Door hinge front upper right .....	-	-	-	-	-	-	-	1	-	1
224089	Door hinge front upper left .....	1	1	1	1	1	1	-	-	-	-
227637	Door hinge front upper left .....	-	-	-	-	-	-	-	1	-	1
224101	Door hinge rear lower right .....	-	-	1	1	1	-	-	-	-	-
226777	Door hinge lower right .....	-	-	-	-	-	-	1	-	-	-
224100	Door hinge rear lower left .....	-	-	1	1	1	-	-	-	-	-
226775	Door hinge lower left .....	-	-	-	-	-	-	1	-	-	-
224107	Door hinge rear lower right .....	1	1	-	-	-	-	-	-	-	-
224106	Door hinge rear lower left .....	1	1	-	-	-	-	-	-	-	-
224103	Door hinge rear upper right .....	-	1	1	1	-	-	-	-	-	-
229224	Door hinge rear upper right .....	1	-	-	-	1	-	-	-	-	-
226745	Door hinge upper right .....	-	-	-	-	-	-	1	-	-	-
224102	Door hinge rear upper left .....	-	1	1	1	-	-	-	-	-	-
229223	Door hinge rear upper left .....	1	-	-	-	1	-	-	-	-	-
226744	Door hinge upper left .....	-	-	-	-	-	-	1	-	-	-
6459	Door hinge front screw 1/4-28 x 1-5/8 oval hd. ....	4	4	4	4	4	-	-	-	-	-
229446	Screw 5/16-24 x 5/8 flat hd. special.	-	-	-	-	-	-	-	4	-	4
228204	Screw 5/16-24 x 1-1/2 flat hd. special .....	-	-	-	-	-	-	-	4	-	4
228205	Screw 5/16-24 x 2-3/8 flat hd. special .....	-	-	-	-	-	-	-	6	-	6
8211	Screw 1/4-28 x 2-1/4 flat hd. ....	2	2	2	2	2	2	2	-	-	-
227916	Screw 5/16-24 x 3 flat hd. special ..	-	-	-	-	-	-	-	2	-	2
227915	Screw 5/16-24 x 17/32 flat hd. special .....	-	-	-	-	-	-	-	16	-	16
5854	Screw 1/4-28 x 1-1/4 flat hd. ....	2	2	2	2	2	2	2	-	-	-
8005	Screw 1/4-28 x 5/8 oval hd. ....	4	4	4	4	4	4	4	-	-	-
224887	Washer countersunk (Shakeproof) .....	-	-	-	-	-	-	-	32	-	32
227926	Washer countersunk (Shakeproof) .....	-	-	-	-	-	-	-	-	32	32
5899	Lockwasher 5/16 countersunk (Shakeproof) .....	4	4	4	4	4	4	4	-	-	-
5820	Screw 1/4-28 x 1-31/32 oval hd. ....	-	-	-	-	-	4	4	-	-	-
5854	Door hinge rear screw 1/4-28 x 1-1/4 flat hd. ....	4	4	4	4	4	-	-	-	-	-
5820	Screw 1/4-28 x 1-31/32 oval hd. ....	4	4	4	4	4	-	-	-	-	-
224090	Door hinge pin .....	8	8	8	8	8	4	4	-	-	-
227603	Door hinge pin .....	-	-	-	-	-	-	-	4	4	4
230300	Door hinge pin bushing .....	x	x	x	x	x	x	x	x	-	-
227601	Door hinge pin screw .....	-	-	-	-	-	-	-	4	4	4
218600	Door hinge pin screw .....	8	8	8	8	8	4	4	-	-	-
5500	Lockwasher No. 10 .....	8	8	8	8	8	4	4	-	-	-
229345	Door lock-front left .....	1	1	1	1	1	1	1	1	-	-
229344	Door lock-front right .....	1	1	1	1	1	1	1	1	-	-
229344	Door lock-front right .....	-	-	-	-	-	-	-	-	1	1
229345	Door lock-front left .....	-	-	-	-	-	-	-	-	1	1
183170	Door lock-rear right .....	-	-	-	-	-	-	-	-	1	-
183171	Door lock-rear left .....	-	-	-	-	-	-	-	-	1	-
183171	Door lock-rear right .....	1	1	1	1	1	-	-	-	-	-
183170	Door lock-rear left .....	1	1	1	1	1	-	-	-	-	-
5829	Screw No. 10-32 x 7/8 flat hd. ....	8	8	8	8	8	4	4	-	-	-

SERVICE PARTS LIST—PACKARD TWELVE

Door Part 386-A

Piece No.	Name	No. Required									
		832 932	833 933	834 934	835 935	836 936	837 937	838 938	839 (939)	873 973	827 927
5491	Lockwasher 3/16 countersunk (Shakeproof) .....	8	8	8	8	8	4	4	-	-	-
220958	Door lock handle front right (With key lock) .....	1	1	1	1	1	1	1	-	-	-
227712	Door lock handle front right (With key lock) .....	-	-	-	-	-	-	-	1	1	1
220955	Door lock handle front left .....	1	1	1	1	1	1	1	-	-	-
227727	Door lock handle front left .....	-	-	-	-	-	-	-	1	1	1
220957	Door lock handle rear right .....	-	1	1	-	1	-	-	-	-	-
227710	Door lock handle rear right .....	-	-	-	-	-	-	-	-	1	-
227720	Door lock handle rear right (With key lock) .....	-	-	-	-	-	-	-	-	1	-
227711	Door lock handle rear left .....	-	-	-	-	-	-	-	-	1	-
220956	Door lock handle rear left .....	1	1	1	1	1	-	-	-	-	-
220959	Door lock handle rear right (With key lock) .....	1	-	-	1	-	-	-	-	-	-
206188	Door lock handle attaching plate (Locking handle) .....	2	1	1	2	1	1	1	1	-	-
206223	Door lock handle attaching plate .....	2	3	3	2	3	1	1	1	-	-
206187	Door lock handle escutcheon plate .....	4	4	4	4	4	2	2	2	4	2
206017	Door lock handle screw (Locking handle) .	x	x	x	x	x	x	x	x	x	x
212168	Door lock handle screw (Locking handle) .	x	x	x	x	x	x	x	x	x	x
206043	Door lock handle screw (Locking handle) .	x	x	x	x	x	x	x	x	x	x
185236	Door lock handle screw washer (Locking handle) .....	2	1	1	2	1	1	1	1	1	1
220532	Door lock remote control rear right .....	-	-	1	1	1	-	-	-	-	-
224708	Door lock remote control rear right .....	1	1	-	-	-	-	-	-	-	-
220531	Door lock remote control rear left .....	-	-	1	1	1	-	-	-	-	-
224709	Door lock remote control rear left .....	1	1	-	-	-	-	-	-	-	-
226515	Door lock remote control handle .....	4	4	4	4	4	2	2	2	4	2
224539	Door lock remote control handle escutcheon plate .....	4	4	4	4	4	2	2	2	4	2
193078	Door lock remote control handle escutcheon plate spring .....	4	4	4	4	4	2	2	2	4	2
0239525	Door lock remote control front spring ...	2	2	2	2	2	2	2	2	2	2
220980	Door lock striker .....	4	4	4	4	4	2	2	2	4	2
211539	Door pull to handle (metal) .....	1	1	1	1	1	1	1	1	-	-
229354	Door pull to handle (cloth - loop type) .	1	1	1	1	1	1	1	1	-	-
224932	Door scuff plate front lower right .....	-	-	-	-	-	1	1	-	-	-
224933	Door scuff plate front lower left .....	-	-	-	-	-	1	1	-	-	-
224313	Door scuff plate front lower right .....	-	-	-	-	1	-	-	-	-	-
224314	Door scuff plate front lower left .....	-	-	-	-	1	-	-	-	-	-
227728	Door scuff plate front upper right .....	-	-	-	-	-	-	-	-	1	-
227729	Door scuff plate front upper left .....	-	-	-	-	-	-	-	-	1	-
224317	Door scuff plate front lower right .....	1	1	1	1	-	-	-	1	1	1
224318	Door scuff plate front lower left .....	1	1	1	1	-	-	-	1	1	1
224401	Door scuff plate front upper right .....	-	-	-	-	1	-	-	-	-	-
227724	Door scuff plate front upper right .....	-	-	-	-	-	-	-	1	-	1
224402	Door scuff plate front upper left .....	-	-	-	-	1	-	-	-	-	-
227725	Door scuff plate front upper left .....	-	-	-	-	-	-	-	1	-	1
224405	Door scuff plate front upper right .....	1	1	1	1	-	1	1	-	-	-
224406	Door scuff plate front upper left .....	1	1	1	1	-	1	1	-	-	-
224287	Door scuff plate rear lower .....	2	2	-	-	-	-	-	-	-	-
224307	Door scuff plate rear lower right .....	-	-	1	1	1	-	-	-	1	-
224308	Door scuff plate rear lower left .....	-	-	1	1	1	-	-	-	1	-
226262	Door scuff plate rear upper right .....	1	1	-	-	-	-	-	-	-	-
227738	Door scuff plate rear upper right .....	-	-	-	-	-	-	-	-	1	-
227739	Door scuff plate rear upper left .....	-	-	-	-	-	-	-	-	1	-
226261	Door scuff plate rear upper left .....	1	1	-	-	-	-	-	-	-	-
224407	Door scuff plate rear upper right .....	-	-	1	1	1	-	-	-	-	-
224408	Door scuff plate rear upper left .....	-	-	1	1	1	-	-	-	-	-
227839	Door striker rear door bottom .....	-	-	-	-	-	-	-	-	2	-
228238	Door weatherstrip-tan color .....	-	-	-	-	-	-	-	-	x	-
228239	Door weatherstrip-black color .....	-	-	-	-	-	-	-	-	x	-



Piece No.	Name	No. Required									
		832 942	833 943	834 944	835 945	836 946	837 937	838 938	839 939	871 971	827 927
<b>ELECTRICAL</b>											
167069	Electrical body wiring cable (19 strand No. 16 Ga. green braid) (Bulk stock) ...	x	x	x	x	x	x	x	x	-	-
179251	Electrical body wiring cable (19 strand No. 12 Ga. green braid) (Bulk stock) ...	x	x	x	x	x	x	-	-	-	-
166403	Electrical body wiring cable (19 strand No. 12 Ga. red braid) (Bulk stock) .....	x	x	x	x	x	x	-	-	-	-
166406	Electrical body wiring cable (19 strand No. 16 Ga. red braid) (Bulk stock) .....	x	x	x	x	x	x	x	x	-	-
166404	Electrical body wiring cable (19 strand No. 16 Ga. black braid) (Bulk stock) ...	x	x	x	x	x	x	x	x	-	-
166405	Electrical body wiring cable (19 strand No. 16 Ga. black with red tracer braid) (Bulk stock) .....	x	x	x	x	x	x	x	-	-	-
201736	Electrical body wiring cable connector tip male .....	x	x	x	x	x	x	x	-	-	-
224442	Electrical body wiring cable groove clip .	x	x	x	x	x	-	-	-	-	-
29254	Electrical body wiring cable staple insulated No. 1 x 1/2 .....	x	x	x	x	x	x	x	x	-	-
147649	Electrical dictograph receiver (round type) .....	-	-	-	1	-	-	-	-	-	-
229456	Electrical dictograph receiver (flat type)	-	-	-	1	-	-	-	-	-	-
228038	Electrical dictograph receiver to body fuse cable assembly .....	-	-	-	1	-	-	-	-	-	-
211003	Electrical dictograph transmitter and winder assembly .....	-	-	-	1	-	-	-	-	-	-
133004	Electrical dictograph winder .....	-	-	-	1	-	-	-	-	-	-
5696	Screw No. 8-32 x 3/8" round hd. ....	-	-	-	2	-	-	-	-	-	-
5695	Lockwasher No. 8 .....	-	-	-	2	-	-	-	-	-	-
7002	Nut No. 8-32 .....	-	-	-	2	-	-	-	-	-	-
224265	Electrical dictograph winder bracket .....	-	-	-	1	-	-	-	-	-	-
5853	Screw 1/4-28 x 1/2" round hd. ....	-	-	-	1	-	-	-	-	-	-
5502	Lockwasher 1/4 .....	-	-	-	1	-	-	-	-	-	-
7004	Nut 1/4-28 .....	-	-	-	1	-	-	-	-	-	-
224560	Electrical dome light .....	-	1	1	-	1	1	1	-	-	-
224560	Electrical dome light front .....	1	-	-	1	-	-	-	-	-	-
224561	Electrical dome light rear .....	1	-	-	1	-	-	-	-	-	-
102585	Electrical dome light bulb (Mazda No. 81) 6 CPG-6 .....	3	1	1	3	1	1	1	-	-	-
220761	Electrical dome light door switch .....	2	2	2	2	2	2	2	-	-	-
224476	Electrical dome light door switch cable assembly .....	-	-	-	1	-	-	-	-	-	-
226385	Electrical dome light door switch cable assembly .....	-	-	-	-	-	-	1	-	-	-
226384	Electrical dome light door switch cable assembly .....	-	-	-	-	-	1	-	-	-	-
226383	Electrical dome light door switch cable assembly .....	1	-	-	-	-	-	-	-	-	-
224437	Electrical dome light door switch cable assembly .....	-	1	-	-	-	-	-	-	-	-
224856	Electrical dome light door switch cable assembly .....	-	-	-	-	1	-	-	-	-	-
224440	Electrical dome light door switch cable assembly .....	-	-	1	-	-	-	-	-	-	-
224598	Electrical dome light glass and rim .....	2	1	1	2	1	1	1	-	-	-
182459	Electrical dome light (front) instrument board switch (2 point) .....	1	-	-	1	-	-	-	-	-	-
184796	Electrical dome light (rear) instrument board switch (3 point) .....	1	-	-	-	-	-	-	-	-	-

Piece No.	Name	No. Required										
		832 932	833 933	834 934	835 935	836 936	837 937	838 938	839 939	873 973	827 927	
185616	Electrical dome light reflector (2 sockets) .....	-	-	-	1	-	-	-	-	-	-	-
180636	Electrical dome light reflector (1 socket) .....	1	1	1	1	1	1	1	-	-	-	-
224554	Electrical dome light switch (3 point) ...	1	1	1	2	1	1	1	-	-	-	-
224559	Electrical rear quarter light .....	2	2	2	2	2	2	-	-	-	-	
6400	Screw No. 10-32 x 1" flat hd. ....	2	2	2	2	2	2	-	-	-	-	
102590	Electrical rear quarter light bulb 7V - 3 CP G-6 single contact .....	2	2	2	2	2	2	-	-	-	-	
224597	Electrical rear quarter light glass and rim .....	2	2	2	2	2	2	-	-	-	-	
224550	Electrical rear quarter light switch (2 point) .....	1	1	1	1	1	1	-	-	-	-	
102590	Electrical rumble seat compartment light bulb 7V single contact .....	-	-	-	-	-	-	1	1	-	-	
107654	Electrical rumble seat compartment light disconnecter plug socket .....	-	-	-	-	-	-	1	1	-	-	
136593	Electrical rumble seat compartment light switch (2 point) .....	-	-	-	-	-	-	1	1	-	-	
220761	Electrical running board light door switch	-	-	-	-	-	-	-	2	-	-	

## FLOOR BOARD

220769	Floor board-front assembly .....	1	1	1	1	1	1	1	1	1	1
185832	Floor board-front washer .....	4	4	4	4	4	4	4	4	4	4
7906	Screw 1/4-28 x 3/4 round hd. ....	2	2	2	2	2	2	2	2	2	2
5502	Lockwasher 1/4 .....	2	2	2	2	2	2	2	2	2	2
224163	Floor board-rear assembly .....	1	1	1	1	-	-	-	-	-	-
224651	Floor board-rear assembly .....	-	-	-	-	1	-	-	-	-	-
229334	Floor board-rear battery lid assembly ....	1	1	1	1	1	1	1	1	1	1
229349	Floor board battery lid weatherstrip .....	1	1	1	1	1	1	1	1	1	1
187597	Floor board-rear-cutout plate .....	1	1	1	1	-	-	1	1	-	-
224600	Floor board-rear-cutout plate .....	-	-	-	-	-	1	-	-	-	-

## FOLDING SEAT

NOTE: Always send samples of material when ordering trimmed assemblies, as the assemblies are upholstered to match the body interior.

226263	Folding seat trimmed assembly .....	1	-	-	-	-	-	-	-	-	-
224523	Folding seat trimmed assembly .....	-	-	2	2	-	-	-	-	-	-
184270	Folding seat untrimmed assembly .....	1	-	-	-	-	-	-	-	-	-
224065	Folding seat untrimmed assembly .....	-	-	2	2	-	-	-	-	-	-
224154	Folding seat back untrimmed assembly .....	-	-	2	2	-	-	-	-	-	-
184853	Folding seat back untrimmed assembly .....	1	-	-	-	-	-	-	-	-	-
185113	Folding seat back to seat frame screw ....	-	-	4	4	-	-	-	-	-	-
184268	Folding seat back to seat frame screw ....	2	-	-	-	-	-	-	-	-	-
172294	Folding seat cushion spring .....	-	-	2	2	-	-	-	-	-	-
211377	Folding seat floor carpet assembly .....	-	-	2	2	-	-	-	-	-	-
220932	Folding seat floor plate assembly .....	-	-	1	1	-	-	-	-	-	-
224064	Folding seat frame assembly .....	-	-	2	2	-	-	-	-	-	-
5580	Screw No. 10-32 x 1 flat hd. ....	-	-	16	16	-	-	-	-	-	-
5229	Screw 1/4-28 x 1-3/8 flat hd. ....	-	-	8	8	-	-	-	-	-	-
8220	Screw 1/4-28 x 1-1/2 flat hd. ....	-	-	8	8	-	-	-	-	-	-
7003	Nut No. 10-32 .....	-	-	16	16	-	-	-	-	-	-
7004	Nut 1/4-28 .....	-	-	16	16	-	-	-	-	-	-

Piece No.	Name	No. Required										
		832 932	833 933	834 934	835 935	836 936	837 937	838 938	839 939	873 973	827 927	
3867	Washer 3/16 special .....	-	-	4	4	-	-	-	-	-	-	-
185118	Folding seat frame side right .....	-	-	2	2	-	-	-	-	-	-	-
185111	Folding seat frame side left .....	-	-	2	2	-	-	-	-	-	-	-
228150	Folding seat handle assembly .....	-	-	2	2	-	-	-	-	-	-	-
211539	Folding seat handle .....	1	-	-	-	-	-	-	-	-	-	-
224068	Folding seat handle clip .....	-	-	4	4	-	-	-	-	-	-	-
100100	Folding seat pivot pin .....	-	-	4	4	-	-	-	-	-	-	-
187421	Folding seat pivot pin retainer .....	-	-	2	2	-	-	-	-	-	-	-
8204	Screw 1/4-28 x 2 flat hd. ....	-	-	4	4	-	-	-	-	-	-	-
184851	Folding seat support right assembly .....	1	-	-	-	-	-	-	-	-	-	-
184852	Folding seat support left assembly .....	1	-	-	-	-	-	-	-	-	-	-
185114	Folding seat support to seat frame screw .	-	-	4	4	-	-	-	-	-	-	-
7006	Nut 3/8-24 .....	-	-	4	4	-	-	-	-	-	-	-
5506	Lockwasher 3/8" .....	-	-	4	4	-	-	-	-	-	-	-

FOOT REST

224562	Foot rest assembly (Specify set number) ..	-	1	1	1	-	-	-	-	-	-	-
79574	Foot rest assembly .....	-	-	-	-	-	-	1	1	-	-	-
206133	Foot rest bar .....	-	1	1	1	-	-	-	-	-	-	-
206134	Foot rest bar cushion .....	-	1	1	1	-	-	-	-	-	-	-
224555	Foot rest bar end bracket-right .....	-	1	1	1	-	-	-	-	-	-	-
224556	Foot rest bar end bracket-left .....	-	1	1	1	-	-	-	-	-	-	-
224534	Foot rest bar end to support screw .....	-	2	2	2	-	-	-	-	-	-	-
195201	Washer .....	-	2	2	2	-	-	-	-	-	-	-
6048	Lockwasher 3/8 .....	-	2	2	2	-	-	-	-	-	-	-
122146	Foot rest pivot stud .....	-	-	-	-	-	-	2	2	-	-	-
180134	Nut-blind .....	-	-	-	-	-	-	2	2	-	-	-
224558	Foot rest support .....	-	2	2	2	-	-	-	-	-	-	-
224574	Foot rest support bracket .....	-	2	2	2	-	-	-	-	-	-	-
147114	Foot rest support bracket .....	-	-	-	-	-	-	2	2	-	-	-
8013	Screw No. 10-32 x 1-1/8 oval hd. ....	-	4	4	4	-	-	-	-	-	-	-
224537	Foot rest to support bracket screw .....	-	2	2	2	-	-	-	-	-	-	-
206130	Foot rest support bracket cushion .....	-	2	2	2	-	-	-	-	-	-	-
206132	Foot rest support cushion .....	-	2	2	2	-	-	-	-	-	-	-

FRONT SEAT

(Straight across seat, divided back for Model 937 only)

6492	Front seat assembly to track screw 5/16-18 x 1-7/8 flat head .....	-	-	-	-	-	4	-	-	-	-	-
6126	Screw 5/16-24 x 1-7/8 flat head .....	-	-	-	-	-	2	-	-	-	-	-
307640	Washer 5/16 countersunk .....	-	-	-	-	-	2	-	-	-	-	-
6070	Lockwasher 5/16 Shakeproof - Wood type	-	-	-	-	-	2	-	-	-	-	-
7005	Nut 5/16-24 .....	-	-	-	-	-	2	-	-	-	-	-
310404	Front seat back pivot screw .....	-	-	-	-	-	3	-	-	-	-	-
310405	Front seat back pivot screw nut .....	-	-	-	-	-	1	-	-	-	-	-
6614	Front seat back pivot screw spacer washer center - 7/16 .....	-	-	-	-	-	1	-	-	-	-	-
3883	Front seat back pivot screw spacer washer center - 7/16 .....	-	-	-	-	-	2	-	-	-	-	-
229822	Front seat back spring - right .....	-	-	-	-	-	1	-	-	-	-	-
229823	Front seat back spring - left .....	-	-	-	-	-	1	-	-	-	-	-
229820	Front seat back cushion spring .....	-	-	-	-	-	1	-	-	-	-	-
229849	Front seat cushion assembly .....	-	-	-	-	-	1	-	-	-	-	-
310655	Front seat operating button and link asb..	-	-	-	-	-	1	-	-	-	-	-

Piece No.	Name	No. Required									
		832 932	833 933	834 934	835 935	836 936	837 937	838 938	839 939	873 973	827 927
310427	Front seat operating button finishing plate .....	-	-	-	-	-	1	-	-	-	-
308802	Front seat operating button finishing plate screw No. 6 x 3/8" binding hd. ....	-	-	-	-	-	1	-	-	-	-
310259	Front seat operating button retainer .....	-	-	-	-	-	1	-	-	-	-
5984	Screw No. 6 x 3/8" rnd. hd. Parker Kalon type A .....	-	-	-	-	-	4	-	-	-	-
310738	Front seat support operating mechanism right .....	-	-	-	-	-	1	-	-	-	-
310423	Front seat support operating mechanism left .....	-	-	-	-	-	1	-	-	-	-
310424	Front seat support operating mechanism connecting link .....	-	-	-	-	-	1	-	-	-	-
4302	Pin 1/8 x 1/2 spring cotter .....	-	-	-	-	-	2	-	-	-	-
5903	Front seat support operating mechanism screw 5/16-24 x 1-1/2 hex. hd. ....	-	-	-	-	-	2	-	-	-	-
5483	Front seat support operating mechanism screw 5/16-24 x 3/4 hex. hd. ....	-	-	-	-	-	2	-	-	-	-
5504	Lock washer 5/16" .....	-	-	-	-	-	4	-	-	-	-

## FRONT SEAT

122611	Front seat back compartment lid hinge ....	-	-	-	-	-	3	-	-	-
227900	Front seat back compartment lid hinge ....	-	-	-	-	-	-	-	3	-
227899	Front seat back compartment lid lock .....	-	-	-	-	-	-	-	1	-
220878	Front seat back compartment lid lock knob (cylinder locking type) .....	-	-	-	-	-	1	-	-	-
226361	Washer 3/4 plain special .....	-	-	-	-	-	1	-	-	-
220879	Nut 3/4-28 special .....	-	-	-	-	-	1	-	-	-
226722	Front seat back compartment lid lock striker plate .....	-	-	-	-	-	1	-	-	-
224750	Front seat back spring (Use with bucket seat) .....	-	-	-	-	-	2	-	-	-
220979	Front seat back spring .....	-	-	-	1	-	-	-	-	-
226037	Front seat back spring .....	1	-	-	-	-	-	-	-	-
224132	Front seat (right) back spring .....	-	1	1	-	1	-	1	-	-
229413	Front seat (right) back spring .....	-	-	-	-	-	-	1	-	-
224133	Front seat (left) back spring .....	-	1	1	-	1	-	1	1	-
181695	Front seat (right) counterbalance assembly (Use with bucket seat) .....	-	-	-	-	-	1	-	-	1
6468	Screw 1/4-28 x 5/8 oval head (Use with bucket seat) .....	-	-	-	-	-	4	-	-	4
6469	Screw 1/4-28 x 3/4 oval hd. (Use with bucket seat) .....	-	-	-	-	-	4	-	-	4
5502	Lockwasher 1/4" (Use with bucket seat) .....	-	-	-	-	-	4	-	-	4
7004	Nut 1/4-28 (Use with bucket seat) ....	-	-	-	-	-	4	-	-	4
181703	Front seat (right) counterbalance spring left (Use with bucket seat) .....	-	-	-	-	-	1	-	-	1
181702	Front seat (right) counterbalance spring right (Use with bucket seat) .....	-	-	-	-	-	1	-	-	1
181389	Front seat (right) counterbalance spring adjusting lever (Use with bucket seat) .	-	-	-	-	-	2	-	-	-
5822	Screw 1/4-28 x 5/8 hex. hd. (Use with bucket seat) .....	-	-	-	-	-	2	-	-	-
5502	Lockwasher 1/4 (Use with bucket seat) ..	-	-	-	-	-	2	-	-	-
7004	Nut 1/4-28 (Use with bucket seat) ....	-	-	-	-	-	2	-	-	-
181637	Front seat (right) counterbalance spring lever and pin assembly (Use with bucket seat) .....	-	-	-	-	-	1	-	-	1



SERVICE PARTS LIST—PACKARD TWELVE

Front Seat 391

Piece No	Name	No. Required									
		832 952	835 935	834 914	835 935	836 936	837 937	838 938	839 939	873 973	827 927
NOTE: Always send samples of material when ordering cushion assemblies, as the assemblies are upholstered to match the body interior.											
226753	Front seat cushion assembly .....	-	-	-	1	-	-	-	-	-	-
226752	Front seat cushion assembly .....	1	-	-	-	-	-	-	-	-	-
224636	Front seat (left) cushion assembly .....	-	1	1	-	1	-	1	-	-	-
229171	Front seat (left) cushion assembly .....	-	-	-	-	-	-	-	1	-	-
224755	Front seat (left) cushion assembly (Use with bucket seat) .....	-	-	-	-	-	1	-	-	-	-
224638	Front seat (right) cushion assembly .....	-	1	1	-	1	-	1	-	-	-
224754	Front seat (right) cushion assembly (Use with bucket seat) .....	-	-	-	-	-	1	-	-	-	-
228170	Front seat (right) cushion assembly .....	-	-	-	-	-	-	-	1	-	-
220977	Front seat cushion spring .....	1	-	-	1	-	-	-	-	-	-
224130	Front seat (right) cushion spring .....	-	1	1	-	1	-	1	-	-	-
214730	Front seat (right) cushion spring (Use with bucket seat) .....	-	-	-	-	-	1	-	-	-	-
214729	Front seat (left) cushion spring (Use with bucket seat) .....	-	-	-	-	-	1	-	-	-	-
228061	Front seat (right) cushion spring .....	-	-	-	-	-	-	-	1	-	-
228154	Front seat (left) cushion spring .....	-	-	-	-	-	-	-	1	-	-
224131	Front seat (left) cushion spring .....	-	1	1	-	1	-	1	-	-	-
173149	Front seat hinge .....	-	-	-	-	-	-	-	2	-	-
7612	Bolt 1/4-28 x 3/4 carriage .....	-	-	-	-	-	-	-	8	-	-
5502	Lockwasher 1/4 .....	-	-	-	-	-	-	-	8	-	-
7004	Nut 1/4-28 .....	-	-	-	-	-	-	-	8	-	-
181686	Front seat (left) lever ratchet .....	-	-	-	-	-	-	-	1	-	-
173150	Front seat (left) locking lever .....	-	-	-	-	-	-	-	1	-	-
173513	Front seat (left) locking lever pin .....	-	-	-	-	-	-	-	1	-	-
173313	Front seat (left) locking lever spring (Use with bucket seat) .....	-	-	-	-	-	1	-	-	-	-
224303	Front seat (left) operating button rod and cable assembly .....	-	1	1	-	1	-	1	-	-	-
226787	Front seat (left) operating button rod and cable assembly .....	-	-	-	-	-	-	-	1	-	-
227631	Front seat (left) operating button rod and cable assembly .....	-	-	-	-	-	-	-	-	1	-
7901	Screw No. 10-32 x 5/8 round hd. ....	-	1	1	-	1	-	1	1	-	-
220797	Front seat (left) operating button finishing plate .....	-	1	1	-	1	-	1	1	1	-
226527	Front seat (left) operating button spring .....	-	1	1	-	1	-	1	1	1	-
224302	Front seat (left) operating cable guide assembly .....	-	1	1	-	1	-	1	1	1	-
212848	Front seat (left) support operating mechanism right .....	-	1	1	-	1	-	1	1	1	-
212849	Front seat (left) support operating mechanism left .....	-	1	1	-	1	-	1	1	1	-
227697	Front seat support operating mechanism right .....	-	-	-	-	-	-	-	-	-	1
227696	Front seat support operating mechanism left .....	-	-	-	-	-	-	-	-	-	1
5566	Screw 5/16-24 x 1-1/8 hex. hd. ....	-	2	2	-	2	-	2	2	2	-
5909	Screw 5/16-24 x 1-1/2 hex. hd. ....	-	2	2	-	2	-	2	2	2	-
6177	Screw 5/16-24 x 1-5/8 hex. hd. ....	-	-	-	-	-	-	2	2	-	-
7816	Screw 5/16-24 x 2-1/2 hex. hd. ....	-	-	-	-	-	-	1	-	-	-
3909	Lockwasher 5/16 .....	-	2	2	-	2	-	2	2	2	-
7005	Nut 5/16-24 .....	-	2	2	-	2	-	2	2	2	-
5504	Lockwasher 5/16" .....	-	4	4	-	4	-	4	4	4	-

Piece No.	Name	No. Required									
		832 932	833 933	834 934	835 935	836 936	837 937	838 938	839 939	873 973	827 927
<b>GOLF COMPARTMENT</b>											
224984	Golf compartment door trimmed assembly right .....	-	-	-	-	-	-	1	-	-	-
228184	Golf compartment door trimmed assembly right .....	-	-	-	-	-	-	-	1	-	-
224985	Golf compartment door trimmed assembly left .....	-	-	-	-	-	-	1	-	-	-
228185	Golf compartment door trimmed assembly left .....	-	-	-	-	-	-	-	-	-	-
224713	Golf compartment door hinge assembly .....	-	-	-	-	-	-	4	4	-	-
224704	Golf compartment door hinge seal .....	-	-	-	-	-	-	4	4	-	-
163767	Golf compartment door lock .....	-	-	-	-	-	-	2	2	-	-
143615	Golf compartment door lock striker .....	-	-	-	-	-	-	2	2	-	-
228145	Golf compartment door weatherstrip .....	-	-	-	-	-	-	-	2	-	-
224705	Golf compartment door weatherstrip .....	-	-	-	-	-	-	2	-	-	-

### HASSOCK

135807	Hassock (Specify set numbers) .....	2	-	-	-	2	-	-	-	-	-
--------	-------------------------------------	---	---	---	---	---	---	---	---	---	---

### MOULDING

227692	Moulding door window finishing right .....	-	-	-	-	-	-	-	1	-	1
227693	Moulding door window finishing left .....	-	-	-	-	-	-	-	1	-	1
218522	Woodscrew ferrule No. 6 .....	-	-	-	-	-	-	-	10	-	10
224577	Moulding-front door-window finishing right	1	1	1	1	-	1	-	-	-	-
224578	Moulding-front door-window finishing left.	1	1	1	1	-	1	-	-	-	-
224587	Moulding-front door-window finishing right	-	-	-	-	1	-	-	-	-	-
226311	Moulding-front door-window finishing right	-	-	-	-	-	-	1	-	-	-
227716	Moulding-front door-window finishing right	-	-	-	-	-	-	-	-	1	-
227717	Moulding-front door-window finishing left.	-	-	-	-	-	-	-	-	1	-
224588	Moulding-front door-window finishing left.	-	-	-	-	1	-	-	-	-	-
226312	Moulding-front door-window finishing left.	-	-	-	-	-	-	1	-	-	-
224521	Moulding partition window finishing .....	-	-	-	1	-	-	-	-	-	-
224570	Moulding-rear door-window finishing right.	-	-	1	1	1	-	-	-	-	-
226069	Moulding-rear door-window finishing right.	1	1	-	-	-	-	-	-	-	-
224948	Moulding-rain gutter-right (86" long) ....	1	-	-	-	-	-	-	-	-	-
228329	Moulding-rain gutter-left (86" long) .....	1	-	-	-	-	-	-	-	-	-
227732	Moulding-rear door-window finishing right.	-	-	-	-	-	-	-	-	1	-
227733	Moulding-rear door-window finishing left .	-	-	-	-	-	-	-	-	1	-
224569	Moulding-rear door-window finishing left .	-	-	1	1	1	-	-	-	-	-
226070	Moulding-rear door-window finishing left .	1	1	-	-	-	-	-	-	-	-
226240	Moulding-rear-window finishing .....	-	-	-	-	-	-	1	-	-	-
224531	Moulding-rear-window finishing .....	-	1	1	1	1	1	-	-	-	-
226092	Moulding-rear-window finishing .....	1	-	-	-	-	-	-	-	-	-
226002	Moulding-roof joint (60" long) .....	1	-	-	-	-	-	-	-	-	-
226005	Moulding-roof joint (91-1/2" long) .....	-	-	-	-	2	-	-	-	-	-
226003	Moulding-roof joint (59-1/2" long) .....	-	-	-	-	-	-	2	-	-	-
226004	Moulding-roof joint (82" long) .....	-	-	-	-	-	-	2	-	-	-
220883	Moulding-roof joint (105-1/2" long) .....	-	-	2	2	-	-	-	-	-	-
226006	Moulding-roof joint (100-1/2" long) .....	-	2	-	-	-	-	-	-	-	-
224579	Moulding-side-window finishing right .....	-	1	-	-	-	-	-	-	-	-
224710	Moulding-side-window finishing right .....	-	-	-	-	-	1	-	-	-	-
224575	Moulding-side-window finishing right .....	-	-	1	1	-	-	-	-	-	-
224580	Moulding-side-window finishing left .....	-	1	-	-	-	-	-	-	-	-
224711	Moulding-side-window finishing left .....	-	-	-	-	-	1	-	-	-	-
224576	Moulding-side-window finishing left .....	-	-	1	1	-	-	-	-	-	-

Piece No.	Name	No. Required									
		812 932	833 933	834 934	835 935	836 936	837 937	838 938	839 939	873 973	827 927
224565	Moulding windshield opening finishing ....	1	1	1	1	1	1	1	-	-	-
8028	Screw No. 6-40 x 1 oval hd. ....	4	4	4	4	4	4	4	-	-	-
229447	Moulding windshield opening finishing lower .....	-	-	-	-	-	-	-	1	1	1
229448	Moulding windshield opening finishing upper .....	-	-	-	-	-	-	-	1	1	1
227917	Screw No. 10-32 x 1-3/8 oval hd. special No. 8 hd. ....	-	-	-	-	-	-	-	5	5	5
229450	Moulding windshield opening finishing side right .....	-	-	-	-	-	-	-	1	1	1
229449	Moulding windshield opening finishing side left .....	-	-	-	-	-	-	-	1	1	1
227918	Screw No. 10-32 x 1-1/8 oval hd. special No. 8 head .....	-	-	-	-	-	-	-	4	4	4

PANEL

227484	Panel cowl and dash assembly .....	-	-	-	-	-	-	-	1	-	-
220534	Panel door front right .....	-	-	-	-	1	-	-	-	-	-
220535	Panel door front left .....	-	-	-	-	1	-	-	-	-	-
220536	Panel door front right .....	1	1	1	1	-	-	-	-	-	-
224844	Panel door front right .....	-	-	-	-	-	1	-	-	-	-
224846	Panel door front right .....	-	-	-	-	-	-	1	-	-	-
220537	Panel door front left .....	1	1	1	1	-	-	-	-	-	-
224845	Panel door front left .....	-	-	-	-	-	1	-	-	-	-
224847	Panel door front left .....	-	-	-	-	-	-	1	-	-	-
224848	Panel door rear right .....	1	-	-	-	-	-	-	-	-	-
224850	Panel door rear right .....	-	1	-	-	-	-	-	-	-	-
224849	Panel door rear left .....	1	-	-	-	-	-	-	-	-	-
224851	Panel door rear left .....	-	1	-	-	-	-	-	-	-	-
220556	Panel door rear right .....	-	-	1	1	-	-	-	-	-	-
220746	Panel door rear right .....	-	-	-	-	1	-	-	-	-	-
220557	Panel door rear left .....	-	-	1	1	-	-	-	-	-	-
220747	Panel door rear left .....	-	-	-	-	1	-	-	-	-	-
224118	Panel front end assembly .....	-	1	1	1	1	1	1	-	-	-
226267	Panel front end assembly .....	1	-	-	-	-	-	-	-	-	-
228196	Panel golf compartment door right .....	-	-	-	-	-	-	-	1	-	-
224728	Panel golf compartment door right .....	-	-	-	-	-	-	-	1	-	-
224729	Panel golf compartment door left .....	-	-	-	-	-	-	-	1	-	-
228197	Panel golf compartment door left .....	-	-	-	-	-	-	-	1	-	-
224810	Panel rear deck .....	-	-	-	-	-	1	-	-	-	-
224725	Panel rear deck .....	-	-	-	-	-	-	1	-	-	-
224715	Panel rumble seat compartment door .....	-	-	-	-	-	-	1	1	-	-
228195	Panel seat and deck assembly .....	-	-	-	-	-	-	-	1	-	-
220539	Panel wheel compartment door .....	1	1	1	1	-	-	-	-	-	-
224254	Panel wheel compartment door .....	-	-	-	-	1	-	-	-	-	-
224811	Panel wheel compartment door .....	-	-	-	-	-	1	-	-	-	-

PARTITION

211539	Partition back compartment lid handle ....	1	-	-	-	-	-	-	-	-	-
122611	Partition back compartment lid hinge .....	2	-	-	-	-	-	-	-	-	-
105029	Partition back compartment lid spring dowel .....	1	-	-	-	-	-	-	-	-	-
229264	Partition back compartment lid striker plate .....	1	-	-	-	-	-	-	-	-	-
229499	Partition header clock (Supersedes 226284)	-	-	-	1	-	-	-	-	-	-
224991	Partition header glass stop .....	2	-	-	-	-	-	-	-	-	-

Piece No.	Name	No. Required									
		832 932	833 933	834 934	835 935	836 936	837 937	838 938	839 939	873 973	827 927
226789	Partition header liner .....	1	-	-	-	-	-	-	-	-	-
228051	Partition regulator handle compartment lid trimmed assembly .....	1	-	-	-	-	-	-	-	-	-
226338	Partition regulator handle compartment lid hinge .....	1	-	-	-	-	-	-	-	-	-
6193	Rivet 1/8 x 3/16 countersunk hd. ....	6	-	-	-	-	-	-	-	-	-
229261	Partition regulator handle compartment lid knob .....	1	-	-	-	-	-	-	-	-	-
5497	Machine screw No. 10-32 x 1/2 oval hd.	1	-	-	-	-	-	-	-	-	-
164239	Ferrule No. 10 .....	1	-	-	-	-	-	-	-	-	-
226025	Partition regulator handle compartment lid striker plate .....	2	-	-	-	-	-	-	-	-	-
105029	Partition regulator handle compartment lid dowel .....	2	-	-	-	-	-	-	-	-	-

REAR SEAT

220817	Rear seat back spring right .....	1	1	1	1	-	-	-	-	-	-
224489	Rear seat back spring right .....	-	-	-	-	1	-	-	-	-	-
224789	Rear seat back spring right .....	-	-	-	-	-	1	-	-	-	-
220818	Rear seat back spring left .....	1	1	1	1	-	-	-	-	-	-
224490	Rear seat back spring left .....	-	-	-	-	1	-	-	-	-	-
224790	Rear seat back spring left .....	-	-	-	-	-	1	-	-	-	-
220816	Rear seat cushion assembly (Specify set numbers) .....	1	1	1	1	-	-	-	-	-	-
224763	Rear seat cushion assembly (Specify set number) .....	-	-	-	-	1	-	-	-	-	-
226282	Rear seat cushion assembly (Specify set number) .....	-	-	-	-	-	1	-	-	-	-
220814	Rear seat cushion spring .....	1	1	1	1	-	-	-	-	-	-
224488	Rear seat cushion spring .....	-	-	-	-	1	-	-	-	-	-
224794	Rear seat cushion spring .....	-	-	-	-	-	1	-	-	-	-
212602	Rear seat folding arm rest cushion .....	1	1	1	1	1	1	-	-	-	-
224918	Rear seat folding arm rest cushion spacer.	-	-	-	-	-	1	-	-	-	-
224075	Rear seat folding arm rest panel assembly.	1	1	1	1	1	-	-	-	-	-
224819	Rear seat folding arm rest panel assembly.	-	-	-	-	-	1	-	-	-	-
224082	Screw .....	4	4	4	4	4	4	-	-	-	-
62065	Washer 1/4 .....	4	4	4	4	4	4	-	-	-	-
5502	Lockwasher 1/4" .....	4	4	4	4	4	4	-	-	-	-
211648	Nut 1/4-28 .....	4	4	4	4	4	4	-	-	-	-
211809	Spring washer .....	4	4	4	4	4	4	-	-	-	-
224082	Rear seat folding arm rest pivot screw ...	4	4	4	4	4	4	-	-	-	-
62065	Washer 1/4" .....	4	4	4	4	4	4	-	-	-	-
5502	Lockwasher 1/4" .....	4	4	4	4	4	4	-	-	-	-
E11648	Nut 1/4-28 .....	4	4	4	4	4	4	-	-	-	-
211809	Spring washer .....	4	4	4	4	4	4	-	-	-	-
220820	Rear seat folding arm rest spring .....	1	1	1	1	1	-	-	-	-	-
224793	Rear seat folding arm rest spring .....	-	-	-	-	-	1	-	-	-	-

REAR VIEW MIRROR

224246	Rear view mirror complete .....	1	1	1	1	1	1	1	1	1	1
224332	Screw No. 8-32 x 5/16" round hd. ....	2	2	2	2	2	2	2	2	2	2
226331	Screw No. 8-32 x 1-1/4" oval hd. (Shakeproof) .....	2	2	2	2	2	2	2	2	2	2
226330	Screw No. 8-32 x 3/8" oval hd. (Shakeproof) .....	-	-	-	-	-	-	-	3	3	3
224331	Rear view mirror bracket assembly .....	1	1	1	1	1	1	1	1	1	1

Piece No.	Name	No. Required									
		832 932	833 933	834 934	835 935	836 936	837 937	838 938	839 939	873 973	827 927
<b>ROBE RAIL</b>											
227807	Robe rail assembly .....	-	-	-	-	-	-	-	-	1	-
224530	Robe rail assembly (Specify set number) ..	1	1	1	1	1	-	-	-	-	-
206709	Robe rail attaching plate .....	2	2	2	2	2	-	-	-	-	-
206710	Robe rail attaching plate spring .....	2	2	2	2	2	-	-	-	-	-

**RUMBLE SEAT**

226335	Rumble seat back spring .....	-	-	-	-	-	-	1	1	-	-
157018	Rumble seat compartment door bumper .....	-	-	-	-	-	-	2	2	-	-
224718	Rumble seat compartment door hinge right .	-	-	-	-	-	-	1	1	-	-
224719	Rumble seat compartment door hinge left ..	-	-	-	-	-	-	1	1	-	-
5909	Screw 5/16-24 x 1-1/2" hex. hd. ....	-	-	-	-	-	-	4	4	-	-
5504	Lockwasher 5/16" .....	-	-	-	-	-	-	6	6	-	-
7005	Nut 5/16-24 .....	-	-	-	-	-	-	2	2	-	-
6305	Stud 5/16" .....	-	-	-	-	-	-	2	2	-	-
224716	Rumble seat compartment door hinge bracket right .....	-	-	-	-	-	-	1	1	-	-
224717	Rumble seat compartment door hinge bracket left .....	-	-	-	-	-	-	1	1	-	-
7613	Rumble seat compartment door hinge bracket bolt 1/4-28 x 1-3/4" carriage .....	-	-	-	-	-	-	4	4	-	-
7004	Nut 1/4-28 .....	-	-	-	-	-	-	4	4	-	-
5502	Lockwasher 1/4" .....	-	-	-	-	-	-	4	4	-	-
8222	Rumble seat compartment door hinge bracket screw 3/8-24 x 1" flat hd. ....	-	-	-	-	-	-	4	4	-	-
7006	Nut 3/8-24 .....	-	-	-	-	-	-	4	4	-	-
5506	Lockwasher 3/8" .....	-	-	-	-	-	-	4	4	-	-
127501	Rumble seat compartment door hinge bushing	-	-	-	-	-	-	2	2	-	-
127498	Rumble seat compartment door hinge screw .	-	-	-	-	-	-	2	2	-	-
3884	washer 1/2" .....	-	-	-	-	-	-	2	2	-	-
5510	Lockwasher 1/2" .....	-	-	-	-	-	-	2	2	-	-
157584	Rumble seat compartment door operating bolt .....	-	-	-	-	-	-	2	2	-	-
7104	Nut 1/4-28 castle .....	-	-	-	-	-	-	2	2	-	-
4280	Cotter pin 1/16 x 1/2" .....	-	-	-	-	-	-	2	2	-	-
196243	Rumble seat compartment door operating spring .....	-	-	-	-	-	-	2	2	-	-
157585	Rumble seat compartment door operating spring washer .....	-	-	-	-	-	-	2	2	-	-
224961	Rumble seat compartment drain gutter assembly .....	-	-	-	-	-	-	1	1	-	-
226341	Rumble seat cushion assembly .....	-	-	-	-	-	-	1	1	-	-
226334	Rumble seat cushion spring .....	-	-	-	-	-	-	1	1	-	-
148339	Rumble seat door lock .....	-	-	-	-	-	-	1	1	-	-
228127	Rumble seat door lock operating bell crank yoke and clip assembly front .....	-	-	-	-	-	-	-	1	-	-
228129	Rumble seat door lock operating bell crank yoke and clip assembly rear .....	-	-	-	-	-	-	-	1	-	-
223392	Rumble seat door lock operating bell crank-clip (Supersedes 228142) .....	-	-	-	-	-	-	-	4	-	-
228128	Rumble seat door lock operating bell crank-rod front .....	-	-	-	-	-	-	-	1	-	-
228130	Rumble seat door lock operating bell crank-rod rear .....	-	-	-	-	-	-	-	1	-	-
3907	Rumble seat door lock operating bell crank-rod washer 1/4" plain .....	-	-	-	-	-	-	-	4	-	-

Piece No.	Name	No. Required									
		832 932	833 933	834 934	835 935	836 936	837 937	838 938	839 939	873 973	827 927
228139	Rumble seat door lock operating knob .....	-	-	-	-	-	-	-	1	-	-
226960	Rumble seat door lock operating knob ferrule .....	-	-	-	-	-	-	-	1	-	-
226961	Rumble seat door lock operating knob ferrule clinch plate .....	-	-	-	-	-	-	-	1	-	-
228137	Rumble seat door lock operating rod-yoke and clip assembly-front .....	-	-	-	-	-	-	-	1	-	-
173411	Rumble seat door lock operating rod and yoke end assembly .....	-	-	-	-	-	-	1	-	-	-
228149	Rumble seat door lock operating rod and yoke end assembly-rear .....	-	-	-	-	-	-	-	1	-	-
228135	Rumble seat door lock operating rod and yoke end assembly-side .....	-	-	-	-	-	-	-	1	-	-
7513	Yoke end adj. 3/16" .....	-	-	-	-	-	-	1	2	-	-
7003	Nut No. 10-32 thd. ....	-	-	-	-	-	-	1	2	-	-
7523	Yoke end pin 3/16" .....	-	-	-	-	-	-	3	5	-	-
3906	Washer 3/16" .....	-	-	-	-	-	-	2	-	-	-
4690	Cotter pin 1/16 x 3/8" .....	-	-	-	-	-	-	3	5	-	-
224831	Rumble seat door lock operating lever ....	-	-	-	-	-	-	1	-	-	-
157625	Rumble seat door lock striker .....	-	-	-	-	-	-	1	1	-	-
226513	Rumble seat step upper gasket .....	-	-	-	-	-	-	1	1	-	-
226512	Rumble seat step upper mat .....	-	-	-	-	-	-	1	1	-	-
226512	Rumble seat step lower mat .....	-	-	-	-	-	-	1	1	-	-
226510	Rumble seat step upper assembly .....	-	-	-	-	-	-	1	1	-	-
5666	Stud 3/8" .....	-	-	-	-	-	-	2	2	-	-
114055	Washer .....	-	-	-	-	-	-	2	2	-	-
5506	Lockwasher 3/8" .....	-	-	-	-	-	-	2	2	-	-
7006	Nut 3/8-24 .....	-	-	-	-	-	-	2	2	-	-
226567	Rumble seat step lower assembly .....	-	-	-	-	-	-	1	1	-	-
226580	Rumble seat step lower clamp plate .....	-	-	-	-	-	-	1	1	-	-
7878	Screw 3/8-24 x 1-3/4" hex. hd. ....	-	-	-	-	-	-	2	2	-	-
5506	Lockwasher 3/8" .....	-	-	-	-	-	-	2	2	-	-
7006	Nut 3/8-24 .....	-	-	-	-	-	-	2	2	-	-

SMOKING CASE

224996	Smoking case assembly-right .....	-	-	-	-	1	-	-	-	-	-
224997	Smoking case assembly-left .....	-	-	-	-	1	-	-	-	-	-
105029	Smoking case assembly spring dowel .....	-	-	-	-	2	-	-	-	-	-
212369	Smoking case assembly spring dowel striker	-	-	-	-	2	-	-	-	-	-
226306	Smoking case ash receiver .....	-	-	-	-	2	-	-	-	-	-
224509	Smoking case cigar lighter complete .....	-	-	-	-	2	-	-	-	-	-
211191	Smoking case cigar lighter .....	-	-	-	-	2	-	-	-	-	-
182377	Smoking case cigar lighter tip .....	-	-	-	-	2	-	-	-	-	-

SUN VISOR

224744	Sun visor assembly (Specify set number) ..	2	2	2	2	2	2	2	-	-	-
224714	Sun visor hinge bracket assembly .....	2	2	2	2	2	2	2	-	-	-
228352	Screw 1/4-28 x 5/8" oval hd. special .	4	4	4	4	4	4	4	-	-	-

TOGGLE GRIP

224688	Toggle grip .....	2	2	2	2	2	2	-	-	-	-
224536	Toggle grip pivot stud .....	2	2	2	2	2	2	-	-	-	-
187483	Toggle grip pivot stud screw bushing .....	2	2	2	2	2	2	-	-	-	-
229250	Toggle grip pivot stud spring washer .....	2	2	2	2	2	2	-	-	-	-
224535	Toggle grip pivot stud washer .....	2	2	2	2	2	2	-	-	-	-

Piece No	Name	No. Required									
		832 932	833 933	834 934	835 935	836 936	837 937	838 938	839 939	871 971	827 927
<b>TONNEAU LIGHT</b>											
224559	Tonneau light .....	-	-	-	-	-	-	-	-	1	-
224597	Tonneau light glass and rim .....	-	-	-	-	-	-	-	-	1	-
183836	Tonneau light reflector .....	-	-	-	-	-	-	-	-	1	-

**TOP**

228193	Top assembly .....	-	-	-	-	-	-	-	1	-	-
230031	Top body bracket assembly .....	-	-	-	-	-	-	-	1	-	-
230055	Top body bracket right .....	-	-	-	-	-	-	-	1	-	-
230056	Top body bracket left .....	-	-	-	-	-	-	-	1	-	-
230057	Top body bracket serrated nut .....	-	-	-	-	-	-	-	2	-	-
230058	Top body bracket shoulder bolt .....	-	-	-	-	-	-	-	2	-	-
230059	Top body bracket shoulder bolt washer .....	-	-	-	-	-	-	-	2	-	-
227713	Top bow auxiliary .....	-	-	-	-	-	-	-	-	1	-
227687	Top bow auxiliary .....	-	-	-	-	-	-	-	-	-	1
227293	Top bow auxiliary to hinge plate .....	-	-	-	-	-	-	-	-	2	2
227292	Top bow auxiliary to hinge plate screw .....	-	-	-	-	-	-	-	-	2	2
230054	Top clevis handles assembly .....	-	-	-	-	-	-	-	2	-	-
229595	Top envelope assembly .....	-	-	-	-	-	-	-	1	-	-
230041	Top folding pillar bow .....	-	-	-	-	-	-	-	1	-	-
228177	Top folding pillar bumper .....	-	-	-	-	-	-	-	x	-	-
228094	Top folding pillar hinge right .....	-	-	-	-	-	-	-	1	-	-
228095	Top folding pillar hinge left .....	-	-	-	-	-	-	-	1	-	-
6236	Screw 1/4-28 x 1-7/8" flat hd. ....	-	-	-	-	-	-	-	2	-	-
228099	Top folding pillar hinge bracket right ...	-	-	-	-	-	-	-	1	-	-
228098	Top folding pillar hinge bracket left ....	-	-	-	-	-	-	-	1	-	-
6236	Screw 1/4-28 x 1-7/8" flat hd. ....	-	-	-	-	-	-	-	4	-	-
228069	Top folding pillar hinge pin .....	-	-	-	-	-	-	-	2	-	-
230032	Top header .....	-	-	-	-	-	-	-	1	-	-
230033	Top header bracket right .....	-	-	-	-	-	-	-	1	-	-
230034	Top header bracket left .....	-	-	-	-	-	-	-	1	-	-
227756	Top hold down clamp plate .....	-	-	-	-	-	-	-	-	2	-
227768	Top hold down handle and latch assembly right .....	-	-	-	-	-	-	-	-	2	-
227769	Top hold down handle and latch assembly left .....	-	-	-	-	-	-	-	-	2	-
230048	Top joint upper .....	-	-	-	-	-	-	-	2	-	-
230049	Top joint lower right .....	-	-	-	-	-	-	-	1	-	-
230050	Top joint upper left .....	-	-	-	-	-	-	-	1	-	-
227678	Top main bow hinge lower right .....	-	-	-	-	-	-	-	-	1	-
227679	Top main bow hinge lower left .....	-	-	-	-	-	-	-	-	1	-
227652	Top main bow hinge lower right .....	-	-	-	-	-	-	-	-	-	1
227653	Top main bow hinge lower left .....	-	-	-	-	-	-	-	-	-	1
227660	Top main bow hinge to body bracket screw .	-	-	-	-	-	-	-	-	2	2
227682	Top main bow hinge body bracket right ....	-	-	-	-	-	-	-	-	1	-
227648	Top main bow hinge body bracket right ....	-	-	-	-	-	-	-	-	-	1
227683	Top main bow hinge body bracket left .....	-	-	-	-	-	-	-	-	1	-
227649	Top main bow hinge body bracket left .....	-	-	-	-	-	-	-	-	-	1
227784	Top main bow slat iron to bracket screw ..	-	-	-	-	-	-	-	-	2	2
230044	Top pillar hinge right .....	-	-	-	-	-	-	-	1	-	-
230045	Top pillar hinge left .....	-	-	-	-	-	-	-	1	-	-
227644	Top prop complete right .....	-	-	-	-	-	-	-	-	-	1
227645	Top prop complete left .....	-	-	-	-	-	-	-	-	-	1
230053	Top rear bow .....	-	-	-	-	-	-	-	1	-	-

Piece No	Name	No. Required									
		832 932	833 933	834 934	835 935	836 936	837 937	838 938	839 939	873 973	827 927
230051	Top rear bow slat right .....	-	-	-	-	-	-	-	1	-	-
230052	Top rear bow slat left .....	-	-	-	-	-	-	-	1	-	-
227579	Top rear window glass .....	-	-	-	-	-	-	-	1	1	1
179131	Top rear window glass frame .....	-	-	-	-	-	-	-	1	1	1
227753	Top removable center pillar pad .....	-	-	-	-	-	-	-	-	2	-
227606	Top removable center pillar on body dove- tail right .....	-	-	-	-	-	-	-	-	1	-
227607	Top removable center pillar on body dove- tail left .....	-	-	-	-	-	-	-	-	1	-
227608	Top removable center pillar on pillar dovetail right .....	-	-	-	-	-	-	-	-	1	-
227609	Top removable center pillar on pillar dovetail left .....	-	-	-	-	-	-	-	-	1	-
227758	Top removable center pillar top lock plate right .....	-	-	-	-	-	-	-	-	1	-
227759	Top removable center pillar top lock plate left .....	-	-	-	-	-	-	-	-	1	-
230035	Top side rail slat iron front .....	-	-	-	-	-	-	-	2	-	-
230036	Top side rail lock plate right .....	-	-	-	-	-	-	-	1	-	-
230037	Top side rail lock plate left .....	-	-	-	-	-	-	-	1	-	-
230038	Top side rail lock plate knob .....	-	-	-	-	-	-	-	2	-	-
230039	Top side rail hinge assembly .....	-	-	-	-	-	-	-	2	-	-
230040	Top side rail slat iron rear .....	-	-	-	-	-	-	-	2	-	-
227765	Top side roof rail bumper center .....	-	-	-	-	-	-	-	-	2	-
227368	Top side roof rail locking dowel plate right .....	-	-	-	-	-	-	-	-	1	-
227369	Top side roof rail locking dowel plate left .....	-	-	-	-	-	-	-	-	1	-
230046	Top shoulder bolt roof rail rear .....	-	-	-	-	-	-	-	2	-	-
227742	Top slat iron assembly right .....	-	-	-	-	-	-	-	-	1	-
227688	Top slat iron assembly right .....	-	-	-	-	-	-	-	-	-	1
227743	Top slat iron assembly left .....	-	-	-	-	-	-	-	-	1	-
227689	Top slat iron assembly left .....	-	-	-	-	-	-	-	-	-	1
230047	Top sleeve nut pillar bracket .....	-	-	-	-	-	-	-	2	-	-
230042	Top upper pillar bracket right .....	-	-	-	-	-	-	-	1	-	-
230043	Top upper pillar bracket left .....	-	-	-	-	-	-	-	1	-	-
227646	Top to windshield clamp assembly .....	-	-	-	-	-	-	-	2	2	2
5587	Screw No. 10-32 x 3/8" oval hd. ....	-	-	-	-	-	-	-	4	4	4
227621	Top to windshield header bumper .....	-	-	-	-	-	-	-	3	3	3
229262	Top to windshield header weatherstrip ....	-	-	-	-	-	-	-	1	-	-

## TRUNK

212280	Trunk key lock .....	-	-	-	-	1	-	-	-	-	-
228046	Trunk key lock catch .....	-	-	-	-	1	-	-	-	-	-
226048	Trunk lid assembly .....	-	-	-	-	1	-	-	-	-	-
229299	Trunk lid clamp (Supersedes 212298) .....	-	-	-	-	2	-	-	-	-	-
8013	Screw No. 8-32 x 7/16" oval hd. ....	-	-	-	-	4	-	-	-	-	-
5254	Screw No. 8-32 x 5/16" oval hd. ....	-	-	-	-	4	-	-	-	-	-
5860	Lockwasher No. 8 countersunk (Shakeproof) .....	-	-	-	-	4	-	-	-	-	-
184249	Trunk lid clamp screw ferrule No. 8 .....	-	-	-	-	4	-	-	-	-	-
224700	Trunk lid clamp bracket .....	-	-	-	-	2	-	-	-	-	-
218525	Screw No. 8-32 x 3/4" oval hd. ....	-	-	-	-	4	-	-	-	-	-
5254	Screw No. 8-32 x 5/16" oval hd. ....	-	-	-	-	4	-	-	-	-	-
5860	Lockwasher No. 8 countersunk (Shakeproof) .....	-	-	-	-	4	-	-	-	-	-
184249	Trunk lid clamp bracket screw ferrule No. 8 .....	-	-	-	-	4	-	-	-	-	-



Piece No.	Name	No. Required									
		832 932	833 933	834 934	835 935	836 936	837 937	838 938	839 939	873 973	827 927
212436	Trunk lid clamp bracket liner .....	-	-	-	-	2	-	-	-	-	-
229329	Trunk lid clamp bracket reinforcement ....	-	-	-	-	1	-	-	-	-	-
212435	Trunk lid clamp liner .....	-	-	-	-	2	-	-	-	-	-
224692	Trunk lid hinge right .....	-	-	-	-	1	-	-	-	-	-
224691	Trunk lid hinge left .....	-	-	-	-	1	-	-	-	-	-
7842	Screw 1/4-28 x 1-1/4" hex. hd. ....	-	-	-	-	4	-	-	-	-	-
5502	Lockwasher 1/4" .....	-	-	-	-	4	-	-	-	-	-
212304	Screw 1/4-28 x 9/16" special hd. ....	-	-	-	-	8	-	-	-	-	-
7004	Nut 1/4-28 .....	-	-	-	-	8	-	-	-	-	-
5502	Lockwasher 1/4" .....	-	-	-	-	8	-	-	-	-	-
226700	Trunk lid hinge shim .....	-	-	-	-	x	-	-	-	-	-
226786	Trunk lid hinge spring .....	-	-	-	-	4	-	-	-	-	-
226730	Trunk lid weatherstrip .....	-	-	-	-	1	-	-	-	-	-

VENTILATOR

220711	Ventilator cover assembly .....	1	1	1	1	1	1	1	1	1	1
5569	Ventilator cover attaching screw										
	No. 10-32 x 1/2" fillister hd. ....	4	4	4	4	4	4	4	4	4	4
3866	Washer 3/16" .....	4	4	4	4	4	4	4	4	4	4
5500	Lockwasher 3/16" .....	4	4	4	4	4	4	4	4	4	4
7003	Nut No. 10-32 .....	4	4	4	4	4	4	4	4	4	4
220718	Ventilator cover operating lever and roller assembly .....	1	1	1	1	1	1	1	1	1	1
145661	Screw No. 10-32 .....	1	1	1	1	1	1	1	1	1	1
5739	Screw No. 10 (.190)-32 x 1/2" hex. hd.	1	1	1	1	1	1	1	1	1	1
5500	Lockwasher 3/16" .....	2	2	2	2	2	2	2	2	2	2
220723	Ventilator cover operating lever ratchet assembly .....	1	1	1	1	1	1	1	1	1	1
5569	Screw No. 10-32 x 1/2" fill. hd. ....	2	2	2	2	2	2	2	2	2	2
5500	Lockwasher 3/16" .....	2	2	2	2	2	2	2	2	2	2
7003	Nut No. 10-32 .....	2	2	2	2	2	2	2	2	2	2
220719	Ventilator cover operating lever ratchet bracket .....	2	2	2	2	2	2	2	2	2	2
220735	Ventilator cover operating lever ratchet yoke end pin 5/16" .....	1	1	1	1	1	1	1	1	1	1
4280	Cotter pin 1/16 x 1/2" spring .....	1	1	1	1	1	1	1	1	-	-
199374	Ventilator cover spring .....	1	1	1	1	1	1	1	1	1	1
220717	Ventilator drain gutter assembly .....	1	1	1	1	1	1	1	-	-	-
102507	Ventilator drain tube grommet .....	1	1	1	1	1	1	1	1	1	1
220734	Ventilator drain tube hose .....	2	2	2	2	2	2	2	2	2	2
5253	Ventilator drain tube hose clamp screw										
	No. 10-32 x 3/4" round hd. ....	2	2	2	2	2	2	2	2	2	2
5500	Lockwasher No. 10 .....	2	2	2	2	2	2	2	2	2	2
7003	Nut No. 10-32 .....	2	2	2	2	2	2	2	2	2	2
220726	Ventilator weatherstrip .....	1	1	1	1	1	1	1	1	1	1

WHEEL COMPARTMENT

228189	Wheel compartment bottom tire stop (Not used with side wheel carrier for 836) ..	-	-	-	-	2	2	-	-	-	-
7842	Screw 1/4-28 x 1-1/4" hex. hd. ....	-	-	-	-	4	4	-	-	-	-
5502	Lockwasher 1/4" (Not used with side wheel carrier for 836) .....	-	-	-	-	4	4	-	-	-	-
62065	Washer 1/4" plain (Not used with side wheel carrier for 836) .....	-	-	-	-	4	4	-	-	-	-
224183	Wheel compartment door brace assembly ....	1	1	1	1	-	-	-	-	1	-
224835	Wheel compartment door brace assembly ....	-	-	-	-	1	-	-	-	-	-

Piece No	Name	No. Required									
		832 932	833 933	834 934	835 935	836 936	837 937	838 938	839 939	873 973	827 927
224973	Wheel compartment door brace assembly left	-	-	-	-	-	1	-	-	-	1
228121	Wheel compartment door brace assembly right .....	-	-	-	-	-	1	-	-	-	1
5747	Screw 1/4-28 x 1-5/8" flat hd. ....	-	-	-	-	-	2	-	-	-	2
5676	Screw No. 10-32 x 3/8" round hd. ....	-	-	-	-	-	2	-	-	-	2
62065	Washer 1/4" plain .....	-	-	-	-	-	2	-	-	-	2
5500	Lockwasher 3/16" .....	-	-	-	-	-	2	-	-	-	2
7003	Nut No. 10-32 .....	-	-	-	-	-	2	-	-	-	2
5502	Lockwasher 1/4" .....	-	-	-	-	-	2	-	-	-	2
7004	Nut 1/4-28 .....	-	-	-	-	-	2	-	-	-	2
224838	Wheel compartment door brace stop .....	-	-	-	-	1	-	-	-	-	-
111687	Wheel compartment door bumper .....	-	-	-	-	-	2	-	-	-	2
224840	Wheel compartment door drain gutter asb. .	-	-	-	-	-	1	-	-	-	-
220780	Wheel compartment door hinge assembly ....	2	2	2	2	-	-	-	-	2	-
226065	Wheel compartment door hinge assembly right .....	-	-	-	-	-	1	-	-	-	1
226066	Wheel compartment door hinge assembly left	-	-	-	-	-	1	-	-	-	1
224601	Wheel compartment door hinge assembly ....	-	-	-	-	2	-	-	-	-	-
5827	Screw 1/4-28 x 1" flat hd. ....	6	6	6	6	-	-	-	-	6	-
226289	Screw 1/4-28 x 1-11/32" hex. hd. ....	-	-	-	-	2	-	-	-	2	-
5854	Screw 1/4-28 x 1-1/4" flat hd. ....	-	-	-	-	4	-	-	-	-	-
8221	Screw 1/4-28 x 1-5/16" flat hd. ....	-	-	-	-	-	8	-	-	-	8
8220	Screw 1/4-28 x 1-1/2" flat hd. ....	4	4	4	4	-	-	-	-	4	-
5502	Lockwasher 1/4" .....	-	-	-	-	2	-	-	-	-	-
176282	Wheel compartment door lock .....	1	1	1	1	-	1	-	-	1	1
220513	Wheel compartment door lock (Used on 836).	-	-	-	-	1	-	-	-	-	-
229819	Wheel compartment door lock (Used on 936).	-	-	-	-	1	-	-	-	-	-
220960	Wheel compartment door lock handle (with key lock) .....	1	1	1	1	-	-	-	-	1	-
224828	Wheel compartment door lock handle (with key lock) .....	-	-	-	-	-	1	-	-	-	1
220961	Wheel compartment door lock handle attaching plate (locking handle) .....	1	1	1	1	-	-	-	-	1	-
206188	Wheel compartment door lock handle attaching plate (locking handle) .....	-	-	-	-	-	1	-	-	-	-
220962	Wheel compartment door lock handle escutcheon plate .....	1	1	1	1	-	-	-	-	1	-
224905	Wheel compartment door lock handle escutcheon plate .....	-	-	-	-	-	1	-	-	-	1
220963	Wheel compartment door lock handle screw .	1	1	1	1	-	1	-	-	1	1
185236	Wheel compartment door lock handle screw washer .....	1	1	1	1	-	1	-	-	1	1
220784	Wheel compartment door lock striker .....	1	1	1	1	-	-	-	-	1	-
224910	Wheel compartment door lock striker .....	-	-	-	-	-	1	-	-	-	1
224909	Wheel compartment door lock striker .....	-	-	-	-	1	-	-	-	-	-
228125	Wheel compartment door lock striker shim .	x	x	x	x	-	-	-	-	x	-
62065	Washer 1/4" plain .....	x	x	x	x	-	-	-	-	x	-
229328	Wheel compartment door weatherstrip .....	x	x	x	x	-	-	-	-	x	-
226269	Wheel compartment door weatherstrip long .	-	-	-	-	-	1	-	-	-	-
226286	Wheel compartment door weatherstrip short.	-	-	-	-	-	1	-	-	-	-
226586	Wheel compartment gasoline tank filler housing grommet .....	1	1	1	1	-	-	-	-	-	-
136593	Wheel compartment light switch .....	-	-	-	-	-	-	-	-	1	1
228323	Wheel compartment gasoline tank inlet shield .....	-	-	-	-	1	1	-	-	1	1
167261	Screw No. 10 x 3/8" Parker Kalon .....	-	-	-	-	4	4	-	-	4	4
226701	Wheel compartment tire well cover assembly (Use with side wheel carrier only) .....	1	1	1	1	-	-	-	-	-	-
226587	Wheel compartment tire well cover clamp (Use with side wheel carrier only) .....	2	2	2	2	-	-	-	-	-	-

Piece No.	Name	No. Required									
		832 932	833 933	834 934	835 935	836 936	837 937	838 938	839 939	873 973	827 927
196663	Wheel compartment tire well cover clamp screw No. 10 x 3/8 Parker Kalon) "Z" type - (Use with side wheel carrier only) .....	2	2	2	2	-	-	-	-	-	-

WINDOW CURTAIN

228312	Window curtain rear assembly .....	-	1	1	1	1	1	1	-	-	-
228314	Window curtain rear assembly .....	1	-	-	-	-	-	-	-	-	-
224071	Window curtain rear and housing assembly (concealed type) .....	-	1	1	1	1	1	1	-	-	-
226379	Window curtain rear and housing assembly (concealed type) .....	1	-	-	-	-	-	-	-	-	-
226309	Window curtain rear finger pull .....	1	1	1	1	1	1	1	-	-	-
224458	Window curtain side right assembly .....	-	1	-	-	-	-	-	-	-	-
224459	Window curtain side left assembly .....	-	1	-	-	-	-	-	-	-	-
226574	Window curtain side right assembly .....	-	-	-	-	-	1	-	-	-	-
224462	Window curtain side right assembly .....	-	-	1	1	-	-	-	-	-	-
224463	Window curtain side left assembly .....	-	-	1	1	-	-	-	-	-	-
226575	Window curtain side left assembly .....	-	-	-	-	-	1	-	-	-	-
220972	Window curtain rod rear assembly .....	-	1	1	1	1	1	1	-	-	-
226524	Window curtain rod rear assembly .....	1	-	-	-	-	-	-	-	-	-
224343	Window curtain rod side assembly .....	-	2	-	-	-	-	-	-	-	-
226526	Window curtain rod side assembly .....	-	-	-	-	-	2	-	-	-	-
224237	Window curtain rod side assembly .....	-	-	2	2	-	-	-	-	-	-
36111	Window curtain rod anti-rattler .....	-	4	4	4	-	4	-	-	-	-
214901	Window curtain rod screw eye .....	-	4	4	4	-	4	-	-	-	-
228156	Window curtain roller rear assembly .....	1	-	-	-	-	-	-	-	-	-
228155	Window curtain roller rear assembly .....	-	1	1	1	1	1	1	-	-	-
224392	Window curtain roller side right .....	-	1	-	-	-	-	-	-	-	-
226517	Window curtain roller side right .....	-	-	-	-	-	1	-	-	-	-
224411	Window curtain roller side left .....	-	1	-	-	-	-	-	-	-	-
226516	Window curtain roller side left .....	-	-	-	-	-	1	-	-	-	-
224230	Window curtain roller side right .....	-	-	1	1	-	-	-	-	-	-
224342	Window curtain roller side left .....	-	-	1	1	-	-	-	-	-	-
228158	Window curtain roller bracket female rear ..	1	1	1	1	1	1	1	-	-	-
228157	Window curtain roller bracket male rear ..	1	1	1	1	1	1	1	-	-	-
212713	Window curtain-roller bracket-male washer ..	1	3	3	3	1	3	1	-	-	-
224115	Window curtain roller bracket female side right .....	-	1	1	1	-	1	-	-	-	-
224309	Window curtain roller bracket female side left .....	-	1	1	1	-	1	-	-	-	-
224137	Window curtain roller bracket male assembly side right .....	-	1	1	1	-	-	-	-	-	-
224310	Window curtain roller bracket male assembly side left .....	-	1	1	1	-	-	-	-	-	-
170966	Window curtain tassel .....	-	2	2	2	-	2	-	-	-	-

WINDOW

220652	Window (front door front) right assembly ..	1	1	1	1	1	1	1	-	-	-
227702	Window (front door front) right assembly ..	-	-	-	-	-	-	-	1	1	1
220653	Window (front door front) left assembly ..	1	1	1	1	1	1	1	-	-	-
227703	Window (front door front) left assembly ..	-	-	-	-	-	-	-	1	1	1
6448	Window (front door front) assembly screw 1/4-20 x 3/8" hex. hd. ....	4	4	4	4	4	4	4	-	-	-
5447	Lockwasher 1/4" (Shakeproof) .....	4	4	4	4	4	4	4	-	-	-
220620	Window (front door front) glass .....	2	2	2	2	2	2	2	-	-	-

Piece No.	Name	No. Required										
		832 932	833 933	834 934	835 935	836 936	837 937	838 938	839 939	873 973	827 927	
227701	Window (front door front) glass .....	-	-	-	-	-	-	-	-	2	2	2
211649	Window (front door front) glass cushion 3/32 thick .....	x	x	x	x	x	x	x	x	-	-	-
228272	Window (front door front) glass cushion 1/16 thick .....	x	x	x	x	x	x	x	x	-	-	-
229324	Window (front door front) glass cushion (.080 x 1-1/2 everseal) .....	x	x	x	x	x	x	x	x	-	-	-
220625	Window (front door front) glass and retainer assembly .....	2	2	2	2	2	2	2	2	-	-	-
220618	Window (front door front) glass retainer front assembly .....	2	2	2	2	2	2	2	2	-	-	-
220633	Window (front door front) glass retainer rear assembly .....	2	2	2	2	2	2	2	2	-	-	-
212366	Screw No. 4 x 3/16 Parker Kalon .....	4	4	4	4	4	4	4	4	-	-	-
220600	Window (front door front) glass retainer pivot spacer .....	x	x	x	x	x	x	x	x	-	-	-
212490	Window (front door front) pivot spring ...	2	2	2	2	2	2	2	2	-	-	-
211409	Window (front door front) pivot spring cap	2	2	2	2	2	2	2	2	-	-	-
220641	Window (front door front) regulator right assembly .....	1	1	1	1	1	1	1	1	-	-	-
220642	Window (front door front) regulator left assembly .....	1	1	1	1	1	1	1	1	-	-	-
7837	Screw 1/4-20 x 7/8 hex. hd. ....	4	4	4	4	4	4	4	4	-	-	-
5502	Lockwasher 1/4 .....	4	4	4	4	4	4	4	4	-	-	-
224542	Window (front door front) regulator handle	2	2	2	2	2	2	2	2	2	2	2
147910	Window (front door front) regulator handle screw .....	2	2	2	2	2	2	2	2	2	2	2
224544	Window (front door front) regulator handle escutcheon plate .....	2	2	2	2	2	2	2	2	2	2	2
180671	Window (front door front) regulator handle insert .....	2	2	2	2	2	2	2	2	2	2	2
226030	Window (front door front) water deflector left .....	1	1	1	1	1	1	1	1	-	-	-
224911	Window (front door front) water deflector right .....	1	1	1	1	1	1	1	1	-	-	-
175763	Screw No. 4 x 3/8 Parker Kalon flat hd. ....	6	6	6	6	6	6	6	6	-	-	-
220650	Window (front door front) weatherstrip right assembly .....	1	1	1	1	1	1	1	1	-	-	-
220651	Window (front door front) weatherstrip left assembly .....	1	1	1	1	1	1	1	1	-	-	-
227698	Window (front door rear) frame and glass assembly right .....	-	-	-	-	-	-	-	-	1	-	1
227699	Window (front door rear) frame and glass assembly left .....	-	-	-	-	-	-	-	-	1	-	1
227746	Window (front door rear) frame and glass assembly-right .....	-	-	-	-	-	-	-	-	-	1	-
227747	Window (front door rear) frame and glass assembly-left .....	-	-	-	-	-	-	-	-	-	1	-
227745	Window (front door rear) glass .....	-	-	-	-	-	-	-	-	-	2	-
227700	Window (front door rear) glass .....	-	-	-	-	-	-	-	-	2	-	2
220624	Window (front door rear) glass .....	-	-	-	-	2	-	-	-	-	-	-
220634	Window (front door rear) glass .....	2	2	2	2	-	2	-	-	-	-	-
228375	Window (front door rear) glass .....	-	-	-	-	-	-	2	-	-	-	-
227704	Window (front door rear) glass frame guide right .....	-	-	-	-	-	-	-	-	1	1	1
227705	Window (front door rear) glass frame guide left .....	-	-	-	-	-	-	-	-	1	1	1
8206	Screw No. 10-32 x 1/2 flat hd. ....	-	-	-	-	-	-	-	-	8	8	8

SERVICE PARTS LIST—PACKARD TWELVE

Window 403

Piece No.	Name	No. Required									
		832 932	833 933	834 934	835 935	836 936	837 937	838 938	839 939	873 973	827 927
228348	Window (front door rear) glass and lifter left assembly .....	-	-	-	-	-	-	1	-	-	-
220654	Window (front door rear) glass and lifter right assembly .....	-	-	-	-	1	-	-	-	-	-
228346	Window (front door rear) glass and lifter right assembly .....	-	-	-	-	-	-	1	-	-	-
220626	Window (front door rear) lifter right assembly .....	-	-	-	-	1	-	-	-	-	-
220628	Window (front door rear) lifter right assembly .....	1	1	1	1	-	1	1	-	-	-
220627	Window (front door rear) lifter left assembly .....	-	-	-	-	1	-	-	-	-	-
220629	Window (front door rear) lifter left assembly .....	1	1	1	1	-	1	1	-	-	-
220622	Window (front door rear) lifter bumper ...	-	-	-	-	2	-	-	-	-	-
220640	Window (front door rear) lifter bumper ...	2	2	2	2	-	2	2	-	-	-
227654	Window (front door rear) regulator right assembly .....	-	-	-	-	-	-	-	1	1	1
227655	Window (front door rear) regulator left assembly .....	-	-	-	-	-	-	-	1	1	1
8206	Screw No. 10-32 x 1/2 flat hd. ....	-	-	-	-	-	-	-	12	-	-
220601	Window (front door rear) regulator right ..	-	-	-	-	1	-	-	-	-	-
220603	Window (front door rear) regulator right ..	1	1	1	1	-	1	1	-	-	-
220602	Window (front door rear) regulator left ..	-	-	-	-	1	-	-	-	-	-
220604	Window (front door rear) regulator left ..	1	1	1	1	-	1	1	-	-	-
8214	Screw 1/4-28 x 3/4 flat hd. ....	8	8	8	8	8	8	8	-	-	-
224540	Window (front door rear) regulator handle.	2	2	2	2	2	2	2	2	-	-
224547	Window (front door rear) regulator handle.	-	-	-	-	-	-	-	-	2	2
224543	Window (front door rear) regulator handle escutcheon plate .....	2	2	2	2	2	2	2	2	2	2
133264	Window (front door rear) regulator handle escutcheon plate spring .....	2	2	2	2	2	2	2	2	2	2
133339	Window (front door rear) regulator handle insert .....	2	2	2	2	2	2	2	2	2	2
132972	Window (front door rear) regulator handle pin .....	2	2	2	2	2	2	2	2	2	2
227656	Window (front door rear) regulator lock board cam right .....	-	-	-	-	-	-	-	1	1	1
227657	Window (front door rear) regulator lock board cam left .....	-	-	-	-	-	-	-	1	1	1
220693	Window (front door rear) runway front lower .....	2	2	2	2	2	2	2	-	-	-
220694	Window (front door rear) runway front upper .....	2	2	2	2	2	2	2	-	-	-
6347	Window (front door rear) runway front upper screw No. 8-32 x 1/4 flat hd. ....	4	4	4	4	4	4	4	-	-	-
175763	Window (front door rear) runway front lower screw No. 4 x 3/8 Parker Kalon flat hd. ....	4	4	4	4	4	4	4	-	-	-
220695	Window (front door rear) runway rear lower	2	2	2	2	2	2	2	-	-	-
220689	Window (front door rear) runway rear upper	-	-	-	-	2	-	-	-	-	-
220698	Window (front door rear) runway rear upper	2	2	2	2	-	2	-	-	-	-
228530	Window (front door rear) runway rear upper	-	-	-	-	-	-	2	-	-	-
136008	Window (front door rear) runway shim 1/32 x 1/2 x 40" .....	x	x	x	x	x	x	x	-	-	-
132429	Window (front door rear) runway shim 1/16 x 1/2 x 40" .....	x	x	x	x	x	x	x	-	-	-
220636	Window (front door rear) runway retainer front right assembly .....	1	1	1	1	1	1	1	-	-	-

Piece No.	Name	No. Required									
		832 932	833 933	834 934	835 935	836 936	837 937	838 938	839 939	873 973	827 927
220636	Window (front door rear) runway retainer front left assembly .....	1	1	1	1	1	1	1	-	-	-
131316	Window (front door rear) stop block bumper	4	4	4	4	4	4	4	-	-	-
227887	Window (front door rear) stop bumper .....	-	-	-	-	-	-	-	2	2	2
8224	Screw No. 10-32 x 5/8 flat hd. ....	-	-	-	-	-	-	-	2	2	2
227385	Window (front door rear) stop bumper bracket .....	-	-	-	-	-	-	-	2	2	2
224214	Window partition anti-rattler front .....	-	-	-	3	-	-	-	-	-	-
199571	Window partition anti-rattler rear .....	-	-	-	2	-	-	-	-	-	-
224129	Window partition glass .....	-	-	-	1	-	-	-	-	-	-
224936	Window partition glass .....	1	-	-	-	-	-	-	-	-	-
227787	Window partition glass sides .....	-	-	-	-	-	-	-	-	1	-
227786	Window partition glass center .....	-	-	-	-	-	-	-	-	1	-
143554	Window partition glass cushion .....	1	-	-	-	-	-	-	-	-	-
224180	Window partition lifter assembly .....	-	-	-	1	-	-	-	-	-	-
224824	Window partition lifter assembly .....	1	-	-	-	-	-	-	-	-	-
224213	Window partition lifter bumper .....	-	-	-	1	-	-	-	-	-	-
224432	Window partition regulator .....	-	-	-	1	-	-	-	-	-	-
224957	Window partition regulator .....	1	-	-	-	-	-	-	-	-	-
227453	Window partition regulator .....	-	-	-	-	-	-	-	-	1	-
224547	Window partition regulator handle .....	1	-	-	1	-	-	-	-	1	-
224543	Window partition regulator handle escutcheon plate .....	1	-	-	1	-	-	-	-	1	-
133264	Window partition regulator handle escutcheon plate spring .....	1	-	-	1	-	-	-	-	1	-
133339	Window partition regulator handle insert .	1	-	-	1	-	-	-	-	1	-
132972	Window partition regulator handle pin ....	1	-	-	1	-	-	-	-	1	-
224781	Window partition runway .....	2	-	-	-	-	-	-	-	-	-
224227	Window partition runway upper .....	-	-	-	1	-	-	-	-	-	-
220696	Window partition runway lower .....	-	-	-	2	-	-	-	-	-	-
227984	Window partition runway upper .....	-	-	-	-	-	-	-	-	2	-
227991	Window partition runway lower .....	-	-	-	-	-	-	-	-	2	-
136008	Window partition runway shim 1/32 x 1/2 x 40" .....	x	-	-	x	-	-	-	-	-	-
132429	Window partition runway shim 1/16 x 1/2 x 40" .....	x	-	-	x	-	-	-	-	-	-
163168	Window partition runway retainer .....	2	-	-	2	-	-	-	-	-	-
131316	Window partition stop block .....	2	-	-	-	-	-	-	-	-	-
227796	Window (rear door) frame and glass assembly right .....	-	-	-	-	-	-	-	-	1	-
227797	Window (rear door) frame and glass assembly left .....	-	-	-	-	-	-	-	-	1	-
227795	Window (rear door) glass .....	-	-	-	-	-	-	-	-	1	-
227798	Window (rear door) regulator assembly right .....	-	-	-	-	-	-	-	-	1	-
227799	Window (rear door) regulator assembly left	-	-	-	-	-	-	-	-	1	-
220530	Window (rear door) glass .....	-	-	2	2	2	-	-	-	-	-
224854	Window (rear door) glass .....	2	2	-	-	-	-	-	-	-	-
220528	Window (rear door) lifter right assembly .	-	-	1	1	1	-	-	-	-	-
224878	Window (rear door) lifter right assembly .	1	1	-	-	-	-	-	-	-	-
220529	Window (rear door) lifter left assembly ..	-	-	1	1	1	-	-	-	-	-
224877	Window (rear door) lifter left assembly ..	1	1	-	-	-	-	-	-	-	-
220621	Window (rear door) lifter bumper .....	-	-	2	2	2	-	-	-	-	-
224857	Window (rear door) lifter bumper .....	2	2	-	-	-	-	-	-	-	-
220526	Window (rear door) regulator right .....	1	1	1	1	1	-	-	-	-	-
220527	Window (rear door) regulator left .....	1	1	1	1	1	-	-	-	-	-
8214	Screw 1/4-28 x 3/4 flat hd. ....	4	4	4	4	4	-	-	-	-	-
8202	Screw 1/4-28 x 7/8 flat hd. ....	2	2	2	2	2	-	-	-	-	-
224547	Window (rear door) regulator handle .....	2	2	2	2	2	-	-	-	2	-

SERVICE PARTS LIST—PACKARD TWELVE

Window 405

Piece No.	Name	No. Required									
		832 932	833 933	834 934	835 935	836 936	837 937	838 938	839 939	873 973	827 927
224543	Window (rear door) regulator handle escutcheon plate .....	2	2	2	2	2	-	-	-	2	-
133264	Window (rear door) regulator handle escutcheon plate spring .....	2	2	2	2	2	-	-	-	2	-
133339	Window (rear door) regulator handle insert	2	2	2	2	2	-	-	-	2	-
132972	Window (rear door) regulator handle pin ..	2	2	2	2	2	-	-	-	2	-
220706	Window (rear door) runway upper .....	-	-	2	2	2	-	-	-	-	-
224858	Window (rear door) runway upper .....	2	2	-	-	-	-	-	-	-	-
220697	Window (rear door) runway lower .....	4	4	-	-	-	-	-	-	-	-
220696	Window (rear door) runway lower .....	-	-	4	4	4	-	-	-	-	-
136008	Window (rear door) runway shim 1/32 x 1/2 x 40" .....	x	x	x	x	x	-	-	-	-	-
132429	Window (rear door) runway shim 1/16 x 1/2 x 40" .....	x	x	x	x	x	-	-	-	-	-
163168	Window (rear door) runway retainer .....	2	2	2	2	2	-	-	-	-	-
220872	Window (rear) finishing rim .....	-	1	1	1	1	1	-	-	-	-
220924	Window (rear) glass .....	-	1	1	1	1	1	-	-	-	-
226223	Window (rear) glass .....	-	-	-	-	-	-	1	-	-	-
226057	Window (rear) glass .....	1	-	-	-	-	-	-	-	-	-
220925	Window (rear) glass cushion .....	-	1	1	1	1	1	-	-	-	-
226305	Window (rear) glass cushion .....	1	-	-	-	-	-	-	-	-	-
226231	Window (rear) lifter assembly .....	-	-	-	-	-	-	1	-	-	-
226235	Window (rear) lifter bumper .....	-	-	-	-	-	-	1	-	-	-
226236	Window (rear) regulator .....	-	-	-	-	-	-	1	-	-	-
226233	Window (rear) regulator handle .....	-	-	-	-	-	-	1	-	-	-
147910	Window (rear) regulator handle screw .....	-	-	-	-	-	-	1	-	-	-
224119	Window (rear) regulator handle escutcheon plate .....	-	-	-	-	-	-	1	-	-	-
180671	Window (rear) regulator handle insert ....	-	-	-	-	-	-	1	-	-	-
226273	Window (rear) runway upper .....	-	-	-	-	-	-	1	-	-	-
226274	Window (rear) runway lower .....	-	-	-	-	-	-	2	-	-	-
136008	Window (rear) runway shim 1/32 x 1/2 x 40"	-	-	-	-	-	-	x	-	-	-
132429	Window (rear) runway shim 1/16 x 1/2 x 40"	-	-	-	-	-	-	x	-	-	-
220660	Window (side) right assembly .....	-	1	-	-	-	-	-	-	-	-
220662	Window (side) right assembly .....	-	-	1	1	-	-	-	-	-	-
220661	Window (side) left assembly .....	-	1	-	-	-	-	-	-	-	-
220663	Window (side) left assembly .....	-	-	1	1	-	-	-	-	-	-
229274	Window (side) drain pan assembly-right ...	-	1	1	1	-	-	-	-	-	-
229273	Window (side) drain pan assembly-left ....	-	1	1	1	-	-	-	-	-	-
229280	Window (side) drain pan tube hose .....	-	2	-	-	-	-	-	-	-	-
229283	Window (side) drain pan tube hose .....	-	-	2	2	-	-	-	-	-	-
211649	Window (side) glass cushion 3/32 thick ...	-	x	x	x	-	-	-	-	-	-
228272	Window (side) glass cushion 1/16 thick ...	-	x	x	x	-	-	-	-	-	-
229324	Window (side) glass cushion (.080 x 1-1/2 everseal) .....	-	x	x	x	-	-	-	-	-	-
220565	Window (side) glass .....	-	2	-	-	-	-	-	-	-	-
220574	Window (side) glass .....	-	-	2	2	-	-	-	-	-	-
226054	Window (side) glass .....	-	-	-	-	-	2	-	-	-	-
220579	Window (side) glass and retainer assembly.	-	2	-	-	-	-	-	-	-	-
220571	Window (side) glass and retainer assembly.	-	-	2	2	-	-	-	-	-	-
220562	Window (side) glass retainer front assembly .....	-	2	-	-	-	-	-	-	-	-
220573	Window (side) glass retainer front assembly .....	-	-	2	2	-	-	-	-	-	-
220560	Window (side) glass retainer rear assembly	-	2	-	-	-	-	-	-	-	-
220572	Window (side) glass retainer rear assembly	-	-	2	2	-	-	-	-	-	-
212366	Screw No. 4 x 3/16 Parker Kalon .....	-	4	4	4	-	-	-	-	-	-
220600	Window (side) glass retainer .....	-	x	x	x	-	-	-	-	-	-
212490	Window (side) glass pivot spring .....	-	2	2	2	-	-	-	-	-	-

Piece No.	Name	No. Required										
		832 932	833 933	834 934	835 935	836 936	837 937	838 938	839 939	873 973	827 927	
211409	Window (side) glass pivot spring cap .....	-	2	2	2	-	-	-	-	-	-	-
220580	Window (side) glass pivot spring plate ...	-	2	-	-	-	-	-	-	-	-	-
220576	Window (side) glass pivot spring plate ...	-	-	2	2	-	-	-	-	-	-	-
140174	Screw No. 10-24 x 5/16 flat hd. ....	-	4	4	4	-	-	-	-	-	-	-
224852	Window (side) lifter right assembly .....	-	-	-	-	-	1	-	-	-	-	-
224853	Window (side) lifter left assembly .....	-	-	-	-	-	1	-	-	-	-	-
226050	Window (side) lifter bumper .....	-	-	-	-	-	2	-	-	-	-	-
220643	Window (side) regulator right assembly ...	-	1	1	1	-	-	-	-	-	-	-
224806	Window (side) regulator right .....	-	-	-	-	-	1	-	-	-	-	-
224805	Window (side) regulator left .....	-	-	-	-	-	1	-	-	-	-	-
220644	Window (side) regulator left assembly ....	-	1	1	1	-	-	-	-	-	-	-
7837	Screw 1/4-20 x 7/8 hex. hd. ....	-	4	4	4	-	-	-	-	-	-	-
8214	Screw 1/4-28 x 3/4 flat hd. ....	-	-	-	-	-	4	-	-	-	-	-
8202	Screw 1/4-28 x 7/8 flat hd. ....	-	-	-	-	-	2	-	-	-	-	-
5502	Lockwasher 1/4 .....	-	4	4	4	-	-	-	-	-	-	-
224542	Window (side) regulator handle .....	-	2	2	2	-	-	-	-	-	-	-
224547	Window (side) regulator handle .....	-	-	-	-	-	2	-	-	-	-	-
147910	Window (side) regulator handle screw .....	-	2	2	2	-	-	-	-	-	-	-
224544	Window (side) regulator handle escutcheon plate .....	-	2	2	2	-	-	-	-	-	-	-
224543	Window (side) regulator handle escutcheon plate .....	-	-	-	-	-	2	-	-	-	-	-
180671	Window (side) regulator handle insert ....	-	2	2	2	-	-	-	-	-	-	-
133339	Window (side) regulator handle insert ....	-	-	-	-	-	2	-	-	-	-	-
132972	Window (side) regulator handle pin .....	-	-	-	-	-	2	-	-	-	-	-
226056	Window (side) runway upper .....	-	-	-	-	-	2	-	-	-	-	-
220695	Window (side) runway lower .....	-	-	-	-	-	4	-	-	-	-	-
136008	Window (side) runway shim 1/32 x 1/2 x 40"	-	-	-	-	-	x	-	-	-	-	-
132429	Window (side) runway shim 1/16 x 1/2 x 40"	-	-	-	-	-	x	-	-	-	-	-
220588	Window (side) weatherstrip right assembly.	-	1	-	-	-	-	-	-	-	-	-
220582	Window (side) weatherstrip right assembly.	-	-	1	1	-	-	-	-	-	-	-
220587	Window (side) weatherstrip left assembly .	-	1	-	-	-	-	-	-	-	-	-
220583	Window (side) weatherstrip left assembly .	-	-	1	1	-	-	-	-	-	-	-

## WINDSHIELD

227673	Windshield base .....	-	-	-	-	-	-	-	1	1	1
5524	Screw 5/16-24 x 1-3/4 flat hd. ....	-	-	-	-	-	-	-	2	2	2
6126	Screw 5/16-24 x 1-7/8 flat hd. ....	-	-	-	-	-	-	-	5	5	5
202909	Screw 5/16-24 x 1-1/2 flat hd. ....	-	-	-	-	-	-	-	2	2	2
229346	Windshield base liner .....	-	-	-	-	-	-	-	1	-	-
227767	Windshield cleaner control cable assembly.	-	-	-	-	-	-	-	2	2	2
220853	Windshield cleaner driver left assembly ..	1	1	1	1	1	1	1	-	-	-
220852	Windshield cleaner driver right assembly .	1	1	1	1	1	1	1	-	-	-
5667	Screw No. 10-32 x 5/8 round hd. ....	4	4	4	4	4	4	4	-	-	-
5935	Lockwasher 3/16 (Shakeproof) .....	4	4	4	4	4	4	4	-	-	-
220851	Pin 3/16 yoke end .....	1	1	1	1	1	1	1	-	-	-
224669	Windshield cleaner driver assembly washer.	1	1	1	1	1	1	1	-	-	-
224670	Windshield cleaner driver assembly washer.	1	1	1	1	1	1	1	-	-	-
4690	Pin 1/16 x 3/8 cotter .....	1	1	1	1	1	1	1	-	-	-
220855	Windshield cleaner driver pinion assembly.	2	2	2	2	2	2	2	-	-	-
6451	Screw No. 6-32 x 5/8 round hd. ....	4	4	4	4	4	4	4	-	-	-
3516	Lockwasher No. 6 .....	4	4	4	4	4	4	4	-	-	-
220854	Windshield cleaner driver pinion assembly gasket .....	2	2	2	2	2	2	2	-	-	-
132878	Windshield cleaner hose .....	-	-	-	-	-	-	-	2	-	-
224435	Windshield cleaner hose .....	1	1	1	1	1	1	1	-	-	-
227778	Windshield cleaner motor and mounting bracket right-assembly .....	-	-	-	-	-	-	-	1	1	1



Piece No.	Name	No. Required									
		832 932	833 934	834 934	835 935	836 936	837 937	838 938	839 939	873 973	827 927
227779	Windshield cleaner motor and mounting bracket left-assembly .....	-	-	-	-	-	-	-	1	1	1
225148	Screw No. 10-32 x 1/2 round hd. ....	-	-	-	-	-	-	-	4	4	4
101200	Washer 3/16 plain .....	-	-	-	-	-	-	-	x	x	x
5500	Lockwasher 3/16 .....	-	-	-	-	-	-	-	4	4	4
227291	Windshield cleaner motor and mounting bracket assembly washer .....	-	-	-	-	-	-	-	2	-	-
220849	Windshield cleaner motor and drivers complete .....	1	1	1	1	1	1	1	-	-	-
220850	Windshield cleaner motor .....	1	1	1	1	1	1	1	-	-	-
5676	Screw No. 10-32 x 3/8 round hd. ....	2	2	2	2	2	2	2	-	-	-
5935	Lockwasher 3/16 (Shakeproof) .....	2	2	2	2	2	2	2	-	-	-
224426	Windshield cleaner motor operating lever ferrule .....	1	1	1	1	1	1	1	-	-	-
177851	Windshield cleaner pillar tube (flared tube connection) adapter .....	1	1	1	1	1	1	1	-	-	-
227760	Windshield cleaner tube right assembly ...	-	-	-	-	-	-	-	1	1	1
227761	Windshield cleaner tube left assembly ....	-	-	-	-	-	-	-	1	1	1
227457	Windshield cleaner tube intermediate assembly .....	-	-	-	-	-	-	-	1	1	1
210070	Windshield cleaner vacuum pump dash connection .....	1	1	1	1	1	1	1	1	1	1
7007	Windshield cleaner vacuum pump dash connection nut 7/16-20 .....	1	1	1	1	1	1	1	1	1	1
5806	Lockwasher 7/16 (Shakeproof) .....	1	1	1	1	1	1	1	1	1	1
3883	Washer 7/16 .....	1	1	1	1	1	1	1	1	1	1
225629	Windshield cleaner vacuum pump to dash connection tube assembly .....	1	1	1	1	1	1	1	1	1	1
6399	Union nut 1/4 flared tube .....	1	1	1	1	1	1	1	1	1	1
6344	Nut 1/4 flared tube (inverted) weatherhead .....	1	1	1	1	1	1	1	1	1	1
7824	Windshield cleaner vacuum pump to dash connection tube assembly screw 1/4-28 x 5/8 hex. hd. ....	2	2	2	2	2	2	2	2	2	2
5451	Screw 5/16-24 x 1-1/2 hex. hd. ....	1	1	1	1	1	1	1	1	1	1
5502	Lockwasher 1/4 .....	2	2	2	2	2	2	2	2	2	2
7004	Nut 1/4-28 .....	2	2	2	2	2	2	2	2	2	2
3909	Washer 5/16 special .....	1	1	1	1	1	1	1	1	1	1
5504	Lockwasher 5/16 .....	1	1	1	1	1	1	1	1	1	1
7005	Nut 5/16-24 .....	1	1	1	1	1	1	1	1	1	1
163067	Windshield cleaner vacuum pump to dash connection tube assembly clip .....	3	3	3	3	3	3	3	3	3	3
143130	Clip .....	1	1	1	1	1	1	1	1	1	1
201721	Screw No. 14 x 3/4 R. H. Parker Kalon. 5373 Screw 1/4-28 x 1-3/8 hex. hd. ....	1	1	1	1	1	1	1	1	1	1
62065	Washer 1/4 .....	1	1	1	1	1	1	1	1	1	1
6279	Windshield cleaner vacuum pump to dash connection tube elbow .....	1	1	1	1	1	1	1	1	1	1
228940	Windshield cleaner vacuum pump to dash connection tube hose assembly .....	1	1	1	1	1	1	1	1	1	1
220860	Windshield cleaner wiper .....	2	2	2	2	2	2	2	-	-	-
227780	Windshield cleaner wiper .....	-	-	-	-	-	-	-	2	2	2
227794	Windshield cleaner wiper arm right .....	-	-	-	-	-	-	-	1	1	1
227781	Windshield cleaner wiper arm left .....	-	-	-	-	-	-	-	1	1	1
220859	Windshield cleaner wiper arm .....	2	2	2	2	2	2	2	-	-	-
224668	Windshield cleaner wiper arm nut .....	2	2	2	2	2	2	2	-	2	2
227782	Windshield cleaner wiper arm nut .....	-	-	-	-	-	-	-	2	2	2
220844	Windshield finishing rim .....	1	1	1	1	1	1	1	-	-	-
227666	Windshield finishing rim lower .....	-	-	-	-	-	-	-	1	1	1

Piece No.	Name	No. Required									
		832 932	833 933	834 934	835 935	836 936	837 937	838 938	839 939	873 973	827 927
227667	Windshield finishing rim upper .....	-	-	-	-	-	-	-	1	1	1
227664	Windshield finishing rim side right .....	-	-	-	-	-	-	-	1	1	1
227665	Windshield finishing rim side left .....	-	-	-	-	-	-	-	1	1	1
220846	Windshield glass .....	1	1	1	1	1	1	1	-	-	-
227672	Windshield glass .....	-	-	-	-	-	-	-	1	1	1
227820	Windshield glass cushion side .....	-	-	-	-	-	-	-	2	2	2
227819	Windshield glass cushion upper .....	-	-	-	-	-	-	-	2	2	2
227822	Windshield glass cushion lower .....	-	-	-	-	-	-	-	2	2	2
220845	Windshield glass cushion .....	1	1	1	1	1	1	1	-	-	-
220847	Windshield glass retainer .....	1	1	1	1	1	1	1	-	-	-
223142	Screw No. 6-32 x 1/4 flat hd. ....	-	-	-	-	-	-	-	16	-	-
227370	Windshield glass retainer upper .....	-	-	-	-	-	-	-	1	1	1
227461	Windshield glass retainer lower .....	-	-	-	-	-	-	-	1	1	1
227462	Windshield glass retainer side right .....	-	-	-	-	-	-	-	1	1	1
227463	Windshield glass retainer side left .....	-	-	-	-	-	-	-	1	1	1
227674	Windshield stanchion right .....	-	-	-	-	-	-	-	1	1	1
227675	Windshield stanchion left .....	-	-	-	-	-	-	-	1	1	1
228232	Screw 7/16-14 x 2-1/2 hex. hd. ....	-	-	-	-	-	-	-	2	2	2
5508	Lockwasher 7/16 .....	-	-	-	-	-	-	-	2	2	2
7005	Nut 5/16-24 .....	-	-	-	-	-	-	-	4	-	-
3874	Washer 5/16 .....	-	-	-	-	-	-	-	4	-	-
5504	Lockwasher 5/16 .....	-	-	-	-	-	-	-	4	-	-
227723	Washer .....	-	-	-	-	-	-	-	2	2	2
6457	Screw 5/16-24 x 2-1/2 flat hd. ....	-	-	-	-	-	-	-	2	2	2
228234	Screw 5/16-24 x 2-3/4 flat hd. ....	-	-	-	-	-	-	-	2	-	-
228237	Screw 5/16-24 x 2" flat hd. ....	-	-	-	-	-	-	-	4	4	4

TRIMMING

To avoid errors due to difference in texture and shade, please furnish sample when ordering trimming material.

139910	Binding cloth wire on (Specify set number)	x	x	x	x	x	x	x	-	-	-
228406	Binding cloth wire on (Top fabric)	-	-	-	-	-	-	-	x	-	-
	(Specify set number) .....	-	-	-	-	-	-	-	-	-	-
167438	Binding cloth wire on (Cordless) 1/2" wide	x	-	-	-	-	-	-	-	-	-
	(Specify set number) .....	-	-	-	-	-	-	-	-	-	-
156689	Binding 1-1/8" leather colonial grain	-	-	-	-	-	-	x	-	-	-
	(Specify set number) .....	-	-	-	-	-	-	-	-	-	-
226981	Binding 1-1/8" leather natural grain	-	-	-	-	-	-	-	x	-	-
	(Specify set number) .....	-	-	-	-	-	-	-	-	-	-
192037	Binding 1-1/2" leather-skiver grain	-	-	-	-	-	x	-	-	-	-
	(Specify set number) .....	-	-	-	-	-	-	-	-	-	-
156596	Binding lace 7/16 (Specify set number) ...	-	-	-	-	-	-	-	x	-	-
206731	Binding rattan 3/8" half rd. ....	-	x	x	x	-	-	-	-	-	-
226169	Binding weatherstrip (Specify set number).	x	x	x	x	x	x	x	-	-	-
5579	Brad No. 19 x 3/4 (Taper hd.) .....	x	x	x	x	x	x	x	-	-	-
5738	Brad No. 20 x 1/2" (Taper hd.) .....	x	x	x	x	x	x	x	-	-	-
29595	Burlap 10 oz. 40" wide .....	x	x	x	x	x	x	-	-	-	-
200996	Carpet rubber set 36" wide (uncut pile)	-	-	-	-	-	x	x	x	-	-
	(Specify set number) .....	-	-	-	-	-	-	-	-	-	-
200995	Carpet rubber set 36" wide (cut pile)	-	-	-	-	-	-	-	x	-	-
	(Specify set number) .....	-	-	-	-	-	-	-	-	-	-
29651	Cloth cotton 36" wide .....	x	x	x	x	x	x	x	-	-	-
29790	Cord window curtain guide (Specify set number) .....	x	x	x	x	x	x	x	-	-	-

Piece No.	Name	No. Required									
		832 932	833 933	834 934	835 935	836 936	837 937	838 938	839 939	873 973	827 927
226982	Cord welt 3/4 x 1/4 natural leather (Specify set number) .....	-	-	-	-	-	-	-	X	-	-
159187	Cord welt 3/4 x 1/4 colonial leather (Specify set number) .....	-	-	-	X	-	-	X	-	-	-
156696	Cord welt 11/16 x 3/16 leather colonial grain (Specify set number) .....	-	-	-	X	-	-	-	-	-	-
226983	Cord welt 11/16 x 3/16 leather natural grain (Specify set number) .....	-	-	-	-	-	-	-	X	-	-
127253	Cord welt seaming lace 9/32 x 5/8 (Specify set number) .....	X	X	X	X	X	X	X	-	-	-
214378	Cord welt seaming lace 9/32 x 1 (Specify set number) .....	X	X	X	X	X	X	X	-	-	-
173243	Cord welt seaming lace 11/16 x 3/16 (Specify set number) .....	X	X	X	X	X	X	X	-	-	-
161787	Drill white cotton 7 oz. 36" wide .....	X	X	X	X	X	X	X	X	-	-
200525	Duck black double filled 1.35-50" .....	X	X	X	X	X	X	X	X	-	-
200467	Fabric top material 54" wide) .....	-	-	-	-	-	-	-	X	-	-
185211	Fabric-upholstering 58" wide (Specify set number) .....	X	X	X	X	X	X	X	-	-	-
174513	Fabric 54" filled mole skin (Specify set number) .....	X	X	X	X	X	X	X	X	-	-
184863	Fabric-roof covering 45" wide turtle grain	X	-	-	-	-	-	-	-	-	-
218169	Fabric-roof covering 45" wide vox grain ..	-	X	X	X	X	X	X	-	-	-
218170	Fabric-roof covering 45" wide vox grain ..	-	X	X	X	X	X	X	-	-	-
156857	Gimp 3/4 bias cut imitation leather colonial grain (Specify set number) ....	X	X	X	X	X	X	X	-	-	-
228406	Gimp 3/4 fabric top material .....	-	-	-	-	-	-	-	X	-	-
156692	Gimp 1/2" imitation black colonial leather	X	X	X	X	X	X	X	X	-	-
206193	Gimp 3/4 leather skiver grain (Specify set number) .....	-	-	-	-	X	-	-	-	-	-
214054	Hair interlaced 52" wide (wt. 5 oz. plus or minus 1/4 oz. per sq. ft.) .....	-	-	X	X	-	-	-	X	-	-
127473	Hair-Wilson and Co. super bovine or its equivalent .....	X	-	-	-	X	-	X	X	-	-
214109	Leather imitation 52" wide color-black ...	-	-	-	-	X	-	-	-	-	-
123507	Leather imitation .....	-	-	-	-	-	-	X	-	-	-
156346	Leather imitation colonial grain (Specify set number) .....	X	X	X	X	X	X	X	-	-	-
226917	Leather trimming natural grain (Specify set number) .....	-	-	-	X	-	-	X	X	-	-
226918	Leather imitation natural grain (Specify set number) .....	-	-	-	X	-	-	X	X	-	-
183986	Leather turtle grain landau 10 to 10-1/2 oz. black .....	X	-	-	-	-	-	-	-	-	-
161778	Leather binding .020 thick .....	-	X	X	X	-	-	-	-	-	-
192303	Muslin rubber 54" wide .....	X	X	X	X	X	X	X	X	-	-
140935	Paper board 1/2 x 48" .....	X	X	X	X	X	X	X	-	-	-
135117	Paper board shim 1/16 x 1 x 36 .....	X	X	X	X	X	X	X	-	-	-
182894	Paper cord 1/4 twisted .....	X	X	X	X	X	X	X	X	-	-
211171	Plush high pile worsted .....	X	X	X	X	X	X	-	-	-	-
224304	Rubber strip-door weatherstrip .....	X	X	X	X	X	X	X	X	-	-
228320	Rubber riser 1/2 half round .....	X	X	X	X	X	X	-	X	-	-
113983	Silk curtain 22" wide .....	X	X	X	X	X	X	X	-	-	-
206657	Tacks-upholsters (Specify set number) ....	4	4	8	8	-	4	-	-	-	-
29637	Thread No. EE spool silk .....	X	X	X	X	X	X	X	X	-	-
192345	Thread No. 18 linen .....	X	X	X	X	X	X	X	X	-	-
192346	Thread No. 25 linen .....	X	X	X	X	X	X	X	X	-	-
29638	Thread "A" spool silk .....	X	X	X	X	X	X	X	X	-	-
29640	Thread "EE" No. 18 or Dean and Sheck No. 12-4 .....	X	X	X	X	X	X	X	X	-	-

Piece No.	Name	No. Required									
		832 932	833 933	834 934	835 935	836 936	837 937	838 938	839 939	873 973	827 927
127808	Thread-Dean and Sheck No. 20-A silk finish	X	X	X	X	X	X	X	X	-	-
157022	Thread-Lincoln No. 6	X	X	X	X	X	X	X	X	-	-
157586	Thread No. 1201 cord	X	X	X	X	X	X	X	X	-	-
200638	Thread No. 80-3 hard finish cotton	X	X	X	X	X	X	X	X	-	-
200639	Thread No. 90-3 hard finish cotton	X	X	X	X	X	X	X	X	-	-
29625	Twine No. 252 Yazoo	X	X	X	X	X	X	X	X	-	-
29627	Wadding 33" blue sheet No. 532	X	X	X	X	X	X	X	X	-	-
182687	Wadding 32" white unbleached No. 532	-	-	-	-	-	-	-	X	-	-
214213	Wadding 8" white cotton rolled 9-1/2 oz.	X	X	X	X	X	X	X	X	-	-
128040	Wadding 33" white sheet	X	X	X	X	X	X	X	X	-	-
183741	Wadding roof 41" wide 13-1/2 oz.	X	X	X	X	X	X	X	X	-	-
172470	Wadding 4" white cotton unbleached rolled 5 oz.	X	X	X	X	X	X	X	X	-	-
139457	Wadding white cotton unbleached 6" rolled 7 oz.	-	-	-	-	-	-	X	X	-	-
193352	Webbing-elastic 2" wide	-	X	X	-	X	-	X	X	-	-
62759	Webbing-jute 3" wide	-	-	X	X	-	-	-	X	-	-
214562	Windlace cloth (Specify set number)	X	X	X	X	X	X	X	X	-	-
228407	Windlace leather natural grain (Specify set number)	-	-	-	-	-	-	-	X	-	-
226161	Wire No. 13 W and M Ga. .0915	-	X	X	X	-	-	-	-	-	-
226168	Wire No. 30 music	X	X	X	X	X	X	X	X	-	-
218198	Assembly carpet floor front (Specify set number) (Use with Bucket type seat)	-	-	-	-	-	1	-	-	-	-
229772	Assembly carpet floor front (Specify set number) (Use with straight across front seat)	-	-	-	-	-	1	-	-	-	-
228193	Assembly carpet floor front (Specify set number)	1	-	-	1	-	-	-	-	-	-
229744	Assembly carpet floor front (Specify set number) (38-1/2" long at center)	-	-	-	-	-	-	1	-	-	-
228196	Assembly carpet floor front (Specify set number) (36-1/2" long at center)	-	1	1	-	1	-	1	-	-	-
229746	Assembly carpet floor front (Specify set number) (38-1/2" long at center)	-	-	-	-	-	-	-	1	-	-
228463	Assembly carpet floor front (Specify set number) (36-1/2" long at center)	-	-	-	-	-	-	-	1	-	-
218181	Assembly carpet floor rear (Specify set number)	-	-	1	-	-	-	-	-	-	-
218183	Assembly carpet floor rear (Specify set number)	-	-	-	1	-	-	-	-	-	-
218176	Assembly carpet floor rear (Specify set number)	-	1	-	-	-	-	-	-	-	-
218186	Assembly carpet floor rear (Specify set number)	-	-	-	-	1	-	-	-	-	-
218178	Assembly carpet floor rear (Specify set number)	1	-	-	-	-	-	-	-	-	-
218188	Assembly carpet floor rear (Specify set number) (Use with Bucket type seat)	-	-	-	-	-	1	-	-	-	-
218188	Assembly carpet floor rear (Specify set number) (Use with straight across front seat)	-	-	-	-	-	1	-	-	-	-
229705	Assembly carpet rumble seat compartment floor (Specify set number)	-	-	-	-	-	-	-	1	-	-
229565	Assembly carpet rumble seat compartment floor (Specify set number)	-	-	-	-	-	-	1	-	-	-
224416	Assembly cowl trim panel right (Specify set number)	-	-	-	1	-	-	-	1	-	-
224415	Assembly cowl trim panel left (Specify set number)	-	-	-	1	-	-	-	-	-	-

SERVICE PARTS LIST—PACKARD TWELVE

Trimming 411

Piece No.	Name	No. Required									
		832 932	833 933	834 934	835 935	836 936	837 937	838 938	839 939	873 973	827 927
228468	Assembly cowl trim panel left (Specify set number) .....	-	-	-	-	-	-	-	1	-	-
226691	Assembly cowl trim panel left (Specify set number) .....	1	1	1	-	1	1	1	-	-	
226690	Assembly cowl trim panel right (Specify set number) .....	1	1	1	-	1	1	1	-	-	
226174	Assembly door trimming front left (Specify set number) .....	1	1	1	-	-	-	-	-	-	
226458	Assembly door trimming front left (Specify set number) .....	-	-	-	-	-	1	1	-	-	
226462	Assembly door trimming front left (Specify set number) .....	-	-	-	-	1	-	-	-	-	
228474	Assembly door trimming front left (Specify set number) .....	-	-	-	-	-	-	-	1	-	
226468	Assembly door trimming front left (Specify set number) .....	-	-	-	1	-	-	-	-	-	
226461	Assembly door trimming front right (Specify set number) .....	-	-	-	-	1	-	-	-	-	
228471	Assembly door trimming front right (Specify set number) .....	-	-	-	-	-	-	-	1	-	
226173	Assembly door trimming front right (Specify set number) .....	1	1	1	-	-	-	-	-	-	
226457	Assembly door trimming front right (Specify set number) .....	-	-	-	-	-	1	1	-	-	
226467	Assembly door trimmig front right (Specify set number) .....	-	-	-	1	-	-	-	-	-	
226474	Assembly door trimming rear left (Specify set number) .....	1	1	-	-	-	-	-	-	-	
226176	Assembly door trimming rear left (Specify set number) .....	-	-	1	1	1	-	-	-	-	
226473	Assembly door trimming rear right (Specify set number) .....	1	1	-	-	-	-	-	-	-	
226175	Assembly door trimming rear right (Specify set number) .....	-	-	1	1	1	-	-	-	-	
226481	Assembly door trimming rear right (Specify set number) .....	-	1	-	-	-	-	-	-	-	
226649	Assembly head lining (Specify set number) .....	1	-	-	-	-	-	-	-	-	
226650	Assembly head lining (Specify set number) .....	-	1	-	-	-	-	-	-	-	
226188	Assembly head lining (Specify set number) .....	-	-	1	-	-	-	-	-	-	
226651	Assembly head lining (Specify set number) .....	-	-	-	-	1	-	-	-	-	
226652	Assembly head lining (Specify set number) .....	-	-	-	-	-	1	-	-	-	
226653	Assembly head lining (Specify set number) .....	-	-	-	-	-	-	1	-	-	
226654	Assembly head lining front compartment (Specify set number) .....	-	-	-	1	-	-	-	-	-	
226655	Assembly head lining rear (Specify set number) .....	-	-	-	1	-	-	-	-	-	
229577	Fastener stud (double) woodscrew - top rear curtain .....	-	-	-	-	-	-	-	5	-	
229578	Fastener eyelet long--top rear curtain .....	-	-	-	-	-	-	-	5	-	
229579	Fastener eyelet washer-top rear curtain .....	-	-	-	-	-	-	-	5	-	
112054	Snap fastener button-cowl panel tab. ....	2	2	2	2	2	2	2	-	-	
115799	Snap fastener socket-carpet front floor ..	-	-	-	-	-	-	-	12	-	
137510	Snap fastener socket-cowl panel tab. ....	2	2	2	2	2	2	2	-	-	
115798	Snap fastener socket ring (short prong) carpet front floor .....	-	-	-	-	-	-	-	12	-	
214974	Snap fastener socket-top side quarter ....	-	-	-	-	-	-	-	8	-	
193201	Snap fastener stud (drive screw) carpet front floor .....	4	4	4	4	4	4	4	4	-	
112058	Snap fastener stud (wood screw) .....	6	8	14	14	4	9	-	-	-	

Piece No	Name	No. Required									
		832 932	833 933	834 934	835 935	836 936	837 937	838 938	839 939	873 973	827 927
206744	Snap fastener stud (drive screw) rumble seat compartment floor .....	-	-	-	-	-	-	8	8	-	-
111074	Snap fastener stud (eyelet type) carpet front floor .....	6	6	6	6	6	6	6	6	-	-
111075	Snap fastener stud (eyelet) carpet front floor .....	6	6	6	6	6	6	6	6	-	-
193200	Snap fastener stud (machine screw) carpet front floor .....	2	2	2	2	2	2	2	2	-	-
228144	Snap fastener stud (machine screw post) top .....	-	-	-	-	-	-	-	2	-	-
193199	Snap fastener stud (rivet) carpet front floor .....	2	2	2	2	2	2	2	2	-	-
185412	Snap fastener stud woodscrew-top envelope.	-	-	-	-	-	-	-	18	-	-
175757	Snap fastener eyelet-top envelope .....	-	-	-	-	-	-	-	18	-	-
175757	Snap fastener eyelet-top side quarter ....	-	-	-	-	-	-	-	8	-	-
139150	Snap fastener socket-top envelope .....	-	-	-	-	-	-	-	18	-	-
200073	Snap fastener socket-rumble seat compartment floor carpet .....	-	-	-	-	-	-	8	8	-	-

PACKARD  
SERVICE PARTS LIST

SPECIAL MODELS

906-S - 1006-S - 1105-S  
1106 - 1106-S - 1108-S

*Issued April, 1934*

Copyrighted 1934

PACKARD MOTOR CAR COMPANY  
DETROIT, MICHIGAN

## BODY TYPES

906-S	1006-S	1105-S	1106	1106-S	1108-S	Pass.	Description	Made By
.....	.....	280	.....	.....	.....	4	Sport Phaeton.....	Le Baron
.....	.....	.....	.....	275	.....	2	Sport Runabout.....	Le Baron
.....	.....	.....	.....	.....	280	4	Sport Phaeton.....	Le Baron
.....	3068	.....	.....	.....	4068	2	Coupe .....	Dietrich
.....	3069	.....	.....	.....	4069	4-5	Sport Phaeton.....	Dietrich
.....	3070	.....	.....	.....	4070	5	Convertible Sedan.....	Dietrich
.....	3071	.....	.....	.....	4071	2	Convertible Coupe Roadster..	Dietrich
.....	3072	.....	.....	.....	4072	4	Convertible Victoria.....	Dietrich
.....	3182	.....	.....	.....	4182	5	Formal Sedan.....	Dietrich

## ORDERING PARTS

Only special parts used on the models designated are listed in this book. Items not listed are the same as standard.

This chart shows the special chassis models and the corresponding standard chassis models.

SPECIAL	STANDARD
906-S	906
1006-S	1006
1105-S	1105
1108	1107
1106-S	1107
1108-S	1108

\*If item required is not listed herein, refer to standard parts book, in accordance with model cross reference, and order standard parts.

Use Standard Distributer's Sundry and Part Order forms No. D-19.

Furnish motor and vehicle number in every case when ordering special parts not listed, also when ordering trim or trimmed parts and painted parts.

Body parts not listed should be ordered by description.

SERVICE DEPARTMENT  
 PACKARD MOTOR CAR COMPANY  
 DETROIT, MICHIGAN, U. S. A.



Piece No.	Name	No. Required					
		906-S	1006-S	1105-S	1106	1106-S	1108-S
<b>CHASSIS PARTS</b>							
<b>BONNET</b>							
215296	Bonnet assembly .....	-	-	-	1	-	-
215319	Bonnet assembly (with chromium doors) .....	-	-	-	1	-	-
216218	Bonnet assembly (Used with bodies 275-280-4182) .....	-	-	1	-	1	1
98269	Bonnet assembly (Used with body 3182) .....	-	1	-	-	-	-
98270	Bonnet assembly (Used with bodies 3068-70-71-72) .....	-	1	-	-	-	-
219398	Bonnet assembly (Used with bodies 4068-70-71-72) .....	-	-	-	-	-	1
207299	Bonnet assembly (Used with body 3069) .....	-	1	-	-	-	-
215295	Bonnet assembly (Used with body 4068) .....	-	1	-	-	-	-

Note: All detail parts for bonnet assemblies 216218-219398-98269 and 98270 Special

205937	Bonnet clamp bracket rear right .....	-	-	-	1	-	-
219700	Bonnet clamp bracket rear right (Used with bodies 275-280) ..	-	-	1	-	1	1
205938	Bonnet clamp bracket rear left .....	-	-	-	1	-	-
219701	Bonnet clamp bracket rear left (Used with bodies 275-280) ...	-	-	1	-	1	1
219561	Bonnet side right and door assembly .....	-	-	-	1	-	-

### BRAKE

207556	Brake assembly-front right .....	-	-	-	1	-	-
207555	Brake assembly-front left .....	-	-	-	1	-	-
207558	Brake assembly-rear right .....	-	-	-	1	-	-
207557	Brake assembly-rear left .....	-	-	-	1	-	-
7819	Brake assembly front bolt (Screw 3/8-24 x 1" hex. hd.) .....	-	-	-	12	-	-
5506	Lockwasher 3/8" .....	-	-	-	12	-	-
7006	Nut 3/8-24 .....	-	-	-	12	-	-
209892	Brake cable and conduit assembly-front .....	-	-	-	2	-	-
209896	Brake cable and conduit assembly-rear .....	-	-	-	2	-	-
219489	Brake lever splasher assembly (Used with bodies 4068-69-70-71-72-4182-275-280) .....	-	-	1	-	1	1
196969	Brake pedal retracting spring .....	-	-	-	1	-	-
209640	Brake pedal retracting spring clip .....	-	-	-	1	-	-
207722	Brake shaft .....	-	-	-	1	-	-
202720	Brake shoe hold down spring pin .....	-	-	-	16	-	-
210268	Brake shoe and lining assembly front right and rear right and left-primary .....	-	-	-	3	-	-
210267	Brake shoe and lining assembly front right and rear right and left-secondary .....	-	-	-	3	-	-
210266	Brake shoe and lining assembly front left-primary .....	-	-	-	1	-	-
210265	Brake shoe and lining assembly front left-secondary .....	-	-	-	1	-	-
210005	Brake shoe lining front right and rear right and left-primary .....	-	-	-	3	-	-
210006	Brake shoe lining front right and rear right and left-secondary .....	-	-	-	3	-	-
210225	Brake shoe lining front left-primary .....	-	-	-	1	-	-
210226	Brake shoe lining front left-secondary .....	-	-	-	1	-	-
210285	Brake front support plate assembly-right .....	-	-	-	1	-	-
210284	Brake front support plate assembly-left .....	-	-	-	1	-	-
210287	Brake rear support plate assembly-right .....	-	-	-	1	-	-
210286	Brake rear support plate assembly-left .....	-	-	-	1	-	-
209635	Brake support plate water seal .....	-	-	-	4	-	-
209676	Brake support plate water seal and brackets assembly .....	-	-	-	4	-	-

### BUMPER

215693	Bumper and stabilizer assembly-front .....	-	-	-	1	-	-
215693	Bumper and stabilizer assembly-front (Use with bodies 4068-4182) .....	-	-	-	-	-	1
194071	Bumper and stabilizer assembly-front (Use with bodies 3068-3182) .....	-	1	-	-	-	-

\* For items not listed herein see instructions on Page 2.

Piece No.	Name	No. Required					
		906-S	1006-S	1105-S	1106	1106-S	1108-S
215694	Bumper and stabilizer assembly-front (Use with bodies 4069-70-71-72) .....	-	-	-	-	-	1
213809	Bumper and stabilizer assembly-front (Use with bodies 3069-70-71-72) .....	-	1	-	-	-	-
219423	Bumper assembly-rear (Use with body 280) .....	-	-	1	-	-	-
219471	Bumper assembly-rear (Use with body 275) (Not used with wheel carrier) .....	-	-	-	-	1	-
219376	Bumper assembly-rear (Use with body 275) (Used with wheel carrier) .....	-	-	-	-	1	-
219409	Bumper assembly-rear (Use with body 280) .....	-	-	-	-	-	1
219411	Bumper bracket-rear-left (Use with body 280) .....	-	-	1	-	-	1
219410	Bumper bracket-rear-right (Use with body 280) .....	-	-	1	-	-	1
7951	Bumper bracket rear bolt (7/16-20 x 1-1/4" hex. hd.) (Use with body 280) .....	-	-	2	-	-	2
7007	Bumper bracket rear bolt nut (7/16-20) (Use with body 280) ..	-	-	2	-	-	2
5508	Bumper bracket rear bolt lock washer 7/16" (Use with body 280) .....	-	-	2	-	-	2
7886	Bumper bracket rear screw 7/16-20 x 1-3/4" hex. hd. (Use with body 280) .....	-	-	4	-	-	4
6608	Bumper bracket rear screw lock washer 7/16" (Use with body 280) .....	-	-	4	-	-	4
215345	Bumper clamp plate rear assembly (Not used on wheel carrier for 275) .....	-	-	-	-	2	2
191437	Bumper clamp plate rear (Use with body 275) (Use with wheel carrier) .....	-	-	-	-	2	-
215661	Bumper clamp plate rear cover (Not used with wheel carrier for 275) .....	-	-	-	-	2	2
191439	Bumper clamp plate rear cover (Use with body 275 - with wheel carrier) .....	-	-	-	-	2	-
194549	Bumper front end stabilizer spring-inner .....	-	-	-	4	-	-
194549	Bumper front end stabilizer spring-inner (Use with bodies 3068-3182-4068-4182) .....	-	4	-	-	-	4
213808	Bumper front end stabilizer spring-inner (Use with bodies 3069-70-71-72-4069-70-71-72) .....	-	4	-	-	-	4
194548	Bumper front end stabilizer spring-outer .....	-	-	-	4	-	-
194548	Bumper front end stabilizer spring-outer (Use with bodies 3068-3182-4068-4182) .....	-	4	-	-	-	4
213807	Bumper front end stabilizer spring-outer (Use with bodies 3068-70-71-72-4069-70-71-72) .....	-	4	-	-	-	4
219412	Bumper rear support plate gasket (Use with body 280) .....	-	-	2	-	-	2

## EXHAUST

216571	Exhaust muffler assembly .....	-	-	-	1	-	-
219584	Exhaust muffler heat deflector assembly .....	-	-	-	1	-	-
216572	Exhaust muffler outlet tube assembly .....	-	-	-	1	-	-

## FRAME

216566	Frame assembly .....	-	-	-	1	-	-
215267	Frame battery support front assembly .....	-	-	-	1	-	-
215279	Frame battery support rear assembly .....	-	-	-	1	-	-
215355	Frame front intermediate channel assembly .....	-	-	-	1	-	-
213955	Frame rear channel (Use with body 3182) .....	-	1	-	-	-	-
215364	Frame side-left .....	-	-	-	1	-	-
215365	Frame side-right .....	-	-	-	1	-	-

## FRONT AXLE

216895	Front axle steering knuckle-left .....	-	-	-	1	-	-
216896	Front axle steering knuckle-right .....	-	-	-	1	-	-
201027	Front axle steering knuckle lever-left .....	-	-	-	1	-	-

\* For items not listed herein see instructions on Page 2.

Piece No.	Name	No. Required					
		906-S	1006-S	1105-S	1106	1106-S	1108-S
216893	Front axle steering knuckle oil guard .....	-	-	-	2	-	-

**FENDERS**

216358	Front fender right assembly (with well) (Use with bodies 4068-70-1-2-4182) .....	-	-	-	-	-	1
216357	Front fender left assembly (with well) (Use with bodies 4068-70-1-2-4182) .....	-	-	-	-	-	1

REAR FENDERS FOR BODIES 275-280 \* SPECIAL LE BARON

212345	Rear fender left assembly (Use with body 3070) .....	-	1	-	-	-	-
214995	Rear fender left assembly (Use with body 4070) .....	-	-	-	-	-	1
212353	Rear fender left assembly (Use with body 3182) .....	-	1	-	-	-	-
214999	Rear fender left assembly (Use with body 4182) .....	-	-	-	-	-	1
212359	Rear fender left assembly (Use with body 3069) .....	-	1	-	-	-	-
214993	Rear fender left assembly (Use with body 4069) .....	-	-	-	-	-	1
212355	Rear fender left assembly (Use with body 3068-3071) .....	-	1	-	-	-	-
214991	Rear fender left assembly (Use with body 4068-4071) .....	-	-	-	-	-	1
212357	Rear fender left assembly (Use with body 3072) .....	-	1	-	-	-	-
214997	Rear fender left assembly (Use with body 4072) .....	-	-	-	-	-	1
212354	Rear fender right assembly (Use with body 3182) .....	-	1	-	-	-	-
214998	Rear fender right assembly (Use with body 4182) .....	-	-	-	-	-	1
212344	Rear fender right assembly (Use with body 3070) .....	-	1	-	-	-	-
214994	Rear fender right assembly (Use with body 4070) .....	-	-	-	-	-	1
212360	Rear fender right assembly (Use with body 3069) .....	-	1	-	-	-	-
214992	Rear fender right assembly (Use with body 4069) .....	-	-	-	-	-	1
212358	Rear fender right assembly (Use with body 3072) .....	-	1	-	-	-	-
214996	Rear fender right assembly (Use with body 4072) .....	-	-	-	-	-	1
212356	Rear fender right assembly (Use with body 3068-3071) .....	-	1	-	-	-	-
214990	Rear fender right assembly (Use with body 4068-4071) .....	-	-	-	-	-	1
212156	Rear fender to body liner (Use with bodies 3068-69-71-72-4068-69-70-71-72-4182) .....	-	2	-	-	-	2
211784	Rear fender to body liner (Use with bodies 3070-3182) .....	-	2	-	-	-	-
5286	Rear fender to trunk screw #10-32 x 1" rnd hd. (Use with body 4072) .....	-	-	-	-	-	6
3867	Washer 3/16" special (Use with body 4072) .....	-	-	-	-	-	6
5500	Lockwasher #10 (Use with body 4072) .....	-	-	-	-	-	6
7003	Nut #10-32 (Use with body 4072) .....	-	-	-	-	-	6

**GASOLINE**

219602	Gasoline tank assembly (Use with body 275) .....	-	-	-	-	-	1
213945	Gasoline tank assembly (Use with body 3182) .....	-	1	-	-	-	-
210654	Gasoline tank to frame rear channel bracket spacer (Use with body 275) .....	-	-	-	-	-	x
219443	Gasoline tank to frame rear intermediate channel bracket-lower (Use with body 275) .....	-	-	-	-	-	2
219444	Gasoline tank to frame rear intermediate channel bracket-upper (Use with body 275) .....	-	-	-	-	-	2
210252	Gasoline tank to frame rear channel bracket-lower (Use with body 275) .....	-	-	-	-	-	1
210251	Gasoline tank to frame rear channel bracket-upper (Use with body 275) .....	-	-	-	-	-	1
210654	Gasoline tank to frame rear intermediate channel bracket spacer (Use with body 275) .....	-	-	-	-	-	4
219616	Gasoline tank inlet bushing (Use with body 275) .....	-	-	-	-	-	1
219629	Gasoline tank inlet cap assembly-right (Use with body 275) .....	-	-	-	-	-	1
219626	Gasoline tank inlet cap assembly-left (Use with body 275) .....	-	-	-	-	-	1

\* For items not listed herein see instructions on Page 2.

Piece No.	Name	No. Required					
		906-S	1006-S	1105-S	1106	1106-S	1108-S
5486	Gasoline tank inlet cap assembly-right screw #10-32 x 1-1/8" fill. hd. (Use with body 275) .....	-	-	-	-	2	-
5500	Lockwasher #10 (Use with body 275) .....	-	-	-	-	2	-
216632	Gasoline tank inlet cap emblem (Use with body 275) .....	-	-	-	-	2	-
219599	Gasoline tank inlet cap emblem retaining nut (Use with body 275) .....	-	-	-	-	2	-
219613	Gasoline tank inlet cap locking plate assembly (Use with body 275) .....	-	-	-	-	1	-
8208	Screw #10-32 x 3/8" flat hd. (Use with body 275) .....	-	-	-	-	4	-
219611	Gasoline tank inlet cap-right spacer (Use with body 275) ....	-	-	-	-	2	-
219601	Gasoline tank inlet flange-right (Use with body 275) .....	-	-	-	-	1	-
219600	Gasoline tank inlet flange-left (Use with body 275) .....	-	-	-	1	-	-
7729	Screw #10-32 x 1 1/32" fill. hd. (Use with body 275) .....	-	-	-	8	-	-
5500	Lockwasher #10 (Use with body 275) .....	-	-	-	8	-	-
219624	Gasoline tank inlet flange gasket (Use with body 275) .....	-	-	-	2	-	-
219418	Gasoline tank inlet tube assembly (Use with body 280) .....	-	-	1	-	-	1
210258	Gasoline tank support bracket reinforcement-front (Use with body 275) .....	-	-	-	-	1	-
216652	Gasoline tube outer assembly .....	-	-	-	1	-	-

### INSTRUMENT BOARD

210788	Instrument board brake vacuum control valve universal joint drive shaft (Use with bodies 275-280-4069) .....	-	-	1	-	1	1
219840	Instrument board brake vacuum control valve universal joint drive shaft (Use with bodies 4068-70-71-72-4182) ....	-	-	-	-	-	1
210788	Instrument board brake vacuum control valve universal joint drive shaft .....	-	1	-	-	-	-
213869	Instrument board motor thermometer .....	-	-	-	-	1	1
216966	Instrument board motor thermometer (Use with body 280) .....	-	-	1	-	-	-
210796	Instrument board motor thermometer .....	-	-	-	-	1	-
210832	Instrument board oil pressure gauge tube upper assembly .....	-	1	1	-	1	1
215004	Instrument board plate and instruments assembly .....	-	1	-	-	-	-
213896	Instrument board plate and instruments assembly .....	-	-	-	-	1	1
216965	Instrument board plate and instruments assembly (Use with body 280) .....	-	-	1	-	-	-
210797	Instrument board speedometer driving shaft (Waltham) .....	-	1	1	-	1	1
205708	Instrument board speedometer driving shaft cable (Waltham) ..	-	1	1	-	1	1
210712	Instrument board steering post bracket support (Use with bodies 3068-69-70-71-72-3182-4069, .....	-	1	-	-	-	1
219839	Instrument board steering post bracket support (Use with bodies 4068-70-71-72-4182) .....	-	-	-	-	-	1

### LAMP

219711	Lamp front assembly-right (Use with body 280) .....	-	-	1	-	-	-
219513	Lamp front assembly-right (Use with bodies 275-280) .....	-	-	-	-	1	1
219710	Lamp front assembly-left (Use with body 280) .....	-	-	1	-	-	-
219512	Lamp front assembly-left (Use with bodies 275-280) .....	-	-	-	-	1	1
219632	Lamp rear and bracket assembly-right (Use with body 275) ....	-	-	-	-	1	-
219631	Lamp rear and bracket assembly-left (Use with body 275) .....	-	-	-	-	1	-
219619	Lamp rear bracket-right (Use with body 275) .....	-	-	-	-	1	-
219618	Lamp rear bracket-left (Use with body 275) .....	-	-	-	-	1	-
8003	Lamp rear bracket to body screw (Use with body 275) .....	-	-	-	-	4	-
6070	Lamp rear cracket to body screw lock washer (Use with body 275) .....	-	-	-	-	4	-
219627	Lamp rear bracket gasket (Use with body 275) .....	-	-	-	-	2	-

### MOTOR

215909	Motor carburetor silencer and air cleaner support (Use with body 280) .....	-	-	1	-	-	-
--------	--	---	---	---	---	---	---

\* For items not listed herein see instructions on Page 2.

SERVICE PARTS LIST

Radiator 7

Piece No.	Name	No. Required					
		906-S	1006-S	1105-S	1106	1106-S	1108-S
219011	Motor cylinder head and core hole plug assembly right (Use with bodies 275-280) .....	-	-	-	-	1	1
219010	Motor cylinder head and core hole plug assembly left (Use with bodies 275-280) .....	-	-	-	-	1	1
216849	Motor cylinder head gasket (Use with bodies 275-280) .....	-	-	-	-	2	2
6308	Motor cylinder head stud-short (Use with bodies 275-280) ....	-	-	-	-	14	14
213902	Motor cylinder head stud washer (Use with bodies 275-280) ...	-	-	-	-	36	36
207731	Motor distributor (Use with bodies 275-280) .....	-	-	-	-	1	1
219474	Motor ignition coil cable conduit to instrument board clip (Use with bodies 4068-69-70-71-72-4182) .....	-	-	-	-	-	1
215540	Motor ignition coil cable and switch assembly .....	-	-	-	-	1	1
216967	Motor ignition coil cable and switch assembly (Use with body 280) .....	-	-	1	-	-	-
210851	Motor ignition coil and switch assembly (with key) .....	-	1	-	-	-	-
209190	Motor support front assembly-left (Use with bodies 3068- 3182-4068-4182) .....	-	1	-	-	-	1
209246	Motor support front assembly-left (Use with bodies 3069- 70-71-72-275-280-4069-70-71-72) .....	-	1	-	-	1	1
209191	Motor support front assembly-right (Use with bodies 3068- 3182-4068-4182) .....	-	1	-	-	-	1
209247	Motor support front assembly-right (Use with bodies 3069- 70-71-72-275-280-4069-70-71-72) .....	-	1	-	-	1	1

RADIATOR

205604	Radiator bonnet ledge liner .....	-	-	-	2	-	-
201861	Radiator bonnet ledge liner (Use with body 4069) .....	-	-	-	-	-	2
205604	Radiator bonnet ledge liner (Use with bodies 275-280-4068-70-71-72-4182) .....	-	-	2	-	2	2
207535	Radiator core and anchorage assembly (Use with body 280) ....	-	-	1	-	-	-
205645	Radiator core and anchorage assembly (Use with bodies 275-280-4068-4070-71-72-4182) .....	-	-	-	-	1	1
207530	Radiator core and anchorage assembly (Use with body 4069) ...	-	-	-	-	-	1
205645	Radiator core and anchorage assembly .....	-	-	-	1	-	-
194893	Radiator core to shell liner-side upper (Use with body 4069) .....	-	-	-	-	-	2
205655	Radiator core to shell liner-side upper (Use with bodies 275-280-4068-70-71-72-4182) .....	-	-	2	-	2	2
205655	Radiator core to shell liner-side upper .....	-	-	-	2	-	-
209120	Radiator to dash tie rod (Use with body 280) .....	-	-	2	-	-	-
209161	Radiator to dash tie rod (Use with bodies 3069-4069) .....	-	2	-	-	-	2
209113	Radiator to dash tie rod (Use with bodies 275-280-4182- 3068-70-71-72-4068-70-71-72) .....	-	2	-	-	2	2
209113	Radiator to dash tie rod .....	-	-	-	2	-	-
197591	Radiator to dash tie rod washer (Use with bodies 4068-69-70-71-72) .....	-	-	-	-	-	2
197591	Radiator to dash tie rod washer (Use with bodies 275-280-4182) .....	-	-	4	-	4	4
190960	Radiator to dash tie rod washer (Use with bodies 4068-69-70-71-72) .....	-	-	-	-	-	2
197591	Radiator to dash tie rod washer .....	-	-	-	4	-	-
209785	Radiator fan shroud assembly (Use with body 4069) .....	-	-	-	-	-	1
209786	Radiator fan shroud assembly (Use with bodies 275-280-4068-70-71-72-4182) .....	-	-	1	-	1	1
209786	Radiator fan shroud assembly .....	-	-	-	1	-	-
207615	Radiator hose-inlet (Use with body 280) .....	-	-	1	-	-	-
205679	Radiator hose-inlet short (Use with bodies 275-280-4068-70-71-72-4182) .....	-	-	-	-	1	1
205679	Radiator hose-inlet short .....	-	-	-	1	-	-
201121	Radiator hose-inlet short (Use with body 4069) .....	-	-	-	-	-	1
205680	Radiator hose-inlet long (Use with bodies 275-280-4068-70-71-72-4182) .....	-	-	-	-	1	1

\* For items not listed herein see instructions on Page 2.

Piece No.	Name	No. Required					
		906-S	1006-S	1105-S	1106	1106-S	1108-S
201122	Radiator hose-inlet long (Use with body 4069) .....	-	-	-	-	-	1
205680	Radiator hose-inlet long .....	-	-	-	1	1	-
209499	Radiator shell assembly (Painted) (Use with body 4069) .....	-	-	-	-	-	1
205625	Radiator shell assembly (Painted) (Use with bodies 275-280-4068-70-71-72-4182) .....	-	-	1	-	1	1
205625	Radiator shell assembly (Painted) .....	-	-	-	1	-	-
205626	Radiator shell assembly (Chromium) (Use with bodies 275-280-4068-70-71-72-4182) .....	-	-	1	-	1	1
205626	Radiator shell assembly (Chromium) .....	-	-	-	1	-	-
209505	Radiator shell assembly (Chromium) (Use with body 4069) .....	-	-	-	-	-	1
213138	Radiator shell to radiator core liner (Use with body 4069) ..	-	-	-	-	-	2
213137	Radiator shell to radiator core liner (Use with bodies 275-280-4068-4070-71-72-4182) .....	-	-	2	-	2	2
213137	Radiator shell to radiator core liner .....	-	-	-	2	-	-
210376	Radiator shutter assembly (Chrome) (Use with body 280) .....	-	-	1	-	-	-
207717	Radiator shutter assembly (Black enamel) (Use with body 280) .....	-	-	1	-	-	-
207728	Radiator shutter assembly (Specify color) (Use with body 280) .....	-	-	1	-	-	-
201246	Radiator shutter assembly (Chrome) (Use with body 4069) .....	-	-	-	-	-	1
205799	Radiator shutter assembly (Chrome) (Use with bodies 275-280-4068-70-71-72-4182) .....	-	-	-	-	1	1
205799	Radiator shutter assembly (Chrome) .....	-	-	-	1	-	-
203458	Radiator shutter assembly (Specify color) (Use with body 4069) .....	-	-	-	-	-	1
205800	Radiator shutter assembly (Specify color) (Use with bodies 275-280-4068-70-71-72-4182) .....	-	-	-	-	1	1
205800	Radiator shutter assembly (Specify color) .....	-	-	-	1	-	-

**REAR AXLE**

7853	Rear axle brake support plate screw 3/8-24 x 1-1/8" hex. hd. ....	-	-	-	16	-	-
7006	Nut 3/8-24 .....	-	-	-	16	-	-
5506	Lockwasher .....	-	-	-	16	-	-
207947	Rear axle case assembly .....	-	-	-	1	-	-
207920	Rear axle shaft-left .....	-	-	-	1	-	-
207921	Rear axle shaft-right .....	-	-	-	1	-	-
176592	Rear axle shaft bearing assembly .....	-	-	-	4	-	-
197130	Rear axle shaft key .....	-	-	-	2	-	-
197143	Rear axle shaft nut .....	-	-	-	2	-	-
6024	Cotter pin 3/16 x 1-3/8" .....	-	-	-	2	-	-
126985	Rear axle shaft washer .....	-	-	-	2	-	-
207433	Rear axle shaft bearing oil guard .....	-	-	-	2	-	-
170290	Rear axle shaft bearing oil seal-inner .....	-	-	-	2	-	-
210140	Rear axle shaft bearing oil seal-outer .....	-	-	-	2	-	-
207425	Rear axle shaft bearing oil seal retainer gasket .....	-	-	-	6	-	-
207428	Rear axle shaft bearing shim .005 .....	-	-	-	x	-	-
207430	Rear axle shaft bearing shim .018 .....	-	-	-	x	-	-
207427	Rear axle shaft bearing shim .003 .....	-	-	-	x	-	-

**RUNNING BOARD**

**Running Boards for Bodies 275-280  
Special—Le Baron**

215754	Running board left assembly .....	-	-	-	1	-	-
215755	Running board right assembly .....	-	-	-	1	-	-
4175	Running board bracket rivet 5/16 x 7/8" rnd hd. ....	-	-	-	24	-	-
215633	Running board and mat assembly-right .....	-	-	-	1	-	-
215632	Running board and mat assembly-left .....	-	-	-	1	-	-
207360	Running board moulding-inboard-left .....	-	-	-	1	-	-
207361	Running board moulding-inboard-right .....	-	-	-	1	-	-

\* For items not listed herein see instructions on Page 2.



## SERVICE PARTS LIST

Splasher 9

Piece No.	Name	No. Required					
		906-S	1006-S	1105-S	1106	1106-S	1108-S
215804	Running board moulding-outboard .....	-	-	-	2	-	-
215793	Running board trim strip front left assembly .....	-	-	-	1	-	-
215794	Running board trim strip front right assembly .....	-	-	-	1	-	-
215822	Running board trim strip rear left assembly .....	-	-	-	1	-	-
215823	Running board trim strip rear right assembly .....	-	-	-	1	-	-
215839	Running board trim strip side left .....	-	-	-	1	-	-
215838	Running board trim strip side right .....	-	-	-	1	-	-
215736	Running board trim strip screw .....	-	-	-	32	-	-
5695	Lockwasher .....	-	-	-	32	-	-
7002	Nut #8-32 plain .....	-	-	-	32	-	-

## SHOCK ABSORBER

209759	Shock absorber control connecting rod rear assembly .....	-	-	-	2	-	-
210821	Shock absorber control operating rod assembly .....	-	2	2	-	2	2
210853	Shock absorber control operating rod support assembly .....	-	1	1	-	1	1
210852	Shock absorber control operating rod support tube and bracket assembly .....	-	1	1	-	1	1

## SPLASHER

207678	Splasher frame to crankcase-front .....	-	-	-	1	-	-
207679	Splasher frame to crankcase-left assembly .....	-	-	-	1	-	-
207689	Splasher frame to crankcase-right assembly .....	-	-	-	1	-	-
210468	Splasher frame to crankcase brace-right .....	-	-	-	1	-	-
7824	Screw 1/4-28 x 5/8" hex. hd. ....	-	-	-	3	-	-
215993	Splasher frame to crankcase front liner-side .....	-	-	-	2	-	-
215624	Splasher frame rear end assembly .....	-	-	-	1	-	-
215620	Splasher frame rear end assembly .....	-	-	-	1	-	-
215620	Splasher frame rear end assembly (Used with bodies 4068-9-70-71) (Rear carrier) .....	-	-	-	-	-	1
215623	Splasher frame rear end assembly (Used with bodies 4068-69-70-71) (Side carrier) .....	-	-	-	-	-	1
219521	Splasher frame rear end assembly (Use with body 280) .....	-	-	1	-	-	1
215681	Splasher frame rear end assembly (Use with bodies 4182-4072) (Rear wheel carrier) .....	-	-	-	-	-	1
219555	Splasher frame rear end assembly (Use with body 275) (Not used with wheel carrier) .....	-	-	-	-	1	-
213956	Splasher frame rear end assembly (Use with body 3182) (Rear wheel carrier) .....	-	1	-	-	-	-
219655	Splasher frame rear end assembly (Use with body 275 with wheel carrier) .....	-	-	-	-	-	1
215656	Splasher frame rear end assembly (Use with body 4182) (Side carrier) .....	-	-	-	-	-	1
213999	Splasher frame rear end assembly (Use with body 3182) (Side carrier) .....	-	1	-	-	-	-
215622	Splasher frame rear end assembly (Use with body 4072) (Side carrier) .....	-	-	-	-	-	1

## SPLASHER - SIDE FOR BODIES 275-280

## Special Le Baron

209368	Splasher-side-left (Side carrier) .....	-	-	-	1	-	-
207366	Splasher-side-left (Rear carrier) .....	-	-	-	1	-	-
213997	Splasher-side-left (Use with body 3182-4182) .....	-	1	-	-	-	1
210866	Splasher side-left (Use with bodies 3068-9-70- 3071-72-4068-9-70-71-72) .....	-	1	-	-	-	1
209369	Splasher-side right (Side carrier) .....	-	-	-	1	-	-
207367	Splasher-side right (Rear carrier) .....	-	-	-	1	-	-
213998	Splasher-side right (Use with body 3182-4182) .....	-	1	-	-	-	1
210867	Splasher-side right (Use with bodies 3068-9-70- 3071-72-4068-9-70-71-72) .....	-	1	-	-	-	1

\* For items not listed herein see instructions on Page 2.

Piece No.	Name	No. Required					
		906-S	1006-S	1105-S	1106	1106-S	1108-S
209712	Splasher side to running board and front fender liner .....	-	-	-	2	-	-
213228	Splasher side to frame bracket .....	-	6	-	-	-	6
5460	Splasher side to frame bracket to frame bolt #10- 32 x 3/4 fill. hd. ....	-	12	-	-	-	12
7003	Nut #10-32 .....	-	12	-	-	-	12
5500	Lockwasher #10 .....	-	12	-	-	-	12
3867	Washer 3/16" .....	-	24	-	-	-	24
3874	Splasher side to frame washer 5/16" .....	-	2	-	-	-	2
5568	Splasher side to splasher side frame bracket bolt 1/4-28 x 5/8 fill. hd. ....	-	6	-	-	-	6
7004	Nut 1/4-28 .....	-	6	-	-	-	6
5502	Lockwasher 1/4" .....	-	6	-	-	-	6
62065	Washer 17/64 x 3/4" .....	-	6	-	-	-	6

### SPRING

180388	Spring rear and cover assembly (Use with bodies 3068-3071-4071-275) .....	-	2	-	-	2	2
180388	Spring rear and cover assembly .....	-	-	-	2	-	-
180396	Spring rear and cover assembly (Use with body 4068) .....	-	-	-	-	-	2
180398	Spring rear and cover assembly (Use with bodies 4070-72-4182) .....	-	-	-	-	-	2
180390	Spring rear and cover assembly (Use with bodies 3069-70-72-3182-280-4069) .....	-	2	2	-	-	2
6269	Spring rear rubber bumper bracket screw 3/8-24 x 2-1/4" hex. hd. (Use with bodies 3069-3070-4069-4070) .....	-	2	-	-	-	2
7822	Spring rear rubber bumper bracket screw 3/8-24 x 1-1/2" hex. hd. ....	-	-	-	4	-	-
213833	Spring rear rubber bumper bracket spacer (Use with bodies 3069-3070-4069-70) .....	-	2	-	-	-	2

### STEERING CONNECTING ROD

210345	Steering connecting rod assembly (Use with body 275) .....	-	-	-	-	1	-
--------	--	---	---	---	---	---	---

### STEERING GEAR - PACKARD

(Prior to Steering Unit No. 900581)

203947	Steering gear assembly .....	1	-	-	-	-	-
194940	Steering pillar tube assembly .....	1	-	-	-	-	-
194943	Steering post control cover support and tube assembly .....	1	-	-	-	-	-
197984	Steering post to instrument board bracket and cap assembly ..	1	-	-	-	-	-
203948	Steering post clutch control shaft assembly .....	1	-	-	-	-	-
203949	Steering post lighting switch control shaft assembly .....	1	-	-	-	-	-
194956	Steering post to toe board grommet .....	1	-	-	-	-	-
194955	Steering worm and post assembly .....	1	-	-	-	-	-

### STEERING GEAR - GEMMER

(After Steering Unit No. 900580)

209911	Steering gear assembly (38-5/8" long from top of case to bottom of steering wheel hub) .....	1	-	-	-	-	-
213241	Steering gear assembly (38-5/8" long from top of case to bottom of steering wheel hub) .....	-	1	-	-	-	-
215956	Steering gear assembly (38-25/32" long from top of adjusting nut to bottom of steering wheel hub) .....	-	-	-	-	-	1
216658	Steering gear assembly (39-9/32" long from top of adjusting nut to bottom of steering wheel hub) .....	-	-	1	-	1	1
215927	Steering gear cross shaft lever .....	-	-	1	-	-	-
216101	Steering gear lighting switch base assembly .....	-	-	1	-	-	-
7003	Steering gear lighting switch base retaining nut .....	-	-	2	-	-	-
3866	Steering gear lighting switch base retaining washer .....	-	-	2	-	-	-

\* For items not listed herein see instructions on Page 2.



SERVICE PARTS LIST

Trunk 11

Piece No.	Name	No. Required					
		906-S	1006-S	1105-S	1106	1106-S	1108-S
209536	Steering pillar tube assembly (39-5/8" long) .....	1	1	-	-	-	-
213288	Steering pillar tube assembly (40-1/8" long) .....	-	1	-	-	-	-
215510	Steering pillar tube assembly (42-11/32" long) .....	-	-	-	-	-	1
216605	Steering pillar tube assembly (42-27/32" long) .....	-	-	1	-	1	1
203996	Steering post control cover assembly .....	-	-	1	-	-	-
194943	Steering post control cover support and tube assembly (50-7/64" long overall) .....	1	1	-	-	-	-
210914	Steering post control cover support and tube assembly (50-39/64" long overall) .....	-	1	-	-	-	1
216608	Steering post control cover support and tube assembly (51-7/64" long overall) .....	-	-	1	-	1	1
203780	Steering post horn button and contact assembly .....	-	-	1	-	-	-
215954	Steering post horn button cable assembly .....	-	-	1	-	1	1
197984	Steering post to instrument board bracket and cap assembly ..	1	1	1	-	1	1
210053	Steering post to instrument board bracket screw plate .....	-	-	1	-	-	-
203949	Steering post lighting switch control shaft assembly (51-7/8" long) .....	1	1	-	-	-	-
216633	Steering post lighting switch control shaft assembly (52-7/8" long) .....	-	-	1	-	1	1
210918	Steering post lighting switch control shaft assembly (52-3/8" long) .....	-	1	-	-	-	1
203948	Steering post clutch control shaft assembly (50-19/32" long)	1	-	-	-	-	-
203948	Steering post throttle control shaft assembly (50-19/32" long) .....	-	1	-	-	-	-
210916	Steering post throttle control shaft assembly (51-9/32" long) .....	-	1	-	-	-	1
216635	Steering post throttle control shaft assembly (51-25/32" long) .....	-	-	1	-	1	1
194956	Steering post to toe board grommet .....	1	1	1	-	1	1
203781	Steering wheel assembly .....	-	-	1	-	-	-
98275	Steering worm and post assembly (47-19/32" long) .....	1	1	-	-	-	-
216608	Steering worm and post assembly (48-3/32" long) .....	-	1	-	-	-	1
216659	Steering worm and post assembly (48-19/32" long) .....	-	-	1	-	1	1

TOE BOARD

219202	Toe board insulation and liners assembly .....	-	-	1	-	-	-
219201	Toe board insulation and liners assembly .....	-	-	-	-	1	1

TOOLS

210404	Tool box tire pump (Use with body 275) .....	-	-	-	-	1	-
--------	--	---	---	---	---	---	---

TRANSMISSION

210710	Transmission change speed lever .....	-	1	1	-	1	1
210820	Transmission change speed lever extension .....	-	1	1	-	1	1
175442	Transmission speedometer pinion and shaft (4.41 to 1 ratio) .	-	-	-	1	-	-
175441	Transmission speedometer pinion shaft bearing (4.41 to 1 ratio) .....	-	-	-	1	-	-

TRUNK

210311	Trunk rack assembly .....	-	-	-	1	-	-
216816	Trunk rack assembly (Use with bodies 4068-69-70-4071-4182) ..	-	-	-	-	-	1
216812	Trunk rack assembly (Use with body 4072) .....	-	-	-	-	-	1
182308	Trunk rack brace joint assembly (Use with body 4072) .....	-	-	-	-	-	2
194251	Trunk rack brace joint assembly (Use with bodies 4068-69-70-71-4182) .....	-	-	-	-	-	2
182308	Trunk rack brace joint assembly .....	-	-	-	2	-	-
215658	Trunk rack and trunk rack frame bracket assembly (Use with body 4072) .....	-	-	-	-	-	1

\* For items not listed herein see instructions on Page 2.

Piece No.	Name	No. Required					
		906-S	1006-S	1105-S	1106	1106-S	1108-S
216689	Trunk rack and trunk rack frame bracket assembly .....	-	-	-	1	-	-
205685	Trunk rack and trunk rack frame bracket assembly (Use with bodies 4068-69-70-71) .....	-	-	-	-	-	1
216219	Trunk rack and trunk rack frame bracket assembly (Use with body 4182) .....	-	-	-	-	-	1
215574	Trunk rack frame bracket assembly-left (Use with body 4072) .	-	-	-	-	-	1
215574	Trunk rack frame bracket assembly-left .....	-	-	-	1	-	-
205614	Trunk rack frame bracket assembly-left (Use with bodies 4068-69-70-71) .....	-	-	-	-	-	1
213960	Trunk rack frame bracket assembly-left (Use with body 3182-4182) .....	-	1	-	-	-	1
215573	Trunk rack frame bracket assembly-right (Use with body 4072)	-	-	-	-	-	1
215573	Trunk rack frame bracket assembly-right .....	-	-	-	1	-	-
205616	Trunk rack frame bracket assembly-right (Use with bodies 4068-9-70-71) .....	-	-	-	-	-	1
213961	Trunk rack frame bracket assembly-right (Use with body 3182-4182) .....	-	1	-	-	-	1
5929	Trunk rack frame bracket bolt-screw 7/16-20 x 1-5/8" hex. hd. (Use with body 3182-4182) .....	-	2	-	-	-	2
141987	Nut 7/16-20 blind (Use with body 3182-4182) .....	-	2	-	-	-	2
5508	Lockwasher 7/16" (Use with body 3182-4182) .....	-	2	-	-	-	2
3883	Washer 7/16" (Use with body 3182-4182) .....	-	2	-	-	-	2

### UNIVERSAL JOINT

221129	Universal joint shaft and flange assembly ....	-	-	-	1	-	-
219984	Universal joint shaft .....	-	-	-	1	-	-

### WHEELS

209744	Wheel assembly (Wood) .....	-	-	-	5	-	-
205111	Wheel assembly (Wire) .....	-	-	-	5	-	-
205112	Wheel assembly (Chromium) (Wire) .....	-	-	-	5	-	-
213820	Wheel balance weight .....	-	-	-	10	-	-
219576	Wheel balance weight set screw 1/4-20 x 1/2 Sq. hd. cup point .....	-	-	-	10	-	-
216894	Wheel hub cap front (Wire) .....	-	-	-	2	-	-
216897	Wheel hub and drum assembly-front .....	-	-	-	2	-	-
216628	Wheel hub shell cover and emblem assembly (Specify color) ...	-	-	-	5	-	-
216632	Wheel hub shell cover emblem .....	-	-	-	5	-	-
203387	Wheel spoke-inner .....	-	-	-	x	-	-
203385	Wheel spoke-outer .....	-	-	-	x	-	-
203389	Wheel spoke-nipple .....	-	-	-	x	-	-
219732	Wheel trim ring .....	-	-	-	5	4	-

### WHEEL CARRIER

205605	Rear wheel carrier bracket brace .....	-	-	-	1	-	-
205605	Rear wheel carrier bracket brace (Use with body 4072) .....	-	-	-	-	-	1
207327	Rear wheel carrier bracket brace (Use with body 4068) .....	-	-	-	-	-	1
213951	Rear wheel carrier bracket brace (Use with body 3182-4182) ..	-	1	-	-	-	1
7010	Rear wheel carrier bracket brace nut (Use with body 3182-4182) .....	-	2	-	-	-	2
213952	Rear wheel carrier bracket brace to body grommet (Use with body 3182-4182) .....	-	1	-	-	-	1
213950	Rear wheel carrier bracket and dowel assembly (Use with body 3182-4182) .....	-	1	-	-	-	1
207382	Rear wheel carrier bracket and dowel assembly (Use with body 4068-9-70-71) .....	-	-	-	-	-	1
219389	Rear wheel carrier bracket and dowel assembly (Use with body 275) .....	-	-	-	-	1	-

\* For items not listed herein see instructions on Page 2.

SERVICE PARTS LIST

Piece No.	Name	No. Required				
		906-S	1006-S	1105-S	1106	1106-S 1108-S
213953	Rear wheel carrier bracket liner (Use with body 3182-4182) ..	-	1	-	-	1
219421	Rear wheel carrier bracket liner-lower (Use with body 275) ..	-	-	-	-	1
219420	Rear wheel carrier bracket liner-upper (Use with body 275) ..	-	-	-	-	1
205630	Rear wheel carrier bracket and support plate assembly .....	-	-	-	1	-
205631	Rear wheel carrier bracket and support plate assembly (Use with body 4072) .....	-	-	-	-	1
219414	Rear wheel carrier bracket support (Use with body 275) .....	-	-	-	-	1
213954	Rear wheel carrier bracket support (Use with body 3182-4182)	-	1	-	-	1
6037	Bolt 1/2-20 x 1-3/16" hex. hd. (Use with body 275) .....	-	-	-	-	2
7885	Screw 7/16-20 x 1-3/8" hex. hd. (Use with body 3182-4182)	-	2	-	-	2
5508	Lockwasher 7/16" (Use with body 3182-4182) .....	-	2	-	-	2
7008	Nut 1/2-20 (Use with body 275) .....	-	-	-	-	2
5510	Lockwasher 1/2" (Use with body 275) .....	-	-	-	-	2
7819	Rear wheel carrier bracket support to frame screw 3/8-24 x 1" hex. hd. (Use with body 3182-4182) .....	-	3	-	-	3
7006	Nut 3/8-24 (Use with body 3182-4182) .....	-	3	-	-	3
5506	Lockwasher 3/8" (Use with body 3182-4182) .....	-	3	-	-	3
219422	Rear wheel carrier bracket support liner (Use with body 275)	-	-	-	-	1
216353	Side wheel carrier brace assembly (Use with bodies 4068-70-71-72-4182) .....	-	-	-	-	2
124383	Side wheel carrier brace lock washer (Use with bodies 4068-70-71-72-4182) .....	-	-	-	-	2
216344	Side wheel carrier brace nut (Use with bodies 4068-70-71-72-4182) .....	-	-	-	-	4
216323	Side wheel carrier brace to body stud (Use with bodies 4068-70-71-72-4182) .....	-	-	-	-	2
5518	Lockwasher 3/4" (Use with bodies 4068-70-4071-72-4182) ..	-	-	-	-	2
7012	Nut 3/4-16 (Use with bodies 4068-70-71-72-4182) .....	-	-	-	-	2
216354	Nut (Use with bodies 4068-70-71-72-4182) .....	-	-	-	-	2
216324	Side wheel carrier brace to body stud grommet (Use with bodies 4068-70-71-72-4182) .....	-	-	-	-	2
216329	Side wheel carrier brace to front fender grommet-right (Use with bodies 4068-70-71-72-4182) .....	-	-	-	-	1
216366	Side wheel carrier brace to front fender grommet-left (Use with bodies 4068-70-71-72-4182) .....	-	-	-	-	1
209254	Side wheel carrier bracket left assembly .....	-	-	-	1	-
209255	Side wheel carrier bracket right assembly .....	-	-	-	1	-
209239	Side wheel carrier bracket brace-left .....	-	-	-	1	-
209240	Side wheel carrier bracket brace-right .....	-	-	-	1	-
216355	Side wheel carrier frame bracket-right (Use with bodies 4068-70-71-72-4182) .....	-	-	-	-	1
216356	Side wheel carrier frame bracket-left (Use with bodies 4068-70-71-72-4182) .....	-	-	-	-	1
5575	Screw 5/16-24 x 7/8" hex. hd. (Use with bodies 4068-70-71-72-4182) .....	-	-	-	-	6
5753	Screw 5/16-24 x 1-7/8" hex. hd. (Use with bodies 4068-70-71-72-4182) .....	-	-	-	-	2
5504	Lockwasher 5/16" (Use with bodies 4068-70-71-4072-4182) .	-	-	-	-	8
7005	Nut 5/16-24 (Use with bodies 4068-70-71-72-4182) .....	-	-	-	-	8
216361	Side wheel carrier frame bracket to wheel well liner (Use with bodies 4068-70-1-2-4182) .....	-	-	-	-	2
7600	Bolt 5/16-24 x 7/8 carriage (Use with bodies 4068-70-71-72-4182) .....	-	-	-	-	8
5504	Lockwasher 5/16" (Use with bodies 4068-70-4071-4072-4182)	-	-	-	-	8
7005	Nut 5/16-24 (Use with bodies 4068-70-71-72-4182) .....	-	-	-	-	8
221130	Side wheel carrier lock hub and cap assembly (Use with bodies 4068-70-71-72-4182) .....	-	-	-	-	2
216343	Side wheel carrier lock plate (Use with bodies 4068-70-71-72-4182) .....	-	-	-	-	2
216359	Side wheel carrier tire clamp and cushion assembly (Use with bodies 4068-70-71-72-4182) .....	-	-	-	-	2

\* For items not listed herein see instructions on Page 2.

## 14 Wheel Carrier

## SERVICE PARTS LIST

Piece No.	Name	No. Required					
		906-S	1006-S	1105-S	1106	1106-S	1108-S
216362	Side wheel carrier tire clamp cushion (Use with bodies 4068-70-71-72-4182) .....	-	-	-	-	-	2
216321	Side wheel carrier tire clamp nut (Use with bodies 4068-70-71-72-4182) (Use only with Firestone tire) .....	-	-	-	-	-	2
219054	Side wheel carrier tire clamp nut (Use with bodies 4068-70-71-72-4182) (Not used with Firestone tires) .....	-	-	-	-	-	2
216325	Side wheel carrier tire cushion (Use with bodies 4068-70-71-72-4182) .....	-	-	-	-	-	4
7612	Bolt 1/4-28 x 3/4 Carriage (Use with bodies 4068-70-71-72-4182).....	-	-	-	-	-	12
62065	Washer 1/4" special (Use with bodies 4068-70-71-72-4182)	-	-	-	-	-	12
7004	Nut 1/4-28 (Use with bodies 4068-70-71-72-4182) .....	-	-	-	-	-	12

\* For items not listed herein see instructions on Page 2.

SERVICE PARTS LIST

Body Parts 15

Piece No.	Name	No. Required					
		3068 4068	3069 4069	3070 4070	3071 4071	3072 4072	3182 4182
<b>BODY PARTS</b>							
Note: Body Parts Not Listed Are Furnished By Body Builder.							
199771	Body to frame bolt #1 carriage bolt 7/16-20 x 3-5/8" skew head .....	2	2	2	2	2	2
5282	Body to frame bolt #2 Screw 7/16-20 x 3-1/2" hex. hd. mach. .	2	2	2	2	2	2
5282	Body to frame bolt #3 Screw 7/16-20 x 3-1/2" hex. hd. mach. .	2	2	-	2	2	-
5281	Body to frame bolt #3 Screw 7/16-20 x 3-7/8" hex. hd. mach. .	-	-	2	-	-	2
6283	Body to frame bolt #4 Screw 7/16-20 x 3-11/16" flat hd. mach.	-	-	x	-	-	x
5968	Body to frame bolt #4 Screw 7/16-20 x 4" flat hd. ....	-	-	x	-	-	x
5282	Body to frame bolt #4 Screw 7/16-20 x 3-1/2" hex. hd. mach. .	2	2	-	2	2	-
5671	Body to frame bolt #5 Screw 7/16-20 x 5-3/8" hex. hd. mach. .	-	-	2	-	-	-
5970	Body to frame bolt #5 Screw 7/16-20 x 5" hex. hd. mach. ....	-	-	-	-	-	2
187285	Body to frame bolt #5 Carriage bolt 7/16-20 x 7-3/16" skew head .....	2	2	-	2	2	-
131809	Body to frame bolt washer-large 7/16" special .....	6	6	2	6	6	2
131046	Body to frame bolt washer-small 7/16" special .....	10	10	12	10	10	12
5508	Body to frame bolt lock washer 7/16" .....	6	6	8	6	6	8
5806	Body to frame bolt lock washer .....	4	4	2	4	4	2
7007	Body to frame bolt nut 7/16-20 .....	10	10	8	10	10	8
182439	Body to frame bolt nut lock .....	4	4	4	4	4	4
199770	Body to frame bolt plate .....	2	2	2	2	2	2
206192	Body to frame liner 3/16" thick .....	x	x	x	x	x	x
193931	Body to frame liner 3/16" thick .....	x	x	x	x	x	x
185273	Body to frame liner 3/16" thick .....	x	x	-	x	x	-
206193	Body to frame liner 1/4" thick .....	x	x	x	x	x	x
206194	Body to frame liner 5/16" thick .....	x	x	x	x	x	x
167924	Body to frame liner hand brake lever insulator .....	1	1	1	1	1	1
185270	Body hold down bolt bracket liner 3/8" thick .....	x	x	x	x	x	x
185274	Body hold down bolt bracket liner 1/2" thick .....	x	x	x	x	x	x
185273	Body hold down bolt bracket liner 3/16" thick .....	x	x	x	x	x	x
133104	Body hold down bolt bracket liner 1/32" thick .....	x	x	x	x	x	x
206652	Bonnet dash liner ....	2	2	2	2	2	2
187260	Bonnet dash liner hook .....	2	2	2	2	2	2
3866	Washer 3/16" plain .....	2	2	2	2	2	2
7002	Nut #8-32 .....	2	2	2	2	2	2
206476	Floor board front assembly .....	-	1	1	-	-	1
206478	Floor board front assembly .....	1	-	-	1	1	-
185832	Floor board front assembly washer .....	4	4	4	4	4	4
206481	Floor board front felt-front .....	1	1	1	1	1	1
206840	Floor board front felt-center .....	1	1	1	1	1	1
206479	Floor board front felt-rear .....	1	1	1	1	1	1
206482	Floor board front felt-side .....	-	2	2	-	-	2
206484	Floor board front felt-side .....	2	-	-	2	2	-
206503	Panel dash cover assembly (Use with bodies 3068-69-70-71-72)	1	1	1	1	1	-
212997	Panel dash cover assembly (Use with bodies 4068-9-70-71-72-4182) .....	1	1	1	1	1	1
204679	Panel dash cover assembly (Use with body 3182) .....	-	-	-	-	-	1
7800	Panel dash cover attaching screw 1/4-28 x 1" hex. hd. mach. .	2	2	2	2	2	2
62065	Washer 1/4" .....	2	2	2	2	2	2
5502	Lockwasher 1/4" .....	2	2	2	2	2	2
212878	Panel dash inter-liner (Use with bodies 4068-69-70-71-72-4182) .....	1	1	1	1	1	1
204681	Panel dash inter-liner (Use with body 3182) .....	-	-	-	-	-	1

\* For items not listed herein see instructions on Page 2.

## 16 Body Parts

## SERVICE PARTS LIST

Piece No.	Name	No. Required					
		3068 4068	3069 4069	3070 4070	3071 4071	3072 4072	3182 4182
206492	Panel dash inter-liner (Use with bodies 3068-69-70-71-72) ...	1	1	1	1	1	-
214770	Rumble seat step lower assembly (Use with bodies 4068-4071) (Rear wheel carrier) .....	1	-	-	1	-	-
206514	Rumble seat step lower assembly (Use with bodies 3068-3071) (Rear wheel carrier) .....	1	-	-	1	-	-
214772	Rumble seat step lower assembly (Use with bodies 4068-4071) (Side wheel carrier) .....	1	-	-	1	-	-
211879	Rumble seat step lower assembly (Use with bodies 3068-3071) (Side wheel carrier) .....	1	-	-	1	-	-
175144	Rumble seat step lower clamp plate .....	2	-	-	2	-	-
7859	Screw 1/4-28 x 1-1/2" hex. hd. ....	2	-	-	2	-	-
7842	Screw 1/4-28 x 1-1/4" hex. hd. ....	2	-	-	2	-	-
5502	Lockwasher 1/4" .....	4	-	-	4	-	-
7004	Nut 1/4-28 .....	4	-	-	4	-	-
214768	Rumble seat step lower linoleum (Rear wheel carrier) .....	1	-	-	1	-	-
214753	Rumble seat step lower linoleum (Side wheel carrier) .....	1	-	-	1	-	-
206729	Rumble seat step upper assembly .....	1	-	-	1	-	-
114055	Washer 25/64 x 3/4 x 5/32" .....	3	-	-	3	-	-
5506	Lockwasher 3/8" .....	3	-	-	3	-	-
7006	Nut 3/8-24 .....	3	-	-	3	-	-
7811	Screw 5/16-24 x 1-3/8" hex. hd. ....	2	-	-	2	-	-
5504	Lockwasher 5/16" .....	2	-	-	2	-	-
179123	Rumble seat step upper liner .....	1	-	-	1	-	-
204938	Rumble seat step upper linoleum .....	1	-	-	1	-	-
214443	Rumble seat step upper bracket (Use with bodies 4068-4071) ..	1	-	-	1	-	-
206696	Rumble seat step upper bracket (Use with bodies 3068-3071) ..	1	-	-	1	-	-
214444	Rumble seat step upper bracket gasket (Use with bodies 4068-4071) .....	1	-	-	1	-	-
206698	Rumble seat step upper bracket gasket (Use with bodies 3068-3071) .....	1	-	-	1	-	-
211295	Windshield cleaner dash connection vacuum supply tube assembly .....	1	1	1	1	1	1

\* For items not listed herein see instructions on Page 2.



