

Service Parts List

PACKARD SUPER-EIGHT

1500-1501-1502

1603-1604-1605

PACKARD TWELVE

1506-1507-1508

1607-1608

1707-1708



Issued January, 1939

Copyrighted 1939

PACKARD MOTOR CAR COMPANY

DETROIT, MICHIGAN, U. S. A.

Litho. in U. S. A.

TO PACKARD DISTRIBUTERS AND DEALERS

In compiling this parts list we have endeavored to arrange in the most convenient manner, necessary data for ordering repair parts.

The text is indexed both alphabetically and numerically, with illustrations distributed so that each cut is in close relation to its text. Wiring diagrams are incorporated, which not only show the method of wiring these cars but also list the piece numbers of all units used in the electrical system.

Repair parts for some accessory units are herein listed and illustrated under the manufacturer's own piece number. Distributors should order these from the Packard factory and dealers should order from their distributor, using the manufacturer's piece number when no other number is shown. Customers should not be sent direct to the accessory manufacturer or their local agent for service.

SERIAL NUMBER LOCATION

Motor (1500-1-2) Top of crankcase--left forward side
Motor (1603-4-5) Top of crankcase--left side center
Motor (1506-7-8-1607-8-1707-8) Top of cylinder block--left forward side
Vehicle number Stamped on patent plate, fastened to front face of dash
Body dash serial Embossed in front face of dash

MOTOR NUMBER

1500-1501-1502--395,526 and up
1506-1507-1508--905,526 and up
1603-4-5--A500, 051 and up
1607-1608--A600,051 and up
1707-1708--B600,051 and up

ORDERING PARTS

Dealer Parts Orders should be sent to Distributors
Distributor Parts Orders should be sent to Packard Factory

Use only standard Distributer's Sundry and Part Order
forms No. D-19.

Correct "charge to" and "ship to" names and addresses
should be shown on every order.

Give piece number, name and quantity required.

Always advise motor or vehicle number.

State definite shipping instructions, i.e., parcel
post, express or freight, etc.

Give explicit instructions how cases are to be marked.

Detail ordering instructions as outlined in Technical
and Trade Letters should be adhered to in all cases.

In ordering utility parts always specify finish de-
sired.

Many special notes appear after the part names showing
some of the parts listed herein being used or not used on
certain models or body types and these notes should be
watched very carefully when ordering from this book.

ACCELERATOR

BODY

BONNET-BRAKE-BUMPER

CLUTCH-CONTROL

ELECTRICAL

EXHAUST

FENDERS

FRAME

GASOLINE

INSTRUMENT BOARD

LAMP-LICENSE PLATE
LOCK KEY

MOTOR

RADIATOR

REAR AXLE

SHOCK ABSORBERS

SPLASHER-SPRINGS-REAR

STEERING AND
STABILIZER

TOE BOARD-TOOLS

TRANSMISSION

TRUNK RACK

UNIVERSAL JOINT

WHEELS
WHEEL CARRIER

WHEEL
SUSPENSION FRONT

BODY TYPES

PACKARD SUPER-EIGHT			PACKARD TWELVE			PASS.	DESCRIPTION
1500	1501	1502	1506	1507	1508		
....	1012	1032	5	Formal Sedan
1003	1013	1023	1033	5	Touring Sedan
....	1014	1034	7	Touring Sedan
....	1015	1035	7	Touring Sedan Limo.
....	1016	1036	5	Club Sedan
....	1017	1037	5	Coupe
....	1018	1038	2-4	Coupe
....	1019	1039	2-4	Convertible Coupe
....	1007	1027	5	Victoria
....	1063	1073	5	Convertible Sedan
....	L394	L394	7	Cabriolet
....	L395	L395	7	Town Car

PACKARD SUPER-EIGHT			PACKARD TWELVE			PASS.	DESCRIPTION	
1603	1604	1605	1607	1608	1707			1708
....	1112	1132	1232	5	Formal Sedan
1103	1113	1133	1233	5	4-Door Tour. Sedan
....	1114	1134	1234	7	Touring Sedan
....	1115	1135	1235	7	Touring Sedan Limo.
....	1116	1136	1236	5	Club Sedan
....	1117	1137	1237	5	Coupe
....	1118	1138	1238	2-4	Coupe
....	1119	1139	1239	2-4	Convertible Coupe
....	1107	1127	1227	5	Victoria
....	1143	1153	1253	5	Convertible Sedan

PACKARD SUPER-EIGHT UPHOLSTERY

Following upholstery will be standard in Model 1500, 1501 and 1502--except formal sedans and limousines, business 7-sedans and business limousines.

No. 1407, a blue pin stripe broadcloth, will be standard in paint schemes A, B, L, Y and introductory paint schemes F and S.

No. 1409, a green pin stripe broadcloth, will be standard in paint schemes H, J and introductory paint scheme E.

No. 1477, a tan shadow stripe broadcloth will be standard in paint schemes G, P, T, X and introductory paint schemes K and Z.

No. 1496, a plain tan broadcloth, will be standard in all formal sedans and limousines.

A plain tan Bedford cord material will be standard for all business sedans and business limousines.

The standard upholstery for any paint scheme in Packard Super Eight cars may be used in any other paint scheme without extra charge.

The front compartment of all limousines, business or standard, will be upholstered in AR-3 black leather as standard. The exposed metal parts of partitions of all limousines will be painted black.

PACKARD TWELVE UPHOLSTERY

No. 734 for paint schemes A and Y.

No. 362 for paint scheme B.

No. 361 for paint scheme G and introductory paint scheme Z.

No. 925 for paint scheme H.

No. 736 for paint scheme J and introductory paint scheme E.

No. 319 for paint scheme L and introductory paint scheme F.

No. 347 for paint scheme P.

No. 749 for paint scheme T and introductory paint scheme K.

No. 743 for paint scheme X.

No. 767 for introductory paint scheme S.

The front compartment of all limousines will be upholstered in AR-3 black leather as standard. The exposed metal parts of partitions of all limousines will be painted black.

PACKARD SUPER-EIGHT AND PACKARD TWELVE LEATHER

For the purpose of these specifications, convertible cars will include coupe roadsters, convertible sedans and convertible victorias.

Following are the standard leathers for the paint schemes indicated in all Fifteenth Series Super Eight and Packard Twelve convertible cars and rumble seats in stationary coupes.

AR-5, a gray leather for paint schemes A, Y and introductory paint scheme S.

AR-7, a blue leather for paint schemes B, L and introductory paint scheme F.

AR-2, a brown leather for paint scheme G and introductory paint scheme Z.

AR-1, a green leather for paint schemes H, J and introductory paint scheme E.

AR-6, a tan leather for paint scheme P and introductory paint scheme K.

AR-3, a black leather for paint schemes T and X.

There is also a red leather AR-4 available without extra charge in any paint scheme.

The rumble seat only of the 2-passenger coupe will be trimmed standard in leather. Convertible cars will be upholstered standard in leather throughout.

PACKARD SUPER-EIGHT AND PACKARD TWELVE TOP MATERIAL

The top material for Fifteenth Series Super Eight and Packard Twelve convertible cars will be as follows:

No. 5000 for paint schemes G, H, J, P, T, X and introductory paint schemes K, E and Z.

No. 5060 for paint schemes A, B, L, Y and introductory paint schemes S and F.

CV-28, a black top material, optional on all models at no extra charge.

PAINT SCHEMES

SCHEME A

Entire car including steel or artillery wheels Gunmetal Light Metallic
Roof--fabric to match
..... Gunmetal Light Metallic
Stripe--body, bonnet and wheels
..... Flake White

SCHEME B

Entire car including steel or artillery wheels Packard Blue
Stripe--body, bonnet and wheels
..... Royal Blue

SCHEME E

Entire car including steel or artillery wheels Coachman Green
Roof--fabric to match .. Coachman Green
Stripe--body, bonnet and wheels
..... Cigarette Cream

SCHEME F

Entire car including steel or artillery wheels Regatta Blue Metallic
Roof--fabric to match
..... Regatta Blue Metallic
Stripe--body, bonnet and wheels
..... Silver

SCHEME G

Entire car including steel or artillery wheels Packard Maroon
Stripe--body, bonnet and wheels
..... Gold Bronze

SCHEME H

Entire car including steel or artillery wheels Hickory Leaf Green
Stripe--body, bonnet and wheels
..... Gold Bronze

SCHEME J

Entire car including steel or artillery wheels Almond Green Metallic
Roof--fabric to match
..... Almond Green Metallic
Stripe--body, bonnet and wheels . Silver

SCHEME K

Entire car including steel or artillery wheels Dawn Gray

Roof--fabric to match Dawn Gray
Stripe--body, bonnet and wheels
..... Royal Chariot Red

SCHEME L

Entire car including steel or artillery wheels Centennial Blue
Roof--fabric to match . Centennial Blue
Stripe--body, bonnet and wheels
..... Flake White

SCHEME P

Entire car including steel or artillery wheels Rich Loam Metallic
Roof--fabric to match. Rich Loam Metallic
Stripe--body, bonnet and wheels
..... Gold Bronze

SCHEME S

Entire car including steel or artillery wheels Iridium Gray Metallic
Roof--fabric to match
..... Iridium Gray Metallic
Stripe--body, bonnet and wheels
..... Flake White

SCHEME T

Entire car including steel or artillery wheels Packard Cream
Roof--fabric to match ... Packard Cream
Stripe--body, bonnet and wheels
..... Casino Red

SCHEME X

Entire car including steel or artillery wheels Black
Stripe--body, bonnet and wheels
..... Old Ivory

SCHEME Y

Entire car including steel or artillery wheels Buckingham Gray
Roof--fabric to match . Buckingham Gray
Stripe--body, bonnet and wheels
..... Silver

SCHEME Z

Entire car including steel or artillery wheels Indian Maroon
Roof--fabric to match ... Indian Maroon
Stripe--body, bonnet and wheels
..... Gold Bronze

GENERAL PART NAME INDEX

Part Name	Page No.
A	
Accelerator pedal stop - See Toe board.	229
Accelerator pedal - See Control	25
Adjusting plate - distributor	102
Air Cleaner - carburetor	86
Ammeter - See Instrument board	57-63
Anti-squeak	264-341-430
Arm Rest - See	
Arm rest rear seat side	264-342-430
Door arm rest	270-348-433
Rear seat folding arm rest.	309-392-456
Arm sling	431
Ash tray	265-344-431
Auto jack - See Tool jack	230
Automatic choke thermostat - carburetor.	85

B	
Backing light switch - transmission	231
Battery	27
Battery cover assembly - floor.	290-369-445
Body attaching parts	263-341-429
Body to frame bolts	263-341-429
Body to frame liners	263-341-429
Body hold down brackets - frame	48-52
Body hold down bolt bracket liners	263-341-429
Body wiring	287-365-443
Bonnet	1
Bonnet dash liner - See	
Dash panel	267-346-432
Bonnet ledge liner - radiator	182
Brake - hand	4
Brake drum - See	
Wheel hub and drum	245
Brake fluid	5
Brake - foot	5
Brake lining	9
Brake master cylinder	6
Brake pedal	6
Brake pedal shaft - See	
Clutch and brake pedal shaft	20
Brake hose union bracket - frame	48-52
Brake master cylinder bracket - frame	49-52
Brake shoes	9
Brake support plate	10
Brake tubes	10
Brake wheel cylinder	12
Breaker point sets	102
Bumper (front and rear)	13-18
Bumper support bar	14-19

C	
Cables - bulk stock	28
Cables - distributor	137

Part Name	Page No.
C - continued	
Cables sets	137
Cables - spark plug	143
Cable insulator	38
Cable terminal	38
Cams shaft	175
Carburetor	85-86-87
Carburetor throttle connecting rod - See	
Control	24
Carburetor tubes - fuel pump	139
Carpet - See	
Assembly carpet floor	331-419-368
Carrier - differential	194
Change speed lever - transmission	232
Change speed lever support liner - toe board	239
Cigar lighter - ash tray	267-344-431
Cigar lighter - instrument board	57-64
Clock - See	
Instrument board clock	57-64
Partition header clock	301-380-431
Clutch	29
Clutch and brake pedal dust cover - toe board	230
Clutch pedal	23
Clutch pedal spring - toe board	229
Clutch shaft - transmission	232
Coil - See	
Ignition coil and switch	137-138-140
Connecting rod - See	
Motor connecting rod	92
Steering connecting rod	218-227
Courtesy lamp	72-76
Crankcase	93
Crankshaft	94
Cross bar - bumper	14-18
Cross tube - steering	219
Cylinder - brake master	6
Cylinder - motor	100
Cylinder - brake wheel	12
Cylinder head	100

D	
Dash panel	267-344-431
Dictograph	287-366-443
Differential bearing - See	
Rear axle	194
Differential carrier - See	
Rear axle	194
Differential case - See	
Rear axle	195
Differential driving gear and pinion - See	
Rear axle	195
Differential gear - See	
Rear axle	199

GENERAL PART NAME INDEX

Part Name	Page No.	Part Name	Page No.
D - continued		F - continued	
Differential pinion - See		Flywheel	111
Rear axle differential pinion	199	Folding seat	292-372-446
Dimmer switch - See		Foot rest	293-372-447
Electrical foot dimmer switch	34	Foot dimmer switch	34
Distributor	102-103-105-109	Frame	48-51
Distributor cables	137	Front bumper - See	
Dome light	289-366-444	Bumper assembly front	13
Door trimmed - front	268-346-432	Front end panel	295-374-447
Door trimmed - rear	269-347-433	Front end chain - See	
Door trimming - See		Camshaft driving chain	84
Assembly door trimming	333-421-469	Front end cover - See	
Door arm rest	270-348-433	Motor gear cover	117
Door parts	270-348-433	Front fender	41-44
Door finishing mouldings - See		Front seat	295-375-448
Window finishing moulding -		Front spring	248
front	275-350-435	Front suspension	248
Window finishing moulding -		Fuel pump	112-115
rear	285-362-441	Fuel pump inlet tube - See	
Door scuff plate - floor	290-369-446	Gasoline fuel pump inlet tube	56
Driving gear and pinion - rear axle ...	195	Fuse - See	
Drive shaft assembly - distributor	102	Electrical lamp rear fuse	36
Drive shaft - oil pump	156	Electrical stoplight fuse	36
		Electrical wiring fuse (Aux.)	37
E		G	
Electrical body parts	286-365-443	Gasket equipment - See	
Electrical chassis parts	27	Motor carburetor gasket sets	85
Equalizer lever - brake	4	Motor gasket set	117
Exhaust manifold - See		Motor manifold gasket sets	144
Motor exhaust manifold	144	Gas gauge - See	
Exhaust muffler	38	Instrument board	58-65
Exhaust pipe	41	Gasoline tank	56
Exhaust valve	179	Gasoline tank gauge	56
Expansion tank - radiator	183-186	Gasoline tank support - frame	49-53
		Gasoline tubes	56
F		Gear cover	117
Fan	111	Gear and pinion - rear axle	195
Fan pulley - See		Generator	118-120-122-126-128
Crankshaft fan pulley	99	Generator regulator	131-133-135
Water pump shaft impeller and fan		Glass - See	
pulley	181	Front door	276-352-436
Fan shroud - radiator	183-186	Window wing	278-356-438
Fasteners	336-425-471	Rear door	285-364-441
Fenders - front	41-44	Partition window	303-383-452
Fenders - rear	43-47	Rear quarter window	305-386-454
Filter	148	Rear quarter window wing ..	306-389-454
Finishing plate - rear pillar	384-453	Rear window	310-395-457
Floor board - front and rear ..	290-369-445	Windshield	330-418-468
Floor carpet - See		Rear window - top	317-400-462
Assembly carpet floor	331-419-468	Golf compartment	301-380-450
Floor pad - See		Gravel shield - See	
Assembly pad floor	334	Rear fender pebble guard	44-47
Floor mats - See		Grease gun - See	
Mat floor	337-425	Tool grease gun	230
		Guard - bumper	13-19

GENERAL PART NAME INDEX

Part Name	Page No.	Part Name	Page No.
H			
Hand brake	4	Instrument board temperature gauge	71
Harness - wiring assembly	36	Instrument board thermometer	63
Hassock	301-380-451	Instrument board throttle connecting cable bracket - See	
Headlight - lamp front	72	Control	26
Headlight indicator light socket - electrical	37	Instrument board throttle control knob and cable assembly	63-71
Headlight switch - See		Intake manifold - motor	144
Instrument board	58		
Headlining - See			
Assembly headlining	334-422-469		
Hinges - See			
Front door	270-348-433		
Rear door	282-360-439		
Trunk lid	321-406-463		
Wheel compartment	325-412-465		
Horn	34		
Horn button - steering gear	223-229		
Horn relay - electrical	35		
Hub cap	245		
Hub shell cover	248		
I			
Ignition coil - motor	137-138-140		
Ignition coil cable dash grommet - control	26		
Ignition high and low tension cables - See			
Motor	137		
Ignition key - See			
Lock key	84		
Ignition spark plug - See			
Motor ignition spark plug	142		
Ignition switch	144		
Inlet valve	179		
Instrument board	57-63		
Instrument board ammeter	57-63		
Instrument board cigar lighter	57-64		
Instrument board compartment door ...	58-64		
Instrument board clock	57-64		
Instrument board gasoline gauge	58-65		
Instrument board headlamp switch assembly	58-68		
Instrument board light shield	58		
Instrument board oil gauge	58-69		
Instrument board panel	59-68		
Instrument board panel light switch ...	62-68		
Instrument board panel medallion	69		
Instrument board reading light sockets and cable	62-70		
Instrument board panel reading light switch	62-70		
Instrument board radio opening cover ...	62		
Instrument board steering post bracket support	63-71		
Instrument board speedometer	62-70		
Instrument board starter switch	63-71		
I - continued			
K			
		Key (ignition - front and rear door) ...	84
		Key - instrument board compartment ..	58-65
L			
		Lamp courtesy	72-76
		Lamp - front	72-76
		Lamp front switch - See	
		Instrument board headlamp switch ...	58
		Lamp - rear	73-80
		Lateral stabilizer bracket - See	
		Stabilizer lateral bracket	215
		Levers - See	
		Brake equalizer lever	4
		Hand brake lever	4
		License bracket - See	
		Lamp rear license bracket	76-83
		License plate - front bracket	83
		License tag bracket - See	
		Lamp rear license tag bracket ...	76-83
		Light switch - See	
		Instrument board panel light switch	62-68
		Locks - See	
		Front door	271-349-434
		Rear door	282-360-440
		Trunk lid	321-406-464
		Wheel compartment	325-412-465
		Lock key	84
		Louvers - See	
		Bonnet louvers	2
M			
		Mats - floor	337-425
		Master cylinder - brake	6
		Medallion - See	
		Instrument board panel medallion ...	68
		Motor accelerator pedal - See	
		Control	25
		Motor carburetor	85-86-90
		Motor camshaft	84
		Motor connecting rod	92

GENERAL PART NAME INDEX

Part Name	Page No.	Part Name	Page No.
M - continued		O - continued	
Motor crankcase	93	Oil pump	156
Motor crankshaft	94	Oil strainer	161
Motor cylinder	100	Outlet tube - exhaust muffler	40
Motor distributor	102-103-105-109		
Motor fan	111		
Motor flywheel	111	P	
Motor fuel pump	112-115	Patent plate	182
Motor gasket set	117	Pebble guard - See	
Motor gear cover	117	Rear fender pebble guard	44-47
Motor generator	118-120-122-126-128	Partition	301-380-451
Motor generator regulator	131-133-135	Partition window	303
Motor ignition coil	137-138-140	Pedal - See	
Motor ignition spark plug	142	Brake pedal	6
Motor ignition switch	144	Clutch pedal	23
Motor intake and exhaust manifold		Control accelerator pedal	25
assembly	144	Piston - motor	161
Motor oil cooler	147	Piston pin bushing - See	
Motor oil filler	148	Motor connecting rod	93
Motor oil filter	148	Piston ring set - motor	163
Motor oil level indicator	154	Piston skirt expander - motor	163
Motor oil manifold	154	Post and worm - See	
Motor oil pan	154	Shaft and worm	223-229
Motor oil pressure by-pass valve piston	155	Push rod	179
Motor oil pressure relief valve	155		
Motor oil pump	156	R	
Motor oil strainer	161	Radiator	182-185
Motor piston	161	Radiator hose - inlet and exhaust .	183-191
Motor spark plug - See		Radiator ornament - See	
Ignition spark plug	114	Radiator shell ornament	191
Motor stabilizer bracket	164	Radio opening cover	62
Motor starter motor and		Rain gutter moulding - roof ...	313-396-458
switch	164-166-168-172-174	Reading light cables and sockets	62-70
Motor support	176	Reading light switch - Instrument	
Motor support bushing - See		board	62-70
Motor gear cover motor support		Rear axle case	194
bushing	117	Rear axle differential	194
Motor support front bracket - frame	49	Rear axle shaft	199
Motor vacuum check valve	177	Rear axle spring - See	
Motor valve (inlet and exhaust)	179	Spring-rear	210
Motor vibration damper	180	Rear bumper - See	
Motor water pump	180	Bumper assembly - rear	13
Muffler - exhaust	38	Rear end panels	277-345
Muffler support bracket - frame	49-53	Rear fender	43-47
		Rear floor carpet - See	
O		Assembly carpet	331-419-468
Oil cooler	147	Rear floor mat - See	
Oil filler	148	Mat floor	337-425
Oil filter	148	Rear pillar finishing plate	384-453
Oil gauge	58-59	Rear quarter light	289-368-444
Oil pressure gauge tube assembly	59-69	Rear quarter window	304-385
Oil level indicator	154	Rear seat	309-390-456
Oil manifold	154	Rear seat pan and side sill -	
Oil pan	154	floor	292-371-446
Oil pressure by-pass valve piston	155	Rear view mirror	310-392-457
Oil pressure relief valve	155		

GENERAL PART NAME INDEX

Part Name	Page No.	Part Name	Page No.
R - continued		S - continued	
Rear wheel carrier	260	Steering column gear shift	224
Rear window	310-392-457	Steering connecting rod	218-227
Repair kit - See		Steering crank	218-227
Brake master cylinder	6	Steering crank mounting plate - frame 50-54	
Brake wheel cylinder	13	Steering cross tube	219-227
Robe rail	313-395-458	Steering gear	222-228
Rocker levers - camshaft	85	Steering gear horn button	223-229
Roof	313-395-458	Steering knuckle	249
Rumble seat	314-396-459	Steering post - See	
Running board	200-202	Steering gear shaft and worm	
Running board light switch - See		assembly	223-229
Electrical running board light door		Steering post bracket support - instrument	
switch	289-368-445	board	63-71
S		Steering wheel	224-229
Scuff plates - floor	290-369-446	Stop light switch - electrical	36
Shock absorber	203-205	Sun visor	316-399-460
Shock absorber valves	207	Support bar - bumper	14-19
Signal light - See		Support - battery	28
Electrical instrument board signal		Support - plate - brake	10
light socket and cables	35	Synchronizer brake - transmission	240
Side wheel carrier	261	T	
Silencer and air cleaner - carburetor ..	86	Tail lamp - See	
Skirt expander - piston	163	Lamp rear and bracket	73
Snap fasteners	337-426-471	Temperature gauge	63-71
Spark plugs - ignition	142	Thermometer - Instrument board	63
Spark plug cables - See		Thermostat - See	
Motor ignition spark plug cable ...	142	Automatic choke thermostat	85
Spark plug wrench - See		Manifold heat control thermostat ..	145
Tool spark plug wrench	230	Radiator shutter thermostat ...	185-193
Speedometer	62-70	Throttle control knob and cable	63-71
Speedometer driving gear - transmission	239	Throwout bearing - See	
Speedometer pinion and shaft -		Clutch shifter thrust bearing	234
transmission	239	Timing chain - See	
Splasher (frame to crankcase)	209	Motor camshaft driving chain	84
Spring - rear	210	Timing indicator - crankcase	94
Spring - front	248	Timing indicator - flywheel housing ...	112
Spring front rebound bumper bracket - See		Timing indicator - gear cover	117
Frame wheel front spring rebound bumper		Tire clamp	325-414-466
bracket	50-55	Tire pump - See	
Spring covers	210	Tool tire pump	230
Spring rear brackets - frame	50-54	Tire stop	325-414-466
Stabilizer - front	214	Toe board	229
Stabilizer bracket - motor	164	Toe board bracket and support plate -	
Stabilizer bracket - rear axle	199	front end	295-374
Stabilizer lateral	215	Toe board grommet - See	
Stabilizer lateral bracket - frame ..	50-54	Electrical wiring toe board grommet.	36
Stabilizer (rear) link	217	Toe board insulator - See	
Starter motor and		Electrical wiring toe board	
switch	164-166-168-172-174	insulator	38
Starter switch - See		Toggle grip	316-399
Instrument board	63-71	Tonneau light - electrical	289-368-445
Starter switch cable - battery	27	Tools	230
Steering column to instrument board		Top	317-399-460
bracket	217	Top dust cover	334

GENERAL PART NAME INDEX

Part Name	Page No.	Part Name	Page No.
T - continued		W	
Torque arm and stud assembly - See		Water jacket plate - motor cylinder ...	101
Wheel front torque arm and stud ...	259	Water pump	180
Torque arm bracket - See		Water seal - brake support plate	10
Frame wheel front torque arm		Wheels	245
bracket	50-55	Wheel carrier rear	260
Transmission	231	Wheel carrier side	261
Trimming material	331-419-468	Wheel compartment door	325-412-465
Trim ring - wheel	248	Wheel compartment tire clamp ..	325-414-466
Trunk lid	321-406-463	Wheel compartment tire stop ...	325-414-466
Trunk rack	240	Wheel cylinder - brake	12
Trunk emblem	318	Wheel front spring - See	
		Spring front	248
		Wheel front steering knuckle	249
		Wheel front support	253
		Wheel suspension front	248
		Wheel wrench - See	
		Tool wheel wrench	230
		Window finishing moulding - See	
		Front door window finishing	
		moulding	275-350-435
		Partition window finishing	
		moulding	303-383-451
		Rear quarter window finishing	
		moulding	305-386-454
		Rear window finishing	
		moulding	310-392-457
		Rear door window finishing	
		moulding	285-362-441
		Windshield	326-414-466
		Windshield cleaner	326-414-466
		Windshield finishing moulding .	330-418-467
		Windshield header finishing	
		moulding - front end	374-448
		Wiring assembly - See	
		Electrical	36
		Worm and post - See	
		Shaft and worm	223-229
		Z	
		Zippers	339-427-472

NUMERICAL INDEX

Part No.	Page	Part No.	Page	Part No.	Page	Part No.	Page	Part No.	Page
20075	154	39403	264	71397	28	112058	338	127273	199
20075	195	39403	326	71397	34	112058	426	127498	314
20075	222	39403	342	71397	70	112058	472	127498	396
21662	155	39403	430	71397	365	113822	336	127498	459
21964	200	45933	195	71397	443	113822	424	127501	314
21964	203	48202	34	77748	100	113822	470	127501	396
29254	287	48202	287	78945	101	113980	336	127501	459
29254	366	48202	365	79574	293	113980	424	127808	338
29254	443	48202	443	79574	372	113980	470	127808	427
29625	338	48317	369	79574	447	113981	336	127808	472
29625	427	48317	446	098218	144	113981	425	128040	339
29625	472	48616	34	100100	293	113983	337	128040	427
29627	338	51331	264	100100	372	113983	426	128040	472
29627	427	51331	342	100100	447	113983	471	129439	101
29627	472	51331	430	101200	42	114055	316	0130011	99
29637	338	53127	34	101200	45	114055	398	131046	222
29637	427	62065	1	101200	46	114055	460	131046	263
29637	472	62065	3	101200	326	114542	161	131046	341
29638	338	62065	4	102507	322	114673	99	131046	429
29638	427	62065	42	102585	289	114684	145	131316	278
29638	472	62065	45	102585	366	114684	154	131316	303
29640	338	62065	183	102585	444	114886	161	131316	356
29640	427	62065	186	102590	62	115026	336	131316	384
29640	472	62065	193	102590	72	115026	425	131316	438
29651	336	62065	267	102590	76	115798	337	131316	453
29651	424	62065	309	102590	83	115798	338	131801	429
29651	470	62065	318	102590	289	115798	426	131809	263
29664	265	62065	325	102590	368	115798	471	131809	341
29790	336	62065	346	102590	369	115799	337	131809	429
29790	424	62065	366	102590	444	115799	426	132177	179
29790	470	62065	391	102590	445	115799	471	132179	179
31338	375	62065	392	105029	265	117970	181	132429	278
31338	449	62065	406	105029	301	120813	99	132429	286
33287	28	62065	412	105029	303	120813	195	132429	303
33287	138	62065	414	105029	322	120917	94	132429	305
33287	286	62065	432	105029	344	122146	293	132429	313
33287	287	62065	444	105029	380	122146	374	132429	356
33287	344	62065	456	105029	383	122146	447	132429	365
33287	365	62065	457	105029	409	122611	298	132429	384
33287	366	62065	463	105029	431	122611	301	132429	395
33287	368	62065	465	105029	451	122611	379	132429	438
33287	369	62065	466	105161	56	122611	380	132429	442
33287	443	62455	214	107654	289	122611	450	132429	453
33287	444	62759	339	107654	368	122611	451	132429	454
33287	445	62759	427	107654	369	123094	267	132429	458
36111	34	62759	472	107654	444	123094	346	132585	41
36111	62	66570	84	107654	445	123094	432	132685	93
36111	64	67277	38	107889	195	123507	337	132972	272
36111	70	68073	38	107889	222	124617	199	132972	277
36111	138	68601	100	110196	94	124618	199	132972	283
36111	287	70128	59	110576	179	124631	199	132972	286
36111	304	70128	69	111074	267	125485	101	132972	303
36111	344	70128	329	111074	346	125863	99	132972	305
36111	365	70128	417	111074	432	126985	199	132972	350
36111	366	70128	467	111687	325	127253	424	132972	355
36111	385	70134	258	111687	412	127259	335	132972	359
36111	443	070296	76	111687	465	127259	423	132972	361
36111	453	070296	83	111980	99	127259	470	132972	365

NUMERICAL INDEX

Part No.	Page	Part No.	Page	Part No.	Page	Part No.	Page	Part No.	Page
132972	384	133429	389	140174	390	156596	470	162552	186
132972	389	133933	182	140174	455	156625	137	162623	156
132972	390	135117	337	140855	43	156625	143	162624	102
132972	395	135117	426	140935	337	156626	137	163168	278
132972	435	135117	471	140935	426	156626	143	163168	286
132972	437	135807	301	140935	471	156692	336	163168	303
132972	440	136008	278	141358	198	156692	425	163168	305
132972	442	136008	286	141409	99	156692	471	163168	313
132972	453	136008	303	141459	195	156696	470	163168	356
132972	454	136008	305	141460	195	156857	336	163168	365
133004	287	136008	313	141532	41	156857	425	163168	384
133004	366	136008	356	141533	41	156857	471	163168	389
133004	443	136008	365	141903	195	157022	338	163168	395
133264	272	136008	384	142020	111	157022	427	163168	438
133264	277	136008	389	142989	183	157022	472	163168	442
133264	281	136008	395	142989	191	157435	4	163168	453
133264	283	136008	438	143143	26	157477	59	163168	454
133264	286	136008	442	143360	329	157477	69	163168	458
133264	303	136008	453	143459	199	157477	70	0163879	162
133264	306	136008	454	143554	303	157477	326	0163880	162
133264	349	136008	458	143554	383	157584	314	0163881	162
133264	355	136593	289	143554	452	157584	396	0163882	162
133264	359	136593	368	143615	301	157584	459	164239	303
133264	361	136593	444	143615	380	157585	314	164239	383
133264	365	136593	445	143615	450	157585	398	164239	451
133264	384	136832	336	144514	145	157585	459	164359	281
133264	390	136832	425	144514	146	157586	338	164359	360
133264	395	136832	471	144926	37	157586	427	164359	439
133264	435	136833	336	144926	143	157586	472	0164630	162
133264	437	136833	425	144930	154	157625	316	0164631	162
133264	440	136833	471	145255	145	157625	398	0164632	162
133264	442	137510	337	145661	322	157625	460	0164633	162
133264	452	137510	426	146303	94	158003	215	0164634	162
133339	272	137510	471	147114	293	158003	260	164700	281
133339	277	138118	111	147114	374	158042	162	164700	360
133339	281	138121	194	147114	447	158137	84	164700	439
133339	283	138551	214	147237	84	158185	101	166403	28
133339	286	138694	23	147253	85	158670	99	166403	287
133339	303	139150	337	147254	84	158686	99	166403	365
133339	305	139150	338	147289	180	158687	99	166403	443
133339	349	139150	426	147294	180	158688	99	166404	28
133339	355	139150	427	147295	101	159060	338	166404	287
133339	359	139150	472	147910	281	159060	426	166404	365
133339	361	139157	338	147910	306	159060	472	166404	443
133339	365	139157	427	147910	313	159698	101	166405	28
133339	384	139157	472	147910	359	161778	337	166405	287
133339	389	139466	57	147910	390	161778	425	166405	365
133339	390	139515	214	147910	439	161778	471	166405	443
133339	395	139521	43	147910	455	161787	336	166406	287
133339	435	139521	45	147910	458	161787	424	166406	365
133339	437	139521	46	148338	314	161787	470	166406	443
133339	439	139521	200	148338	398	161792	425	0166698	93
133339	440	139910	334	148338	459	161792	471	166872	28
133339	442	139910	423	156346	471	161794	425	167069	287
133339	453	140067	194	156348	471	161794	471	167069	365
133339	454	140076	27	0156494	93	162389	44	167069	443
133339	455	140079	199	156596	335	162389	47	167261	25
133339	458	140174	306	156596	423	162552	183	167261	144

NUMERICAL INDEX

Part No.	Page	Part No.	Page	Part No.	Page	Part No.	Page	Part No.	Page
167438	335	0176265	99	182894	337	184851	447	185601	281
167438	423	0176266	99	182894	426	184852	293	185601	348
167914	470	0176268	99	182894	471	184852	372	185601	360
169182	8	176282	325	183170	271	184852	447	185601	433
169182	23	176282	412	183170	282	184853	292	185601	439
169249	336	176282	465	183170	349	184853	372	185602	270
169249	424	176578	470	183170	360	184853	446	185602	281
169249	470	0176585	99	183170	434	184863	336	185602	348
170074	111	0176586	99	183170	440	184863	425	185602	360
170081	117	0176588	99	183171	271	184863	471	185602	433
170082	156	0176589	99	183171	282	184866	372	185602	439
170088	179	0176592	199	183171	349	184866	446	185832	290
170148	100	177812	335	183171	360	184876	264	185832	369
170401	37	177812	424	183171	434	184876	341	185832	445
170522	117	177812	470	183171	440	184876	430	186242	214
170945	72	177813	335	183741	339	0185064	72	186243	214
170966	305	177813	424	183741	427	0185064	76	186330	75
170966	386	177813	470	183741	472	185111	293	186330	82
170966	454	177851	326	183758	180	185111	372	186436	8
171863	28	177923	94	183759	180	185111	447	186501	199
171863	365	179131	318	183761	180	185113	292	186662	163
171863	368	179131	400	183763	180	185113	372	187144	344
171863	443	179131	462	183764	180	185113	447	187260	182
171863	445	179157	214	183770	180	185114	293	187483	316
172180	99	179169	100	183836	289	185114	372	187483	399
172182	99	179250	28	183836	368	185114	447	187483	431
172183	99	179251	287	183836	369	185118	293	187525	264
172184	99	179251	365	183836	444	185118	372	187525	342
172185	99	179251	443	183836	445	185118	447	187594	322
172187	99	179586	332	183962	201	185211	336	187594	409
172188	99	180001	145	183986	337	185211	424	187596	322
172190	99	180004	144	183986	425	185211	471	187596	409
172294	292	180082	322	183986	471	185236	272	187803	267
172294	372	180082	409	184259	292	185236	283	187803	346
172294	447	180082	464	184259	372	185236	325	187803	432
172470	339	180134	293	184259	446	185236	414	190021	162
172470	427	180134	374	184260	292	185236	465	190091	75
172470	472	180134	447	184260	372	185270	263	190091	82
173243	336	180523	185	184260	446	185270	341	190092	75
173243	424	180671	306	184268	292	185270	429	190092	82
173411	316	180671	313	184268	372	185273	263	190231	63
173411	398	0180750	194	184268	447	185273	341	190231	71
173411	460	181221	72	184270	292	185273	429	190291	5
174216	301	181221	76	184270	372	185273	430	190291	23
174216	380	181545	264	184270	446	185274	263	190332	75
175757	337	181545	342	184310	94	185274	341	190332	82
175757	338	181545	430	184433	321	185274	429	190472	180
175757	426	182215	1	184433	409	185412	338	190475	94
175757	427	182215	2	184433	464	185412	426	190503	94
175757	471	182215	186	184682	292	185412	472	190542	144
175757	472	182439	263	184682	372	185416	180	190544	144
175763	278	182439	341	184692	270	185600	270	190680	183
175763	281	182439	429	184692	348	185600	281	190680	186
175763	355	182459	62	184692	434	185600	348	190729	38
175763	437	182478	84	184710	184	185600	360	190729	41
175911	145	182687	339	184722	181	185600	433	191157	3
175911	181	182687	427	184851	293	185600	439	191161	3
0176263	94	182687	472	184851	372	185601	270	191654	182

NUMERICAL INDEX

Part No.	Page	Part No.	Page	Part No.	Page	Part No.	Page	Part No.	Page
191671	85	195338	425	197539	180	199045	468	201669	184
192303	337	195338	471	197648	84	199114	58	201677	179
192303	426	195664	425	197652	102	199167	270	201710	286
192303	471	195664	471	197657	100	199167	281	201710	287
192345	338	195680	57	197677	156	199167	348	201736	28
192345	427	195717	365	197680	156	199167	359	201736	287
192345	472	195717	442	197681	156	199167	433	201737	28
192346	338	195903	180	197682	156	199167	439	201768	75
192346	427	195916	180	197683	84	199374	322	201768	82
192346	472	195917	180	197695	100	199571	303	201811	39
193199	338	195919	180	197696	100	199571	383	201811	40
193199	427	196243	314	197697	100	199571	451	201860	180
193199	472	196243	398	197698	180	199718	298	201864	117
193200	338	196243	459	197705	85	199786	418	201865	117
193200	427	196708	194	197706	181	199786	467	201887	99
193200	472	196709	194	197711	85	199787	1	201894	181
193201	338	196719	198	197711	148	199892	366	201910	100
193201	426	196720	198	197720	181	199965	282	201946	179
193201	472	196721	198	197733	161	199965	360	202056	4
193352	339	196726	198	197736	154	199965	439	202188	183
193352	427	196735	198	197736	161	200073	337	202188	191
193352	472	196738	198	197749	112	200073	426	202223	28
193674	264	196739	195	197750	101	200073	471	202369	195
193730	265	196740	198	197750	112	200467	336	202370	195
193730	343	196741	195	197758	102	200467	424	202572	177
193730	430	196742	199	197759	154	200467	471	202573	177
194019	37	196743	199	197761	148	200638	338	202599	24
194151	37	196801	194	197762	154	200638	427	202601	24
194182	195	196807	194	197763	148	200639	338	202699	9
194198	28	196808	195	197766	180	200639	427	202716	9
194218	28	196849	194	197777	145	200995	336	202719	10
194219	28	196850	194	197779	100	200996	336	202721	9
194286	287	196878	259	197782	100	200996	424	202747	9
194286	365	196881	20	197783	156	200996	470	0202800	162
194286	443	196973	329	197784	161	201052	179	0202801	162
0194400	163	196973	417	197787	144	201053	117	0202802	162
0194401	163	197093	194	197790	101	201063	102	0202803	161
0194402	163	197094	194	197791	101	201066	112	0292804	162
0194403	163	197095	194	197802	146	201067	86	0202805	162
0194404	163	197101	194	197803	145	201069	102	0202806	162
0194405	163	197102	195	197804	86	201070	84	0202814	162
0194406	163	197106	195	197804	117	201071	84	0202815	162
0194453	76	197107	195	197804	146	201167	41	202838	162
0194453	83	197114	195	197806	144	201218	181	0202843	194
194601	1	197115	198	197816	100	201218	183	202876	100
194601	2	197116	198	197817	146	201218	191	202895	84
194607	43	197119	198	197819	102	201253	195	202909	326
194732	2	197121	198	197820	181	201259	194	202917	406
194732	26	197122	198	197821	101	201260	195	202917	463
194829	182	197123	198	197828	148	201458	28	202926	34
194831	182	197125	199	197830	144	201480	38	202941	9
194894	182	197126	199	197861	101	201504	23	202953	181
194974	59	197127	199	197877	38	201508	194	203001	161
194974	69	197130	199	197983	36	201570	27	203002	161
195201	293	197260	111	199045	267	201570	37	203008	161
195201	374	197493	369	199045	344	201643	260	203014	161
195201	447	197493	445	199045	418	201644	260	203042	99
195338	336	197638	179	199045	431	201652	198	203048	84

NUMERICAL INDEX

Part No.	Page	Part No.	Page	Part No.	Page	Part No.	Page	Part No.	Page
203050	84	205043	179	206825	23	209817	9	211409	356
203063	84	205139	143	206825	25	209851	37	211409	438
203064	84	205172	85	206919	293	209851	38	211539	293
203065	84	205176	179	206919	372	209851	62	211539	301
203083	101	205354	102	206919	447	209851	71	211648	309
203083	183	205429	86	206920	293	209856	8	211648	392
203083	191	205429	145	206920	372	209858	137	211648	457
203177	177	205611	86	206920	447	210009	145	211649	278
203178	177	205679	183	207079	38	210016	146	211649	306
203198	117	205680	183	207085	199	210024	147	211649	356
203269	181	205684	199	207286	183	210058	198	211649	389
203275	181	205687	86	207332	260	210059	198	211649	438
203280	181	205817	145	207427	199	210060	198	211649	455
203286	181	205818	145	207428	199	210064	198	211809	309
203287	111	205819	145	207430	199	210070	329	211809	392
203288	111	205975	183	207477	28	210070	414	211809	457
203301	83	205975	186	207518	185	210070	466	212168	272
203301	76	205981	102	207520	85	210071	93	212168	283
203427	214	205981	148	207525	85	210121	184	212366	278
203454	101	206017	272	207536	185	210127	112	212366	306
203460	181	206017	283	207542	177	210128	112	212366	356
203635	85	206043	272	207570	94	210140	199	212366	389
203734	199	206043	283	207571	111	210201	195	212366	438
203735	199	206090	372	207582	164	210208	145	212366	455
203736	199	206130	295	207589	112	210227	144	212490	281
203782	182	206130	374	207608	84	210231	144	212490	306
203791	146	206130	447	207622	156	210245	85	212490	356
203792	146	206132	295	207657	177	210297	1	212490	389
203802	154	206132	374	207661	177	210442	86	212490	438
203802	161	206132	447	207750	8	210454	146	212490	455
203803	182	206134	293	207750	262	210473	198	212602	309
203806	179	206134	372	207800	63	210481	198	212602	392
203808	180	206134	447	207804	102	210608	144	212602	457
203809	182	206136	374	207815	164	210629	180	212652	374
203815	180	206139	374	207829	26	210647	180	212653	374
203874	101	206140	372	207830	112	210776	9	212655	372
203891	199	206141	374	207994	94	210915	23	212656	374
203902	9	206187	272	209000	111	211003	287	212683	296
203905	27	206187	283	209018	144	211003	444	212683	376
203905	37	206188	272	209027	138	211021	277	212683	449
203911	180	206188	283	209054	94	211021	286	212848	298
203923	85	206188	325	209116	84	211021	303	212848	379
203940	180	206223	272	209129	28	211021	305	212848	450
203946	180	206223	283	209169	12	211026	265	212849	298
203950	179	206656	338	209228	218	211026	431	212849	379
203951	180	306656	427	209332	112	211035	272	212849	450
203952	179	206657	338	209339	112	211035	277	212850	298
203953	179	206657	427	209571	146	211035	283	212850	379
203954	179	206657	472	209524	200	211035	286	213162	144
203955	179	306709	313	209525	200	211035	303	0213164	207
203956	179	306710	313	209611	38	211035	305	213192	184
203957	180	206731	423	209611	56	211059	417	213338	63
203960	179	206731	335	209676	10	211059	467	213340	63
203961	180	206731	470	209713	101	211171	337	213372	23
203976	101	206744	338	209713	102	211171	426	213377	24
204683	326	206744	426	209713	153	211171	471	213378	24
204683	330	206744	427	209763	117	211205	3	213379	24
205042	179	206744	472	209771	117	211409	281	213381	24

NUMERICAL INDEX

Part No.	Page	Part No.	Page	Part No.	Page	Part No.	Page	Part No.	Page
213384	24	215384	137	216464	156	218522	310	219957	180
213387	20	215422	84	216548	219	218522	330	219958	180
213472	146	215423	84	216549	218	218600	282	219959	181
213480	146	215430	100	216631	181	218600	360	219960	145
213481	146	215452	156	216655	57	218600	440	219961	145
213484	146	215454	156	0216660	162	218685	270	219967	179
213493	145	215455	161	0216661	162	218685	281	219968	179
213505	145	215458	156	0216662	162	218685	348	219969	179
213518	146	215465	179	0216663	163	218685	360	219970	145
213578	145	215467	179	0216664	163	218685	433	219988	147
213642	20	215470	179	0216665	163	218685	439	219994	147
213744	146	215472	155	0216666	163	218823	72	219997	177
213745	146	215474	156	0216667	163	218823	76	220528	286
213746	146	215475	156	0216668	163	0218824	72	220528	364
213747	146	215476	156	0216678	163	0218824	76	220528	442
213771	94	215478	20	0216679	163	218826	384	220529	286
213902	101	215480	155	0216680	163	218826	453	220529	364
0213935	93	215481	180	0216681	163	219050	112	220529	442
0213936	93	215482	84	0216682	163	219164	59	220530	285
0213980	162	215483	84	0216684	163	219164	69	220530	364
0213981	162	215488	161	0216686	163	219165	59	220530	441
0213982	163	215489	156	216724	11	219165	69	220558	309
0213983	163	215491	161	216764	86	219209	199	220558	390
214054	336	215546	59	216765	85	219254	181	220558	456
214054	425	215546	69	216887	59	219284	179	220559	309
214109	337	215640	85	216887	69	219286	179	220559	390
214109	425	215646	84	216915	201	219312	144	220559	456
214109	471	215648	12	216915	202	219524	194	220560	306
214211	339	215648	24	218000	335	219525	194	220560	389
214212	339	215649	25	218001	336	219526	194	220560	455
214213	339	215844	59	218001	424	219591	179	220562	306
214213	427	215844	69	218016	335	219594	93	220562	389
214213	472	215947	156	218016	419	219704	94	220562	455
214561	374	216117	46	218105	368	219712	148	220565	306
214562	339	216130	85	218105	444	219737	111	220565	389
214562	427	216132	85	218108	335	219752	261	220565	454
214620	344	216138	156	218128	336	219808	111	220571	306
214901	304	216140	156	218128	425	219812	144	220571	389
214901	385	216164	156	218162	336	219815	154	220571	454
214901	453	216205	28	218169	336	219820	181	220572	306
214974	338	216206	28	218169	425	219826	144	220572	389
214974	426	216214	93	218169	471	219888	85	220572	455
214974	472	216233	162	218170	336	219891	154	220573	306
215054	84	216235	163	218170	425	219893	118	220573	389
215057	84	216287	155	218170	471	219895	118	220573	455
215058	84	216320	155	218183	332	219907	156	220574	306
215059	84	216340	155	218183	420	219909	154	220574	389
215074	84	216371	101	218305	270	219920	154	220574	454
215090	182	216371	205	218305	281	219921	180	220575	356
215091	182	216371	207	218305	348	219926	85	220575	438
215099	155	216371	217	218305	359	216927	138	220576	306
215100	155	216375	156	218305	433	219933	183	220576	389
215104	155	216378	161	218305	439	216945	28	220576	455
215110	155	216389	99	218322	330	219945	101	220579	306
215117	154	216406	156	218522	276	219947	144	220579	389
215119	155	216436	156	218522	285	219948	100	220579	454
0215177	112	216448	154	218522	303	219952	145	220580	306
215185	199	216449	156	218522	305	219954	137	220580	389

NUMERICAL INDEX

Part No.	Page	Part No.	Page	Part No.	Page	Part No.	Page	Part No.	Page
220580	455	220633	356	220694	278	220783	465	221002	137
220582	309	220633	438	220694	355	220797	297	221003	117
220582	390	220634	276	220694	437	220797	379	221004	117
220582	455	220634	352	220695	278	220797	449	221005	181
220583	309	220634	436	220695	305	220814	309	221006	112
220583	390	220640	277	220695	355	220839	310	221011	102
220583	455	220640	355	220695	389	220839	392	221014	143
220585	309	220640	437	220695	437	220844	330	221016	143
220585	390	220641	281	220695	454	220845	330	221035	177
220585	455	220641	359	220696	286	220846	330	221036	177
220586	309	220641	438	220696	303	220851	326	221040	84
220586	390	220642	281	220696	365	220852	326	221042	118
220586	455	220642	359	220696	384	220853	326	221055	101
220587	309	220642	438	220696	442	220854	326	221061	144
220587	390	220643	306	220696	453	220855	326	221065	20
220587	455	220643	390	220697	286	220859	330	221066	24
220588	309	220643	455	220697	365	220860	329	221076	181
220588	390	220644	306	220697	442	220870	58	221080	154
220588	455	220644	390	220698	278	220872	310	221084	181
220592	285	220644	455	220698	356	220872	395	221204	99
220593	285	220650	281	220698	437	220872	457	221205	99
220600	281	220650	359	220706	286	220878	298	221260	23
220600	306	220650	439	220706	365	220878	379	221290	198
220600	356	220651	281	220706	442	220878	450	221369	94
220600	389	220651	359	220711	322	220879	298	221409	144
220600	438	220651	439	220712	275	220879	379	221413	148
220600	455	220652	278	220712	350	220879	450	221415	147
220618	278	220652	356	220713	275	220881	316	221415	155
220618	356	220652	438	220713	351	220881	398	221432	218
220618	438	220653	278	220715	330	220881	460	221441	218
220620	278	220653	356	220715	418	220882	313	221462	101
220620	356	220653	438	220715	468	220882	395	221484	38
220620	438	220660	305	220717	322	220883	313	221498	99
220621	286	220660	389	220718	322	220883	396	221499	142
220621	364	220660	454	220719	322	220883	458	221509	4
220621	442	220661	305	220723	322	220924	310	221545	24
220622	277	220661	389	220726	322	220924	395	221547	263
220622	355	220661	454	220729	275	220924	457	221547	341
220622	437	220662	305	220729	350	220956	272	221547	429
220624	276	220662	389	220730	275	220956	282	221618	3
220624	352	220662	454	220730	350	220957	271	221631	92
220624	436	220663	306	220735	322	220957	282	221632	92
220625	278	220663	389	220750	58	220957	283	221640	3
220625	356	220663	454	220761	72	220959	272	221716	199
229625	438	220674	305	220761	76	220959	282	221717	199
220626	277	220674	386	220761	289	220963	325	221721	205
220626	355	220675	305	220761	366	220972	310	221721	207
220626	437	220675	386	220761	368	220972	392	221721	217
220627	277	220679	305	220761	444	220972	457	221725	205
220627	355	220679	386	220761	445	220976	267	221725	207
220627	437	220680	305	220771	369	220976	346	221725	217
220628	277	220680	386	220771	445	220976	432	221910	3
220628	355	220689	278	220772	369	220977	297	221924	3
220628	437	220689	355	220772	446	220979	295	221947	23
220629	277	220689	437	220773	369	220984	310	221950	101
220629	355	220693	277	220773	446	220984	392	221951	101
220629	437	220693	355	220783	325	220984	457	221953	182
220633	278	220693	437	220783	412	221000	137	221953	186

NUMERICAL INDEX

Part No.	Page	Part No.	Page	Part No.	Page	Part No.	Page	Part No.	Page
221978	182	223637	201	224101	439	224214	383	224319	430
221978	186	223638	201	224102	282	224214	392	224320	343
221981	182	223639	201	224102	360	224214	451	224320	430
221981	186	223659	144	224102	439	224214	457	224331	310
221987	23	223660	137	224103	282	224227	303	224332	310
223005	48	223663	137	224103	360	224227	384	224332	392
223005	52	223665	144	224103	439	224227	453	224332	457
223007	48	223685	101	224106	282	224230	304	224342	304
223007	52	223711	85	224106	360	224230	385	224342	385
223069	3	223713	218	224106	439	224230	453	224342	455
223070	3	223714	63	224107	282	224237	304	224343	304
223071	3	223714	71	224107	360	224237	385	224343	385
223072	3	223737	63	224107	439	224237	453	224343	453
223079	148	223740	182	224115	304	224246	310	224376	264
223103	1	223742	182	224115	385	224251	268	224377	264
223104	1	223747	117	224115	454	224262	322	224378	264
223123	24	223787	62	224119	281	224262	409	224379	264
223127	164	223789	62	224119	306	224262	464	224392	304
223132	112	223796	137	224119	313	224263	322	224392	385
223142	330	223822	200	224123	267	224263	409	224392	453
223180	41	223840	194	224124	267	224263	464	224403	292
223236	182	223842	194	224129	303	224265	287	224403	371
223236	185	223889	62	224129	383	224265	366	224404	292
223242	182	223889	65	224129	452	224265	443	224404	371
223242	185	223904	200	224130	297	224267	391	224407	292
223265	182	223905	200	224131	297	224267	456	224407	371
223265	185	223906	200	224132	296	224279	316	224407	446
223329	1	223907	42	224133	296	224286	292	224408	292
223432	1	223908	42	224137	304	224286	371	224408	371
223433	1	223930	62	224137	385	224287	292	224408	446
223434	1	223933	62	224137	454	224287	371	224411	304
223435	1	223940	62	224142	265	224287	446	224411	385
223437	1	223942	24	224142	343	224302	298	224411	453
223438	1	223950	62	224142	430	224302	379	224426	326
223443	1	223966	204	224143	265	224302	450	224432	303
223444	1	223966	206	224143	343	224303	297	224432	384
223472	182	223978	72	224143	430	224303	377	224432	452
223473	4	223978	77	224150	295	224303	449	224435	326
223473	182	224064	292	224150	374	224304	337	224442	287
223480	1	224064	372	224150	447	224304	426	224442	365
223481	1	224064	447	224154	292	224304	471	224442	443
223500	48	224065	292	224154	372	224305	292	224456	304
223500	52	224065	372	224154	446	224305	371	224456	385
223503	183	224065	446	224176	303	224306	292	224457	304
223504	183	224072	267	224176	383	224306	371	224457	385
223511	143	224072	346	224180	303	224307	292	224458	304
223522	183	224072	431	224180	384	224307	371	224458	385
223577	75	224082	309	224180	452	224307	446	224458	453
223577	82	224082	392	224188	265	224308	292	224459	304
223587	4	224082	457	224188	343	224308	371	224459	385
223599	198	224090	282	224195	301	224308	446	224459	453
223630	201	224090	360	224195	380	224309	304	224460	304
223631	201	224090	440	224195	451	224309	385	224460	385
223632	201	224100	282	224213	303	224309	454	224461	304
223633	201	224100	360	224213	384	224310	305	224461	385
223634	201	224100	439	224213	452	224310	386	224462	304
223635	201	224101	282	224214	303	224310	454	224462	385
223636	201	224101	360	224214	310	224319	343	224462	453

NUMERICAL INDEX

Part No.	Page	Part No.	Page	Part No.	Page	Part No.	Page	Part No.	Page
224463	304	224670	326	224794	456	224918	309	0225192	92
224463	385	224675	267	224805	305	224918	457	0225193	92
224463	453	224675	344	224805	389	224936	303	0225194	92
224488	309	224676	322	224805	454	224936	383	0225195	92
224488	391	224676	409	224806	305	224936	452	0225196	92
224488	456	224695	305	224806	386	224948	313	0225202	92
224489	309	224695	386	224806	454	224948	396	0225203	92
224489	391	224696	305	224811	325	224948	458	0225204	92
224489	456	224696	386	224824	303	224951	265	0225205	93
224490	309	224704	301	224824	384	224951	343	0225206	93
224490	391	224704	380	224824	452	224952	265	0225207	93
224490	456	224704	450	224828	325	224952	343	0225208	93
224503	322	224705	301	224831	314	224952	430	0225209	93
224503	409	224705	380	224831	398	224957	303	0225210	93
224504	267	224705	451	224831	459	224957	384	0225211	93
224504	344	224712	301	224840	325	224957	452	225250	59
224519	267	224712	380	224840	412	224961	314	225250	69
224519	344	224712	451	224840	465	224961	398	225251	59
224534	293	224713	301	224852	305	224961	459	225251	69
224534	447	224713	380	224852	386	224973	325	225253	59
224535	316	224713	450	224852	454	224973	412	225253	70
224536	316	224714	316	224853	305	224973	465	225259	42
224537	293	224715	314	224853	386	224992	264	225259	45
224544	281	224715	398	224853	454	224993	264	225261	35
224544	306	224715	459	224854	285	224998	265	225262	35
224545	281	224716	314	224854	364	224998	343	225262	36
224545	306	224716	396	224854	441	225005	62	225262	65
224548	293	224716	459	224857	286	225007	57	225262	68
224549	293	224717	314	224857	364	225007	63	225262	70
224550	289	224717	396	224857	442	225013	1	225263	35
224554	289	224717	459	224858	286	225014	1	225263	36
224555	293	224718	314	224858	365	225015	1	225263	65
224555	447	224718	396	224858	442	225016	1	225263	68
224556	293	224718	459	224860	265	0225020	100	225263	70
224556	447	224719	314	224860	343	0225021	100	225264	36
224557	313	224719	396	224876	265	0225062	100	225264	68
224558	447	224719	459	224876	343	0225063	100	225264	70
224559	289	224728	301	224877	286	225083	38	225351	3
224562	293	224728	380	224877	364	225105	184	225352	145
224563	293	224728	451	224877	442	225111	184	225353	145
224566	296	224729	301	224878	286	225111	192	225363	3
224566	376	224729	380	224878	364	225114	185	225370	28
224566	449	224729	451	224878	442	225116	185	225371	28
224573	293	224744	316	224883	285	225117	185	225372	28
224574	293	224775	264	224884	285	225117	193	225373	28
224574	447	224775	341	224385	44	225123	184	225374	28
224597	289	224775	430	224885	47	225132	184	225376	28
224629	322	224781	303	224886	44	225134	185	225377	28
224629	409	224781	384	224886	47	225136	184	225377	64
224629	464	224781	453	224887	418	225140	3	225377	286
224635	296	224789	309	224887	468	225141	3	225377	287
224637	297	224789	391	224905	325	225148	326	225377	365
224647	322	224789	456	224910	325	225149	72	225377	443
224654	43	224790	309	224910	414	225158	2	225393	3
224668	330	224790	391	224910	465	225159	2	225394	3
224668	417	224790	456	224911	281	225160	45	225397	183
224668	467	224794	309	224914	265	225183	62	225436	183
224669	326	224794	391	224914	343	225190	62	225436	186

NUMERICAL INDEX

Part No.	Page	Part No.	Page	Part No.	Page	Part No.	Page	Part No.	Page
225440	3	225929	4	226083	58	226330	310	226572	385
225441	3	225950	3	226091	310	226331	310	226573	304
225454	59	225955	42	226118	334	226333	297	226573	385
225454	69	225958	72	226161	339	226333	379	226574	304
225454	70	225986	24	226161	427	226335	314	226574	385
225465	57	225997	24	226161	472	226335	396	226574	453
225467	34	226002	313	226168	339	226335	459	226575	304
225482	12	226002	395	226188	334	226338	303	226575	385
225482	24	226002	458	226203	310	226338	383	226575	453
225505	3	226003	313	226203	395	226338	451	0226583	72
225506	147	226003	396	226203	457	226353	376	0226583	76
225514	27	226003	458	226223	310	226361	298	226595	72
225518	4	226004	313	226223	395	226361	379	226595	76
225520	34	226004	396	226223	457	226361	450	226649	334
225521	3	226004	458	226231	313	226381	305	226650	334
225531	4	226005	313	226231	395	226381	386	226651	334
225598	72	226005	396	226231	458	226381	454	226652	334
0225600	58	226005	458	226233	313	226387	265	226653	334
0225601	58	226006	313	226235	313	226387	343	226654	334
225610	112	226006	396	226235	395	226387	431	226655	334
225614	177	226006	458	226235	458	226425	334	226656	334
225632	75	226008	43	226236	313	226425	423	226695	332
225632	82	226025	303	226236	395	226425	470	226722	298
225642	57	226025	383	226236	458	226432	332	226722	379
225655	68	226025	451	226237	310	226432	420	226722	450
225655	70	226026	301	226237	395	226432	469	226741	296
225655	72	226026	380	226261	292	226437	333	226749	297
225655	77	226026	451	226261	371	226437	420	226749	377
225659	72	226030	281	226261	446	226437	469	226751	296
0225673	207	226031	322	226262	292	226491	375	226771	44
225678	37	226031	409	226262	371	226491	448	226771	47
225681	202	226032	265	226262	446	226510	316	226772	44
225694	1	226032	344	226263	292	226510	398	226772	47
225706	72	226037	295	226263	372	226510	460	226787	297
225727	260	226040	275	226263	446	226512	316	226787	377
225746	37	226040	351	226269	325	226512	398	226787	449
225806	260	226041	275	226269	414	226512	460	226788	297
225817	260	226041	351	226269	466	226513	316	226788	379
225821	260	226050	305	226273	313	226513	398	226789	303
225825	260	226050	454	226273	395	226513	460	226789	383
225833	63	226050	386	226273	458	226516	304	226789	451
0225866	72	226054	305	226274	313	226516	385	226790	263
0225866	77	226054	386	226274	395	226516	453	226790	341
0225867	72	226054	454	226274	458	226517	304	226790	429
0225867	77	226056	305	226285	325	226517	385	226901	392
0225868	72	226056	389	226286	325	226517	453	226913	336
0225868	77	226056	454	226286	414	226524	310	226913	425
0225869	72	226057	310	226286	466	226524	392	226917	337
0225869	77	226057	395	226305	310	226524	457	226917	425
0225870	72	226057	457	226305	395	226526	304	226918	337
0225870	77	226058	264	226305	457	226526	385	226918	425
0225873	72	226059	264	226306	267	226526	453	226953	332
0225873	77	226065	325	226306	431	226527	298	226955	332
0225878	72	226065	412	226309	310	226527	379	226960	314
0225878	77	226065	465	226309	392	226527	450	226960	398
0225881	76	226066	325	226309	457	226544	298	226960	459
225918	36	226066	412	226321	271	226544	379	226961	314
225919	37	226066	465	226321	282	226572	304	226961	398

NUMERICAL INDEX

Part No.	Page	Part No.	Page	Part No.	Page	Part No.	Page	Part No.	Page
226961	459	227656	355	227796	285	227850	285	228056	453
226983	336	227656	437	227796	364	227850	362	228061	297
226983	424	227657	277	227796	441	227850	441	228063	297
226984	335	227657	355	227797	285	227851	285	228064	297
226984	423	227657	437	227797	364	227851	362	228065	296
227275	391	227660	317	227797	441	227851	441	228066	296
227275	456	227660	400	227798	286	227852	276	228069	317
227286	391	227660	461	227798	364	227852	351	228069	400
227286	456	227664	330	227798	442	227852	436	228069	461
227287	391	227665	330	227799	286	227853	276	228090	297
227288	391	227666	330	227799	364	227853	351	228091	297
227288	456	227667	330	227799	442	227853	436	228094	317
227289	391	227670	330	227807	313	227878	365	228094	399
227289	456	227671	330	227819	330	227878	443	228094	461
227290	391	227672	330	227820	330	227886	281	228095	317
227290	456	227673	326	227821	330	227886	360	228095	399
227291	326	227700	276	227822	330	227886	439	228095	461
227292	317	227700	352	227824	281	227887	278	228121	325
227370	330	227700	436	227825	281	227887	356	228121	412
227371	355	227701	278	227826	281	227887	438	228121	465
227371	437	227701	356	227827	281	227888	360	228127	314
227385	278	227702	278	0227830	281	227888	439	228127	398
227385	356	227703	278	0227830	359	227893	281	228127	459
227385	438	227704	285	0227830	439	227893	360	228128	459
227453	303	227704	364	0227831	281	227893	439	228129	314
227453	384	227704	442	0227831	359	227894	281	228129	398
227453	452	227705	286	0227831	439	227894	360	228129	459
227457	329	227705	364	227839	283	227894	384	228130	297
227461	330	227705	442	227839	360	227894	439	228130	459
227462	330	227710	282	227839	439	227897	360	228135	316
227463	330	227711	282	227840	278	227897	439	228135	398
227500	384	227720	282	227840	352	227899	295	228135	460
227500	452	227721	291	227840	436	227899	375	228137	316
227514	360	227723	330	227841	278	227899	448	228137	398
227514	440	227738	292	227841	352	227900	295	228137	459
227515	360	227738	371	227841	436	227900	375	228139	314
227515	440	227738	446	227842	275	227900	448	228139	398
227518	272	227739	292	227842	285	227914	425	228139	459
227518	349	227739	371	227842	350	227914	471	228142	316
227518	434	227739	446	227842	362	227915	330	228142	398
227519	272	227754	317	227842	435	227915	360	228142	460
227519	349	227754	400	227842	441	227915	440	228143	316
227519	434	227754	461	227843	275	227917	330	228143	398
227576	282	227755	317	227843	285	227918	330	228143	460
227576	360	227755	400	227843	350	227927	297	228144	338
227576	439	227755	461	227843	362	227927	379	228144	427
227579	317	227756	317	227843	435	227976	339	228144	472
227579	400	227765	318	227843	441	227984	303	228145	301
227579	462	227765	405	227844	277	227984	453	228145	380
227600	456	227765	462	227845	277	227991	303	228145	451
227619	330	227767	326	227846	286	227991	384	228147	380
227621	318	227780	329	227846	364	227991	453	228147	301
227631	297	227786	303	227846	442	228051	303	228147	451
227631	377	227786	383	227847	286	228051	383	228149	316
227631	449	227786	452	227847	364	228051	451	228149	398
227646	318	227795	285	227847	442	228055	384	228149	460
227647	318	227795	364	227848	277	228055	453	228154	297
227656	277	227795	441	227849	277	228056	384	228155	310

NUMERICAL INDEX

Part No.	Page	Part No.	Page	Part No.	Page	Part No.	Page	Part No.	Page
228155	392	228239	436	0228509	58	229282	455	229705	469
228155	457	228239	441	0228510	58	229284	301	229706	332
228156	310	228239	442	0228511	62	229284	380	229706	420
228156	392	228246	267	228514	20	229284	451	229715	422
228156	457	228246	346	228517	162	229302	25	229715	469
228157	310	228246	432	228519	162	229302	57	229748	334
228157	392	228251	267	228526	24	229302	329	229760	334
228157	457	228251	346	228527	20	229302	417	229773	332
228158	310	228251	432	228548	72	229324	278	229775	332
228158	392	228260	267	228617	23	229324	306	229775	420
228158	457	228260	346	228644	102	229324	356	229777	425
228168	297	228260	432	228675	111	229324	389	229790	334
228169	296	228272	278	228676	59	229324	438	229807	310
228174	297	228272	306	228676	70	229324	455	229807	395
228175	297	228272	356	228731	201	229340	267	229807	457
228177	317	228272	389	228732	201	229340	346	229808	310
228177	399	228272	438	228733	201	229340	432	229808	395
228177	461	228272	454	228734	201	229346	326	229808	457
228181	397	228284	267	228735	201	229354	275	229865	287
228196	301	228284	346	228754	56	229392	314	229865	366
228196	380	228284	432	228755	56	229392	398	229865	444
228196	451	228311	310	0228769	144	229392	459	229866	287
228197	301	228311	392	0228773	117	229393	314	229866	366
228197	380	228312	310	228787	144	229393	398	229866	444
228197	451	228312	392	228788	144	229393	459	229922	275
228203	360	228312	457	228827	147	229413	296	229923	275
228203	440	228313	310	228849	1	229415	296	229924	275
228232	330	228313	392	228850	25	229433	369	229925	275
228237	295	228314	310	228882	36	229433	445	229926	275
228237	374	228314	392	228886	36	229440	400	229927	275
228237	448	228314	457	228887	36	229440	461	229930	275
228238	275	228320	337	228895	154	229441	400	229931	275
228238	276	228320	426	228896	154	229441	461	229932	295
228238	277	228320	471	228899	154	229499	301	229972	57
228238	278	228321	314	228902	3	229549	332	229973	57
228238	285	228329	313	228939	329	229569	422	229986	270
228238	286	228329	396	228939	417	229569	469	229986	348
228238	350	228329	458	229223	282	229576	339	229986	433
228238	351	228330	278	229223	360	229576	427	229987	270
228238	352	228330	356	229223	440	229576	472	229987	348
228238	362	228330	437	229224	282	229577	336	229987	433
228238	364	228352	316	229224	360	229577	471	229988	270
228238	435	228375	276	229224	440	229578	336	229988	348
228238	436	228375	352	229250	316	229578	425	229988	434
228238	441	228375	436	229250	399	229578	471	229989	270
228238	442	228399	313	229255	58	229579	336	229989	348
228239	275	228405	334	229255	65	229579	425	229989	434
228239	276	228405	423	229261	303	229579	471	229996	275
228239	277	228405	470	229261	457	229585	333	229996	283
228239	278	228406	336	229262	318	229585	420	229996	350
228239	285	228406	423	229273	305	229593	317	229996	361
228239	286	228406	425	229273	386	229593	400	229996	435
228239	350	228406	470	229273	454	229593	462	229996	441
228239	351	228406	471	229274	305	229595	317	229997	275
228239	352	228407	339	229274	386	229595	399	229997	283
228239	362	228407	427	229274	454	229595	460	229997	350
228239	364	228446	338	229282	306	229705	333	229997	361
228239	435	228446	427	229282	390	229705	420	0230031	317

NUMERICAL INDEX

Part No.	Page	Part No.	Page	Part No.	Page	Part No.	Page	Part No.	Page
0230032	317	230537	286	231312	50	231480	54	231568	351
0230033	317	230537	364	231312	55	231481	259	231569	276
0230034	317	230537	442	231313	50	231482	49	231569	351
0230041	317	230554	285	231313	55	231482	53	231571	313
0230046	318	230554	364	231318	214	231483	49	231599	316
0230048	317	230554	441	231319	117	231483	54	231599	398
0230049	317	230555	276	231330	194	231484	49	231600	309
0230050	317	230555	352	231331	194	231484	54	231601	309
0230051	317	230555	436	231334	49	231486	185	231604	267
0230052	317	230556	285	231334	54	231489	49	231605	267
0230053	317	230556	364	231335	49	231489	53	231606	267
0230054	317	230556	441	231335	54	231491	50	231607	267
0230060	57	230562	296	231365	222	231491	55	231610	267
0230060	63	230563	296	231372	41	231496	20	231611	267
230068	24	230578	270	231373	41	231498	101	231620	305
230176	42	230578	348	231374	41	231499	217	231620	386
230179	184	230578	433	231375	41	231519	295	231621	305
230182	3	230579	270	231380	183	231526	290	231621	386
230183	3	230579	348	231403	42	231526	369	231622	285
230207	1	230579	433	231404	42	231527	290	231623	285
230219	185	230586	330	231405	42	231527	369	231624	43
230222	147	230587	330	231406	42	231528	290	231625	43
230232	153	230588	271	231414	50	231528	371	231626	43
230233	153	230588	282	231415	50	231528	446	231627	43
230234	147	230588	349	231419	101	231529	290	231631	290
230235	147	230588	360	231421	100	231529	371	231631	369
230237	147	230588	434	231422	85	231529	446	231631	446
230238	148	230588	440	231423	84	231536	321	231632	290
230239	153	230590	276	231424	49	231536	463	231632	369
230240	153	230590	352	231424	54	231537	321	231632	445
230241	53	230590	436	231425	49	231537	463	231635	292
230241	147	230591	276	231425	54	231541	62	231635	371
230246	155	230591	352	231426	218	231541	70	231635	446
230278	102	230591	436	231428	222	231549	43	231638	283
230292	147	0231028	207	231432	218	231550	43	231639	283
230297	102	231032	10	231438	182	231551	391	231640	283
230298	102	231044	185	231438	186	231551	456	231641	283
230299	102	0231092	3	231439	218	231552	277	231642	283
230304	148	0231093	3	231441	51	231552	355	231643	283
230305	183	231138	37	231441	55	231552	437	231655	316
230306	183	231152	199	231442	184	231553	277	231657	322
230307	183	231153	199	231444	176	231553	355	231660	295
230345	27	231154	194	231447	217	231553	437	231660	374
230362	184	231157	37	231448	51	231554	272	231660	447
230363	184	231157	38	231448	55	231554	349	231661	295
230364	184	231158	199	231449	51	231554	435	231661	374
230365	184	231159	199	231449	56	231555	272	231661	448
230367	184	231160	199	231456	184	231555	349	231683	310
230378	185	0231176	181	231457	184	231555	435	231687	290
0230399	207	231181	210	231462	184	231556	272	231687	369
230427	164	231181	214	231463	184	231556	349	231687	445
230429	184	231182	210	231468	184	231556	435	231705	326
230438	56	231182	214	231471	185	231557	272	231711	290
230450	182	231183	214	231472	185	231557	349	231711	369
230455	155	231184	214	231477	53	231557	435	231711	445
230536	286	231297	34	231478	53	231558	295	231713	290
230536	364	231300	62	231479	48	231559	297	231713	369
230536	442	231310	199	231480	49	231568	276	231713	445

NUMERICAL INDEX

Part No.	Page	Part No.	Page	Part No.	Page	Part No.	Page	Part No.	Page
231715	290	231769	386	231970	270	232044	211	232228	62
231715	369	231770	303	231970	348	232045	211	232232	56
231715	445	231770	383	231970	433	232046	99	232233	13
231736	290	231800	265	231971	270	232048	49	232234	13
231736	369	231800	343	231971	348	232048	53	232236	13
231737	290	231800	430	231971	433	232049	49	232236	19
231737	369	231801	265	231972	270	232049	53	232237	13
231738	290	231801	343	231972	348	232052	181	232237	19
231738	371	231801	430	231972	433	232053	181	232240	72
231738	446	231804	265	231973	270	232055	184	232241	72
231739	290	231804	343	231973	348	232058	181	232242	72
231739	371	231804	430	231973	433	232060	49	232243	72
231739	446	231805	265	231975	263	232060	52	232244	72
231740	290	231805	343	231975	341	232063	181	232245	72
231740	369	231805	431	231975	429	232064	147	232246	72
231741	290	231806	265	231976	270	232068	181	232247	82
231741	369	231806	343	231976	348	232072	181	232248	75
231742	290	231806	430	231976	433	232073	56	232248	82
231742	369	231808	265	231982	361	232074	56	232250	73
231742	446	231814	265	231982	441	232121	56	232250	80
231743	290	231814	344	231986	325	232125	117	232251	75
231743	369	231815	265	231986	414	232127	93	232251	82
231743	446	231815	344	231986	466	232129	181	232252	72
231744	290	231817	392	231989	325	232132	177	232252	77
231744	371	231817	456	231989	414	232133	176	232253	72
231744	446	231818	290	231989	466	232134	112	232254	72
231745	290	231818	369	231991	292	232139	177	232256	73
231745	371	231820	271	231991	372	232144	205	232256	80
231745	446	231820	349	231991	447	232144	206	232257	82
231746	290	231820	434	232000	48	232149	112	232258	75
231746	371	231821	271	232001	48	232150	146	232258	82
231746	446	231821	349	232002	49	232152	176	232259	73
231747	290	231821	360	232002	53	232153	180	232259	80
231747	371	231821	434	232003	48	232154	56	232260	73
231747	446	231821	440	232003	53	232164	147	232260	80
231756	292	231864	283	232006	51	232165	85	232262	27
231756	371	231865	283	232006	55	232166	85	232263	27
231756	446	231866	283	232007	51	232172	4	232264	11
231758	292	231867	283	232007	55	232173	4	232265	11
231758	371	231890	265	232008	154	232178	49	232266	11
231758	446	231890	343	232011	154	232179	49	232267	11
231760	305	231890	430	232015	50	232190	4	232268	11
231760	386	231891	265	232015	54	232190	5	232274	259
231761	305	231891	343	232016	50	232193	42	232275	23
231761	386	231891	430	232016	54	232194	42	232276	23
231762	285	231937	325	232019	49	232197	42	232277	23
231763	285	231937	414	232019	53	232201	28	232278	23
231764	276	231937	466	232020	10	232202	28	232280	56
231764	351	231938	325	232024	218	232203	28	232285	28
231765	276	231938	414	232025	218	232210	38	232287	28
231765	351	231938	466	232027	117	232220	39	232288	56
231766	276	231955	310	232032	48	232221	39	232292	176
231766	351	231966	278	232032	53	232222	39	232299	56
231767	276	231966	356	232034	183	232223	40	232300	56
231767	351	231966	437	232036	49	232224	59	232303	49
231768	305	231967	278	232036	53	232225	59	232304	49
231768	386	231967	356	232039	218	232226	57	232308	40
231769	305	231967	437	232040	218	232227	62	232309	48

NUMERICAL INDEX

Part No.	Page	Part No.	Page	Part No.	Page	Part No.	Page	Part No.	Page
232311	48	232398	19	232572	25	232707	50	232895	181
232312	49	232399	13	232582	148	232707	54	232898	181
232313	49	232399	19	232585	25	232708	50	232918	48
232314	49	232400	50	232590	214	232708	54	232918	52
232315	49	232401	50	232601	27	232709	50	232919	57
232316	5	0232404	14	232604	218	232709	54	232920	329
232317	5	0232405	17	232604	259	232720	259	232921	329
232318	5	0232406	18	232605	258	232722	258	232924	145
232319	5	0232406	20	232608	37	232723	258	232925	37
232320	5	0232407	14	232623	20	232725	26	232960	194
232321	55	0232407	19	232624	49	232726	37	232962	258
232324	27	0232409	14	232624	54	232731	10	232966	218
232327	62	0232409	20	232625	147	232736	214	232968	218
232328	59	232410	53	232630	53	232737	214	232969	218
0232329	57	232411	53	232631	53	232738	214	232979	8
0232330	58	232422	101	232632	53	232739	35	232999	222
0232331	63	232455	145	232633	53	232740	214	233010	333
0232332	63	0232456	14	232636	50	232742	211	233010	421
0232333	58	0232457	14	232636	54	232747	210	233010	469
0232334	58	232460	210	232637	50	232748	210	233011	333
0232335	58	232461	210	232637	54	232749	210	233011	421
232340	26	232462	210	232638	50	232750	210	233011	469
232342	56	232468	148	232638	54	232753	48	233012	333
232345	56	232471	10	232639	50	232754	40	233012	421
232346	56	232472	11	232639	54	232759	258	233012	469
232347	56	232476	210	232640	51	232763	258	233013	333
232348	56	232482	25	232640	55	232771	99	233013	421
232349	56	232484	6	232641	51	232778	209	233013	469
232350	56	232485	26	232641	55	232779	209	233014	333
232357	27	232486	26	232642	51	232780	209	233014	421
232358	39	232487	56	232642	55	232791	46	233014	469
232359	41	232490	25	232643	51	232791	209	233015	333
232362	62	232491	219	232643	55	232796	37	233015	421
232363	44	232492	26	232645	164	232806	183	233015	469
232365	6	232494	218	232646	222	232807	183	233016	333
232368	25	232500	25	232648	164	232829	39	233016	421
232369	10	232502	209	232654	148	232840	183	233016	469
232370	11	232503	209	232659	153	232841	183	233017	333
232371	11	232504	26	232671	8	232841	186	233017	421
232372	11	232505	219	232671	137	232847	20	233017	469
232373	11	232508	53	232676	199	232850	35	233018	333
232374	11	232509	53	232677	219	232850	39	233018	421
232375	11	232511	209	232678	219	232850	40	233018	469
232376	11	232517	211	232679	219	232855	4	233019	333
232377	11	232518	211	232680	219	232856	35	233019	421
232378	57	232544	201	232681	219	232856	39	233019	469
232378	64	232545	201	232682	219	232856	40	233020	334
232381	57	232546	201	232686	219	232865	23	233020	422
232381	64	232547	201	232688	40	232866	23	233020	469
232385	59	232548	43	232690	48	232869	23	233021	334
232390	211	232549	43	232692	148	232870	23	233021	422
232393	13	0232552	14	232700	204	232871	23	233021	469
232394	13	0232553	14	232700	207	232873	23	233022	334
232395	13	0232554	17	232701	204	232874	23	233022	422
232396	13	0232555	14	232701	207	232875	23	233022	469
232397	13	0232556	17	232705	258	232880	37	233023	334
232397	19	0232557	14	232706	50	232880	112	233023	422
232398	13	0232558	17	232706	54	232893	180	233023	469

NUMERICAL INDEX

Part No.	Page	Part No.	Page	Part No.	Page	Part No.	Page	Part No.	Page
233024	334	233109	335	233269	424	233487	332	233591	331
233025	334	233109	419	233278	332	233487	420	233591	419
233026	333	233109	468	233278	420	233489	334	233596	335
233026	470	233112	292	233279	332	233490	331	233596	419
233027	333	233113	292	233280	332	233491	331	233596	468
233028	333	233113	372	233280	420	233492	331	233619	332
233029	333	233113	446	233281	332	233493	332	233619	420
233030	333	233126	335	233281	420	233494	331	233619	469
233031	333	233126	419	233294	296	233496	296	233624	337
233032	333	233126	468	233298	334	233514	333	233624	425
233033	333	233164	332	233299	339	233514	420	233628	335
233034	333	233165	332	233299	427	233514	469	233628	424
233034	421	233166	332	233299	472	233515	333	233656	331
233035	333	233167	332	233314	309	233515	420	233656	419
233035	421	233194	264	233315	309	233515	469	233657	419
233039	309	233194	342	233316	309	233524	296	233659	331
233039	391	233194	430	233350	264	233528	314	233680	376
233040	309	233195	342	233350	342	233528	398	233681	376
233040	391	233195	264	233350	430	233528	459	233682	376
233041	309	233195	430	233351	264	233534	335	233683	376
233041	391	233196	264	233351	342	233534	419	233684	377
233042	296	233196	343	233351	430	233540	331	233685	376
233042	376	233196	430	233352	336	233540	419	233686	377
233043	296	233197	264	233352	424	233541	331	233687	376
233043	376	233197	343	233352	470	233541	419	233708	376
233044	296	233197	430	233353	334	233542	331	233719	383
233045	296	233198	264	233353	423	233542	419	233719	452
233046	296	233198	343	233353	470	233543	331	233720	342
233046	376	233198	430	233354	335	233543	420	233721	342
233046	449	233199	264	233354	423	233544	332	233722	342
233047	297	233199	343	233354	470	233544	420	233723	342
233047	377	233199	430	233355	339	233545	332	233724	342
233047	449	233200	265	233355	427	233545	420	233725	342
233048	377	233200	343	233355	472	233546	332	233726	342
233048	449	233200	430	233356	335	233546	420	233727	342
233049	296	233201	265	233356	424	233547	332	233728	342
233049	376	233201	343	233356	470	233547	420	233729	342
233049	449	233201	430	233382	270	233548	332	233740	421
233050	331	233202	265	233382	384	233548	420	233741	421
233051	331	233202	343	233382	433	233549	332	233742	421
233052	331	233202	430	233383	270	233549	420	233743	421
233052	419	233203	265	233383	348	233550	332	233744	421
233053	331	233203	343	233383	433	233550	420	233745	421
233053	419	233203	430	233384	270	233551	332	233746	421
233054	331	233205	335	233384	348	233551	420	233747	421
233054	419	233205	424	233384	433	233552	332	233750	422
233055	331	233205	470	233385	270	233552	420	233751	422
233056	331	233206	335	233385	348	233553	332	233752	422
233057	331	233206	424	233385	433	233553	420	233753	422
233058	331	233264	335	233386	292	233555	293	233754	422
233058	419	233264	419	233387	292	233571	301	233755	422
233059	331	233264	468	233387	372	233571	380	233756	372
233088	334	233265	335	233387	446	233588	331	233757	372
233089	334	233265	424	233392	264	233588	419	233760	422
233090	334	233267	336	233393	264	233589	331	233760	469
233091	334	233267	424	233472	427	233589	419	233761	422
233092	334	233267	470	233472	339	233590	331	233762	422
233093	334	233269	336	233472	472	233590	419	233762	469

NUMERICAL INDEX

Part No.	Page	Part No.	Page	Part No.	Page	Part No.	Page	Part No.	Page
233763	422	234578	10	0234759	19	234870	6	234990	23
233763	469	234579	10	234760	13	234872	6	234993	50
233764	422	234584	85	234768	260	234873	6	234993	55
233764	469	234585	85	234768	262	234874	6	234994	262
233765	422	234601	85	234772	10	234875	6	235022	361
233765	469	234606	10	234773	10	234876	6	235022	441
233766	422	234608	218	234785	260	234885	8	235029	350
233766	469	234630	262	0234786	17	234886	4	235029	435
233767	422	234637	35	0234786	19	234890	36	235042	270
233767	469	234638	262	0234787	17	0234891	58	235042	282
233768	423	234639	261	0234787	20	234892	13	235042	348
233768	470	234640	261	0234788	17	234892	19	235042	360
233780	391	234645	37	0234788	19	234894	2	235042	433
233781	391	234646	4	0234789	18	234895	3	235042	439
233782	391	234649	2	0234789	19	234899	262	235046	270
233797	425	234650	2	0234790	6	234900	43	235046	282
233797	471	234651	2	0234791	17	234900	46	235046	348
233798	372	234652	2	0234791	19	234902	43	235046	360
233798	447	234653	13	0234792	18	234903	43	235046	433
233799	425	234653	19	0234792	19	234917	147	235046	439
233799	471	234654	199	0234793	17	234925	38	235061	292
233841	376	234655	199	0234793	20	234926	259	235061	371
233846	376	234656	199	0234794	13	234928	147	235061	446
233853	424	234678	14	0234794	19	234929	259	235082	263
233853	471	234678	19	0234795	14	234931	8	235082	341
233927	419	234684	118	234796	13	234932	8	235082	429
233939	423	234686	260	234815	9	234933	24	235095	318
233940	424	0234693	14	234816	10	234934	8	235095	406
233985	419	0234693	20	234817	10	234936	163	235096	318
233986	419	0234694	17	234825	8	234938	23	235096	406
233991	420	0234694	19	234830	10	234939	101	235096	463
233992	420	0234696	17	234831	10	234942	8	235097	321
234505	222	0234696	20	234832	10	234943	1	235100	271
234511	222	0234697	17	234833	10	234944	49	235100	349
234512	222	0234697	19	234834	9	234944	53	235100	434
234522	205	234704	42	234838	94	234946	24	235102	267
234522	206	234705	42	234838	177	234949	23	235102	344
234524	204	234706	42	234840	94	234950	20	235108	321
234524	207	234707	42	234845	6	234955	41	235108	406
234525	204	234708	43	234846	6	234956	41	235108	463
234525	207	234709	43	234847	6	234957	41	235124	289
234529	209	234710	43	234848	6	234958	41	235125	289
234530	209	234711	43	234849	6	234960	261	235126	289
234536	40	234712	43	234850	6	234961	261	235128	316
234537	40	234713	43	234851	6	234962	261	235128	398
234540	219	234714	43	234852	6	234963	261	235128	460
234541	219	234721	34	234853	262	234964	8	235141	271
234542	219	234721	38	234855	34	234966	148	235141	349
234543	219	234729	10	234857	42	234968	20	235141	434
234550	219	234731	222	0234858	58	234974	43	235147	325
234551	219	234735	194	234861	6	234974	46	235147	414
234557	258	234740	148	234862	6	234975	329	235147	466
234558	219	234741	14	234863	6	234975	417	235155	289
234560	214	234741	19	234864	6	234975	467	235156	283
234561	214	234748	209	234865	6	234980	43	235157	283
234569	34	234756	9	234866	6	234981	43	235158	283
234570	35	0234758	17	234867	6	234984	24	235159	283
234573	35	0234758	19	234868	6	234985	24	235160	289
234577	10	0234759	18	234869	6	234986	23	235161	289

507
pg 224

NUMERICAL INDEX

Part No.	Page	Part No.	Page	Part No.	Page	Part No.	Page	Part No.	Page
235161	366	235255	349	235354	445	235444	396	0235490	269
235161	444	235255	434	235355	290	235444	458	0235491	269
235162	289	235258	337	235355	369	235445	314	0235492	269
235164	321	235258	426	235355	446	235445	396	0235493	269
235164	463	235259	337	235359	263	235445	458	0235494	269
235165	321	235259	425	235359	341	235446	313	0235495	269
235165	463	235260	337	235359	429	235446	396	0235496	269
235166	277	235260	425	235360	58	235446	458	0235497	269
235166	355	235262	267	235361	58	235447	314	0235498	269
235166	437	235262	431	235362	295	235447	396	0235499	269
235167	277	235263	267	235363	295	235447	458	0235500	269
235167	355	235263	431	235364	297	235448	313	0235501	301
235167	437	235264	267	235365	297	235448	396	0235502	301
235168	286	235264	431	235371	58	235448	458	0235503	301
235168	364	235265	267	235397	341	235449	314	0235504	301
235168	442	235266	267	235397	263	235449	396	235505	329
235169	286	235266	431	235397	429	235449	458	235511	396
235169	364	235268	337	235397	430	235450	313	235511	458
235169	442	235268	426	235401	275	235450	396	235514	301
235175	289	235269	431	235402	275	235450	458	235514	451
235175	366	235270	431	235403	283	235451	314	235534	271
235175	444	235271	431	235406	275	235451	396	235534	282
235176	321	235279	314	235407	275	235451	458	235535	271
235176	409	235279	398	235407	283	235453	276	235544	271
235176	464	235279	459	235408	283	235456	321	235544	282
235177	321	235304	321	235409	58	0235457	268	235545	271
235177	409	235304	409	235410	58	0235458	268	235545	282
235177	464	235304	464	235411	58	0235459	268	235559	270
235181	322	235305	321	235416	263	0235460	268	235559	348
235181	409	235305	409	235416	341	0235461	268	235559	433
235183	330	235305	464	235416	429	0235462	268	0235560	318
235186	265	235306	321	235419	263	0235463	268	0235561	318
235186	343	235306	406	235419	341	0235464	268	0235562	318
235186	430	235306	464	235419	429	0235465	268	0235563	317
235187	265	235307	321	235420	321	0235466	268	0235564	318
235187	343	235307	409	235420	409	0235467	268	0235565	318
235187	430	235307	464	235420	464	0235468	268	0235566	318
235190	321	235329	458	235423	444	0235469	268	0235567	318
235190	409	235336	298	235423	366	0235470	268	235605	344
235191	321	235337	298	235423	287	0235471	268	235605	431
235191	409	235338	298	235428	322	0235472	268	235611	418
235192	265	235339	298	235430	296	0235473	268	235611	468
235193	265	235340	298	235432	296	0235474	268	235620	361
235221	330	235340	380	235433	296	0235475	268	235620	440
235222	316	235340	450	235434	272	0235476	268	235621	361
235222	398	235341	301	235434	283	0235477	269	235621	440
235222	460	235341	380	235434	325	0235478	269	235622	350
235226	392	235341	450	235440	313	0235479	269	235622	435
235226	457	235344	313	235440	396	0235480	269	235628	360
235227	265	235344	396	235441	313	0235481	269	235628	440
235243	317	235344	458	235441	396	0235482	269	235629	360
235244	317	235347	330	235442	313	0235483	269	235629	440
235244	399	235348	314	235442	396	0235484	269	235630	361
235244	461	235348	398	235442	458	0235485	269	235630	440
235245	317	235348	459	235443	314	0235486	269	235631	361
235245	399	235349	290	235443	396	0235487	269	235631	440
235245	461	235354	290	235443	458	0235488	269	235640	362
235255	271	235354	369	235444	313	0235489	269	235641	362

NUMERICAL INDEX

Part No.	Page	Part No.	Page	Part No.	Page	Part No.	Page	Part No.	Page
235646	362	235740	448	235800	349	235929	418	236007	271
235647	362	235741	377	235800	360	235930	409	236008	272
235648	362	235741	449	235802	349	235931	395	236009	271
235649	362	235746	391	235802	360	235932	350	236010	272
235650	362	235746	456	235808	379	235933	351	236011	271
235651	362	235747	391	235808	450	235934	350	236012	277
235656	359	235747	456	235809	379	235935	350	236012	355
235656	439	235748	391	235821	414	235936	386	236012	360
235657	359	235748	456	235821	466	235937	386	236012	364
235657	439	235749	414	235822	414	235938	386	236012	437
235667	418	235749	466	235822	466	235939	386	236012	439
235667	468	235750	344	235824	414	235940	386	236012	442
235670	64	235750	431	235824	466	235941	386	236014	277
235671	64	235751	418	235825	414	235942	383	236014	355
235678	417	235751	468	235825	466	235943	412	236014	437
235678	467	235754	346	235826	414	235944	351	236015	277
235679	447	235754	432	235826	466	235945	351	236015	355
235679	374	235756	346	235828	417	235946	418	236015	437
235680	374	235757	412	235828	467	235946	467	236016	276
235680	447	235757	465	235829	414	235947	414	236016	351
235681	374	235759	392	235829	466	235947	465	236017	276
235681	447	235759	457	235830	412	235956	271	236017	351
235690	409	235769	63	235830	465	235956	349	236018	276
235690	464	235770	460	235841	399	235956	434	236018	351
235691	412	235771	351	235842	368	235958	350	236019	276
235691	465	235771	362	235846	368	235958	435	236019	351
235696	409	235771	383	235847	395	235959	350	236022	318
235696	464	235771	386	235848	359	235959	435	236023	318
235698	418	235771	395	235848	390	235960	392	236024	317
235698	468	235771	418	235849	359	235960	457	236024	400
235699	418	235771	436	235849	390	235961	406	236024	461
235699	468	235771	441	235849	395	235961	463	236025	317
235700	412	235771	452	235854	359	235962	406	236025	400
235701	70	235771	454	235854	390	235963	406	236025	461
235702	412	235771	457	235856	406	235969	419	236026	290
235702	465	235771	467	235857	406	235969	468	236026	371
235704	409	235772	379	235858	406	235970	377	236026	446
235704	464	235773	379	235859	406	235970	449	236027	290
235705	418	235773	450	235860	418	235971	377	236027	371
235705	467	235774	417	235860	468	235971	449	236027	446
235706	418	235774	467	235861	417	235972	375	236028	390
235706	467	235776	47	235862	418	235972	448	236028	456
235708	418	235777	47	235863	64	235973	375	236029	390
235708	468	235778	47	235870	346	235973	448	236029	456
235709	418	235779	47	235872	412	235975	414	236033	295
235709	468	235780	47	235872	465	235975	465	236038	283
235710	418	235781	47	235878	346	236001	276	236038	361
235710	467	235782	47	235880	375	236001	352	236038	440
235711	418	235783	47	235881	375	236001	436	236039	283
235711	467	235791	346	235882	414	236002	277	236039	361
235720	412	235791	432	235882	466	236002	352	236039	440
235720	465	235792	346	235884	344	236002	436	236040	272
235722	65	235792	431	235885	344	236003	277	236040	349
235724	412	235793	406	235886	392	236003	352	236040	435
235728	399	235796	368	235887	409	236003	436	236041	272
235729	399	235797	368	235888	409	236004	272	236041	349
235730	399	235798	395	235889	395	236005	271	236041	435
235740	375	235799	395	235928	417	236006	272	236044	275

NUMERICAL INDEX

Part No.	Page	Part No.	Page	Part No.	Page	Part No.	Page	Part No.	Page
236045	275	236166	318	236633	399	236710	317	236780	420
236046	283	236166	405	236633	461	236711	326	236780	469
236047	283	236166	462	236636	276	236712	326	236781	337
236057	296	236167	318	236636	352	236714	329	236781	419
236057	376	236167	405	236636	436	236715	330	236782	310
236057	449	236167	462	236637	276	236716	272	236782	392
236059	330	236172	317	236637	352	236716	349	236782	457
236060	270	236173	317	236637	436	236716	435	236783	309
236060	348	236174	317	236638	317	236717	272	236783	391
236060	434	236175	317	236640	318	236717	349	236783	456
236061	330	236177	391	236641	318	236717	435	236784	296
236061	348	236177	456	236642	318	236728	272	236784	375
236061	434	236178	275	236643	318	236728	349	236784	448
236062	270	236178	351	236653	267	236728	434	236785	296
236062	330	236179	275	236653	431	236729	272	236785	375
236062	348	236179	351	236661	317	236729	349	236785	449
236062	433	236180	275	236661	399	236729	434	236786	297
236069	317	236180	351	236661	460	236730	384	236786	377
236069	400	236181	276	236662	318	236730	453	236786	449
236069	462	236181	351	236663	318	236731	384	236787	297
236078	282	236182	285	236664	303	236731	453	236787	377
236078	360	236182	362	236665	303	236732	270	236787	449
236078	439	236183	285	236665	383	236732	348	236788	309
236079	282	236183	362	236665	452	236732	433	236788	391
236079	360	236184	285	236668	303	236733	270	236788	456
236079	439	236184	362	236668	383	236733	348	236789	309
236080	282	236185	285	236668	452	236733	433	236789	391
236080	360	236185	362	236669	303	236736	376	236789	456
236080	440	236196	277	236669	383	236743	337	236793	366
236081	282	236196	352	236669	452	236743	420	236793	443
236081	360	236196	436	236670	384	236744	309	236794	366
236081	440	236197	277	236670	452	236744	391	236794	443
236102	330	236197	352	236671	384	236744	456	236811	335
236103	330	236197	436	236671	452	236745	309	236812	337
236104	318	236304	317	236673	318	236745	391	236816	337
236104	405	236325	317	236673	405	236745	456	236826	271
236104	462	236325	400	236673	462	236746	297	236827	271
236105	318	236325	462	236676	318	236747	310	236828	271
236105	405	236386	317	236677	318	236747	392	236829	271
236105	462	236419	317	236686	290	236747	457	236830	282
236106	318	236536	400	236686	371	236748	309	236831	282
236106	405	236537	400	236686	446	236748	391	236832	271
236106	462	236619	326	236687	292	236748	456	236833	271
236107	318	236622	399	236687	371	236760	383	236834	271
236107	405	236623	399	236687	446	236762	383	236835	272
236107	462	236624	317	236688	270	236764	383	236836	282
236108	318	236624	399	236688	348	236765	383	236837	282
236108	405	236624	461	236688	433	236766	383	236853	400
236108	462	236625	317	236690	405	236767	383	236853	462
236109	318	236625	399	236690	462	236773	390	236854	399
236109	405	236625	461	236691	405	236773	456	236854	461
236109	462	236627	276	236691	462	236776	317	236855	399
236110	275	236627	352	236698	326	236776	400	236855	461
236111	275	236627	436	236699	326	236776	462	236856	399
236132	405	236632	317	236701	326	236777	317	236856	461
236132	462	236632	399	236703	329	236777	400	236857	399
236133	405	236632	461	236706	326	236777	462	236857	461
236133	462	236633	317	236707	326	236780	337	236858	391

NUMERICAL INDEX

Part No.	Page	Part No.	Page	Part No.	Page	Part No.	Page	Part No.	Page
236858	456	236979	352	237079	203	237247	80	237358	53
236859	391	236979	437	237079	207	237249	23	237383	8
236859	456	236980	374	237089	259	237250	36	237386	6
236862	356	236980	448	237097	50	237251	36	237388	49
236862	438	236981	417	237097	55	237252	36	237388	53
236863	356	236981	467	237098	49	237257	222	237390	36
236863	438	236985	392	237109	75	237261	163	237391	36
236864	438	236985	456	237109	82	237271	58	237392	36
236866	418	236988	395	237110	75	237272	58	237393	73
236866	468	237002	12	237110	82	237275	63	237393	80
236868	418	237002	24	237111	73	237275	71	237394	73
236868	468	237004	25	237111	80	237286	218	237394	80
236869	418	237005	205	237112	73	237295	58	237395	73
236872	417	237005	207	237112	80	237295	63	237395	80
236875	418	237006	205	237113	73	237295	71	237396	73
236875	467	237006	207	237113	81	237297	111	237396	80
236880	418	237005	217	237114	73	237300	73	237402	12
236881	335	237008	26	237114	81	237300	80	237403	12
236882	418	237009	26	237120	209	237301	73	237404	12
236882	468	237010	26	237121	209	237301	81	237405	12
236883	418	237012	25	237130	62	237302	73	237406	13
236883	468	237013	25	237135	34	237302	80	237407	13
236884	418	237015	26	237136	34	237303	73	237408	12
236884	467	237016	12	237137	118	237303	81	237409	12
236885	335	237017	24	237138	164	237304	82	237410	12
0236900	359	237023	12	237139	118	237311	41	237411	12
0236900	439	237024	12	237164	258	237312	41	237412	12
0236901	359	237025	12	237166	118	237314	209	237413	12
0236901	439	237026	12	237173	23	237317	209	237414	12
0236902	359	237027	201	237174	20	237318	209	237420	182
0236902	439	237028	201	237177	24	237319	222	237421	182
0236903	359	237029	201	237179	24	237321	222	237424	49
0236903	439	237030	201	237180	23	237322	222	237424	52
236916	406	237031	201	237181	8	237325	222	237429	75
236916	463	237032	201	237183	20	237332	49	237429	82
236940	349	237033	201	237190	111	237332	53	237435	72
236940	361	237034	201	237192	4	237338	51	237435	77
236941	418	237035	201	237194	20	237338	55	237444	41
236941	468	237036	201	237194	23	237339	51	237449	39
236942	349	237037	20	237200	36	237339	55	237452	214
236942	361	237038	50	237201	27	237346	73	237456	40
236944	349	237045	262	237203	24	237346	81	237457	40
236946	349	237050	50	237205	102	237347	82	237458	40
236951	418	237050	55	237206	36	237348	75	237461	39
236970	418	237051	50	237209	102	237348	80	237463	6
236970	468	237051	55	237210	164	237350	51	237464	48
236971	418	237052	49	237213	28	237350	55	237464	53
236971	468	237054	259	237214	25	237351	51	237466	39
236974	384	237056	218	237215	24	237351	56	237467	39
236974	453	237058	219	237218	182	237352	51	237468	39
236975	384	237059	218	237219	176	237352	55	237469	39
236975	453	237060	218	237222	222	237353	51	237480	39
236976	352	237065	259	237227	222	237353	55	237484	9
236976	436	237066	259	237229	222	237354	48	237487	40
236977	352	237067	259	237244	215	237355	48	237488	40
236977	437	237075	12	237245	73	237356	48	237490	38
236978	352	237078	203	237245	80	237357	48	237491	49
236978	437	237078	207	237247	73	237358	49	237491	53

NUMERICAL INDEX

Part No.	Page	Part No.	Page	Part No.	Page	Part No.	Page	Part No.	Page
237505	20	237630	142	237841	48	239014	100	239174	48
237514	218	237631	143	237841	52	0239017	72	239174	52
237515	218	237632	143	237842	4	239023	23	239198	260
237516	37	237634	222	237843	48	0239027	207	239220	210
0237518	137	237635	50	237843	52	0239028	207	239221	210
237519	222	237635	54	237849	49	0239029	207	239222	210
237520	222	237640	210	237849	53	0239030	207	239223	204
237521	222	237641	210	237850	53	239031	195	239223	207
237529	52	237642	210	237877	9	239038	218	239224	204
237532	53	237643	210	237878	9	0239039	258	239224	207
237533	40	237642	211	237881	259	239040	72	239255	219
237534	51	237644	210	237882	27	239041	99	239256	219
237534	55	237645	210	237887	111	239044	222	239258	217
237535	51	237653	211	237889	9	0239048	57	239260	204
237535	55	237654	148	237890	9	0239055	62	239260	207
237536	51	237656	36	237891	9	0239056	214	239261	204
237536	55	0237657	117	237893	9	0239057	214	239261	207
237537	51	237660	194	237895	10	0239058	217	239300	219
237537	55	237673	142	237899	10	239059	9	239301	219
237540	48	237691	143	237902	84	239060	9	239302	219
237541	48	237694	100	237904	182	239061	24	0239303	214
237542	48	237695	100	237909	222	0239063	76	239304	144
237543	48	237696	100	237910	222	0239064	76	239311	205
237544	48	237697	100	237911	211	0239065	76	239311	207
237545	48	237698	100	237912	211	0239065	83	239312	205
237546	49	237699	100	237921	210	0239066	76	239312	207
237546	54	237700	143	237922	210	0239066	83	239320	112
237547	49	237701	143	237923	210	0239067	76	0239330	207
237547	54	237702	143	237924	210	0239067	83	239335	9
237548	49	237703	143	237925	210	0239076	137	0239340	261
237548	54	237704	143	237925	211	239078	205	0239341	261
0237549	214	237705	143	237926	210	239078	207	0239342	259
0237551	203	237706	143	237926	211	239079	205	0239343	259
237551	207	237707	143	237927	210	239079	207	0239344	261
237552	203	237708	143	237927	211	0239080	207	0239345	261
237552	207	237710	10	237929	210	0239082	72	0239346	261
237553	204	237711	10	237929	211	0239082	77	0239347	261
237553	205	237712	10	237930	210	0239083	72	239367	210
237553	207	237713	10	237930	211	0239084	72	239367	211
237554	204	237745	48	237931	210	0239086	9	239405	210
237554	205	237746	48	237932	210	0239087	9	239406	210
237554	207	237747	48	237933	210	239090	204	239407	142
237555	12	237750	199	237941	215	239090	207	239414	205
237556	24	237753	259	237942	50	239091	203	239414	207
237557	12	237756	215	237942	54	239091	207	239415	205
237557	24	237759	215	237945	215	239092	205	239415	207
237558	177	237803	9	237949	217	239092	207	239425	147
237560	40	237804	9	237954	37	239093	205	239436	153
237561	40	237805	9	237962	259	239093	207	239441	153
237563	86	0237811	85	237963	259	239105	35	239453	142
237564	86	0237812	85	237964	259	0239127	163	239454	142
237565	37	237813	222	237989	217	0239142	9	239455	144
237568	50	237814	222	237990	217	0239143	9	239468	147
237569	50	237816	9	237992	204	239147	210	239471	85
237570	50	237834	214	237992	205	239147	211	239472	210
237571	50	237836	25	237992	207	239169	38	239472	211
237618	6	237838	41	237993	205	239173	48	239473	147
237622	6	237839	41	237996	100	239173	52	239475	4

NUMERICAL INDEX

Part No.	Page	Part No.	Page	Part No.	Page	Part No.	Page	Part No.	Page
239477	210	239617	463	0239809	161	240052	156	240173	54
239478	210	239618	184	239811	111	240053	156	240174	54
0239494	207	239618	321	239822	46	240055	156	240175	54
0239495	207	0239642	93	239823	46	240060	180	240182	181
0239498	207	0239643	93	239825	56	240062	181	240185	179
0239507	207	0239644	93	239826	56	240064	111	240197	181
0239513	200	0239645	93	239844	215	240066	176	240199	68
0239514	200	0239646	93	239845	217	240069	54	240200	180
0239515	200	0239647	93	239846	217	240070	54	240201	68
0239516	200	0239648	93	239848	217	240074	55	240205	218
0239517	200	0239649	93	239850	215	240075	2	240206	218
0239518	200	0239650	93	239858	192	240076	2	240210	219
0239519	200	0239651	93	239859	192	240077	3	240211	219
0239520	200	0239652	99	239860	192	240078	2	240231	3
0239521	200	0239653	99	239861	192	240080	53	240232	3
0239522	200	0239654	99	239862	192	240081	52	240240	45
0239523	200	239674	222	239863	192	240086	191	240243	45
0239524	200	239675	222	239866	192	240089	52	240244	45
239530	144	239676	222	239867	192	240090	2	240249	45
239531	137	239682	217	239868	192	240093	2	240250	11
239532	34	239683	217	239878	192	240094	2	240251	11
239533	118	239684	217	239879	192	240098	3	240252	56
239535	102	0239700	19	239880	192	240102	51	240258	2
239536	34	0239701	19	239881	192	240103	52	240259	2
239537	118	0239702	20	239882	192	240106	218	240260	2
239539	102	0239703	20	239883	192	240107	2	240261	2
239541	137	0239708	19	239884	192	240108	2	240262	2
239542	144	0239709	19	239888	193	240112	218	240263	2
239543	34	0239710	19	239889	193	240117	51	240264	2
239544	143	0239711	19	239892	193	240118	51	240265	3
239545	143	239755	180	239893	193	240119	51	240271	3
239546	143	239756	180	239894	193	240120	51	240274	4
239547	143	239760	100	239895	193	240121	52	240274	185
239548	137	239763	86	239899	211	240122	52	240275	4
239550	191	239770	102	239900	211	240123	52	240276	4
0239557	77	239775	137	239942	111	240124	52	240277	1
0239558	77	239776	138	239991	191	240125	52	240284	25
0239559	77	239777	137	0239993	117	240126	52	240285	26
0239561	77	239781	214	239994	191	240127	52	240286	25
0239564	185	239785	46	240000	44	240128	52	240287	25
239567	23	239788	46	240001	44	240129	52	240289	209
239568	8	0239792	161	240004	45	240130	202	240291	44
0239573	102	0239793	161	240005	45	240135	219	240295	219
0239575	102	0239794	162	240013	156	240136	219	240296	219
239578	153	0239795	162	240015	156	240146	202	240299	209
239579	148	0239796	162	240016	156	240147	202	240300	209
239579	153	0239797	162	240017	156	240148	202	240307	209
239580	153	0239798	162	240020	161	240149	202	240308	209
239581	153	0239799	162	240033	154	240150	202	240324	65
0239602	77	0239800	161	240034	154	240151	202	240325	92
0239616	57	0239801	161	240038	191	240152	177	240326	92
0239616	64	0239802	161	240045	54	240153	177	240328	56
0239616	267	0239803	161	240046	54	240154	222	240329	77
0239616	344	0239804	161	240047	54	240155	191	240333	94
0239616	431	0239805	161	240048	54	240158	180	240335	202
239617	184	0239806	161	240049	156	240170	54	240336	202
239617	321	0239807	161	240050	156	240171	54	240337	202
239617	406	0239808	161	240051	156	240172	54	240338	202

NUMERICAL INDEX

Part No.	Page	Part No.	Page	Part No.	Page	Part No.	Page	Part No.	Page
240339	203	240467	191	240590	262	240709	36	241111	380
240348	185	240471	53	240592	261	240735	179	241113	355
240349	41	240475	101	240593	262	240740	179	241113	364
240355	191	240477	193	240594	261	240742	179	241113	384
240356	191	240478	193	240598	35	240743	179	241113	389
240357	185	240479	193	240602	71	240745	179	241114	359
240361	191	240482	193	240604	37	240746	56	241114	390
240362	191	240483	70	240605	37	240747	56	241115	349
240363	191	240485	23	240612	2	240748	56	241115	355
240364	185	240486	8	240613	2	241013	406	241115	361
240371	203	0240487	18	240614	2	241013	463	241115	364
240372	203	0240488	18	240619	70	241014	412	241115	384
240373	203	0240489	18	240620	70	241014	465	241115	389
240374	203	240490	18	240622	3	241038	417	241116	383
240375	203	240491	18	240623	209	241038	467	241117	349
240376	203	240492	18	240624	209	241040	377	241117	361
240379	202	240493	18	240625	186	241040	449	241118	368
240380	202	240494	185	240626	155	241041	375	241119	366
240381	202	240502	176	240629	414	241041	448	241120	399
240382	4	240504	417	240630	55	241044	375	241121	399
240386	68	240504	466	240631	53	241044	448	241123	399
240388	191	240510	153	240633	36	241072	375	241124	344
240389	191	240512	153	240634	36	241072	448	241125	409
240390	289	240517	148	240635	28	241073	375	241126	344
240391	289	240518	41	240535	365	241073	448	241128	344
240391	366	240519	41	240635	368	241074	377	241129	344
240391	444	240520	64	240635	443	241074	449	241130	344
240392	71	240521	68	240635	445	241075	377	241131	344
240393	71	240522	68	240636	36	241076	392	241135	366
240394	71	240523	65	240637	36	241076	457	241136	350
240395	71	240524	63	240638	36	241078	377	241136	435
240396	68	240528	185	240641	65	241078	449	241137	350
240398	68	240529	148	240642	68	241079	377	241137	435
240401	26	240531	148	240652	186	241079	449	241138	350
240403	191	240536	11	240657	27	241080	375	241138	435
240404	191	240538	45	240659	63	241080	448	241139	350
240405	186	240544	18	240662	37	241081	375	241139	435
240420	76	240545	18	240668	28	241081	448	241140	350
240421	77	0240546	18	240669	28	241088	344	241140	435
240422	77	240548	35	240671	35	241089	399	241141	350
240423	77	240550	191	240678	186	241089	460	241141	435
240426	19	240551	35	240679	34	241090	375	241142	350
240427	19	240552	155	240682	34	241091	375	241142	435
240428	144	240556	155	240683	34	241092	375	241143	350
240429	144	240557	69	240688	3	241093	375	241143	435
240446	77	240559	70	240690	86	241096	377	241144	350
240447	77	240560	70	240691	86	241097	377	241144	435
240448	77	240565	262	240692	206	241098	377	241145	350
240449	77	240568	46	240692	207	241099	377	241145	435
240454	185	240569	46	240693	205	241102	376	241146	350
240455	185	240570	44	240693	207	241103	376	241146	435
240457	185	240571	44	240702	217	241104	376	241147	350
240458	185	240582	262	240703	206	241105	376	241147	435
240459	70	240583	1	240703	207	241106	406	241148	361
240462	148	240584	1	240704	206	241106	463	241149	361
240463	191	240585	34	240704	207	241108	390	241150	361
240464	186	240586	34	240707	45	241110	380	241150	441
240466	191	240589	46	240708	3	241111	372	241151	361

NUMERICAL INDEX

Part No.	Page	Part No.	Page	Part No.	Page	Part No.	Page	Part No.	Page
241151	441	241303	375	242043	207	242133	206	0242181	69
241152	361	241304	361	242044	206	242133	207	0242181	71
241152	441	241304	441	242044	207	242134	206	0242182	64
241153	361	241305	361	242051	77	242134	207	0242182	65
241153	441	241305	441	242052	77	242140	27	0242182	69
241154	361	241306	344	242053	84	242141	27	0242182	71
241154	441	241307	409	242054	45	242142	27	242183	214
241155	361	241309	371	242055	45	242143	46	242184	214
241155	441	241309	446	242056	164	242144	27	242188	214
241156	361	241310	368	242057	118	242145	27	242189	214
241156	441	241311	371	242058	34	242146	27	0242191	100
241157	361	241311	446	242059	137	242148	206	0242192	100
241157	441	241371	391	242066	56	242148	207	242199	77
241161	399	241371	456	242067	56	242149	206	242206	195
241162	417	0241419	400	242072	34	242149	207	242207	199
241162	467	0241419	461	242073	34	0242150	63	242225	70
241163	417	0241423	400	242077	5	0242151	64	242225	366
241163	467	0241423	461	242078	2	0242151	65	242225	444
241164	414	0241425	400	242080	65	0242152	64	0242226	137
241164	466	0241425	461	242081	77	0242153	63	0242227	137
241165	414	0241426	400	242082	77	0242154	71	0242229	117
241165	466	0241426	461	242083	77	0242155	71	242230	191
241240	395	241496	456	242084	77	0242156	64	0242231	207
241242	399	242000	46	242093	64	0242157	65	0242232	207
241242	460	242001	46	242094	81	0242158	65	0242233	207
241243	399	242002	46	242095	81	0242159	65	0242234	207
241243	460	242003	45	242096	81	0242160	68	242235	56
241246	366	242004	46	242097	81	0242161	65	0242236	214
241247	366	242005	46	242098	81	0242162	69	0242237	35
241262	406	242006	46	242099	81	0242163	68	0242238	35
241262	463	242007	46	242100	81	0242164	68	0242239	35
241263	406	242008	46	242101	81	0242165	68	0242240	35
241263	463	242014	46	242104	64	0242166	68	242245	205
241272	375	242017	210	242105	68	0242167	69	242245	207
241272	448	242017	211	242106	41	0242167	71	242246	205
241273	375	242018	210	242108	377	0242168	64	242246	207
241273	449	242018	211	242110	81	0242168	65	0242248	71
241274	377	0242019	193	242111	81	0242168	68	242252	71
241274	449	0242020	83	242112	81	0242168	71	242254	39
241282	377	0242021	83	242113	81	0242169	70	0242311	86
241283	350	0242022	83	242114	192	0242170	70	0242312	86
241283	361	0242023	83	242118	2	0242171	71	0242313	261
241283	435	0242025	83	242119	2	0242172	70	0242314	261
241283	441	242026	101	242120	210	0242173	71	0242315	261
241284	350	242033	210	242121	210	0242174	71	0242316	261
241284	435	242033	211	242122	210	0242175	71	0242317	261
241285	361	242037	210	242123	210	0242176	71	0242318	261
241285	441	242037	211	242124	210	0242178	71	0242327	207
241286	362	242038	206	242125	210	0242179	64	0242328	207
241286	441	242038	207	242126	210	0242179	65	0242339	5
241287	362	242039	206	242127	210	0242179	69	0242340	5
241287	441	242039	207	242128	210	0242179	71	0242348	35
241288	362	242040	206	242129	210	0242180	64	0242367	49
241288	441	242040	207	242130	210	0242180	65	0242368	49
241294	377	242041	206	242131	206	0242180	69	0242369	53
241295	377	242041	207	242131	207	0242180	71	0242370	53
241299	344	242042	46	242132	206	0242181	64	242392	192
241302	375	242043	206	242132	207	0242181	65	242393	192

NUMERICAL INDEX

Part No.	Page	Part No.	Page	Part No.	Page	Part No.	Page	Part No.	Page
242394	192	243009	423	0243287	347	243500	405	0243631	405
242395	192	243010	423	0243288	346	243500	462	0243631	462
242398	191	243011	423	0243289	347	243501	405	0243633	400
242415	1	243012	423	0243290	346	243501	462	0243633	461
242416	2	243013	423	0243291	347	243502	383	0243636	400
242417	2	243014	423	0243292	346	243502	451	0243636	461
242419	2	243015	423	0243293	347	243503	383	0243637	400
0242426	5	243016	423	0243294	346	243503	451	0243637	462
242433	45	243020	424	0243295	347	243504	384	0243640	400
242434	64	243021	424	0243296	346	243504	452	0243640	461
242437	63	243021	470	0243297	347	243505	383	0243641	400
242438	65	243050	421	0243298	347	243505	452	0243641	461
242440	68	243051	421	0243299	347	243506	384	0243642	399
242441	70	243052	421	0243300	347	243506	452	0243642	460
242442	70	243052	469	0243301	347	243507	383	0243643	399
242446	4	243053	421	0243302	346	243507	452	0243643	461
0242503	6	243053	469	0243303	347	243508	383	0243644	405
0242504	13	243100	422	0243304	346	243508	452	0243644	463
0242505	13	243101	422	0243305	347	243536	384	0243645	400
0242554	191	243102	422	0243306	347	243536	452	0243645	461
0242555	53	243103	422	0243307	347	243537	384	0243650	399
0242582	35	243109	376	0243308	347	243537	452	0243650	461
0242583	35	243111	391	0243309	347	243538	384	0243651	400
242607	3	243115	399	0243310	347	243538	452	0243651	461
242608	3	243115	460	0243311	347	243584	343	0243652	400
0242643	9	243116	400	0243312	347	243584	431	0243652	461
0242644	9	243116	462	0243313	347	243585	343	0243653	400
242846	25	243136	377	0243314	347	243585	431	0243653	461
242850	25	243136	449	0243315	347	243608	343	0243654	405
242853	25	243137	377	0243316	347	243608	431	0243654	463
242857	25	243137	449	0243317	347	243609	343	0243655	405
0242860	163	243139	391	0243318	347	243609	431	0243655	463
0242861	163	243139	456	0243319	347	243612	391	0243658	405
0242873	64	243140	422	0243320	347	243612	458	0243658	463
0242873	65	243140	469	0243321	347	0243614	400	0243659	406
0242874	64	243141	422	0243322	347	0243614	461	0243659	463
0242875	63	243141	469	0243323	347	0243617	400	243690	447
0242876	71	243142	422	0243324	347	0243618	400	0243695	399
0242877	64	243142	469	0243325	347	0243618	461	0243695	460
0242878	65	243143	422	0243326	347	0243619	400	0243698	400
0242879	65	243143	469	0243327	347	0243619	461	0243698	461
0242880	69	243179	376	0243328	347	0243620	405	0243701	405
0242881	68	243179	449	0243329	347	0243620	463	0243702	405
0242882	68	243180	391	0243330	347	0243621	405	0243704	405
0242882	71	243180	456	0243331	347	0243621	463	0243704	462
0242883	70	243197	376	0243332	346	0243622	405	0243705	405
0242884	71	243198	391	0243333	347	0243622	462	0243705	462
0242885	71	243199	399	243352	342	0243623	405	0243706	405
0242886	71	243199	460	243353	342	0243623	463	0243706	463
0242887	71	243211	400	243354	342	0243624	405	0243707	405
0242888	71	243211	462	243355	342	0243625	405	0243707	463
0242892	163	0243280	347	243364	375	0243625	463	0243708	405
0242893	163	0243281	347	243364	448	0243626	399	0243708	463
0242894	261	0243282	347	243410	424	0243626	460	0243709	405
0242895	261	0243283	347	243410	470	0243627	405	0243709	463
0242896	261	0243284	346	243413	380	0243627	463	0243710	405
0242941	181	0243285	347	243413	451	0243628	400	0243710	406
243008	423	0243286	346	243470	470	0243628	462	0243710	463

NUMERICAL INDEX

Part No.	Page	Part No.	Page	Part No.	Page	Part No.	Page	Part No.	Page
243773	383	0243929	442	244150	456	245186	452	300684	179
243773	452	0243930	365	244151	456	245186	454	300693	25
0243786	400	0243930	442	244160	451	245187	434	300693	26
0243786	461	0243931	277	244175	472	245188	434	300700	25
0243787	400	0243931	352	244176	468	245189	434	300788	101
0243787	461	0243931	436	244177	468	245190	434	300903	176
243801	418	0243932	277	244178	468	245190	440	300917	28
243801	467	0243932	352	244179	468	245191	434	300961	50
243818	361	0243932	436	244181	468	245191	440	300961	55
243880	355	0243933	355	244182	468	245192	434	300978	46
243880	364	0243933	437	245006	457	245193	439	302009	50
243880	384	0243934	355	245007	457	245193	455	302009	55
243880	389	0243934	437	245008	467	245194	437	302046	218
243881	359	243962	64	245009	467	245194	442	302077	10
243881	390	243963	64	245024	464	245194	452	302121	30
243894	359	243964	63	245025	464	245194	454	302121	37
243894	390	243965	431	245052	457	245195	438	302124	27
0243910	276	243970	362	245056	441	245195	455	302134	11
0243910	352	243971	362	245057	441	245196	458	302345	50
0243910	436	243972	362	245058	467	245197	435	302345	55
0243911	277	243973	362	245059	467	245197	440	302413	8
0243911	352	243974	431	245067	451	245200	447	302492	12
0243911	436	243976	431	245070	435	245200	451	302493	48
0243912	355	243977	431	245071	435	245201	464	302493	52
0243912	437	243979	458	245072	441	245202	465	302495	6
0243913	355	243982	431	245073	441	245203	460	302496	6
0243913	437	243983	431	245076	435	245204	444	302501	11
0243914	276	243986	431	245077	435	245204	445	302539	11
0243914	352	243987	431	245078	435	245205	444	302564	204
0243914	436	244001	421	245079	435	245205	445	302578	258
0243915	276	244001	469	245080	431	245206	460	302700	6
0243915	352	244006	342	245084	431	245207	460	302701	11
0243915	436	244006	430	245085	431	245220	440	302701	12
0243916	356	244007	343	245086	431	245221	440	302702	6
0243916	438	244007	430	245087	431	245225	47	302703	11
0243917	356	244008	342	245094	435	245226	47	302714	39
0243917	438	244008	430	245095	435	245230	448	302714	40
0243918	281	244009	342	245096	435	245231	448	302714	41
0243918	356	244009	430	245097	435	245243	465	302723	23
0243918	438	244018	421	245100	441	245262	449	302725	11
0243919	281	244018	469	245101	441	245268	456	302729	10
0243919	356	244019	421	245102	454	245330	458	302738	259
0243919	438	244020	421	245103	454	245348	431	302739	259
0243922	355	244020	469	245104	454	245349	431	302745	50
0243922	437	244092	468	245105	454	245350	431	302745	54
0243923	355	244093	469	245106	454	245351	431	302769	218
0243923	437	244094	468	245107	454	245370	432	302854	35
0243926	285	244097	468	245175	447	300072	181	302867	258
0243926	364	244098	468	245180	451	300136	101	302943	5
0243926	442	244099	468	245181	452	300278	258	302944	5
0243927	285	244100	469	245182	451	300335	8	302952	258
0243927	286	244103	469	245183	452	300413	259	302953	258
0243927	364	244104	469	245184	452	300426	56	302954	258
0243927	442	244131	449	245185	452	300436	40	302955	258
0243928	286	244133	449	245186	435	300593	186	302956	258
0243928	364	244136	449	245186	437	300631	102	302957	258
0243928	442	244137	449	245186	440	300632	102	302958	258
0243929	364	244149	456	245186	442	300644	102	302959	12

NUMERICAL INDEX

Part No.	Page	Part No.	Page	Part No.	Page	Part No.	Page	Part No.	Page
302968	12	0303915	207	306251	470	309859	49	311655	26
302970	12	0303917	207	306536	335	309859	53	311678	83
303004	6	0303918	207	306536	423	309862	39	311705	204
303007	6	303939	4	306536	470	309862	49	0311715	76
303011	6	303939	43	306970	337	309862	53	0311715	83
303014	6	303939	44	306979	426	309863	49	311729	34
303015	6	303939	46	307006	310	309863	53	311797	36
303019	6	303939	47	307006	392	309958	49	311832	214
303021	6	303939	183	307040	202	309958	53	311880	218
303051	8	303939	186	307041	202	309966	23	0311971	163
303052	9	303943	204	307082	44	310065	298	0311972	163
303053	9	303943	206	307088	283	310066	297	0311980	163
303060	9	304001	43	307088	321	310067	297	0311981	163
303061	10	304001	46	307088	325	310084	272	311983	12
303063	9	304001	47	307088	406	310084	283	312372	335
303064	9	304059	217	307088	412	310139	412	312372	424
303065	9	304059	431	307142	271	310139	465	312372	470
303073	259	304060	217	307165	414	310144	412	312373	335
303074	9	304061	217	307165	466	310144	465	312373	424
303075	259	304078	37	307189	375	310145	409	312373	470
303076	259	304078	209	307189	449	310145	464	312374	335
303077	259	304133	75	307458	75	310146	412	312374	424
303078	259	304135	75	307458	82	310146	465	312374	470
303083	259	304193	36	308102	270	310404	295	312435	335
303173	262	304210	153	308102	348	310404	375	312435	423
303289	56	304210	155	308102	433	310404	448	312580	321
303347	56	304218	56	308103	270	310405	295	312586	321
0303435	76	304308	1	308103	348	310405	375	312586	463
0303435	82	304308	37	308103	433	310425	297	312587	321
0303437	76	304308	72	308133	352	310426	297	312587	463
0303437	83	0304315	5	308133	364	310427	297	312596	321
0303439	76	0304316	5	308133	436	310576	271	312636	321
0303439	83	0304317	5	308133	441	310576	349	312636	406
0303442	76	304362	185	308277	2	310576	434	312636	463
0303442	83	304442	259	308352	209	310588	270	312666	321
0303443	76	304479	262	308425	301	310588	348	312666	406
0303443	83	304480	262	308425	380	310588	434	312666	463
303475	219	0304542	207	308425	450	310627	321	312667	321
303515	222	304599	258	308482	301	310638	316	312667	406
0303528	83	0304690	5	308482	380	310638	398	312667	463
303623	262	304698	259	308482	450	310638	460	312709	318
303641	76	0304699	259	308802	298	310639	298	312760	58
303641	83	304704	262	308802	313	310642	298	312760	64
303644	75	304711	5	308802	379	310642	379	312782	58
303645	75	304711	11	308802	395	310642	450	312782	65
303646	75	304711	57	308802	450	310654	297	313561	317
303647	75	304767	191	308802	458	310655	297	313561	400
303660	204	0304813	207	308806	305	311019	275	313561	462
303660	207	304879	9	308806	386	311019	283	313562	318
303661	204	305880	290	308806	454	311085	329	313562	400
303661	207	305880	369	308953	263	311090	329	313562	462
303751	35	305880	445	308953	341	311143	309	313563	317
303807	203	306132	336	308953	429	311143	392	313563	400
303807	207	306132	424	308954	263	311143	457	313563	462
308808	203	306132	470	308954	341	311144	309	313881	335
303808	207	306188	336	308954	429	311144	392	314021	321
303836	9	306188	425	309522	199	311144	457	314021	406
303837	9	306188	471	309834	4	311191	292	314021	464

NUMERICAL INDEX

Part No.	Page	Part No.	Page	Part No.	Page	Part No.	Page	Part No.	Page
314149	65	316985	258	325508	375	327622	344	337149	448
314244	395	316986	258	325509	375	0327796	193	337151	448
314245	395	316987	258	325510	375	327808	193	337273	448
314246	395	316988	258	325511	375	0327872	207	337278	448
314286	414	316989	258	325512	375	0327873	207	337566	440
314286	466	316990	258	325515	377	0327874	207	337638	434
314336	58	317234	333	325515	449	0327875	207	337638	440
314336	65	317234	420	325516	379	0327876	207	337650	448
314429	321	317234	469	325516	450	0327877	207	337743	458
314440	264	317235	333	325517	379	0327879	207	337746	458
314440	430	317235	420	325683	366	0327894	35	0337956	432
314441	264	317235	469	325724	44	0327895	35	0337957	432
314441	342	317512	203	325766	375	0327896	35	0337958	432
314468	298	317512	207	325767	375	0327897	35	0337959	432
314469	298	317513	203	325789	346	0327898	35	0337960	432
314537	412	317513	207	325789	432	0327899	35	0337961	432
314537	464	317520	203	325790	346	328074	427	0337962	432
314737	337	317520	204	325790	432	328074	472	0337963	432
314737	425	317520	207	325873	361	0328570	399	0337964	432
314737	471	317521	203	325919	405	0328570	460	0337965	432
314759	375	317521	204	325919	462	328571	430	0337966	432
314759	449	317521	207	325931	414	0328865	356	0337967	432
0314920	321	317615	203	325931	466	0328865	438	0337968	432
0314920	406	317615	207	325936	399	0328866	356	0337969	432
0314920	464	317616	203	325936	460	0328866	438	0337970	433
0314921	321	317616	207	325936	460	0328867	278	0337971	433
0314921	406	317805	28	326030	349	0328868	278	0337972	433
0314921	464	0317859	207	326030	361	330566	77	0337973	433
0314922	321	0317946	207	326046	406	331519	355	0337974	433
0314922	406	0317947	207	326046	414	331591	359	0337975	433
0314922	464	0317948	207	326046	464	331591	365	0337976	433
0314923	321	318526	379	326046	465	331591	384	0337977	433
0314923	406	318526	450	326058	377	331591	389	0337978	433
0314923	464	318533	379	326058	449	331591	395	0337979	433
314936	350	318533	449	326246	341	331591	437	0337980	432
314936	362	318535	377	326568	192	331591	439	0337981	432
314936	441	318535	449	326569	192	331591	452	338242	148
314936	435	318999	412	326570	192	331591	454	338580	26
315829	11	318999	465	326577	192	331591	455	338691	27
315988	5	0320426	102	326579	193	331591	458	338735	27
316167	27	320534	217	326582	193	331591	458	338811	260
316188	10	320547	56	326585	192	331638	449	338935	142
316208	2	0320707	301	326765	258	334068	471	339141	472
316209	2	0320707	380	326815	34	0335467	142	0341072	215
316210	2	0320707	450	0326897	77	335494	182	0341072	217
316211	2	320851	2	326953	214	335871	2	0341073	215
316226	155	320980	36	327258	379	337017	434	0341073	217
316260	218	324226	193	327258	450	337017	440	0341074	215
316398	262	324418	182	327320	344	337017	464	0341074	217
316556	37	324442	77	327342	349	337017	465	0341075	215
316556	65	324444	80	327342	361	337057	465	0341075	217
316556	68	324486	206	327463	361	337068	444	0341076	215
316556	70	324621	34	327565	83	337069	444	0341077	215
316861	6	324755	35	327565	368	337111	445	0341078	215
316934	204	324902	191	327566	366	337112	444	0341079	215
316934	206	324905	3	327567	83	337113	444	0341080	215
316978	258	325089	424	327569	68	337114	444	0341081	215
316980	258	325446	427	327569	77	337115	444	0341082	215
316981	258	325447	425	327570	65	337146	448	0341088	217
316982	258	325447	471	327572	35	337147	448	0341089	217
316983	258	325448	425	327587	76	337148	448	0341090	217
316984	258	325448	471	327622	64				

Item No.	Description	Quantity	Unit Price	Total Price
1
2
3
4
5
6
7
8
9
10
11
12
13
14
15
16
17
18
19
20
21
22
23
24
25
26
27
28
29
30
31
32
33
34
35
36
37
38
39
40
41
42
43
44
45
46
47
48
49
50
51
52
53
54
55
56
57
58
59
60
61
62
63
64
65
66
67
68
69
70
71
72
73
74
75
76
77
78
79
80
81
82
83
84
85
86
87
88
89
90
91
92
93
94
95
96
97
98
99
100



STOCKROOM MEMORANDA

Models 1500-1-2-6-7-8, 1603-4-5-7-8, 1707-8

FRONT SPRING IDENTIFICATION

PIECE NO.

232561	1750 lbs.	90 lb. rate	White - Yellow
237559	1925	105	White - Orange
232480	1850	95	White - Red
237425	2025	105	White - Green
237905	2125	120	White - Blue
237686	2325	120	Red - Yellow
237906	2225	120	White - Yellow
237907	2450	120	Red - Silver
237851	1750	130	White - Light Blue
237852	1925	130	White - Grey
237853	1850	130	White - Brown
237854	2025	130	White - Pink
237855	2125	145	Light Blue
237856	2325	150	Grey
237857	2225	145	Brown
237858	2450	155	Pink
239106	2450	130	White - Dark Blue
240293	2550	125	Green - White
242374	2550	150	Red - Blue

STANDARD AXLE RATIO

1500-1-2, 1603-4-5	Standard 4.69 - 1	61-13 teeth
1500-1-2, 1603-4-5	Special 4.36 - 1	61-14 teeth
1500-1-2, 1603-4-5	Special 4.09 - 1	59-12 teeth
1506-7-8, 1607-8, 1707-8	Standard 4.41 - 1	75-17 teeth
1506-7-8, 1607-8, 1707-8	Special 4.69 - 1	75-16 teeth
1506-7-8, 1607-8, 1707-8	Special 4.06 - 1	69-17 teeth

SPEEDOMETER RATIOS

Models 1500-1-2, 1603-4-5

4.69 - 1 axle	18 tooth pinion No. 237128	6 tooth gear No. 234604
4.36 - 1 axle	17 tooth pinion No. 316278	6 tooth gear No. 234605
4.9 - 1 axle	16 tooth pinion No. 237667	5 tooth gear No. 237655

Models 1506-7-8, 1607-8, 1707-8

4.41 - 1 axle	22 tooth pinion No. 237886	8 tooth gear No. 237885
4.69 - 1 axle	18 tooth pinion No. 237128	6 tooth gear No. 234604
4.06 - 1 axle	26 tooth pinion No. 237129	10 tooth gear No. 234603

CONNECTING ROD BEARINGS
Models 1500-1-2, 1603-4-5

	COPPER LEAD	BABBITT
Motor connecting rod bearing assembly - Standard	225192 237333
.001 under	225193 None
.002 under	225194 231074
.003 under	225195 None
.005 under	None 231075
.015 under	225196 231076

CONNECTING ROD BEARINGS
Models 1506-7-8, 1607-8, 1707-8

		1506-7-8		1607-8, 1707-8			
		COPPER LEAD		BABBITT		COPPER LEAD	
		RIGHT	LEFT	RIGHT	LEFT	RIGHT	LEFT
		BANK	BANK	BANK	BANK	BANK	BANK
Motor Connecting Rod Bearing Assembly	Standard	225202	225207	237335	237336	239642	239643
	.001 under	225203	225208	None	None	239644	239645
	.002 under	225204	225209	231080	231083	239646	239647
	.003 under	225205	225210	None	None	239648	239649
	.005 under	None	None	231081	231084	None	None
	.015 under	225206	225211	231082	231085	239650	239651

PISTON IDENTIFICATIONS

Standard	White
.003 oversize	Brown
.005 oversize	Lemon
.010 oversize	Dark Blue
.015 oversize	Green
.020 oversize	Dark Red
.025 oversize	Grey
.030 oversize	Black
.035 oversize	Orange
.045 oversize	Light Green

Piston rings are marked the same as pistons.

All pistons are deep grooved and require "C" Wall Perfect Circle X-90 rings.

The piston ring set-up is:

- 1500-1-2, 1603-4-5 - Top Groove - Plain Compression
- 2nd Groove - No. 70 Perfect Circle Compression
- 3rd Groove - No. 85 Perfect Circle Oil Ring
- 4th Groove - No. X-90-85 Perfect Circle Oil Ring

PISTON IDENTIFICATIONS (Cont'd.)

1506-7-8, 1607-8, 1707-8 - Top Groove - Plain Compression
 2nd Groove - No. 70 Perfect Circle
 3rd Groove - No. 70 Perfect Circle
 4th Groove - No. X-90-85 Perfect Circle Oil Ring

Width of ring grooves:

1500-1-2, 1603-4-5		1506-7-8, 1607-8, 1707-8	
No. 1 - 1/8	No. 1 - 1/8	
No. 2 - 1/8	No. 2 - 1/8	
No. 3 - 5/32	No. 3 - 1/8	
No. 4 - 5/32	No. 4 - 5/32	

PISTON PIN IDENTIFICATIONS

1500-1-2, 1603-4-5		1506-7-8, 1607-8, 1707-8		
Standard	158042	202838	White	
.003 oversize	163879	202814	Dark Red	
.006 oversize	163880	202815	Dark Blue	

Manufacturing variations in piston sizes are now marked on the top of piston as follows:

16TH AND 17TH SERIES
 PISTON DIAMETER MARKING CHART

3 3/16

MARK	STD.	.003	.005	.010	.015	.020	.025	.030	.035	.045
A-A	3.18625	3.18925	3.19125	3.19625	3.20125	3.20625	3.21125	3.21625	3.22125	3.23125
	3.18650	3.18950	3.19150	3.19650	3.20150	3.20650	3.21150	3.21650	3.22150	3.23150
A	3.18650	3.18950	3.19150	3.19650	3.20150	3.20650	3.21150	3.21650	3.22150	3.23150
	3.18675	3.18975	3.19175	3.19675	3.20175	3.20675	3.21175	3.21675	3.22175	3.23175
B-B	3.18675	3.18975	3.19175	3.19675	3.20175	3.20675	3.21175	3.21675	3.22175	2.23175
	3.18700	3.19000	3.19200	3.19700	3.20200	3.20700	3.21200	3.21700	3.22200	3.23200
B	3.18700	3.19000	3.19200	3.19700	3.20200	3.20700	3.21200	3.21700	3.22200	3.23200
	3.18725	3.19025	3.19225	3.19725	3.20225	3.20725	3.21225	3.21725	3.22225	3.23225
C-C	3.18725	3.19025	3.19225	3.19725	3.20225	3.20725	3.21225	3.21725	3.22225	3.23225
	3.18750	3.19050	3.19250	3.19750	3.20250	3.20750	3.21250	3.21750	3.22250	3.23250
C	3.18750	3.19050	3.19250	3.19750	3.20250	3.20750	3.21250	3.21750	3.22250	3.23250
	3.18775	3.19075	3.19275	3.19775	3.20275	3.20775	3.21275	3.21775	3.22275	3.23275
D-D	3.18775	3.19075	3.19275	3.19775	3.20275	3.20775	3.21275	3.21775	3.22275	3.23275
	3.18800	3.19100	3.19300	3.19800	3.20300	3.20800	3.21300	3.21800	3.22300	3.23300
D	3.18800	3.19100	3.19300	3.19800	3.20300	3.20800	3.21300	3.21800	3.22300	3.23300
	3.18825	3.19125	3.19325	3.19825	3.20325	3.20825	3.21325	3.21825	3.22325	3.23325

PISTON DIAMETER MARKING CHART (Cont'd.)

3-7/16

MARK	STD.	.003	.005	.010	.015	.020	.030	.040	.045
A-A	3.43625 3.43650	3.43925 3.43950	3.44125 3.44150	3.44625 3.44650	3.45125 3.45150	3.45625 3.45650	3.46625 3.46650	3.47625 3.47650	3.48125 3.48150
A	3.43650 3.43675	3.43950 3.43975	3.44150 3.44175	3.44650 3.44675	3.45150 3.45175	3.45650 3.45675	3.46650 3.46675	3.47650 3.47675	3.48150 3.48175
B-B	3.43675 3.43700	3.43975 3.44000	3.44175 3.44200	3.44675 3.44700	3.45175 3.45200	3.45675 3.45700	3.46675 3.46700	3.47675 3.47700	3.48175 3.48200
B	3.43700 3.43725	3.44000 3.44025	3.44200 3.44225	3.44700 3.44725	3.45200 3.45225	3.45700 3.45725	3.46700 3.46725	3.47700 3.47725	3.48200 3.48225
C-C	3.43725 3.43750	3.44025 3.44050	3.44225 3.44250	3.44725 3.44750	3.45225 3.45250	3.45725 3.45750	3.46725 3.46750	3.47725 3.47750	3.48225 3.48250
C	3.43750 3.43775	3.44050 3.44075	3.44250 3.44275	3.44750 3.44775	3.45250 3.45275	3.45750 3.45775	3.46750 3.46775	3.47750 3.47775	3.48250 3.48275
D-D	3.43775 3.43800	3.44075 3.44100	3.44275 3.44300	3.44775 3.44800	3.45275 3.45300	3.45775 3.45800	3.46775 3.46800	3.47775 3.47800	3.48275 3.48300
D	3.43800 3.43825	3.44100 3.44125	3.44300 3.44325	3.44800 3.44825	3.45300 3.45325	3.45800 3.45825	3.46800 3.47825	3.47800 3.47825	3.48300 3.48325

CYLINDER BORE SIZE STAMPED WITH
AN INK STAMP 1/2 INCH HIGH

Model 1603-4-5 - Top face left side of No. 1 cylinder
1607-8, 1707-8 - Top face left side of No. 1 without right bank

Piston size stamped on top of pistons.

TIRE SIZES AND PRESSURES

MODEL	SIZE	FRONT	REAR
1500 16 x 7.50 - 6 ply 26 lbs. 28 lbs.
1501 16 x 7.50 - 6 ply 26 lbs. 30 lbs.
1502 16 x 7.50 - 6 ply 26 lbs. 32 lbs.
1506-7-8 16 x 8.25 - 6 ply 28 lbs. 32 lbs.
1603 16 x 7.50 - 6 ply 24 lbs. 27 lbs.
1604 16 x 7.50 - 6 ply 24 lbs. 27 lbs.
1605 16 x 7.50 - 6 ply 24 lbs. 29 lbs.
1607-1707 16 x 8.25 - 6 ply 26 lbs. 27 lbs.
1608-1708 16 x 8.25 - 6 ply 26 lbs. 29 lbs.

ELECTRIC WIRING FUSE

302121 - SFE - 1/4 x 1-1/4 - 20 Amp.

REAR SPRING ASSEMBLIES - 58" x 2"
Models 1500-1-2

PIECE NO.		LOAD		RATE
237641	Rear spring and covers assembled	1300	x	145
237640	Rear spring and covers assembled	1400	x	165
237926	Rear spring and covers assembled	1400	x	165
237643	Rear spring and covers assembled	1500	x	145
239367	Rear spring and covers assembled	1500	x	155
237925	Rear spring and covers assembled	1500	x	165
237927	Rear spring and covers assembled	1600	x	165
237653	Rear spring and covers assembled	1700	x	165

REAR SPRING ASSEMBLIES - 58" x 2"
Models 1603-4-5

242033	Rear spring and covers assembled	1400	x	135
242017	Rear spring and covers assembled	1300	x	120
242037	Rear spring and covers assembled	1500	x	135
237653	Rear spring and covers assembled	1700	x	165

REAR SPRING ASSEMBLIES - 60-1/2" x 2-1/4"
Models 1506-7-8, 1607-8, 1707-8

237644	Rear spring and covers assembly	1300	x	150
237642	Rear spring and covers assembly	1400	x	150
237930	Rear spring and covers assembly	1400	x	165
237645	Rear spring and covers assembly	1500	x	150
237929	Rear spring and covers assembly	1500	x	165
239472	Rear spring and covers assembly	1500	x	175
239147	Rear spring and covers assembly	1600	x	185
242018	Rear spring and covers assembly	1300	x	120

CLUTCH

Models 1500-1-2, 1603-4-5

221947	Clutch driven plate facing (Raybestos No. 250)	Size 7 x 12 x .140
--------	--	--------------------

CLUTCH

Models 1506-7-8, 1607-8, 1707-8

213372	Clutch driven plate facing (Hyco No. 3903-PDX)	Size 7 x 12 x .137
228617	Clutch driven plate facing rivets	(48 required)

GASOLINE SYSTEM

232165	Carburetor - Stromberg No. EE-23	Models 1500-1-2, 1603-4-5
232166	Carburetor - Stromberg No. EE-3	Models 1506-7-8, 1607-8, 1707-8
232134	Motor fuel pump - AC	Models 1500-1-2, 1603-4-5
221006	Motor fuel pump - AC	Models 1506-7-8, 1607-8, 1707-8
237563	Motor carburetor air cleaner and silencer AC Oil bath	Models 1500-1-2
205611	Motor carburetor air cleaner and silencer AC	Models 1506-7-8
240690	Motor carburetor air cleaner and silencer AC Oil bath	Models 1603-4-5
239763	Motor carburetor air cleaner and silencer AC	Models 1607-8, 1707-8

FRONT SUSPENSION

	1500-1-2, 1603-4-5	1506-7-8, 1607-8, 1707-8
Caster	2-1/2°	0°
Camber	1°	1°
Toe-in	1/32-1/8	1/32-1/8
Tread	59-1/4"	60-1/4"

Shims for Adjusting Caster

1500-1-2, 1603-4-5 -	Piece No. 304698 - 1°
	304699 - 1/2°
1506-7-8, 1607-8, 1707-8 -	Piece No. 239342 - 1°
	239343 - 1/2°

Camber adjustment:

OFFSET PILOTS

MODELS 1500-1-2, 1603-4-5

Piece No. 303075 - No offset
303076 - 1/16 offset
303077 - 1/8 offset
303078 - 3/16 offset

UPPER SUPPORT BUSHING
CLEVIS SPACER

MODELS 1506-7-8, 1607-8, 1707-8

Piece No. 237065 - 1/8 thick
237066 - 3/16 thick
237067 - 1/4 thick
237753 - 5/16 thick

SHOCK ABSORBER VALVES

Models 1500-1-2

317946 - 3F	303918 - 2C
317859 - 2B	304542 - 1F
303915 - 2F	317947 - 5F
317948 - GO	304813 - E2
.....	303917 - 2D

Models 1506-7-8

239080 - 3C	239029 - C-3-W
239027 - 4C	239028 - A-3-W
239030 - 1N	231028 - E1
239498 - 2N	225673 - E3
239494 - A3	239497 - C2
239507 - 1J	239495 - C3

SHOCK ABSORBER VALVES (Cont'd.)
Models 1603-4-5

327872 - 2-E-1	327876 - 4-D-1
327873 - 3-C-3	327875 - 3-D-1
327874 - 3-E-5	242328 - 6-D-1
242327 - 2-C-5	230399 - 5-J
327875 - 3-D-1	327879 - 5-P-4
.....	327877 - E-O-2
.....	242232 - E-1-W

Models 1607-8

242234 - 3-E	242231 - C-1-W
239495 - C-3	242233 - C-4
239507 - I-J	242232 - E-1-W

MOTOR LUBRICATION SCHEDULE

Below minus - 10 deg. F - S.A.E. 10-W plus 10% kerosene
 Minus - 10 deg. F - S.A.E. 10-W
 Plus - 10 deg. F - S.A.E. 20-W
 Plus - 32 deg. F or over - S.A.E. 30
 Plus - 90 deg. F or over - S.A.E. 40
 Average daylight temperature

WATER PUMP PACKING

231175 - 1500-1-2, 1603-4-5 - Water pump packing - Install in addition to old packing.
 Not necessary to remove old packing from pump.

MOTOR CYLINDER HEADS

237996 - Aluminum	6.50 to 1 ratio - 1500-1-2, 1603-4-5
239014 - Aluminum	7.00 to 1 ratio - 1500-1-2, 1603-4-5
237698 - Aluminum - right	6.4 to 1 ratio - 1506-7-8, 1607-8, 1707-8
237695 - Aluminum - right	6.00 to 1 ratio - 1506-7-8, 1607-8, 1707-8
237697 - Aluminum - right	7.00 to 1 ratio - 1506-7-8, 1607-8, 1707-8
276999 - Aluminum - left	6.4 to 1 ratio - 1506-7-8, 1607-8, 1707-8
237695 - Aluminum - left	6.00 to 1 ratio - 1506-7-8, 1607-8, 1707-8
237697 - Aluminum - left	7.00 to 1 ratio - 1506-7-8, 1607-8, 1707-8

BRAKE CYLINDERS

1500-1-2, 1603-4-5	Front wheel - 1-1/4" diameter - 237023-L 237024-R
1506-7-8, 1607-8	Rear wheel - 1-1/8" diameter - 237025-L 237026-R
1500-1-2, 1603-4-5	Master cylinder - Piece No. 234790
1506-7-8, 1607-8, 1707-8	Master cylinder - Piece No. 237618

SERVICE BRAKE LINING

1500-1-2, 1603-4-5 Primary - Piece No. 242643 - Marshall 2201
 Secondary - Piece No. 242643 - Marshall 2201
 1506-7-8, 1607-8, 1707-8 Primary - Piece No. 242890 - Marshall 2201
 Secondary - Piece No. 242890 - Marshall 2201

BRAKE FLUID

304690 - Pint can
 304315 - Quart can
 304316 - 1 Gallon can
 304317 - 5 Gallon can

LAMP BULBS

Head - right 32-32 C.P. - Mazda No. 2330-L
 Head - left 32-21 C.P. - Mazda No. 1104
 Parking 1-1/2 C.P. - Mazda No. 55
 Instrument board 3 C.P. - Mazda No. B-63
 Stop 15 C.P. - Mazda No. 87
 Tail 3 C.P. - Mazda No. B-63
 Dome 6 C.P. - Mazda No. 81
 Fender 1-1/2 C.P. - Mazda No. 55
 Instrument board signal08 C.P. - Mazda No. 51
 Instrument board reading light 3 C.P. - Mazda No. B-63
 Radio control08 C.P. - Mazda No. 51

CAPACITIES

	1500-1-2	1603-4-5	1506-7-8, 1607-8, 1707-8
Cooling system	24 Qt.	20 Qt.	40 Qt.
Crankcase	8 Qt.	8 Qt.	10 Qt.
Gas Tank	25 Gal.	24 Gal.	30 Gal.
Rear Axle	6.5 Pt.	6.5 Pt.	6 Pt.
Transmission	4.5 Pt.	4.5 Pt.	4.5 Pt.

SPARK PLUGS

239454 - 10 M.M. - AC - Use 237879 Spark Plug Wrench
 338935 - 10 M.M. - Champion - Use 237879 Spark Plug Wrench

ELECTRICAL EQUIPMENT

Generator Model 1500-1-2 - Delco Remy 961-J or Auto Lite GCO-4803-A
 Model 1506-7-8 - Delco Remy 930-F or Auto Lite GCE-4803-A
 Starter Motor Model 1500-1-2 - Delco Remy 729-H or Auto Lite MAX-4014
 Model 1506-7-8 - Delco Remy 664 or Auto Lite NC-1389

ELECTRICAL EQUIPMENT (Cont'd.)

Distributor	Model 1500-1-2 - Delco Remy 663-L or Auto Lite IGT-4005	
	Model 1506-7-8 -	Auto Lite IGO-4002-A
Regulator	Model 1500-1-2 - Delco Remy 5813 or Auto Lite VRB-4002-D	
	Model 1506-7-8 - Delco Remy 5811 or Auto Lite VRB-4008-A	
Ignition Coil	Model 1500-1-2 - Delco Remy 539-K or Auto Lite CE-4026	
	Model 1506-7-8 -	Auto Lite CE-4022
Generator	Model 1603-4-5	Auto Lite GCO-4803-A
	Model 1607-8, 1707-8	Auto Lite GCE-4803-A
Starter Motor	Model 1603-4-5	Auto Lite MAX-4014
	Model 1607-8, 1707-8	Auto Lite DN-1389
Distributor	Model 1603-4-5	Auto Lite IGT-4006
	Model 1607-8, 1707-8	Auto Lite IGO-4002-A
Regulator	Model 1603-4-5	Auto Lite VRB-4002-D
	Model 1607-8, 1707-8	Auto Lite VRB-4008-AP
Ignition Coil	Model 1603-4-5	Auto Lite CE-4026
	Model 1607-8, 1707-8	Auto Lite CE-1203

RADIATOR HOSE

	1500-1-2, 1603-4-5	1506-7-8, 1607-8	1707-8
Upper Hose	6-1/2 x 1-3/4 I.D.	13 x 1-1/2 I.D.	11-7/16 x 1-1/2
		14 x 1-1/2 I.D.	12-9/16 x 1-1/2
Lower Hose	5-5/8 x 1-3/4 I.D.	11 x 2 I.D.	7-3/4 x 2 I.D.

WINDSHIELD WIPER BLADE

Piece No. 220860 - 8-3/4" long - 1500-1-2, 1506-7-8 for Bodies

- 1012-1003 1032-1033
- 1013-1014 1023-1034
- 1015-1016 1035-1036
- 1017-1018 1037-1038

Piece No. 227780 - 8-1/2" long - 1501-2 - 1507-8 for Bodies

- 1019-1063 1039-1073
- 1007 1027

Piece No. 211059 - 9" long - All 16th and 17th Series Models

BEARINGS

201652 R.A. differential pinion bearing		
front	1500-1-2, 1603-4-5	Double row ball
196726 R.A. differential pinion bearing		
front	1506-7-8, 1607-8, 1707-8	Double row ball
197122 R.A. differential pinion bearing		
rear	1500-1-2, 1603-4-5	Double row ball
141358 R.A. differential pinion bearing		
rear	1506-7-8, 1607-8, 1707-8	Double row ball

BEARINGS (Cont'd.)

202843	R.A. differential bearing assembly .	1500-1-2, 1603-4-5	Taper roller
187050	R.A. differential bearing assembly .	1506-7-8, 1607-8, 1707-8	Taper roller
176592	Shaft bearing assembly	1500-1-2, 1603-4-5	Taper roller
205684	Shaft bearing assembly	1506-7-8, 1607-8, 1707-8	Taper roller
176593	Steering knuckle bearing assembly- inboard	1500-1-2, 1603-4-5	Taper roller
136769	Steering knuckle bearing assembly- inboard	1506-7-8, 1607-8, 1707-8	Taper roller
97056	Steering knuckle bearing assembly outboard	1500-1-2-6-7-8 1603-4-5-7-8, 1707-8	Taper roller
300278	Steering knuckle thrust bearing	1500-1-2	Single row ball thrust
237081	Steering knuckle thrust bearing	1506-7-8	Single row ball thrust
240032	Steering knuckle thrust bearing	1603-4-5	Single row ball thrust
237081	Steering knuckle thrust bearing	1607-8, 1707-8	Single row ball thrust
239039	Wheel front support arm outer bear- ing front assembly	1506-7-8, 1607-8, 1707-8	Roller
300278	Wheel front support arm outer bear- ing (thrust)	1500-1-2, 1603-4-5	Single row ball thrust
232759	Wheel front support arm outer bear- ing (thrust)	1506-7-8, 1607-8, 1707-8	Single row ball thrust
302046	Steering crank bearing	1500-1-2, 1603-4-5	Single row ball thrust
232494	Steering crank bearing	1506-7-8, 1607-8	Taper roller
232980	Steering gear shaft bearing assembly	1500-1-2-6-7-8 1603-4-5-7-8, 1707-8	Single row ball
234507	Steering worm bearing cage and rollers	1500-1-2-6-7-8 1603-4-5-7-8, 1707-8	Taper roller
234509	Steering worm bearing cup	1500-1-2-6-7-8 1603-4-5-7-8, 1707-8	Taper roller
237227	Steering gear cross shaft bearing-- inner	1500-1-2-6-7-8 1603-4-5-7-8	Roller
237814	Steering gear cross shaft bearing-- outer	1500-1-2-6-7-8 1603-4-5-7-8	Roller
232276	Clutch pedal bearing	1500-1-2, 1603-4-5	Roller
237194	Clutch pedal bearing	1506-7-8, 1607-8, 1707-8	Roller
205454	Clutch shaft front bearing	1500-1-2-6-7-8 1603-4-5-7-8, 1707-8	Single row ball
196611	Clutch shaft rear bearing	1500-1-2-6-7-8 1603-4-5-7-8	Single row ball
230328	Clutch shifter thrust bearing	1500-1-2-6-7-8 1603-4-5-7-8, 1707-8	Single row ball thrust
201328	Transmission countershaft bearing-- front	1500-1-2-6-7-8 1603-4-5-7-8, 1707-8	Double row ball
201381	Transmission countershaft bearing-- rear	1500-1-2-6-7-8 1603-4-5-7-8, 1707-8	Roller
201389	Transmission driving shaft bearing-- front	1500-1-2-6-7-8 1603-4-5-7-8, 1707-8	Roller
196614	Transmission driving shaft bearing-- rear	1500-12-6-7-8 1603-4-5-7-8, 1707-8	Single row ball

BEARINGS (Cont'd.)

196593	Transmission first speed gear bearing	1500-1-2-6-7-8 1603-4-5-7-8, 1707-8	Single row ball
196593	Transmission second speed gear bearing	1500-1-2-6-7-8 1603-4-5-7-8	Single row ball

If you need a body wiring diagram, order:

Misc. 4 - 8335 - For body 1103	Misc. 4 - 8341 - For body 1115
4 - 8336 - For body 1113	4 - 8342 - For body 1135-1235
4 - 8337 - For body 1123	4 - 8343 - For body 1116
4 - 8338 - For body 1133-1233	4 - 8344 - For body 1136-1236
4 - 8339 - For body 1114	4 - 8345 - For body 1117
4 - 8340 - For body 1134-1234	4 - 8346 - For body 1137-1237

Misc. 4 - 8347 - For body 1118
4 - 8348 - For body 1138-1238
4 - 8349 - For body 1119-1139-1239
4 - 8350 - For body 1112
4 - 8351 - For body 1132-1232
4 - 8354 - For body 1107-1127-1227
4 - 8355 - For body 1143-1153-1253

THE UNIVERSITY OF CHICAGO

1954

THE UNIVERSITY OF CHICAGO
DEPARTMENT OF CHEMISTRY
58 CHEMISTRY BUILDING
CHICAGO, ILLINOIS 60637

TO: THE UNIVERSITY OF CHICAGO
FROM: THE UNIVERSITY OF CHICAGO
SUBJECT: THE UNIVERSITY OF CHICAGO

THE UNIVERSITY OF CHICAGO
DEPARTMENT OF CHEMISTRY
58 CHEMISTRY BUILDING
CHICAGO, ILLINOIS 60637

SERVICE PARTS LIST--PACKARD SUPER-EIGHT AND TWELVE

Bonnet I

Piece No.	Name	1500	1506	1603	1607	1707	
		1501	1507	1604	1608	1708	
		1502	1508	1605	No. Required		
BONNET							
(Specify color and striping on all orders for bonnet assemblies)							
234943	Bonnet assembly (Specify color)	1	-	-	-	-	
240583	Bonnet assembly (Specify color)	-	-	1	-	-	
230207	Bonnet assembly (Specify color)	-	1	-	-	-	
240584	Bonnet assembly (Specify color)	-	-	-	1	-	
242415	Bonnet assembly (Specify color)	-	-	-	-	1	
225015	Bonnet clamp bracket front assembly - right ...	1	-	-	-	-	
225013	Bonnet clamp bracket front assembly - right ...	-	1	-	-	-	
225016	Bonnet clamp bracket front assembly - left	1	-	-	-	-	
225014	Bonnet clamp bracket front assembly - left	-	1	-	-	-	
223329	Bonnet clamp bracket rear right	1	1	-	-	-	
228849	Bonnet clamp bracket rear left	1	1	-	-	-	
5430	Bonnet clamp bracket to radiator core screw ...	4	4	-	-	-	
5502	Lockwasher 1/4	4	4	-	-	-	
7824	Bonnet clamp bracket to radiator core bolt 1/4-28 x 5/8 hex. hd.	-	2	-	-	-	
5502	Lockwasher 1/4	-	2	-	-	-	
7004	Nut 1/4-28	-	2	-	-	-	
7842	Bonnet clamp bracket front to radiator fan shroud screw 1/4-28 x 1-1/4 hex. hd.	-	2	-	-	-	
62065	Washer 1/4 special (plain)	-	2	-	-	-	
5502	Lockwasher 1/4	-	2	-	-	-	
7004	Nut 1/4-28	-	2	-	-	-	
223481	Bonnet clamp handle - left	1	1	-	-	-	
223480	Bonnet clamp handle - right	1	1	-	-	-	
194601	Bonnet clamp handle nut	2	2	-	-	-	
6597	Bonnet clamp handle lockwasher 3/8 (Shakeproof)	2	2	-	-	-	
223443	Bonnet clamp operating lever - right	1	1	-	-	-	
223444	Bonnet clamp operating lever - left	1	1	-	-	-	
223437	Bonnet clamp operating lever bearing plate assembly - right	1	1	-	-	-	
223438	Bonnet clamp operating lever bearing plate assembly - left	1	1	-	-	-	
223434	Bonnet clamp rod - right	1	-	-	-	-	
223432	Bonnet clamp rod - right	-	1	-	-	-	
223435	Bonnet clamp rod - left	1	-	-	-	-	
223433	Bonnet clamp rod - left	-	1	-	-	-	
210297	Bonnet clamp rod bearing	4	4	-	-	-	
182215	Bonnet clamp rod bearing screw	8	8	-	-	-	
5500	Lockwasher No. 10	8	8	-	-	-	
7003	Nut No. 10-32	8	8	-	-	-	
240277	Bonnet cowl bumper	-	-	2	2	2	
304308	Bonnet cowl bumper screw No. 10 (Parker Kalon binding head)	-	-	4	4	4	
225694	Bonnet cowl guard	2	2	-	-	-	
199787	Screw No. 8 x 1/2 (Parker Kalon)	10	10	-	-	-	
223104	Bonnet hinge side pin	2	-	-	-	-	
223103	Bonnet hinge side pin	-	2	-	-	-	

Piece No.	Name	1500	1506	1603	1607	1707
		1501	1507	1604	1608	1708
		1502	1508	1605	No. Required	
240258	Bonnet hinge side pin	-	-	2	2	2
194732	Bonnet hinge side pin spring washer	x	x	x	x	x
240107	Bonnet lock assembly - left	-	-	1	1	1
240108	Bonnet lock assembly - right	-	-	1	1	1
182215	Bonnet lock bracket screw	-	-	8	8	8
7003	Nut No. 10-32	-	-	8	8	8
5500	Lockwasher No. 10	-	-	8	8	8
320851	Bonnet lock handle	-	-	2	2	-
335871	Bonnet lock handle	-	-	-	-	2
194601	Bonnet lock handle nut	-	-	2	2	2
6597	Bonnet lock handle nut lockwasher 3/8 (Shakeproof)	-	-	2	2	2
240259	Bonnet lock striker - front left	-	-	1	1	1
240260	Bonnet lock striker - front right	-	-	1	1	1
240261	Bonnet lock striker - rear left	-	-	1	1	1
240262	Bonnet lock striker - rear right	-	-	1	1	1
240093	Bonnet louver door assembly - left	-	-	-	3	3
240094	Bonnet louver door assembly - right	-	-	-	3	3
240613	Bonnet louver door moulding - right	-	-	-	3	3
240612	Bonnet louver door moulding - left	-	-	-	3	3
240614	Bonnet louver door moulding retainer	-	-	-	6	6
242078	Bonnet louver door rear spring anchor	-	-	-	2	2
308277	Bonnet louver door rear stop screw No. 6 x 1/4 (Parker Kalon binding head)	-	-	-	2	2
242118	Bonnet louver door spring - long	-	-	-	6	6
242119	Bonnet louver door spring - short	-	-	-	2	2
234650	Bonnet louver panel - front right	1	-	-	-	-
316210	Bonnet louver panel - front right	-	-	1	1	-
242417	Bonnet louver panel - front right	-	-	-	-	1
234649	Bonnet louver panel - front left	1	-	-	-	-
316211	Bonnet louver panel - front left	-	-	1	1	-
242416	Bonnet louver panel - front left	-	-	-	-	1
242419	Bonnet louver panel front medallion	-	-	-	-	2
234652	Bonnet louver panel - side right	3	-	-	-	-
225159	Bonnet louver panel - side right	-	2	-	-	-
316209	Bonnet louver panel - side right	-	-	4	-	-
234651	Bonnet louver panel - side left	3	-	-	-	-
316208	Bonnet louver panel - side left	-	-	4	-	-
225158	Bonnet louver panel - side left	-	2	-	-	-
6379	Bonnet louver panel screw No. 6-32 x 5/16 rnd. hd. machine	-	24	-	-	-
3516	Lockwasher No. 6	-	24	-	-	-
240090	Bonnet louver panel moulding	-	-	-	4	4
240264	Bonnet louver panel moulding clamp	-	-	-	16	16
6471	Screw No. 6-32	-	-	-	30	30
3516	Lockwasher No. 6	-	-	-	32	32
240263	Bonnet louver panel moulding screw cup washer No. 6	-	-	-	16	16
234894	Bonnet side left assembly (Specify color)	1	-	-	-	-
240078	Bonnet side left assembly (Specify color)	-	-	1	-	-
240076	Bonnet side left assembly	-	-	-	1	1
240075	Bonnet side right assembly	-	-	-	1	1

SERVICE PARTS LIST--PACKARD SUPER-EIGHT AND TWELVE

Bonnet 3

Piece No.	Name	1500	1506	1603	1607	1707	
		1501	1507	1604	1608	1708	
		1502	1508	1605	No. Required		
234895	Bonnet side right assembly (Specify color)	1	-	-	-	-	
240077	Bonnet side right assembly (Specify color)	-	-	1	-	-	
0231092	Bonnet side left and door assy. (Specify color)	-	1	-	-	-	
0231093	Bonnet side right and door assy. (Specify color)	-	1	-	-	-	
225363	Bonnet side bumper - center	2	-	-	-	-	
225351	Bonnet side bumper - center	-	2	-	-	-	
211205	Screw No. 10 (.186) x 1/2 rnd. hd. (Parker Kalon - Type Z)	4	4	-	-	-	
3866	Washer 3/16 "N" standard	4	4	-	-	-	
225950	Bonnet side check strap	2	2	-	-	-	
240622	Bonnet side check strap	-	-	2	2	2	
6393	Screw 1/4-28 x 13/16 rnd. hd.	2	-	2	2	2	
6394	Screw 1/4-28 x 13/16 rnd. hd.	-	2	-	-	-	
62065	Washer	2	2	2	2	2	
5502	Lockwasher 1/4	2	2	2	2	2	
230182	Bonnet side corner bumper left assembly	1	1	-	-	-	
230183	Bonnet side corner bumper right assembly	1	1	-	-	-	
240265	Bonnet side corner bumper assembly	-	-	2	2	2	
242607	Bonnet side corner bumper rear left	-	-	-	-	1	
242608	Bonnet side corner bumper rear right	-	-	-	-	1	
225394	Bonnet side door right assembly (Specify color)	-	5	-	-	-	
225393	Bonnet side door left assembly (Specify color).	-	5	-	-	-	
191157	Bonnet side door hinge rivet	-	20	-	-	-	
3905	Washer 1/8 special	-	20	-	-	-	
191161	Bonnet side door hinge washer	-	10	-	-	-	
228902	Bonnet side door spring	-	10	-	-	-	
225140	Bonnet side panel moulding - long	-	4	-	-	-	
225141	Bonnet side panel moulding - short	-	4	-	-	-	
6471	Screw	-	36	-	-	-	
5435	Washer	-	36	-	-	-	
3516	Lockwasher No. 6	-	36	-	-	-	
223071	Bonnet top - right - assembly (Specify color) .	1	-	-	-	-	
223069	Bonnet top - right - assembly (Specify color) .	-	1	-	-	-	
240232	Bonnet top - right - assembly (Specify color) .	-	-	1	1	1	
223072	Bonnet top - left - assembly (Specify color) ..	1	-	-	-	-	
240231	Bonnet top - left - assembly (Specify color) ..	-	-	1	1	1	
223070	Bonnet top - left - assembly (Specify color) ..	-	1	-	-	-	
3516	Lockwasher No. 6	-	36	-	-	-	
221910	Bonnet top center panel assembly (Specify color)	1	-	-	-	-	
221618	Bonnet top center panel assembly (Specify color)	-	1	-	-	-	
240098	Bonnet top center panel assembly (Specify color)	-	-	1	1	1	
221924	Bonnet top center panel hinge pin	2	-	-	-	-	
221640	Bonnet top center panel hinge pin	-	2	-	-	-	
240271	Bonnet top center panel hinge pin	-	-	2	2	2	
225441	Bonnet top center panel moulding	1	-	-	-	-	
225440	Bonnet top center panel moulding	-	1	-	-	-	
240688	Bonnet top center panel moulding	-	-	1	1	1	
225521	Bonnet top center panel moulding fastener	1	1	-	-	-	
240708	Bonnet top center panel moulding fastener	-	-	4	4	4	
225505	Bonnet top center panel moulding screw	5	6	-	-	-	
324905	Bonnet top center panel moulding screw No. 10-32	-	-	2	2	2	

4 Brake (Hand)

SERVICE PARTS LIST--PACKARD SUPER-EIGHT AND TWELVE

Piece No.	Name	1500	1506	1603	1607	1707	
		1501	1507	1604	1608	1708	
		1502	1508	1605	No. Required		
7003	Nut No. 10-32	5	6	2	2	2	
5500	Lockwasher No. 10	5	6	2	2	2	
223587	Bonnet top center panel moulding rear screw ...	1	1	-	-	-	
7003	Nut No. 10-32	1	1	-	-	-	
157435	Washer	1	1	-	-	-	
3867	Washer 3/16 plain	1	1	-	-	-	
5500	Lockwasher No. 10	1	1	-	-	-	
223473	Bonnet top center panel reinforcement -ft. liner	1	1	-	-	-	
240274	Bonnet top center panel reinforcement - ft. liner	-	-	1	1	1	
225531	Bonnet top center panel reinforcement - rr. liner	1	1	-	-	-	
240275	Bonnet top center panel reinforcement - rr. liner	-	-	1	1	1	
225929	Bonnet top center panel reinforcement screw ...	5	5	5	5	5	
7004	Nut 1/4-28	5	5	5	5	5	
5502	Lockwasher 1/4	5	5	5	5	5	
62065	Washer 1/4 special	5	5	5	5	5	
225518	Bonnet top moulding bumper	2	2	-	-	-	
240276	Bonnet top moulding bumper	-	-	2	2	2	
5579	Bonnet top moulding bumper retainer brad No. 19 x 3/4 taper head	2	2	2	2	2	

BRAKE (HAND)

237842	Brake equalizer lever	1	1	1	1	1
5506	Lockwasher 3/8	1	1	-	-	-
3884	Plain washer	1	1	1	1	1
202056	Spring washer	1	1	1	1	1
234646	Brake equalizer lever pin	1	1	1	1	1
4305	Cotter pin 1/8 x 7/8	1	1	1	1	1
232173	Brake equalizer plate	1	1	1	1	1
309834	Pin	1	1	1	1	1
4290	Cotter pin 3/32 x 5/8	1	1	1	1	1
232172	Brake equalizer retracting spring	1	1	1	1	1
239475	Brake lever assembly (Supersedes 237171)	1	1	1	1	-
242446	Brake lever assembly	-	-	-	-	2
7835	Bolt 3/8-24 x 1-9/16 hex. hd.	-	-	2	2	2
5506	Lockwasher 3/8	-	-	2	2	2
232190	Brake lever assembly bolt spacer	-	-	2	2	2
237192	Brake lever cable assembly	1	1	1	1	1
234886	Brake lever cable conduit clip - lower	1	1	1	1	1
5566	Bolt 5/16-24 x 1-1/8 long	1	1	1	1	1
6044	Lockwasher 5/16 (Shakeproof)	1	1	1	1	1
7005	Nut 5/16-24	1	1	1	1	1
303939	Screw 5/16-18 x 1/2 (Shakeproof)	2	2	2	2	2
240382	Brake lever cable conduit to dash clip	-	-	1	1	1
221509	Brake lever cable conduit to motor support channel clamp	1	1	1	1	1
5504	Lockwasher 5/16	2	2	2	2	2
7826	Screw 5/16-24 x 5/8 hex. hd.	2	2	2	2	2
232855	Brake lever cable conduit to motor support channel clamp insert	1	1	1	1	1

SERVICE PARTS LIST--PACKARD SUPER-EIGHT AND TWELVE

Brake (Hydraulic) 5

Piece No.	Name	1500	1506	1603	1607	1707	
		1501	1507	1604	1608	1708	
		1502	1508	1605	No. Required		
7516	Brake lever cable yoke end 3/8 adjustable (equalizer end)	1	1	1	1	1	
7006	Lock nut 3/8 plain standard	1	1	1	1	1	
7526	Yoke end pin 3/8 standard (equalizer end)	1	1	1	1	1	
4291	Brake lever cable yoke end pin cotter pin 3/32 x 3/4	2	2	2	2	2	
7525	Brake lever cable yoke end pin 5/16 standard (Hand lever end)	1	1	1	1	1	
190291	Spring washer	1	1	1	1	1	
0242340	Brake lever locking roller	-	-	1	1	1	
4187	Brake lever pivot rivet	-	-	1	1	1	
0242339	Brake lever release spring	-	-	1	1	1	
0242426	Brake lever release spoon spring	1	-	-	-	-	
232190	Brake lever sector spacer	2	2	-	-	-	
7835	Bolt 3/8-24 x 1-9/16 hex. hd.	2	2	-	-	-	
5506	Lockwasher 3/8	2	2	-	-	-	
315988	Brake lever rear wheel cable to frame clip	2	2	2	2	2	
304711	Brake lever rear wheel cable to frame clip screw 5/16-18 x 1/2 washer type	4	4	4	4	4	
232316	Brake lever rear wheel cable support plate and conduit assembly (Use on 1500-1603)	2	-	2	-	-	
232317	Brake lever rear wheel cable support plate and conduit assembly (Use on 1501-1604)	2	-	2	-	-	
232318	Brake lever rear wheel cable support plate and conduit assembly (Use on 1502-1605)	2	-	2	-	-	
232319	Brake lever rear wheel cable support plate and conduit assembly (Use on 1506)	-	2	-	-	-	
232320	Brake lever rear wheel cable support plate and conduit assembly (Use on 1507-1607-1707)	-	2	-	2	2	
232321	Brake lever rear wheel cable support plate and conduit assembly (Use on 1508-1608-1708)	-	2	-	2	2	
302943	Brake lever rear wheel cable to support plate clip	2	2	2	2	2	
7826	Screw 5/16-24 x 5/8 hex. hd.	4	4	4	4	4	
5504	Lockwasher 5/16	4	4	4	4	4	
302944	Brake lever rear wheel cable to support plate clip felt	2	2	2	2	2	
7515	Brake lever rear wheel cable yoke end (5/16 adjusting)	2	2	-	-	-	
242077	Brake lever rear wheel cable yoke end	-	-	2	2	2	
7005	Nut 5/16-24	2	2	2	2	2	
7525	Brake lever rear wheel cable yoke end pin 5/16	2	2	2	2	2	
4290	Cotter pin 3/32 x 5/8	2	2	2	2	2	

BRAKE (HYDRAULIC)

0304690	Brake fluid (Pints)	x	x	x	x	x
0304315	Brake fluid (Quarts)	x	x	x	x	x
0304316	Brake fluid (1-gallon)	x	x	x	x	x
0304317	Brake fluid (5-gallon)	x	x	x	x	x

6 Brake (Hydraulic)

SERVICE PARTS LIST--PACKARD SUPER-EIGHT AND TWELVE

Piece No.	Name	1500	1506	1603	1607	1707	
		1501	1507	1604	1608	1708	
		1502	1508	1605	No. Required		
234845	Brake assembly - front left	1	-	1	-	-	
234849	Brake assembly - front left	-	1	-	1	1	
234846	Brake assembly - front right	1	-	1	-	-	
234850	Brake assembly - front right	-	1	-	1	1	
234847	Brake assembly - rear left	1	-	1	-	-	
234851	Brake assembly - rear left	-	1	-	1	1	
234848	Brake assembly - rear right	1	-	1	-	-	
234852	Brake assembly - rear right	-	1	-	1	1	
234790	Brake - master cylinder assembly	1	-	1	-	-	
237618	Brake - master cylinder assembly	-	1	-	1	1	
7853	Screw 3/8-24 x 1-1/8 hex. hd.	3	3	3	3	3	
6048	Lockwasher 3/8 (Shakeproof)	3	3	3	3	3	
7006	Nut 3/8-24	3	-	3	-	-	
303007	Brake - master cylinder boot	1	1	1	1	1	
303011	Brake - master cylinder boot strap - small	1	1	1	1	1	
303004	Brake - master cylinder boot strap - large	1	1	1	1	1	
234861	Brake - master cylinder check valve assembly ..	1	1	1	1	1	
303019	Brake - master cylinder expansion plug	1	1	1	1	1	
303014	Brake - master cylinder filler plug assembly ..	1	1	1	1	1	
303015	Brake - master cylinder filler plug gasket	1	1	1	1	1	
234862	Brake - master cylinder head	1	-	1	-	-	
237386	Brake - master cylinder head	-	1	-	1	1	
303021	Brake - master cylinder head gasket	1	1	1	1	1	
302702	Brake - master cylinder outlet connection	1	1	1	1	1	
302495	Brake - master cylinder outlet connection bolt.	1	1	-	-	-	
316861	Brake - master cylinder outlet connection bolt.	-	-	1	1	1	
302496	Brake - master cylinder outlet connection gasket - outer	1	1	1	1	1	
302700	Brake - master cylinder outlet connection gasket - inner	1	1	1	1	1	
234863	Brake - master cylinder piston assembly	1	1	1	1	1	
234864	Brake - master cylinder piston	1	1	1	1	1	
234865	Brake - master cylinder piston cup	1	1	1	1	1	
234866	Brake - master cylinder piston cup protector ..	1	1	1	1	1	
234867	Brake - master cylinder piston push rod assy. .	1	1	1	1	1	
234868	Brake - master cylinder piston push rod connector	1	1	1	1	1	
237463	Brake - master cylinder piston push rod and extension assembly	1	-	1	-	-	
234869	Brake - master cylinder piston return spring and retainer assembly	1	1	1	1	1	
234870	Brake - master cylinder piston return spring ..	1	1	1	1	1	
234872	Brake - master cylinder piston stop	1	1	1	1	1	
234873	Brake - master cylinder piston stop lockwire ..	1	1	1	1	1	
234874	Brake - master cylinder and plug assembly	1	-	1	-	-	
237622	Brake - master cylinder and plug assembly	-	1	-	1	1	
0242503	Brake - master cylinder repair kit 1-1/8"	1	1	1	1	1	
234875	Brake - master cylinder secondary cup	1	1	1	1	1	
234876	Brake - master cylinder secondary cup ring	1	1	1	1	1	
232365	Brake - pedal	1	-	1	-	-	
232484	Brake - pedal	-	1	-	1	1	

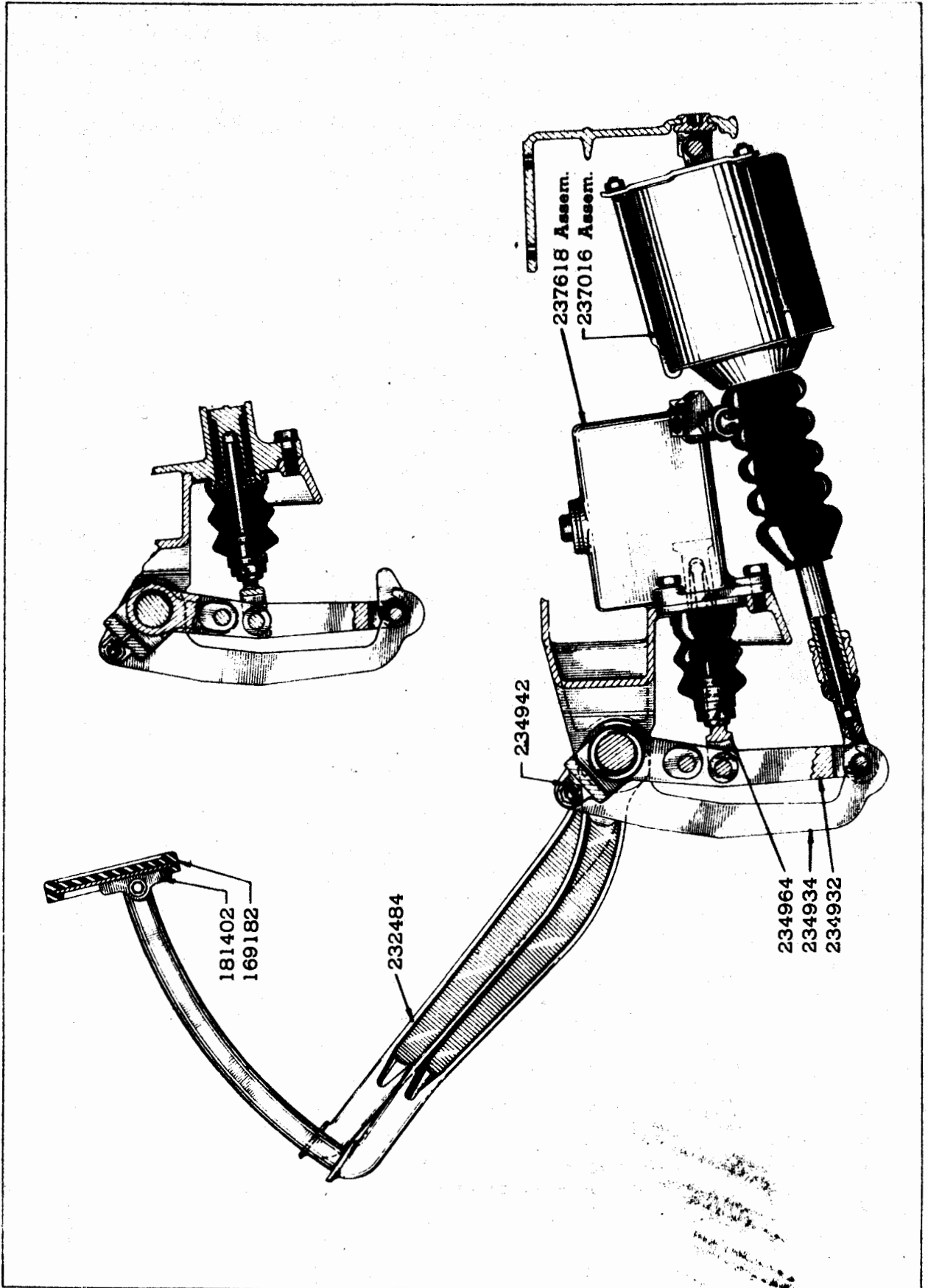

8 Brake (Hydraulic)

SERVICE PARTS LIST--PACKARD SUPER-EIGHT AND TWELVE

Piece No.	Name	1500	1506	1603	1607	1707
		1501	1507	1604	1608	1708
		1502	1508	1605	No. Required	
7820	Brake - pedal clamp screw 3/8-24 x 1-3/8 hex. hd.	-	1	-	1	1
6048	Lockwasher 3/8 (Shakeproof)	-	1	-	1	1
4554	Brake - pedal key	-	1	-	1	1
237181	Brake - pedal washer	-	1	-	1	1
232671	Brake - pedal connecting rod lock nut 7/16-20 (L.H. drive)	1	-	1	-	-
302413	Brake - pedal connecting rod screw (L.H. drive)	1	-	1	-	-
5728	Lockwasher 7/16 special (L.H. drive)	1	-	1	-	-
3877	Plain washer 3/8 (L.H. drive)	1	-	1	-	-
4304	Cotter pin 1/8 x 3/4 (L.H. drive)	1	-	1	-	-
234942	Brake - pedal lever	-	1	-	1	1
7869	Brake - pedal lever clamp screw 3/8-24 x 1-7/8 hex. hd.	-	1	-	1	1
6048	Lockwasher 3/8 (Shakeproof)	-	1	-	1	1
7006	Nut 3/8	-	1	-	1	1
4554	Brake - pedal lever key	-	1	-	1	1
234931	Brake - pedal lever to vacuum lever pin	-	1	-	1	1
207750	Spring washer	-	1	-	1	1
4291	Cotter pin 3/32 x 3/4	-	1	-	1	1
232979	Brake - pedal to master cylinder connector (L.H. drive)	1	-	1	-	-
239568	Brake - pedal pad assembly (Supersedes 181402).	1	1	-	-	-
240486	Brake - pedal pad assembly	-	-	1	1	1
8043	Brake - pedal pad lug screw 5/16-24 x 1-1/4 hex. hd.	1	1	-	-	-
5566	Brake - pedal pad lug screw 5/16-24 x 1-1/8 hex. hd.	1	1	1	1	1
7005	Nut 5/16-24	1	1	1	1	1
6044	Lockwasher 5/16 standard	1	1	1	1	1
169182	Brake - pedal pad tread	1	1	1	1	1
234885	Brake - pedal retracting spring	1	-	1	-	-
237383	Brake - pedal retracting spring	-	1	-	1	1
234932	Brake - pedal vacuum cylinder lever	-	1	-	1	1
234964	Brake - pedal vacuum cylinder lever to master cylinder yoke	-	1	-	1	1
232671	Yoke lock nut	-	1	-	1	1
7527	Yoke end pin	-	1	-	1	1
186436	Spring washer	-	1	-	1	1
4291	Cotter pin 3/32 x 3/4	-	1	-	1	1
4289	Brake - pedal vacuum cylinder lever to vacuum cylinder cotter pin 3/32 x 1/2	-	1	-	1	1
234934	Brake - pedal vacuum cylinder value operating lever	-	1	-	1	1
7872	Adjusting screw 3/8-24 x 3/4 hex. hd.	-	1	-	1	1
3877	Plain washer 3/8	-	1	-	1	1
6048	Lockwasher 3/8 (Shakeproof)	-	1	-	1	1
300335	Brake - pedal wick	1	-	1	-	-
303051	Brake - shoe adjusting screw	4	-	4	-	-
234825	Brake - shoe adjusting screw	-	4	-	4	4
209856	Brake - shoe adjusting screw pivot nut	-	4	-	4	4

SERVICE PARTS LIST--PACKARD SUPER-EIGHT AND TWELVE

Brake (Hydraulic) 9

Piece No.	Name	1500	1506	1603	1607	1707	
		1501	1507	1604	1608	1708	
		1502	1508	1605	No. Required		
303052	Brake - shoe adjusting screw pivot nut	4	-	4	-	-	
303053	Brake - shoe adjusting screw socket	4	-	4	-	-	
209817	Brake - shoe adjusting screw socket	-	4	-	4	4	
303063	Brake - shoe adjusting screw spring	4	-	4	-	-	
203902	Brake - shoe adjusting screw spring	-	4	-	4	4	
7010	Brake - shoe anchor pin nut 5/8-18	4	-	4	-	-	
7012	Nut 3/4-16	-	4	-	4	4	
303065	Brake - shoe anchor pin lockwasher	4	-	4	-	-	
237484	Brake - shoe anchor pin lockwasher	-	4	-	4	4	
237805	Brake - shoe anchor pin and shoe guide assembly	4	-	4	-	-	
237816	Brake - shoe anchor pin and shoe guide assembly	-	4	-	4	4	
303837	Brake - shoe anchor pin to (primary) shoe spring	4	-	4	-	-	
303836	Brake - shoe anchor pin to (secondary) shoe spring	4	-	4	-	-	
234834	Brake - shoe anchor pin to (primary) shoe spring	-	4	-	4	4	
239060	Brake - shoe anchor pin to (secondary) shoe spring	-	4	-	4	4	
239059	Brake - shoe (primary) to bracket spring	-	4	-	4	4	
304879	Brake - shoe (secondary) to bracket spring	4	4	4	4	4	
202699	Brake - shoe eccentric assembly	4	4	4	4	4	
202716	Brake - shoe eccentric stud	4	4	4	4	4	
5506	Lockwasher 3/8	4	4	4	4	4	
7006	Nut 3/8-24	4	4	4	4	4	
237893	Brake - shoe hold down spring	8	-	8	-	-	
237893	Brake - shoe hold down spring (bottom - front).	-	4	-	4	4	
303064	Brake - shoe hold down spring (bottom - rear) .	-	4	-	4	4	
210776	Brake - shoe hold down spring (top)	-	8	-	8	8	
202721	Brake - shoe hold down spring cup inner	8	16	8	16	16	
202747	Brake - shoe hold down spring cup outer	8	16	8	16	16	
237890	Brake - shoe hold down spring pin	8	-	8	-	-	
237889	Brake - shoe hold down spring pin (front)	-	8	-	8	8	
237891	Brake - shoe hold down spring pin (rear)	-	8	-	8	8	
0239086	Brake - shoe lining set (with rivets) (4-wheel)	1	-	1	-	-	
0239087	Brake - shoe lining set (with rivets) (4-wheel)	-	1	-	1	1	
0239142	Brake - shoe lining set (2-wheel)	1	-	1	-	-	
0239143	Brake - shoe lining set (2-wheel)	-	1	-	1	1	
0242643	Brake - shoe lining (primary and secondary) (Supersedes 234753 and 234754)	8	-	8	-	-	
303074	Rivet	x	-	x	-	-	
239335	Brake - shoe lining (primary) (Semi-rigid) (Supersedes 234755)	-	4	-	4	4	
234756	Brake - shoe lining (secondary) (Semi-rigid) ...	-	4	-	4	4	
0242644	Brake - shoe and lining assembly (primary and secondary) (Supersedes 237807-8)	8	-	8	-	-	
237803	Brake - shoe and lining assembly (primary)	-	4	-	4	4	
237804	Brake - shoe and lining assembly (secondary) ..	-	4	-	4	4	
202941	Brake - shoe lining rivet	-	136	-	136	136	
237877	Brake - shoe strut - left	1	-	1	-	-	
237878	Brake - shoe strut - right	1	-	1	-	-	
234815	Brake - shoe strut	-	2	-	2	2	
303060	Brake - shoe strut washer	2	2	2	2	2	

10 Brake (Hydraulic)

SERVICE PARTS LIST--PACKARD SUPER-EIGHT AND TWELVE

Piece No.	Name	1500	1506	1603	1607	1707	
		1501	1507	1604	1608	1708	
		1502	1508	1605	No. Required		
4291	Brake - shoe strut cotter pin 3/32 x 3/4	2	2	2	2	2	
234816	Brake - shoe strut lever - left	1	-	1	-	-	
234772	Brake - shoe strut lever - left	-	1	-	1	1	
234817	Brake - shoe strut lever - right	1	-	1	-	-	
234773	Brake - shoe strut lever - right	-	1	-	1	1	
237899	Brake - shoe strut lever pin	2	2	2	2	2	
237895	Brake - shoe strut lever pin spring washer	2	2	2	2	2	
7006	Brake - shoe strut lever pin nut 3/8-24	2	2	2	2	2	
4291	Brake - shoe strut lever pin cotter pin 3/32 x 3/4	2	2	-	-	-	
4289	Brake - shoe strut lever pin cotter pin 3/32 x 1/2	-	-	2	2	2	
5506	Brake - shoe strut lever pin lockwasher 3/8 ...	2	2	2	2	2	
302729	Brake - shoe strut to lever spring	2	2	2	2	2	
303061	Brake - shoe strut to shoe spring	2	2	2	2	2	
237710	Brake - support plate assembly - front left ...	1	-	1	-	-	
234830	Brake - support plate assembly - front left ...	-	1	-	1	1	
237711	Brake - support plate assembly - front right ..	1	-	1	-	-	
234831	Brake - support plate assembly - front right ..	-	1	-	1	1	
237712	Brake - support plate assembly - rear left	1	-	1	-	-	
234832	Brake - support plate assembly - rear left	-	1	-	1	1	
237713	Brake - support plate assembly - rear right ...	1	-	1	-	-	
234833	Brake - support plate assembly - rear right ...	-	1	-	1	1	
202719	Brake - support plate adjusting hold cover	4	4	4	4	4	
232020	Brake - support plate cable bracket screw plate	2	2	2	2	2	
7853	Brake - support plate (rear) screw 3/8-24 x 1-1/8 hex. hd.	16	-	16	-	-	
7951	Screw 7/16-20 x 1-1/4 hex. hd.	-	14	-	14	14	
7006	Nut 3/8-24	16	-	16	-	-	
7007	Nut 7/16-20	-	14	-	14	14	
5506	Lockwasher 3/8	16	-	16	-	-	
5508	Lockwasher 7/16	-	14	-	14	14	
234577	Brake - support plate (front) screw (int.)	2	-	2	-	-	
234578	Brake - support plate (front) screw (int.)	-	2	-	2	2	
302077	Brake - support plate (front) screw (short) ...	4	-	4	-	-	
232731	Brake - support plate (front) screw (short) ...	-	8	-	8	8	
234579	Brake - support plate (front) screw (long)	2	-	2	-	-	
234606	Brake - support plate (front) screw (long)	-	2	-	2	2	
7107	Nut 7/16-20 castle	4	8	4	8	8	
7108	Nut 1/2-20 castle	4	4	4	4	4	
4291	Cotter pin 3/32 x 3/4	8	12	8	12	12	
209676	Brake - support plate water seal and bracket assembly	-	4	-	4	4	
6731	Brake - support plate water seal bracket screw No. 10-32 x 1-1/2 fill. hd.	-	4	-	4	4	
231032	Nut No. 10-32	-	4	-	4	4	
234729	Brake - support plate water seal	4	-	4	-	-	
316188	Brake - support plate water seal spring	4	-	4	-	-	
232471	Brake - tube assembly (front end junction to brake hose - left)	1	-	1	-	-	
232369	Brake - tube assembly (front end junction to brake hose - left)	-	1	-	1	1	

SERVICE PARTS LIST--PACKARD SUPER-EIGHT AND TWELVE

Brake 11

Piece No.	Name	1500	1506	1603	1607	1707	
		1501	1507	1604	1608	1708	
		1502	1508	1605	No. Required		
232472	Brake - tube assembly (front end junction to brake hose - right)	1	-	1	-	-	
232370	Brake - tube assembly (front end junction to brake hose - right)	-	1	-	-	-	
240250	Brake - tube assembly (front end junction to brake hose - right)	-	-	-	1	1	
232371	Brake - tube assembly (master cylinder to front end junction)	1	-	1	-	-	
232372	Brake - tube assembly (master cylinder to front end junction)	-	1	-	-	-	
240251	Brake - tube assembly (master cylinder to front end junction)	-	-	-	1	1	
232373	Brake - tube assembly (master cylinder to rear axle junction) (Use on 1500-1603)	1	-	1	-	-	
232264	Brake - tube assembly (master cylinder to rear axle junction) (Use on 1506)	-	1	-	-	-	
232374	Brake - tube assembly (master cylinder to rear axle junction) (Use on 1501-1604)	1	-	1	-	-	
232265	Brake - tube assembly (master cylinder to rear axle junction) (Use on 1507-1607-1707)	-	1	-	1	1	
232375	Brake - tube assembly (master cylinder to rear axle junction) (Use on 1502-1605)	1	-	1	-	-	
232266	Brake - tube assembly (master cylinder to rear axle junction) (Use on 1508-1608-1708)	-	1	-	1	1	
232376	Brake - tube assembly (rear axle junction to rear wheel - left)	1	-	1	-	-	
232267	Brake - tube assembly (rear axle junction to rear wheel - left)	-	1	-	1	1	
232377	Brake - tube assembly (rear axle junction to rear wheel - right)	1	-	1	-	-	
232268	Brake - tube assembly (rear axle junction to rear wheel - right)	-	1	-	1	1	
302134	Brake - tube clip (frame front crossmember) (1/4 boltless - single)	2	2	2	2	2	
302134	Brake - tube clip (frame side left) 1/4 boltless	-	3	-	3	3	
302134	Brake - tube clip (frame) side sub-channel - front L.H. 1/4 boltless single	2	2	2	2	2	
302539	Brake - tube clip (rear axle)	3	3	3	3	3	
302725	Brake - tube clip (rear axle) screw 7/16-20 x 1/2 hex. hd.	1	1	1	1	1	
5806	Lockwasher 7/16 (Shakeproof)	1	1	1	1	1	
302703	Brake - tube front end junction assembly	1	1	-	-	-	
240536	Brake - tube front end junction assembly	-	-	1	1	1	
304711	Brake - tube front end junction assembly screw 5/16-18 x 1/2 hex. hd. washer type	1	1	1	1	1	
315829	Brake - tube hose assembly	3	3	3	3	3	
302701	Brake - tube hose assembly (front) gasket	2	2	2	2	2	
216724	Brake - tube hose clip	3	3	3	3	3	
302501	Brake - tube rear axle junction	1	1	1	1	1	
302701	Brake - tube rear axle junction gasket	1	1	1	1	1	

12 Brake

SERVICE PARTS LIST--PACKARD SUPER-EIGHT AND TWELVE

Piece No.	Name	1500	1506	1603	1607	1707
		1501	1507	1604	1608	1708
		1502	1508	1605	No. Required	
6443	Brake - tube rear axle junction screw 7/16-20 x 1 hex. hd.	1	1	1	1	1
5806	Lockwasher 7/16 (Shakeproof)	1	1	1	1	1
302492	Brake - tube union nut	12	12	12	12	12
209169	Brake - tube and wiring harness clip (frame side - left)	3	-	3	-	-
7710	Clip screw No. 10-32 x 5/8 fill. hd.	3	-	3	-	-
5500	Lockwasher No. 10	3	-	3	-	-
7003	Nut No. 10-32 thd.	3	-	3	-	-
237016	Brake - vacuum cylinder	-	1	-	1	1
237555	Brake - vacuum cylinder air hose	-	1	-	1	1
237557	Brake - vacuum cylinder air hose clamp	-	2	-	2	2
225482	Brake - vacuum cylinder air hose junction	-	2	-	2	2
237002	Brake - vacuum cylinder to bracket pin	-	1	-	1	1
4291	Cotter pin 3/32 x 3/4	-	1	-	1	1
237075	Brake - vacuum cylinder hose	-	1	-	1	1
215648	Brake - vacuum cylinder hose clamp assembly ...	-	2	-	2	2
225482	Brake - vacuum cylinder hose junction	-	1	-	1	1
237023	Brake - wheel cylinder assembly - front - left hand	1	1	1	1	1
237024	Brake - wheel cylinder assembly - front - right hand	1	1	1	1	1
237025	Brake - wheel cylinder assembly - rear - left hand	1	1	1	1	1
237026	Brake - wheel cylinder assembly - rear - right hand	1	1	1	1	1
6558	Brake - wheel cylinder assembly to support plate screw 5/16-18 ¹ / ₂ x 1/2	8	8	8	8	8
6044	Lockwasher 5/16 (Shakeproof)	8	8	8	8	8
237402	Brake - wheel cylinder front - right	1	1	1	1	1
237403	Brake - wheel cylinder front - left	1	1	1	1	1
237404	Brake - wheel cylinder rear - right	1	1	1	1	1
237405	Brake - wheel cylinder rear - left	1	1	1	1	1
302959	Brake - wheel cylinder bleeder screw	4	4	4	4	4
5500	Lockwasher 3/16	4	4	4	4	4
5631	Plug No. 10-32 x 1/4 rnd. hd.	4	4	4	4	4
237408	Brake - wheel cylinder boot - front	4	4	4	4	4
302970	Brake - wheel cylinder boot - rear	4	4	4	4	4
237409	Brake - wheel cylinder connecting link	8	8	8	8	8
311983	Brake - wheel cylinder connecting link rivet ..	8	8	8	8	8
302701	Brake - wheel cylinder - rear tube connector gasket	2	2	2	2	2
237410	Brake - wheel cylinder front cup	4	4	4	4	4
237411	Brake - wheel cylinder front cup spring	2	2	2	2	2
237413	Brake - wheel cylinder rear cup	4	4	4	4	4
302968	Brake - wheel cylinder rear cup spring	2	2	2	2	2
237412	Brake - wheel cylinder front piston	4	4	4	4	4
237414	Brake - wheel cylinder rear piston	4	4	4	4	4

SERVICE PARTS LIST--PACKARD SUPER-EIGHT AND TWELVE

Bumper 13

Piece No.	Name	1500	1506	1603	1607	1707	
		1501	1507	1604	1608	1708	
		1502	1508	1605	No. Required		
237406	Brake--wheel cylinder port screw No. 10-32 x 1/4 fill. hd.	4	4	4	4	4	
237407	Brake--wheel cylinder port screw gasket	4	4	4	4	4	
0242504	Brake wheel cylinder repair kit--rear 1-1/8" ..	1	1	1	1	1	
0242505	Brake wheel cylinder repair kit--front 1-1/4" .	1	1	1	1	1	
BUMPER							
232393	Bumper assembly--front	1	1	-	-	-	
232394	Bumper assembly--rear (without trunk rack) (Used with bodies 1003-12-13-14-15-23-32-33- 34-35-63-73-L394-L395)	1	1	-	-	-	
234796	Bumper assembly--rear (with trunk rack) (Used with bodies 1003-12-13-14-15-23-32-33-34-35- 63-73-L394-L395)	1	1	-	-	-	
232395	Bumper assembly--rear (without trunk rack) (Used with bodies 1007-16-17-27-36-37-38-39).	1	1	-	-	-	
232395	Bumper assembly--rear (without trunk rack) (Used with bodies 1018-19-38-39 with side wheel carriers)	1	1	-	-	-	
232396	Bumper assembly--rear (without trunk rack) (Used with bodies 1018-19-38-39 without side wheel carriers)	1	1	-	-	-	
234760	Bumper assembly--rear (with trunk rack) (Used with bodies 1007-16-17-18-19-27-36-37-38-39).	1	1	-	-	-	
7843	Bumper assembly--front and rear screw 1/2-20 x 1-1/2 hex. hd.	8	8	-	-	-	
7008	Nut 1/2-20	8	8	-	-	-	
5510	Lockwasher 1/2	8	8	-	-	-	
232397	Bumper guard	4	4	-	-	-	
232398	Bumper guard bolt	4	4	-	-	-	
0234794	Bumper guard bolt spacer (with trunk rack) (Used with bodies 1007-16-17-18-19-27-36- 37-38-39)	1	1	-	-	-	
7008	Nut 1/2-20	4	4	-	-	-	
5510	Lockwasher 1/2	4	4	-	-	-	
232399	Bumper guard spacer	4	4	-	-	-	
232233	Bumper--front grommet--right	1	1	-	-	-	
232234	Bumper--front grommet--left	1	1	-	-	-	
232236	Bumper--rear grommet (without trunk rack) (Use with bodies 1003-12-13-14-15-23-1063- 32-33-34-35-63-73-L394-L395)	2	2	-	-	-	
232237	Bumper--rear grommet (without trunk rack) (Used with bodies 1007-16-17-18-19-27-36- 37-38-39)	2	2	-	-	-	
234892	Bumper--rear grommet (with trunk rack)	2	2	-	-	-	
234653	Bumper medallion (with trunk rack) (Used with bodies 1003-12-13-14-15-23-32-33-34-35-63- 73-L394-L395)	2	2	-	-	-	

14 Bumper

SERVICE PARTS LIST--PACKARD SUPER-EIGHT AND TWELVE

Piece No.	Name	1500	1506	1603	1607	1707	
		1501	1507	1604	1608	1708	
		1502	1508	1605	No. Required		
234741	Bumper medallion bolt (with trunk rack) (Used with bodies 1003-12-13-14-15-23-32-33-34-35-63-73)	2	2	-	-	-	
234678	Bumper medallion spacer (with trunk rack) (Used with bodies 1003-12-13-14-15-23-32-33-34-35-63-73)	2	2	-	-	-	
7008	Nut 1/2-20 (with trunk rack) (Used with bodies 1003-12-13-14-15-23-32-33-34-35-63-73)	2	2	-	-	-	
5510	Lockwasher 1/2 (with trunk rack) (Used with bodies 1003-12-13-14-15-23-32-33-34-35-63-73)	2	2	-	-	-	
0232456	Bumper--front cross bar	1	1	-	-	-	
0232457	Bumper--rear cross bar (Used with bodies 1003-12-13-14-15-23-32-33-34-35-63-73)	1	1	-	-	-	
0232457	Bumper--rear cross bar (without trunk rack) (Used with bodies 1018-1019 without side wheel carriers)	1	-	-	-	-	
0232552	Bumper--rear cross bar (without trunk rack) (Used with bodies 1007-16-17-27-36-37-38-39)	1	1	-	-	-	
0232552	Bumper--rear cross bar (without trunk rack) (Used with bodies 1018-1019 with side wheel carriers)	1	-	-	-	-	
0234795	Bumper--rear cross bar (with trunk rack) (Used with bodies 1007-16-17-18-19-27-36-37-38-39)	1	1	-	-	-	
0232409	Bumper--front support bar inner	2	2	-	-	-	
0232407	Bumper--front support bar outer	2	2	-	-	-	
0232404	Bumper--rear support bar inner left (without trunk rack) (Used with bodies 1003-12-13-14-15-1023-32-33-34-35-63-73-L394-L395)	1	1	-	-	-	
0232557	Bumper--rear support bar inner right (without trunk rack) (Used with bodies 1003-12-13-14-15-23-32-33-34-35-63-73-L394-L395)	1	1	-	-	-	
0232553	Bumper--rear support bar inner left (without trunk rack) (Used with bodies 1007-16-17-27-36-37-38-39)	1	1	-	-	-	
0232555	Bumper--rear support bar inner right (without trunk rack) (Used with bodies 1007-16-17-27-36-37-38-39)	1	1	-	-	-	
0232553	Bumper--rear support bar inner left (without trunk rack) (Used with bodies 1018-1019 with side wheel carriers)	1	-	-	-	-	
0232555	Bumper--rear support bar inner right (without trunk rack) (Used with bodies 1018-1019 with side wheel carriers)	1	-	-	-	-	
0234693	Bumper--rear support bar inner left (without trunk rack) (Used with bodies 1018-1019 without side wheel carriers)	1	-	-	-	-	

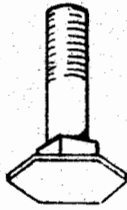

232398



0232406



232399

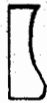

234678

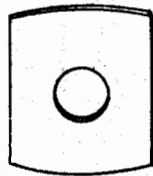

0234794



0234793



234741

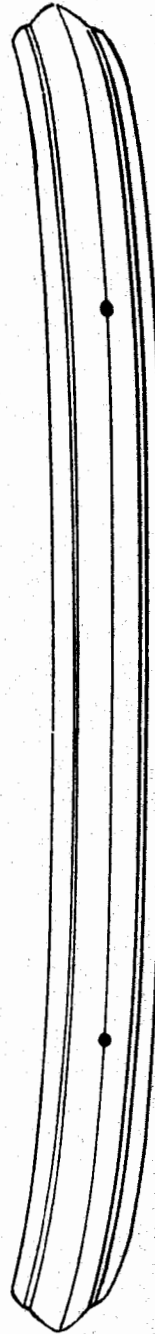

Bumper Cross Bar

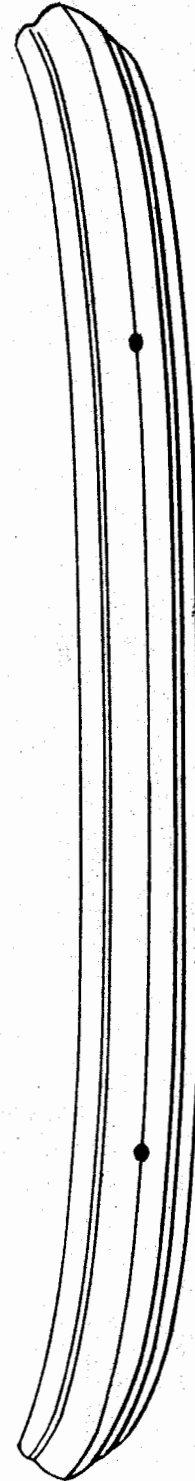

Bumper Assembly

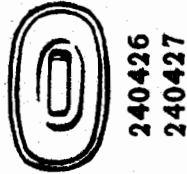

Support Bar
Outer-Right

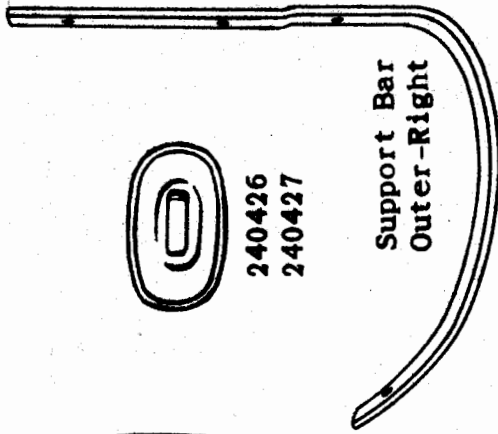

Support Bar
Inner-
Left Right

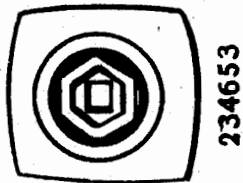
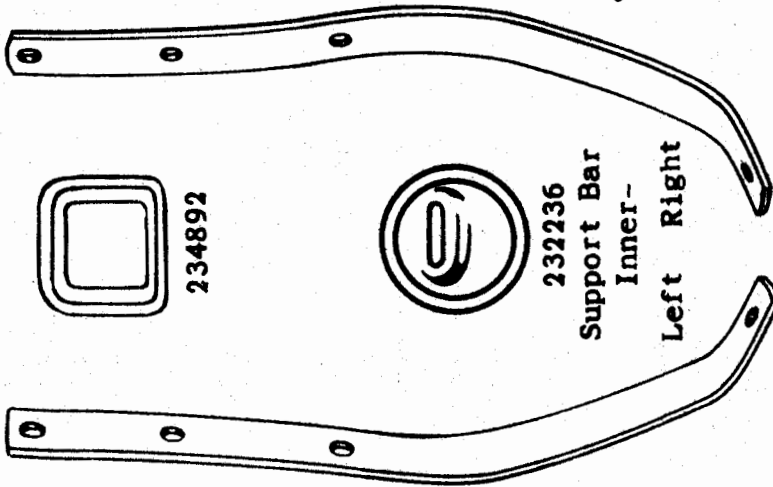

Support Bar
Outer-Left

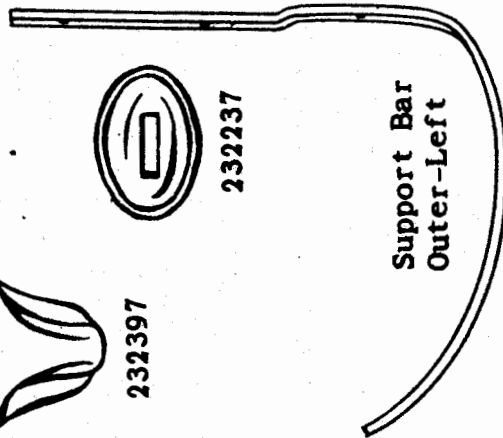
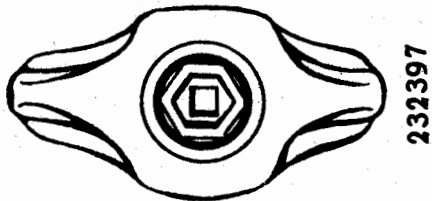

SERVICE PARTS LIST--PACKARD SUPER-EIGHT AND TWELVE

Bumper 17

Piece No.	Name	1500	1506	1603	1607	1707	
		1501	1507	1604	1608	1708	
		1502	1508	1605	No. Required		
0234696	Bumper--rear support bar inner right (without trunk rack) (Used with bodies 1018-1019 without side wheel carriers)	1	-	-	-	-	
0234786	Bumper--rear support bar inner left (with trunk rack) (Used with bodies 1003-12-13-14-15-23-32-33-34-35-63-73-L394-L395)	1	1	-	-	-	
0234787	Bumper--rear support bar inner right (with trunk rack) (Used with bodies 1003-12-13-14-15-23-32-33-34-35-63-73-L394-L395)	1	1	-	-	-	
0234758	Bumper--rear support bar inner left (with trunk rack) (Used with bodies 1007-16-17-18-19-27-36-37-38-39)	1	1	-	-	-	
0234791	Bumper--rear support bar inner right (with trunk rack) (Used with bodies 1007-16-17-18-19-27-36-37-38-39)	1	1	-	-	-	
0234793	Bumper--rear support bar inner to cross bar bolt (with trunk rack) (Used with bodies 1007-16-17-18-19-27-36-37-38-39)	2	2	-	-	-	
7008	Nut 1/2-20 (with trunk rack) (Used with bodies 1007-16-17-18-19-27-36-37-38-39)	2	2	-	-	-	
5510	Lockwasher 1/2 (with trunk rack) (Used with bodies 1007-16-17-18-19-27-36-37-38-39)	2	2	-	-	-	
0232405	Bumper--rear support bar outer left (without trunk rack) (Used with bodies 1003-12-13-14-15-23-32-33-34-35-63-73-L394-L395)	1	1	-	-	-	
0232558	Bumper--rear support bar outer right (without trunk rack) (Used with bodies 1003-12-13-14-15-23-32-33-34-35-63-73-L394-L395)	1	1	-	-	-	
0232554	Bumper--rear support bar outer left (without trunk rack) (Used with bodies 1007-16-17-27-36-37-38-39)	1	1	-	-	-	
0232556	Bumper--rear support bar outer right (without trunk rack) (Used with bodies 1007-16-17-27-36-37-38-39)	1	1	-	-	-	
0232554	Bumper--rear support bar outer left (without trunk rack) (Used with bodies 1018-1019 with side wheel carriers)	1	-	-	-	-	
0232556	Bumper--rear support bar outer right (without trunk rack) (Used with bodies 1018-1019 with side wheel carriers)	1	-	-	-	-	
0234694	Bumper--rear support bar outer left (without trunk rack) (Used with bodies 1018-1019 without side wheel carriers)	1	-	-	-	-	
0234697	Bumper--rear support bar outer right (without trunk rack) (Used with bodies 1018-1019 without side wheel carriers)	1	-	-	-	-	
0234788	Bumper--rear support bar outer left (with trunk rack) (Used with bodies 1003-12-13-14-15-23-32-33-34-35-63-73-L394-L395)	1	1	-	-	-	

18 Bumper

SERVICE PARTS LIST--PACKARD SUPER-EIGHT AND TWELVE

Piece No.	Name	1500	1506	1603	1607	1707
		1501	1507	1604	1608	1708
		1502	1508	1605	No. Required	
0234789	Bumper--rear support bar outer right (with trunk rack) (Used with bodies 1003-12-13-14-15-23-32-33-34-35-63-73-L394-L395)	1	1			
0234759	Bumper rear support bar outer left (with trunk rack) (Used with bodies 1007-16-17-18-19-27-36-37-38-39)	1	1			
0234792	Bumper rear support bar outer right (with trunk rack) (Used with bodies 1007-16-17-18-19-27-36-37-38-39)	1	1			
0232406	Bumper support bar outer to cross bar bolt	4	4			
7008	Nut 1/2-20	4	4			
5510	Lockwasher 1/2	4	4			

BUMPER

240490	Bumper assembly--front	-	-	1	1	1
240491	Bumper assembly--rear (Use without trunk rack). (Use with bodies 1103-1112-13-14-15-32-33-34-35-43-53-1232-33-34-35-53)	-	-	1	1	1
240545	Bumper assembly--rear (Use with trunk rack) (Use with bodies 1103-1112-13-14-15-32-33-34-35-43-53-1232-33-34-35-53)	-	-	1	1	1
240492	Bumper assembly--rear (Use without trunk rack) (Use with bodies 1107-16-17-27-36-37-1227-36-37)	-	-	1	1	1
240492	Bumper assembly--rear (Use without trunk rack) (Use with bodies 1118-38-19-39-1238-39 with side wheel carrier)	-	-	1	1	1
240493	Bumper assembly--rear (Use without rack) (Use with bodies 1118-19-38-39-1238-39 without side wheel carrier)	-	-	1	1	1
240544	Bumper assembly--rear (Use with trunk rack) (Use with bodies 1107-16-17-18-19-27-36-37-38-39--1227-36-37-38-39)	-	-	1	1	1
7843	Bumper assembly screw 1/2-20 x 1-1/2 hex. hd. .	-	-	8	8	8
5510	Lockwasher 1/2	-	-	8	8	8
7008	Nut 1/2-20	-	-	8	8	8
0240489	Bumper cross bar (Used with bumper 240492)	-	-	1	1	1
0240546	Bumper cross bar (Used with bumper 240544)	-	-	1	1	1
0240488	Bumper cross bar (Used with bumper 240545-240491-240493)	-	-	1	1	1
0240487	Bumper cross bar (Used with bumper 240490)	-	-	1	1	1

SERVICE PARTS LIST--PACKARD SUPER-EIGHT AND TWELVE

Bumper 19

Piece No.	Name	1500	1506	1603	1607	1707	
		1501	1507	1604	1608	1708	
		1502	1508	1605	No. Required		
232397	Bumper guard	-	-	4	4	4	
232398	Bumper guard bolt	-	-	4	4	4	
7008	Nut 1/2-20	-	-	4	4	4	
5510	Lockwasher 1/2	-	-	4	4	4	
0234794	Bumper guard bolt spacer - rear	-	-	2	2	2	
232399	Bumper guard spacer	-	-	4	4	4	
240426	Bumper grommet front left	-	-	1	1	1	
240427	Bumper grommet front right	-	-	1	1	1	
232236	Bumper grommet rear (Use with bodies 1103-12-13-14-15-32-33-34-35-43-53-1232-33-34-35-53) (Without trunk rack)	-	-	2	2	2	
232237	Bumper grommet rear (Use with bodies 1107-1116-17-18-19-27-36-37-38-39-1227-36-37-38-39) (Use without trunk rack)	-	-	2	2	2	
234892	Bumper grommet rear (Use with trunk rack)	-	-	2	2	2	
234653	Bumper medallion (Use with bumper 240545)	-	-	2	2	2	
234741	Bumper medallion bolt (Use with bumper 240545)	-	-	2	2	2	
234678	Bumper medallion spacer (Use with bumper 240545)	-	-	2	2	2	
0239708	Bumper support bar outer left (Used with bumper 240492)	-	-	1	1	1	
0239709	Bumper support bar outer right (Used with bumper 240492)	-	-	1	1	1	
0234759	Bumper support bar outer left (Used with bumper 240544)	-	-	1	1	1	
0234792	Bumper support bar outer right (Used with bumper 240544)	-	-	1	1	1	
0234788	Bumper support bar outer left (Used with bumper 240545)	-	-	1	1	1	
0234789	Bumper support bar outer right (Used with bumper 240545)	-	-	1	1	1	
0239700	Bumper support bar outer left (Used with bumper 240491)	-	-	1	1	1	
0239701	Bumper support bar outer right (Used with bumper 240491)	-	-	1	1	1	
0234694	Bumper support bar outer left (Used with bumper 240493)	-	-	1	1	1	
0234697	Bumper support bar outer right (Used with bumper 240493)	-	-	1	1	1	
0232407	Bumper support bar outer (Used with bumper 240490)	-	-	2	2	2	
0239710	Bumper support bar inner left (Used with bumper 240492)	-	-	1	1	1	
0239711	Bumper support bar inner right (Used with bumper 240492)	-	-	1	1	1	
0234758	Bumper support bar inner left (Used with bumper 240544)	-	-	1	1	1	
0234791	Bumper support bar inner right (Used with bumper 240544)	-	-	1	1	1	
0234786	Bumper support bar inner left (Used with bumper 240545)	-	-	1	1	1	

Piece No.	Name	1500	1506	1603	1607	1707	
		1501	1507	1604	1608	1708	
		1502	1508	1605	No. Required		
0234787	Bumper support bar inner right (Used with bumper 240545)	-	-	1	1	1	
0239702	Bumper support bar inner left (Used with bumper 240491)	-	-	1	1	1	
0239703	Bumper support bar inner right (Used with bumper 240491)	-	-	1	1	1	
0234693	Bumper support bar inner left (Used with bumper 240493)	-	-	1	1	1	
0234696	Bumper support bar inner right (Used with bumper 240493)	-	-	1	1	1	
0232409	Bumper support bar inner (Used with bumper 240490)	-	-	2	2	2	
0232406	Bumper support bar outer to cross bar bolt	-	-	2	2	2	
5510	Lockwasher 1/2	-	-	2	2	2	
7008	Nut 1/2-20	-	-	2	2	2	
0234793	Bumper support bar inner to cross bar bolt (Used with bumper 240544)	-	-	2	2	2	
5510	Lockwasher 1/2	-	-	2	2	2	
7008	Nut 1/2-20	-	-	2	2	2	

CLUTCH

231496	Clutch and brake pedal shaft	1	-	1	-	-
234950	Clutch and brake pedal shaft	-	1	-	1	1
237194	Clutch and brake pedal shaft bearing	-	2	-	2	2
237174	Clutch and brake pedal shaft bearing sleeve ...	-	2	-	2	2
237183	Clutch and brake pedal shaft bearing spacer ...	-	2	-	2	2
232847	Clutch and brake pedal shaft bracket	1	-	1	-	-
234968	Clutch and brake pedal shaft bracket sleeve assembly	-	1	-	1	1
5958	Clutch and brake pedal shaft bracket bolt 3/8-24 x 13/16 long	3	-	3	-	-
7006	Nut 3/8-24	3	-	3	-	-
6048	Lockwasher 3/8	1	-	1	-	-
213642	Clutch and brake pedal shaft to frame nut	1	-	1	-	-
232623	Clutch and brake pedal shaft to frame pilot washer	1	-	1	-	-
196881	Plain washer	1	-	1	-	-
5514	Lockwasher	1	-	1	-	-
237505	Clutch and brake pedal shaft support bolt spacer	1	-	1	-	-
237037	Clutch and brake vacuum cylinder air filter assembly	-	1	-	1	1
215478	Clutch cover plate assembly	1	-	1	-	-
221065	Clutch cover plate assembly	-	1	-	1	1
213387	Clutch cover plate	1	1	1	1	1
7818	Screw 3/8-24 x 7/8 hex. hd.	12	12	12	12	12
5506	Lockwasher 3/8	12	12	12	12	12
228514	Clutch cover plate spring cup	12	12	12	12	12
228527	Clutch cover plate spring cup rivet	12	12	12	12	12

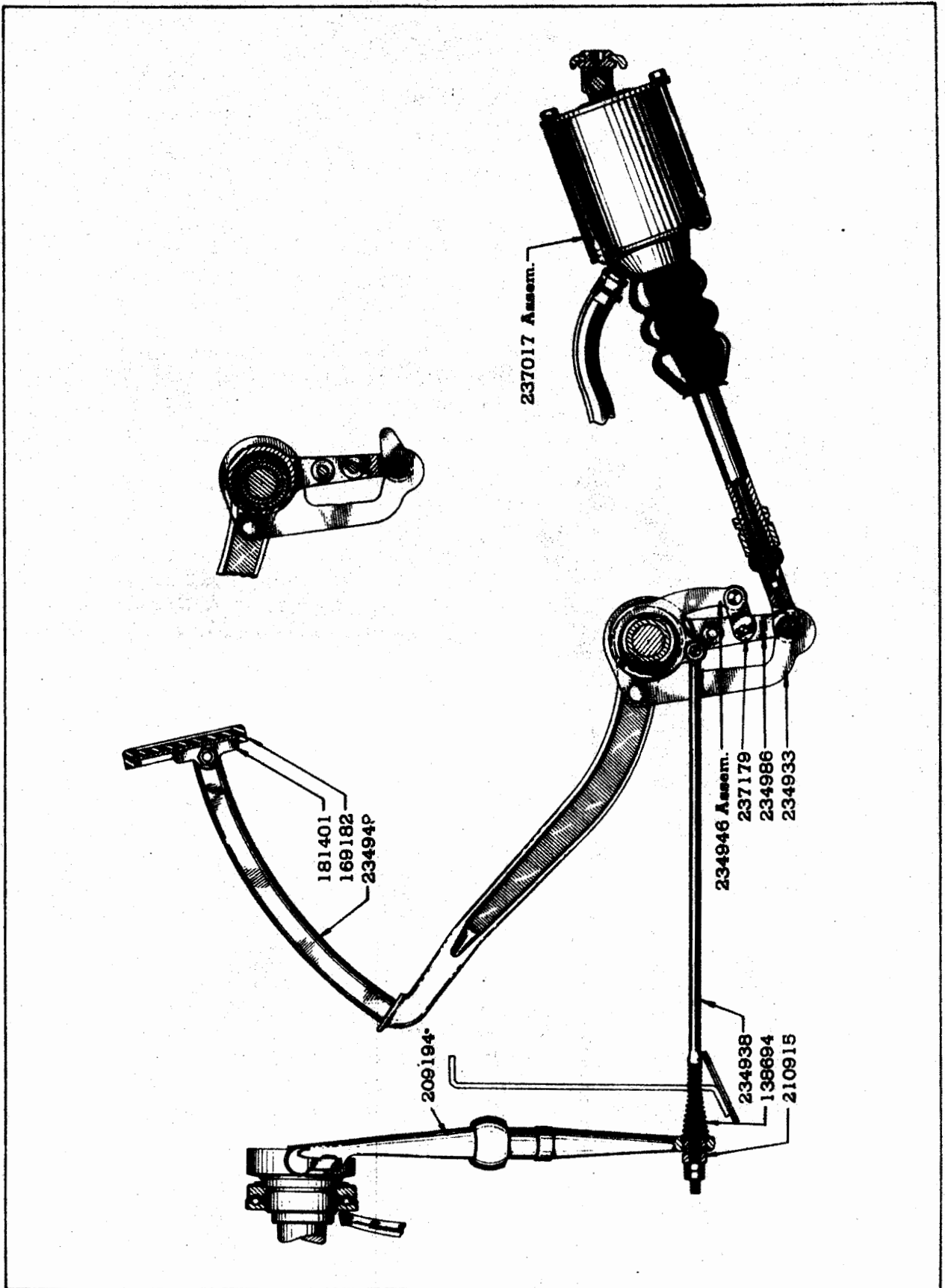

Models 1506-7-8

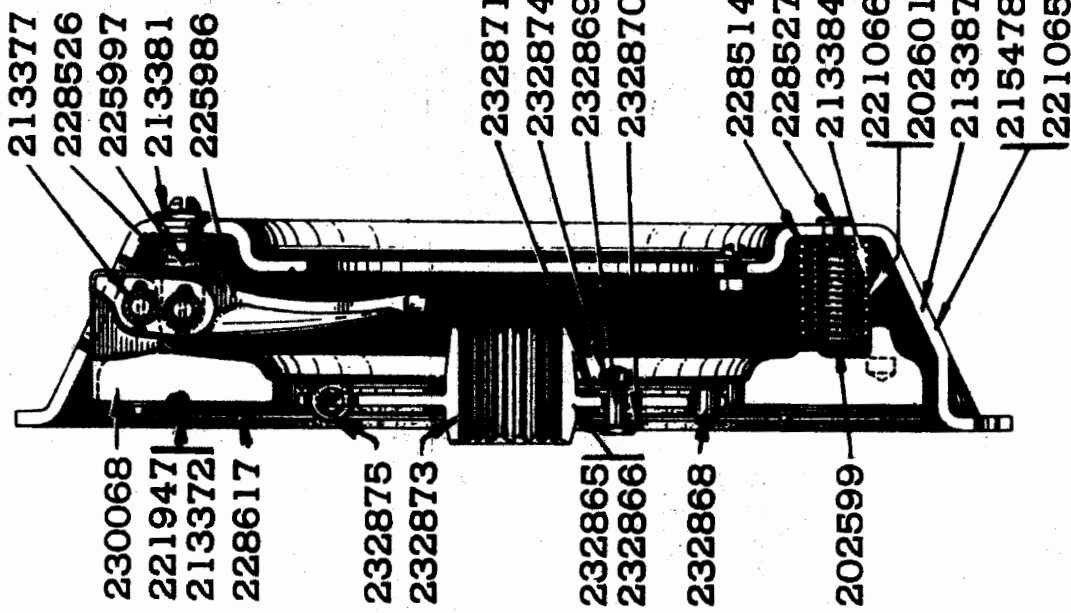
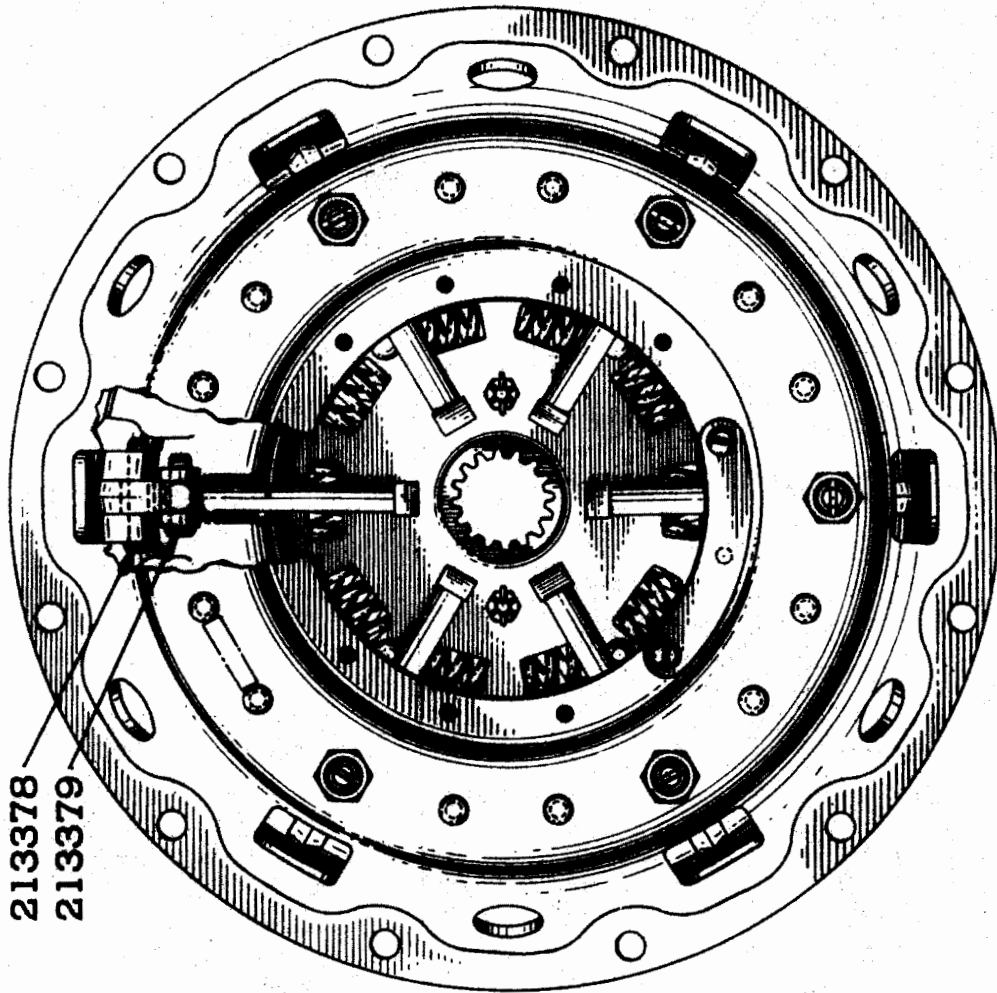

SERVICE PARTS LIST--PACKARD SUPER-EIGHT AND TWELVE

Clutch 23

Piece No.	Name	1500	1506	1603	1607	1707	
		1501	1507	1604	1608	1708	
		1502	1508	1605	No. Required		
221947	Clutch driven plate facing	2	-	2	-	-	
213372	Clutch driven plate facing	-	2	-	2	2	
228617	Clutch driven plate facing rivet	48	48	48	48	48	
232866	Clutch driven plate and hub assembly	-	1	-	1	1	
232865	Clutch driven plate and hub assembly	1	-	1	-	-	
232873	Clutch driven plate hub	1	1	1	1	1	
232869	Clutch driven plate hub bolt	4	4	4	4	4	
232874	Clutch driven plate hub bolt nut	4	4	4	4	4	
4280	Clutch driven plate hub bolt cotter pin 1/16 x 1/2	4	4	4	4	4	
232870	Clutch driven plate hub bolt spring	4	4	4	4	4	
232871	Clutch driven plate hub friction plate	2	2	2	2	2	
232875	Clutch driven plate hub spring	10	10	10	10	10	
302723	Clutch driven plate stop pin (Supersedes 232868)	4	4	4	4	4	
232278	Clutch pedal assembly	1	-	1	-	-	
234949	Clutch pedal assembly	-	1	-	1	1	
237173	Clutch pedal sleeve	-	1	-	1	1	
237194	Clutch pedal sleeve bearing	-	2	-	2	2	
237180	Clutch pedal sleeve washer	-	2	-	2	2	
232276	Clutch pedal bearing	2	-	2	-	-	
237194	Clutch pedal bearing	-	2	-	2	2	
234990	Clutch pedal bearing spacer	-	1	-	1	1	
232275	Clutch pedal bearing dust washer	2	-	2	-	-	
221260	Clutch pedal connecting rod assembly	1	-	1	-	-	
234938	Clutch pedal connecting rod assembly	-	1	-	1	1	
201504	Clutch pedal connecting rod yoke end pin (spring head)	1	-	1	-	-	
206825	Clutch pedal connecting rod yoke end pin plain washer	-	1	-	1	1	
190291	Clutch pedal connecting rod yoke end pin spring washer	2	2	2	2	2	
4289	Cotter pin 3/32 x 1/2	1	1	1	1	1	
210915	Clutch pedal connecting rod ball joint	1	1	1	1	1	
7405	Clutch pedal connecting rod adjusting nut 5/16-24	2	2	2	2	2	
138694	Clutch pedal connecting rod spring	1	1	1	1	1	
239567	Clutch pedal pad assembly (Supersedes 181401)	1	1	-	-	-	
240485	Clutch pedal pad assembly	-	-	1	1	1	
8043	Clutch pedal pad screw 5/16-24 x 1-1/4 hex. hd.	1	1	-	-	-	
5566	Clutch pedal pad screw 5/16-24 x 1-1/8 hex. hd.	1	1	1	1	1	
6044	Lockwasher 5/16	1	1	1	1	1	
7005	Nut 5/16-24	1	1	1	1	1	
169182	Clutch pedal pad tread	1	1	1	1	1	
309966	Clutch pedal retainer spring	1	-	1	-	-	
232277	Clutch pedal retainer spring washer	3	-	3	-	-	
4308	Cotter pin 1/8 x 1-1/4	1	-	1	-	-	
221987	Clutch pedal retracting spring	1	-	1	-	-	
239023	Clutch pedal retracting spring (Supersedes 237383)	-	1	-	1	1	
234986	Clutch pedal vacuum cylinder lever	-	1	-	1	1	
237249	Clutch pedal vacuum cylinder lever washer	-	1	-	1	1	

NOTE: CONSULT SERVICE BULLETINS FOR SERVICE EXCHANGES ON CLUTCH AND CLUTCH COVERS.

24 Clutch

SERVICE PARTS LIST--PACKARD SUPER-EIGHT AND TWELVE

Piece No.	Name	1500	1506	1603	1607	1707	
		1501	1507	1604	1608	1708	
		1502	1508	1605	No. Required		
234985	Clutch pedal vacuum cylinder lever pin	-	1	-	1	1	
4289	Clutch pedal vacuum cylinder lever to vacuum cylinder cotter pin 3/32 x 1/2	-	1	-	1	1	
239061	Clutch pedal vacuum cylinder lever to vacuum pin friction washer	-	1	-	1	1	
234933	Clutch pedal vacuum cylinder valve operating lever	-	1	-	1	1	
7872	Adjusting screw 3/8-24 x 3/4 hex. hd.	-	1	-	1	1	
3877	Plain washer 3/8	-	1	-	1	1	
6048	Lockwasher 3/8 (Shakeproof)	-	1	-	1	1	
230068	Clutch pressure plate	1	1	1	1	1	
202601	Clutch pressure spring	12	-	12	-	-	
213384	Clutch pressure spring--inner	-	12	-	12	12	
221066	Clutch pressure spring--outer	-	12	-	12	12	
202599	Clutch pressure spring insulator button	12	12	12	12	12	
225986	Clutch release lever	6	6	6	6	6	
4290	Cotter pin 3/32 x 5/8	12	12	12	12	12	
225997	Clutch release lever adjusting yoke	6	6	6	6	6	
213381	Clutch release lever adjusting yoke nut	6	6	6	6	6	
228526	Clutch release lever adjusting yoke spring	6	6	6	6	6	
213378	Clutch release lever pin--long	6	6	6	6	6	
213379	Clutch release lever pin--short	6	6	6	6	6	
213377	Clutch release lever roller	156	156	156	156	156	
234946	Clutch shifter operating lever assembly	-	1	-	1	1	
237179	Clutch shifter operating lever link	-	2	-	2	2	
7525	Yoke end pin	-	2	-	2	2	
4289	Cotter pin 3/32 x 1/2	-	2	-	2	2	
234984	Clutch shifter operating lever pin	-	1	-	1	1	
237017	Clutch vacuum cylinder	-	1	-	1	1	
237556	Clutch vacuum cylinder air hose	-	1	-	1	1	
237557	Clutch vacuum cylinder air hose clamp	-	2	-	2	2	
225482	Clutch vacuum cylinder air hose junction	-	2	-	2	2	
237002	Clutch vacuum cylinder to bracket pin	-	1	-	1	1	
4291	Cotter pin 3/32 x 3/4	-	1	-	1	1	
237215	Clutch vacuum cylinder hose	-	1	-	1	1	
215648	Clutch vacuum cylinder hose clamp assembly	-	2	-	2	2	
225482	Clutch vacuum cylinder hose junction	-	1	-	1	1	
221545	Clutch vacuum dash connection	-	1	-	1	1	
6482	Clutch vacuum dash connection screw 5/16-24 x 3/4 hex. hd.	-	1	-	1	1	
6044	Lockwasher 5/16 (Shakeproof)	-	1	-	1	1	
237177	Clutch vacuum tank assembly	-	1	-	1	1	
7826	Screw 5/16-24 x 5/8 hex. hd.	-	4	-	4	4	
6044	Lockwasher 5/16 (Shakeproof)	-	4	-	4	4	
223123	Clutch vacuum tank drain connection	-	1	-	1	1	
5421	Clutch vacuum tank drain plug 1/8 pipe hex. hd.	-	1	-	1	1	
223942	Clutch vacuum tank elbow	-	1	-	1	1	
237203	Clutch vacuum tank tube assembly	-	1	-	1	1	
5465	Union nut 1/2 flared	-	1	-	1	1	
6263	Nut 1/2 flared tube inverted	-	1	-	1	1	
228850	Clutch vacuum tank tube to frame clip	-	1	-	1	1	

SERVICE PARTS LIST--PACKARD SUPER-EIGHT AND TWELVE

Control 25

Piece No.	Name	1500	1506	1603	1607	1707	
		1501	1507	1604	1608	1708	
		1502	1508	1605	No. Required		
229302	Clutch vacuum tank tube to frame clip screw 1/4-20 x 1/2 hex. hd.	-	1	-	1	1	
237214	Clutch vacuum tube and dash connection assembly (Use with cane shift steering)	-	1	-	1	1	
6263	Nut 1/2 flared tube inverted (Use with cane shift steering).....	-	1	-	1	1	
242850	Clutch vacuum tube assembly - lower (Used on 1232-33-34-35-36-37-38)	-	-	-	-	1	
242857	Clutch vacuum tube assembly - lower (Used on 1227-39-53)	-	-	-	-	1	
242846	Clutch vacuum tube assembly - upper (Use with column shift steering)	-	-	-	-	1	
6263	Clutch nut 1/2 flared tube inverted	-	-	-	-	1	
242853	Clutch vacuum tube hose	-	-	-	-	1	
215649	Clutch vacuum tube hose clamp	-	-	-	-	2	
228850	Clutch vacuum tube and dash connection to dash clip	-	1	-	1	1	
167261	Screw 3/8 Parker Kalon binding hd.	-	1	-	1	1	
6697	Clutch vacuum tube tee 1/2 flared tube inverted	-	1	-	1	1	

CONTROL

232572	Control accelerator cross shaft assembly	1	-	-	-	-
240286	Control accelerator cross shaft assembly	-	-	1	-	-
232585	Control accelerator cross shaft assembly	-	1	-	-	-
240287	Control accelerator cross shaft assembly	-	-	-	1	1
206825	Control accelerator cross shaft washer 5/16 spl.	2	2	2	2	2
300693	Control accelerator cross shaft groove pin	1	1	1	1	1
300700	Control accelerator cross shaft anti-rattler spring	1	1	1	1	1
232368	Control accelerator cross shaft bracket--left .	1	1	1	1	1
232490	Control accelerator cross shaft bracket--right.	1	1	1	1	1
5873	Screw 1/4-28 x 9/16 hex. hd.	4	4	4	4	4
5502	Lockwasher 1/4 std.	4	4	4	4	4
237013	Control accelerator cross shaft cable lever stop	1	1	1	1	1
237836	Control accelerator cross shaft cable stop set screw No. 8-32 x 1/4 hex. hd.	1	1	1	1	1
232482	Control accelerator cross shaft carburetor throttle lever	1	-	1	-	-
232500	Control accelerator cross shaft carburetor throttle lever	-	1	-	-	-
240284	Control accelerator cross shaft carburetor throttle lever	-	-	-	1	1
300693	Control accelerator cross shaft carburetor throttle lever groove pin	1	1	1	1	1
237012	Control accelerator pedal	1	1	1	1	1
237004	Control accelerator pedal hinge (L.H. drive) ..	1	1	1	1	1
5963	Screw 1/4 x 7/16 countersunk (L.H. drive).	2	2	2	2	2
5396	Lockwasher 1/4 (Shakeproof) countersunk (L.H. drive)	2	2	2	2	2

Piece No.	Name	1500	1506	1603	1607	1707	
		1501	1507	1604	1608	1708	
		1502	1508	1605	No. Required		
237010	Control accelerator pedal hinge pin (L.H. drive)	1	1	1	1	1	
194732	Control accelerator pedal hinge pin spring washer (L.H. drive)	2	2	2	2	2	
237015	Control accelerator pedal hinge groove pin 5/64 x 1/2 (L.H. drive)	1	1	1	1	1	
311655	Control accelerator pedal push rod (L.H. drive)	1	1	1	1	1	
3907	Washer 1/4 "Y" std. (L.H. drive)	1	1	1	1	1	
4280	Cotter pin 1/16 x 1/2 (L.H. drive)	1	1	1	1	1	
237008	Control accelerator pedal push rod socket (L.H. drive)	1	1	1	1	1	
237009	Control accelerator pedal push rod socket retainer (15/16 plain washer) (L.H. drive) ..	1	1	1	1	1	
338580	Control accelerator pedal push rod weather seal (L.H. drive) (Supersedes 304281)	1	1	1	1	1	
232340	Control carburetor throttle connecting rod assembly	1	-	-	-	-	
240401	Control carburetor throttle connecting rod assembly	-	-	1	-	-	
232492	Control carburetor throttle connecting rod	-	1	-	1	1	
3906	Washer 3/16 "Y" std.	1	-	-	-	-	
4690	Control carburetor throttle connecting rod cotter pin 1/16 x 3/8	1	-	-	-	-	
143143	Ball joint	-	2	-	2	2	
7003	Nut No. 10-32	-	2	-	2	2	
5500	Lockwasher No. 10	-	2	-	2	2	
7513	Control carburetor throttle connecting rod yoke end adjusting 3/16	1	-	1	-	-	
7003	Nut No. 10-32	1	-	1	-	-	
7523	Yoke end pin 3/16	1	-	1	-	-	
4280	Cotter pin 1/16 x 1/2	1	-	1	-	-	
232485	Control carburetor throttle connecting rod retracting spring	1	1	1	1	1	
232486	Control carburetor throttle connecting rod retracting spring lever	-	1	-	-	-	
240285	Control carburetor throttle connecting rod retracting spring lever	-	-	-	1	1	
300693	Control carburetor throttle connecting rod retracting spring lever pin	-	1	-	1	1	
232504	Control instrument board throttle connecting cable bracket	1	1	1	1	1	
5576	Control instrument board throttle connecting cable bracket clamping screw No. 10-32 x 5/8 fill. hd.	1	1	1	1	1	
7003	Nut No. 10-32	1	1	1	1	1	
232725	Control-motor ignition coil cable dash grommet.	1	1	-	-	-	
207829	Control-motor ignition coil cable dash grommet retainer	1	1	-	-	-	
5984	Screw No. 6 x 3/8 rnd. hd.	3	3	-	-	-	

SERVICE PARTS LIST--PACKARD SUPER-EIGHT AND TWELVE

Electrical 27

Piece No.	Name	1500	1506	1603	1607	1707
		1501	1507	1604	1608	1708
		1502	1508	1605	No. Required	
ELECTRICAL						
230345	Electrical-battery (6 volt)	1	1	1	1	1
242142	Electrical-battery (12 volt)	-	-	1	-	-
232324	Electrical-battery carrier	1	1	1	1	1
232357	Electrical-battery clamp (with 6 volt battery).	2	2	2	2	2
242144	Electrical-battery clamp assembly (Use with 12 bolt battery)	-	-	1	-	-
316167	Electrical-battery to ground cable assembly ...	1	1	1	1	-
338735	Electrical-battery to ground cable assembly ...	-	-	-	-	1
5958	Screw 3/8-24 x 13/16 hex. hd.	1	1	1	1	1
3877	Washer 3/8 "N" std.	1	1	1	1	1
7006	Nut 3/8-24	1	1	1	1	1
5506	Lockwasher 3/8	1	1	1	1	1
338691	Electrical battery to ground cable terminal (battery end positive)	-	-	-	-	1
232262	Electrical-battery to starter switch cable assembly (with 6 volt equipment)	1	-	1	-	-
240657	Electrical-battery to starter switch cable assembly	-	-	-	1	1
242145	Electrical-battery to starter switch cable assembly (with 12 volt equipment)	-	-	1	-	-
232263	Electrical-battery to starter switch cable and wiring right assembly	-	1	-	-	-
203905	Electrical-battery to starter switch cable clip	-	1	-	1	1
201570	Electrical-battery to starter switch cable clip	-	3	1	3	3
6736	Screw No. 10-32 x 7/8 hex. hd.	-	3	-	3	3
5198	Screw No. 10-32 x 5/8 hex. hd.	-	-	1	-	-
7003	Nut No. 10-32	-	3	1	3	3
5500	Lockwasher No. 10 std.	-	3	1	3	3
3867	Washer 3/16 x 5/8	-	3	1	3	3
237882	Electrical-battery to starter switch cable dash grommet	-	1	-	1	1
225514	Electrical-battery to starter switch cable insulator	1	-	1	-	-
237201	Electrical-battery to starter switch cable insulator	-	1	-	-	-
242141	Electrical-battery to starter switch cable insulator	-	-	-	1	1
232601	Electrical-battery to starter switch cable insulator	-	1	-	-	-
242140	Electrical-battery to starter switch cable insulator	-	-	-	1	1
302124	Electrical-battery to starter switch cable terminal (Battery end negative) (with 6 volt equipment)	1	1	1	1	1
242146	Electrical-battery to starter switch cable terminal (Battery end negative) (with 12 volt equipment)	-	-	1	-	-
140076	Electrical-battery to starter switch cable terminal (switch end)	1	1	1	1	1

Piece No.	Name	1500	1506	1603	1607	1707	
		1501	1507	1604	1608	1708	
		1502	1508	1605	No. Required		
232202	Electrical-battery support front assembly	1	1	1	1	1	
232201	Electrical-battery support rear assembly (Use on 1500-1506-1603-1606)	1	1	1	1	1	
232287	Electrical-battery support rear assembly (Use on 1501-1507-1604-1607-1707)	1	1	1	1	1	
232285	Electrical-battery support rear assembly (Use on 1502-1508-1605-1608-1708)	1	1	1	1	1	
300917	Electrical-battery support bolt (Screw 3/8-24 x 13/16 hex. hd.)	4	4	-	-	-	
7818	Electrical-battery support bolt (Screw 3/8-24 x 7/8 hex. hd.)	-	-	4	4	4	
5506	Lockwasher 3/8	4	4	4	4	4	
7006	Nut 3/8-24	4	4	4	4	4	
232203	Electrical-battery support stud	4	4	4	4	4	
7305	Nut 5/16-18	4	4	4	4	4	
6048	Lockwasher 5/16	4	4	4	4	4	
216945	Electrical-battery terminal grease retainer ...	2	2	2	2	2	
201458	Electrical-cable (battery) (B and S Ga. No. 0).	x	x	x	x	x	
207477	Electrical-cable (high tension)	x	x	x	x	x	
216206	Electrical-cable No. 8 gauge (Red braid)	x	x	x	x	x	
216205	Electrical-cable No. 8 gauge (Black braid)	x	x	x	x	x	
179250	Electrical-cable No. 12 gauge (Black braid) ...	x	x	x	x	x	
166403	Electrical-cable No. 12 gauge (Red braid)	-	-	x	x	x	
194198	Electrical-cable No. 14 gauge (Black braid) ...	x	x	x	x	x	
194218	Electrical-cable No. 14 gauge (Red braid)	x	x	x	x	x	
225374	Electrical-cable No. 14 gauge (Yellow braid) ..	x	x	x	x	x	
194219	Electrical-cable No. 14 gauge (Green braid) ...	x	x	x	x	x	
209129	Electrical-cable No. 14 gauge (White braid) ...	x	x	x	x	x	
202223	Electrical-cable No. 14 gauge (Brown braid) ...	x	x	x	x	-	
225370	Electrical-cable No. 18 gauge (Red braid)	x	x	-	-	-	
237213	Electrical-cable No. 18 gauge (Green braid) (R.H. drive)	x	-	-	-	-	
166404	Electrical-cable No. 16 gauge (Black braid) ...	x	x	x	x	x	
225371	Electrical-cable No. 18 gauge (Brown braid) ...	x	x	x	x	x	
225372	Electrical-cable No. 18 gauge (White braid) ...	x	x	-	-	-	
225373	Electrical-cable No. 18 gauge (Tan with red and black tracer)	x	x	x	x	x	
166405	Electrical-cable No. 16 gauge (Black braid with red tracer)	x	x	x	x	x	
240668	Electrical-cable connector (2 wire)	-	-	12	14	14	
240669	Electrical-cable connector (3 wire)	-	-	4	4	4	
240635	Electrical-cable connector tip-male	-	-	23	23	23	
201736	Electrical-cable connector tip-male	5	5	-	-	-	
201737	Electrical-cable connector tip-female	14	14	-	-	-	
71397	Electrical-cable terminal 7/32 eye	12	12	26	25	25	
317805	Electrical-cable terminal-open end side eye ...	-	-	2	2	2	
166872	Electrical-cable terminal 7/32 eye	-	-	1	1	1	
171863	Electrical-cable terminal 13/32, side eye	-	-	1	1	1	
225377	Electrical-cable terminal 11/64 eye	-	-	1	1	1	
225376	Electrical-cable terminal 11/64 eye (Open end).	10	10	-	-	-	
33287	Electrical-cable terminal 13/64 eye	15	16	8	9	9	
225377	Electrical-cable terminal 11/64 eye	3	3	-	-	-	

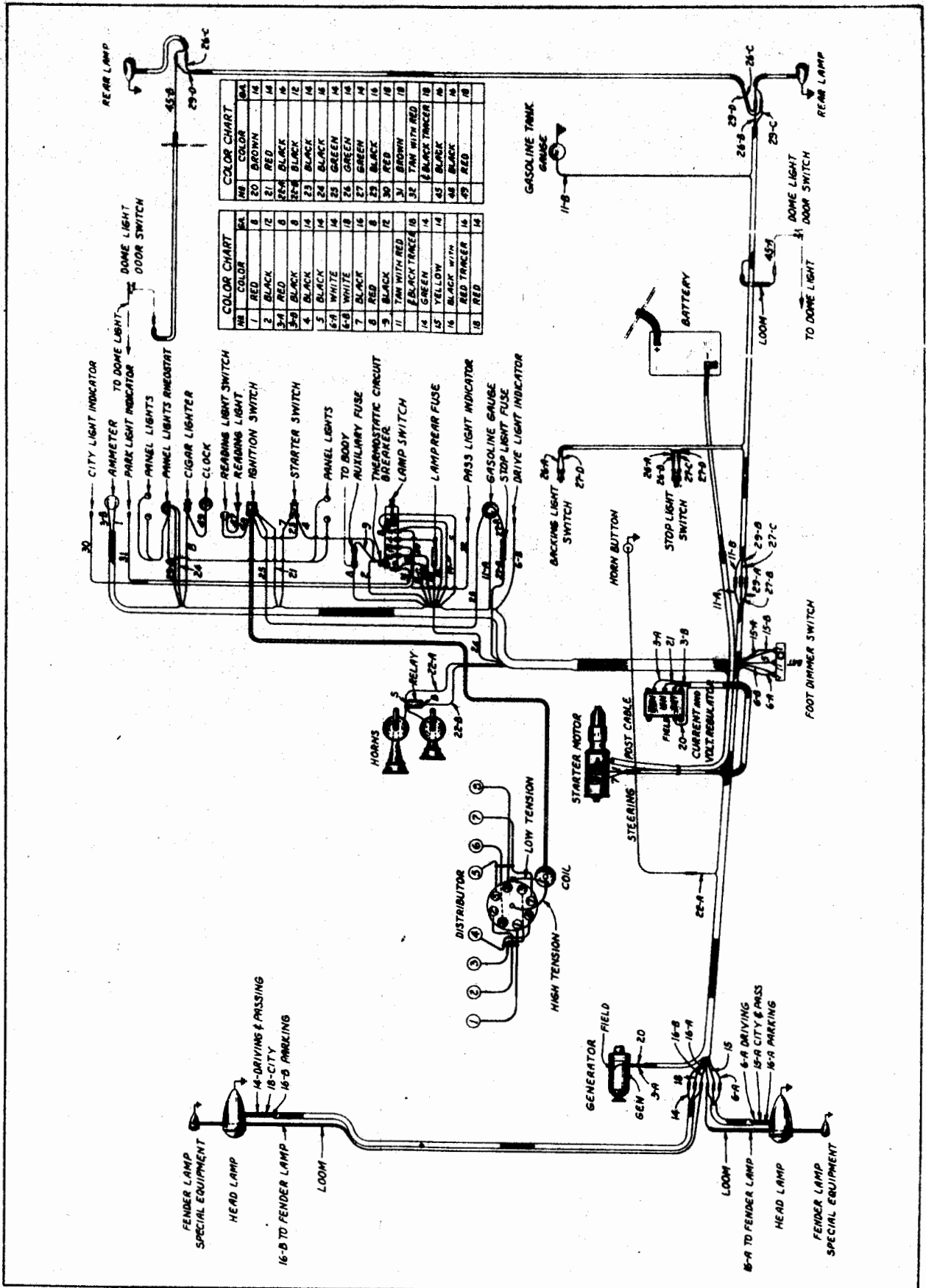

Models 1500-1-2

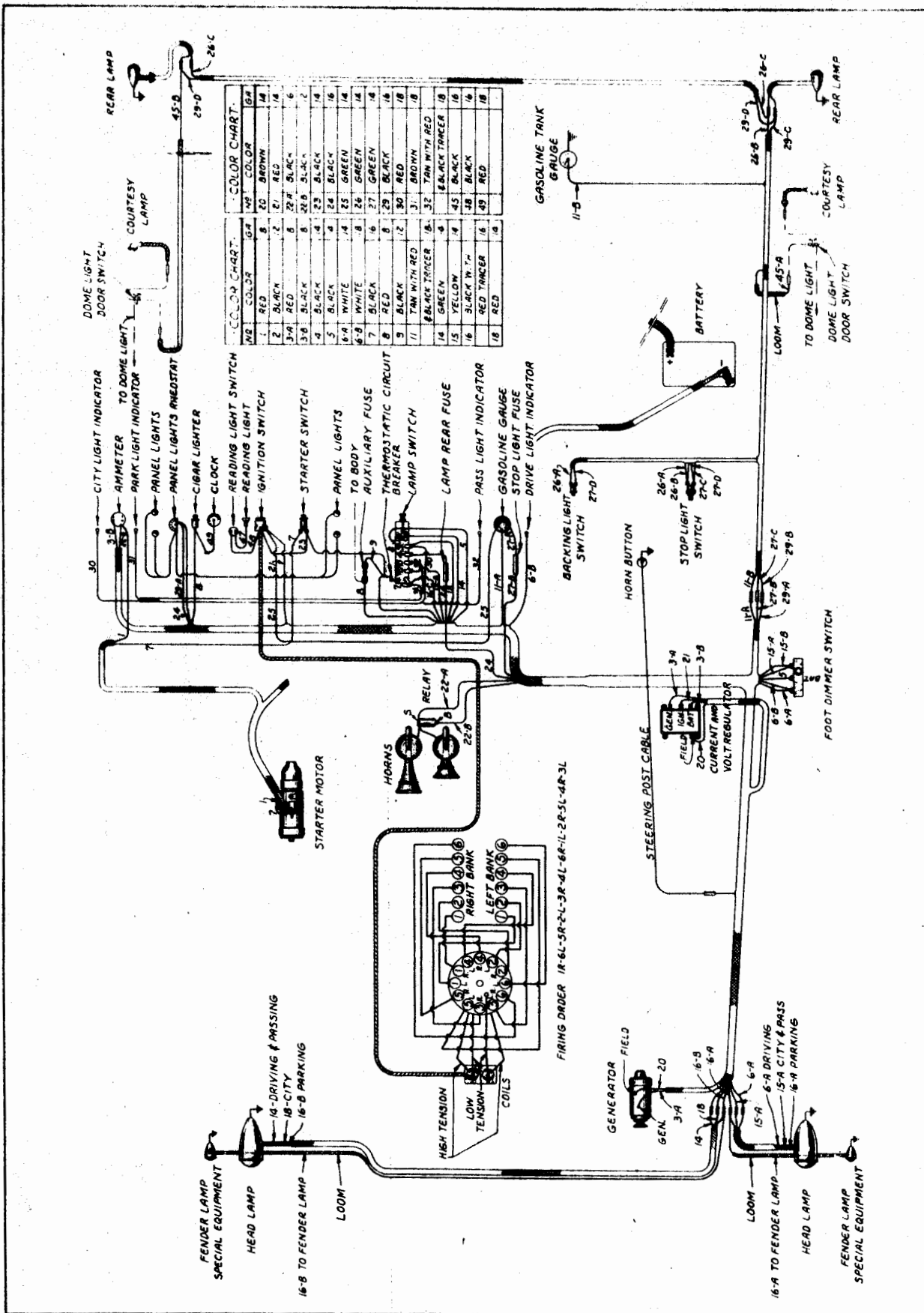

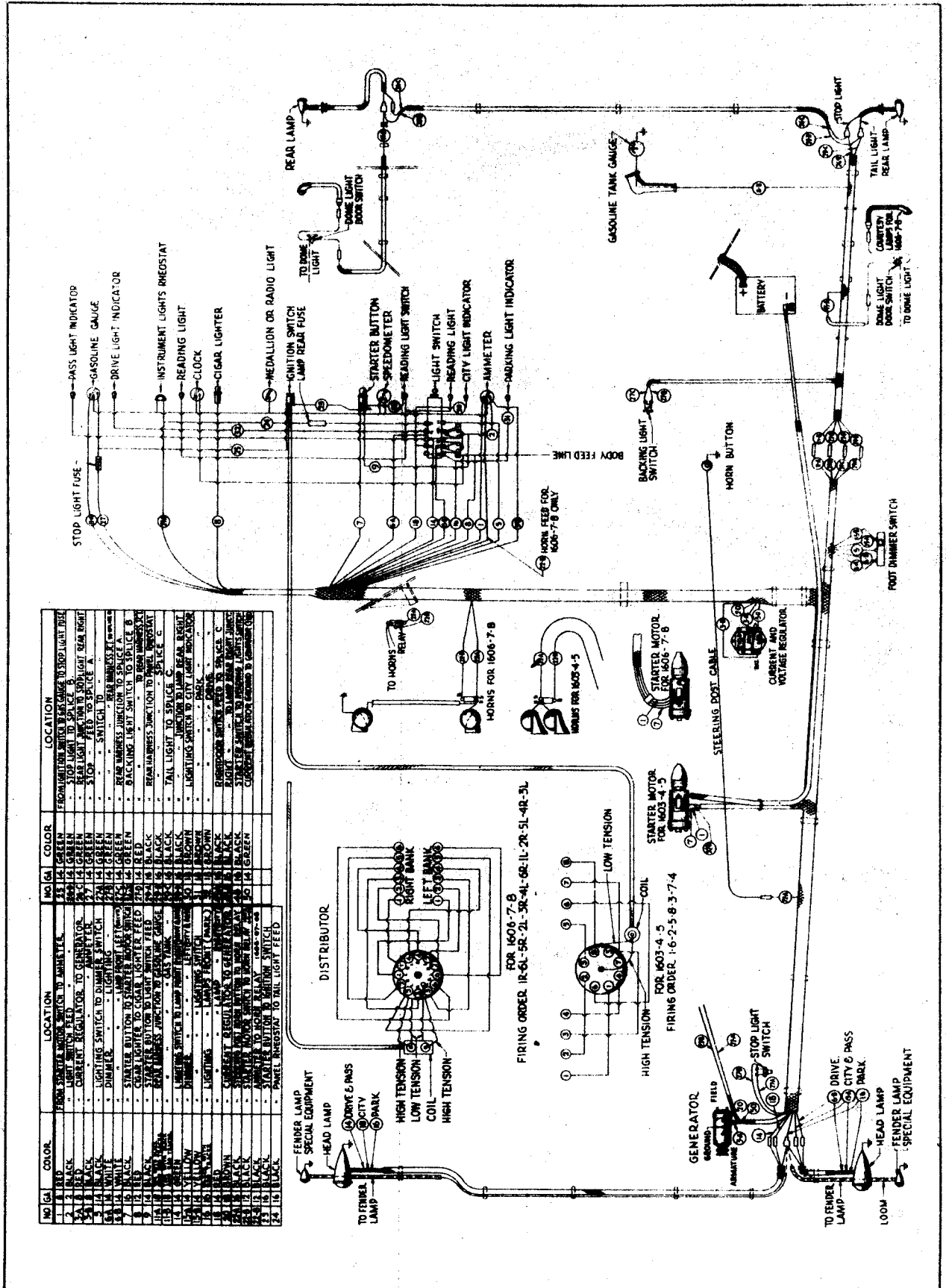

NO	COLOR	LOCATION	NO	COLOR	LOCATION
1	RED	FROM STARTER MOTOR SWITCH TO AMMETER	23	GREEN	FROM INSTRUMENT SWITCH TO GAS GAUGE TO STOP LIGHT FUSE
2	BLACK	TO LIGHT SWITCH TO SPICE B	24	GREEN	STOP LIGHT TO SPICE B
3	BLACK	TO LIGHT SWITCH TO SPICE A	25	GREEN	REAR LIGHT AND STOP LIGHT REAR RIGHT
4	BLACK	TO LIGHT SWITCH TO SPICE C	26	GREEN	REAR LIGHT AND STOP LIGHT REAR LEFT
5	BLACK	TO LIGHT SWITCH TO SPICE D	27	GREEN	STOP LIGHT TO SPICE A
6	BLACK	TO LIGHT SWITCH TO SPICE E	28	GREEN	STOP LIGHT TO SPICE C
7	BLACK	TO LIGHT SWITCH TO SPICE F	29	GREEN	STOP LIGHT TO SPICE D
8	BLACK	TO LIGHT SWITCH TO SPICE G	30	GREEN	STOP LIGHT TO SPICE E
9	BLACK	TO LIGHT SWITCH TO SPICE H	31	GREEN	STOP LIGHT TO SPICE F
10	BLACK	TO LIGHT SWITCH TO SPICE I	32	GREEN	STOP LIGHT TO SPICE G
11	BLACK	TO LIGHT SWITCH TO SPICE J	33	GREEN	STOP LIGHT TO SPICE H
12	BLACK	TO LIGHT SWITCH TO SPICE K	34	GREEN	STOP LIGHT TO SPICE I
13	BLACK	TO LIGHT SWITCH TO SPICE L	35	GREEN	STOP LIGHT TO SPICE J
14	BLACK	TO LIGHT SWITCH TO SPICE M	36	GREEN	STOP LIGHT TO SPICE K
15	BLACK	TO LIGHT SWITCH TO SPICE N	37	GREEN	STOP LIGHT TO SPICE L
16	BLACK	TO LIGHT SWITCH TO SPICE O	38	GREEN	STOP LIGHT TO SPICE M
17	BLACK	TO LIGHT SWITCH TO SPICE P	39	GREEN	STOP LIGHT TO SPICE N
18	BLACK	TO LIGHT SWITCH TO SPICE Q	40	GREEN	STOP LIGHT TO SPICE O
19	BLACK	TO LIGHT SWITCH TO SPICE R	41	GREEN	STOP LIGHT TO SPICE P
20	BLACK	TO LIGHT SWITCH TO SPICE S	42	GREEN	STOP LIGHT TO SPICE Q
21	BLACK	TO LIGHT SWITCH TO SPICE T	43	GREEN	STOP LIGHT TO SPICE R
22	BLACK	TO LIGHT SWITCH TO SPICE U	44	GREEN	STOP LIGHT TO SPICE S
23	BLACK	TO LIGHT SWITCH TO SPICE V	45	GREEN	STOP LIGHT TO SPICE T
24	BLACK	TO LIGHT SWITCH TO SPICE W	46	GREEN	STOP LIGHT TO SPICE U
25	BLACK	TO LIGHT SWITCH TO SPICE X	47	GREEN	STOP LIGHT TO SPICE V
26	BLACK	TO LIGHT SWITCH TO SPICE Y	48	GREEN	STOP LIGHT TO SPICE W
27	BLACK	TO LIGHT SWITCH TO SPICE Z	49	GREEN	STOP LIGHT TO SPICE X
28	BLACK	TO LIGHT SWITCH TO SPICE AA	50	GREEN	STOP LIGHT TO SPICE Y
29	BLACK	TO LIGHT SWITCH TO SPICE AB	51	GREEN	STOP LIGHT TO SPICE Z
30	BLACK	TO LIGHT SWITCH TO SPICE AC	52	GREEN	STOP LIGHT TO SPICE AA
31	BLACK	TO LIGHT SWITCH TO SPICE AD	53	GREEN	STOP LIGHT TO SPICE AB
32	BLACK	TO LIGHT SWITCH TO SPICE AE	54	GREEN	STOP LIGHT TO SPICE AC
33	BLACK	TO LIGHT SWITCH TO SPICE AF	55	GREEN	STOP LIGHT TO SPICE AD
34	BLACK	TO LIGHT SWITCH TO SPICE AG	56	GREEN	STOP LIGHT TO SPICE AE
35	BLACK	TO LIGHT SWITCH TO SPICE AH	57	GREEN	STOP LIGHT TO SPICE AF
36	BLACK	TO LIGHT SWITCH TO SPICE AI	58	GREEN	STOP LIGHT TO SPICE AG
37	BLACK	TO LIGHT SWITCH TO SPICE AJ	59	GREEN	STOP LIGHT TO SPICE AH
38	BLACK	TO LIGHT SWITCH TO SPICE AK	60	GREEN	STOP LIGHT TO SPICE AI
39	BLACK	TO LIGHT SWITCH TO SPICE AL	61	GREEN	STOP LIGHT TO SPICE AJ
40	BLACK	TO LIGHT SWITCH TO SPICE AM	62	GREEN	STOP LIGHT TO SPICE AK
41	BLACK	TO LIGHT SWITCH TO SPICE AN	63	GREEN	STOP LIGHT TO SPICE AL
42	BLACK	TO LIGHT SWITCH TO SPICE AO	64	GREEN	STOP LIGHT TO SPICE AM
43	BLACK	TO LIGHT SWITCH TO SPICE AP	65	GREEN	STOP LIGHT TO SPICE AN
44	BLACK	TO LIGHT SWITCH TO SPICE AQ	66	GREEN	STOP LIGHT TO SPICE AO
45	BLACK	TO LIGHT SWITCH TO SPICE AR	67	GREEN	STOP LIGHT TO SPICE AP
46	BLACK	TO LIGHT SWITCH TO SPICE AS	68	GREEN	STOP LIGHT TO SPICE AQ
47	BLACK	TO LIGHT SWITCH TO SPICE AT	69	GREEN	STOP LIGHT TO SPICE AR
48	BLACK	TO LIGHT SWITCH TO SPICE AU	70	GREEN	STOP LIGHT TO SPICE AS
49	BLACK	TO LIGHT SWITCH TO SPICE AV	71	GREEN	STOP LIGHT TO SPICE AT
50	BLACK	TO LIGHT SWITCH TO SPICE AW	72	GREEN	STOP LIGHT TO SPICE AU
51	BLACK	TO LIGHT SWITCH TO SPICE AX	73	GREEN	STOP LIGHT TO SPICE AV
52	BLACK	TO LIGHT SWITCH TO SPICE AY	74	GREEN	STOP LIGHT TO SPICE AW
53	BLACK	TO LIGHT SWITCH TO SPICE AZ	75	GREEN	STOP LIGHT TO SPICE AX
54	BLACK	TO LIGHT SWITCH TO SPICE BA	76	GREEN	STOP LIGHT TO SPICE AY
55	BLACK	TO LIGHT SWITCH TO SPICE BB	77	GREEN	STOP LIGHT TO SPICE AZ
56	BLACK	TO LIGHT SWITCH TO SPICE BC	78	GREEN	STOP LIGHT TO SPICE BA
57	BLACK	TO LIGHT SWITCH TO SPICE BD	79	GREEN	STOP LIGHT TO SPICE BB
58	BLACK	TO LIGHT SWITCH TO SPICE BE	80	GREEN	STOP LIGHT TO SPICE BC
59	BLACK	TO LIGHT SWITCH TO SPICE BF	81	GREEN	STOP LIGHT TO SPICE BD
60	BLACK	TO LIGHT SWITCH TO SPICE BG	82	GREEN	STOP LIGHT TO SPICE BE
61	BLACK	TO LIGHT SWITCH TO SPICE BH	83	GREEN	STOP LIGHT TO SPICE BF
62	BLACK	TO LIGHT SWITCH TO SPICE BI	84	GREEN	STOP LIGHT TO SPICE BG
63	BLACK	TO LIGHT SWITCH TO SPICE BJ	85	GREEN	STOP LIGHT TO SPICE BH
64	BLACK	TO LIGHT SWITCH TO SPICE BK	86	GREEN	STOP LIGHT TO SPICE BI
65	BLACK	TO LIGHT SWITCH TO SPICE BL	87	GREEN	STOP LIGHT TO SPICE BJ
66	BLACK	TO LIGHT SWITCH TO SPICE BM	88	GREEN	STOP LIGHT TO SPICE BK
67	BLACK	TO LIGHT SWITCH TO SPICE BN	89	GREEN	STOP LIGHT TO SPICE BL
68	BLACK	TO LIGHT SWITCH TO SPICE BO	90	GREEN	STOP LIGHT TO SPICE BM
69	BLACK	TO LIGHT SWITCH TO SPICE BP	91	GREEN	STOP LIGHT TO SPICE BN
70	BLACK	TO LIGHT SWITCH TO SPICE BQ	92	GREEN	STOP LIGHT TO SPICE BO
71	BLACK	TO LIGHT SWITCH TO SPICE BR	93	GREEN	STOP LIGHT TO SPICE BP
72	BLACK	TO LIGHT SWITCH TO SPICE BS	94	GREEN	STOP LIGHT TO SPICE BQ
73	BLACK	TO LIGHT SWITCH TO SPICE BT	95	GREEN	STOP LIGHT TO SPICE BR
74	BLACK	TO LIGHT SWITCH TO SPICE BU	96	GREEN	STOP LIGHT TO SPICE BS
75	BLACK	TO LIGHT SWITCH TO SPICE BV	97	GREEN	STOP LIGHT TO SPICE BT
76	BLACK	TO LIGHT SWITCH TO SPICE BV	98	GREEN	STOP LIGHT TO SPICE BU
77	BLACK	TO LIGHT SWITCH TO SPICE BV	99	GREEN	STOP LIGHT TO SPICE BV
78	BLACK	TO LIGHT SWITCH TO SPICE BV	100	GREEN	STOP LIGHT TO SPICE BV

Models 1603-4-5, 1607-8

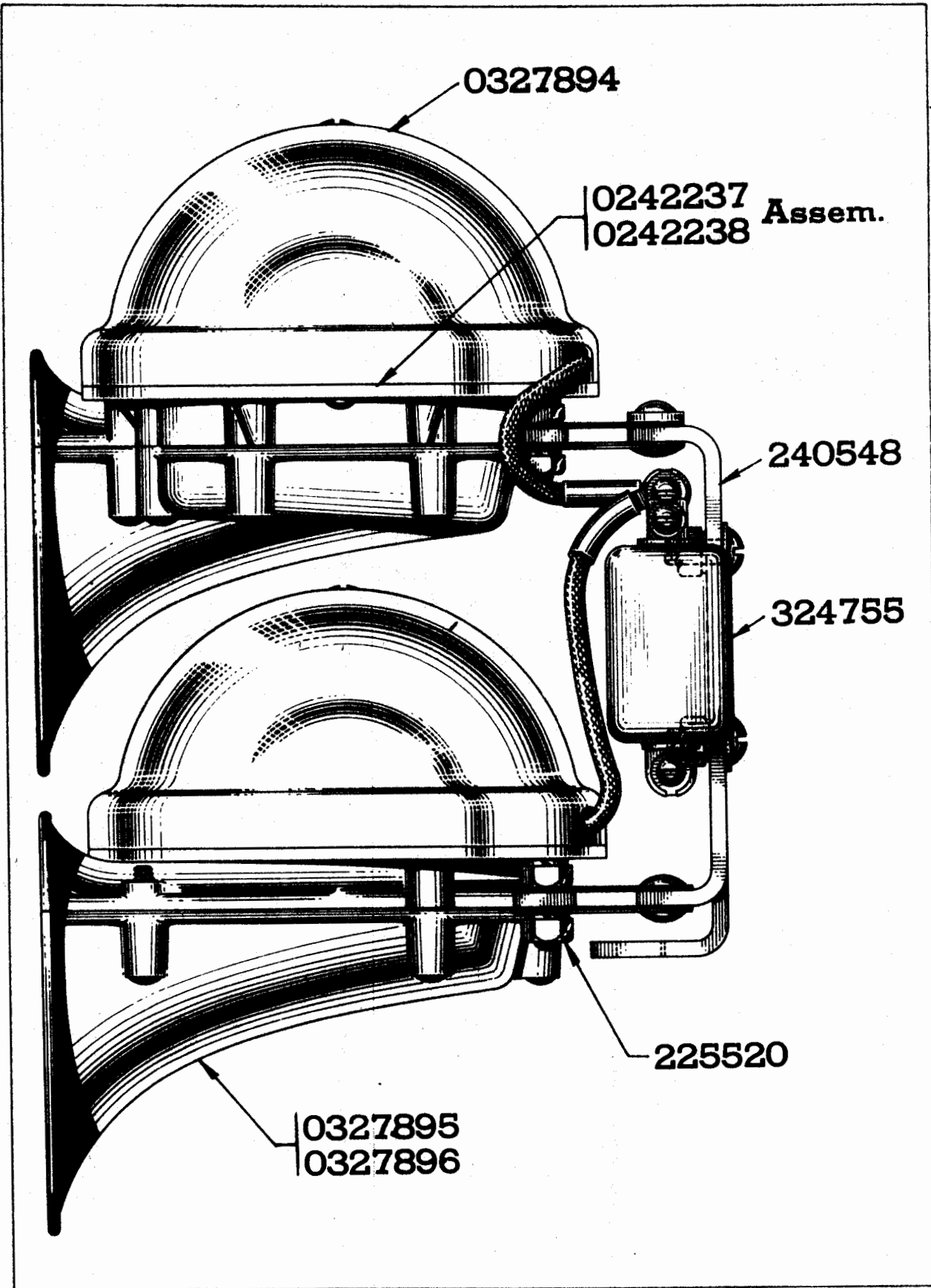

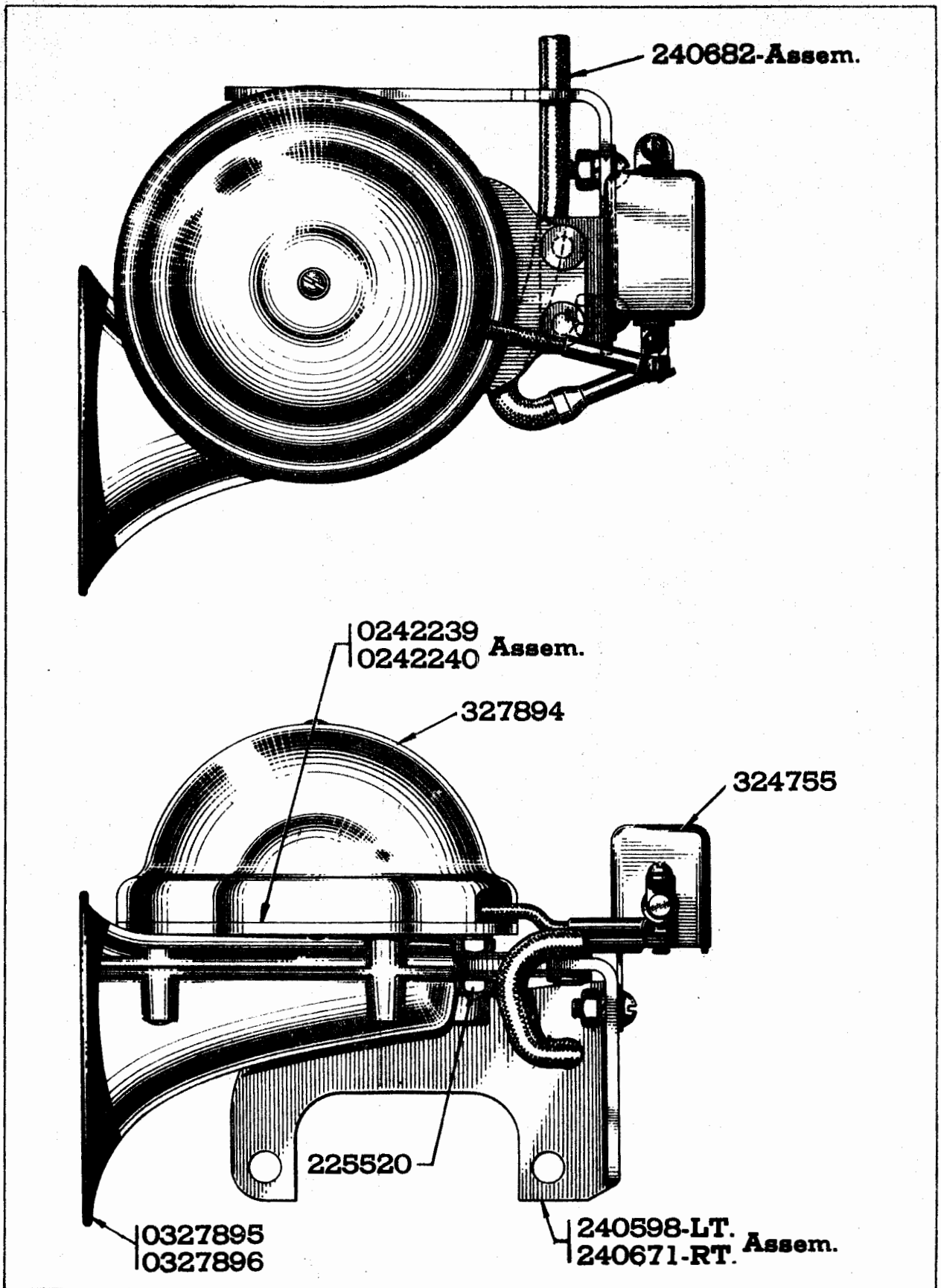

Piece No.	Name	1500	1506	1603	1607	1707	
		1501	1507	1604	1608	1708	
		1502	1508	1605	No. Required		
48202	Electrical-cable terminal 1/4 eye	1	1	-	-	-	
53127	Electrical-cable terminal-side 25/64 eye	1	1	1	1	1	
231297	Electrical-cable terminal-side 9/32 eye	1	1	1	1	1	
36111	Electrical-cable terminal insulator	41	42	32	35	35	
48616	Electrical-cable terminal insulator	2	2	2	2	2	
202926	Electrical-cable terminal insulator	13	13	-	-	-	
225467	Electrical-cable terminal insulator	3	3	-	-	-	
234721	Electrical-cable terminal insulator	-	-	1	1	1	
326815	Electrical-foot dimmer switch assembly (Supersedes 300107 and 303245)	1	1	1	1	1	
6373	Screw 1/4-20 x 3/8 rnd. hd.	2	2	2	2	2	
5502	Lockwasher 1/4 std.	2	2	2	2	2	
311729	Electrical-foot dimmer switch cap	1	1	1	1	1	
324621	Electrical-gasoline tank gauge terminal boot ..	1	1	1	1	1	
239536	Electrical-generator current and voltage regulator (6 volt) (Auto-Lite)	1	-	1	-	-	
239532	Electrical-generator current and voltage regulator (Auto-Lite)	-	1	-	1	1	
242058	Electrical-generator current and voltage regulator (12 volt)	-	-	1	-	-	
237135	Electrical-generator current and voltage regulator (Delco)	1	-	-	-	-	
237136	Electrical-generator current and voltage regulator (Delco)	-	1	-	-	-	
6567	Screw No. 10 x 5/8 binding hd. (Parker Kalon)	4	4	4	4	4	
239543	Electrical-generator current and voltage regulator ground strap (Auto-Lite)	1	1	-	-	-	
234855	Electrical-horn and mounting assembly	1	1	-	-	-	
234569	Electrical-horn assembly - long	1	1	-	-	-	
234570	Electrical-horn assembly - short	1	1	-	-	-	
240586	Electrical-horn assembly (low pitch) right (with 6 volt equipment)	-	-	1	-	-	
240679	Electrical-horn assembly (low pitch) right	-	-	-	1	1	
240585	Electrical-horn assembly (high) (with 6 volt equipment)	-	-	1	1	1	
242072	Electrical-horn assembly (low pitch) right (with 12 volt equipment)	-	-	1	-	-	
242073	Electrical-horn assembly (high) (with 12 volt equipment)	-	-	1	-	-	
225520	Electrical-horn assembly nut No. 12-24	-	-	4	4	4	
6685	Nut No. 12-32 plain	4	4	-	-	-	
4683	Lockwasher 7/32"	-	-	4	4	4	
6686	Lockwasher No. 12 (Everlock)	4	4	-	-	-	
240682	Electrical-horn assembly right to horn relay cable assembly	-	-	-	1	1	
240683	Electrical-horn assembly right to horn relay cable insulator	-	-	-	1	1	
71397	Electrical-horn assembly right to horn relay cable terminal (spade)	-	-	-	1	1	
36111	Electrical-horn assembly right to horn relay cable terminal insulator	-	-	-	2	2	

SERVICE PARTS LIST--PACKARD SUPER-EIGHT AND TWELVE

Electrical 35

Piece No.	Name	1500	1506	1603	1607	1707
		1501	1507	1604	1608	1708
		1502	1508	1605	No. Required	
0327899	Electrical-horn armature adjusting nut (with 6 volt equipment)	-	-	2	2	2
240548	Electrical-horn bracket assembly	-	-	1	-	-
240598	Electrical-horn bracket assembly - left	-	-	-	1	1
240671	Electrical-horn bracket assembly - right	-	-	-	1	1
234573	Electrical-horn bracket assembly	1	1	-	-	-
6704	Electrical-horn bracket to dash screw 1/4-28 x 1-1/4 hex. hd. header point	4	-	-	-	-
6705	Screw 1/4-28 x 1-1/4 hex. hd. header point	-	4	-	-	-
5502	Lockwasher 1/4	4	4	-	-	-
6703	Plain washer 1/4 special	4	4	-	-	-
232856	Electrical-horn bracket to dash screw insulator	8	8	-	-	-
232850	Electrical-horn bracket to dash screw insulator sleeve	4	4	-	-	-
240551	Electrical-horn bracket to cylinder head spacer	-	-	2	-	-
0242582	Electrical-horn diaphragm - low pitch (with 6 volt equipment)	-	-	1	1	1
0242583	Electrical-horn diaphragm - high pitch (with 6 volt equipment)	-	-	1	1	1
0327897	Electrical-horn diaphragm gasket (with 6 volt equipment)	-	-	2	2	2
0242348	Electrical horn elbow	2	2	-	-	-
234637	Electrical-horn ground strap	1	1	-	-	-
0242237	Electrical-horn motor assembly (low pitch) (with 6 volt equipment)	-	-	1	-	-
0242238	Electrical-horn motor assembly (high pitch) (with 6 volt equipment)	-	-	1	-	-
0242239	Electrical-horn motor assembly (low pitch) (with 6 volt equipment)	-	-	-	1	1
0242240	Electrical-horn motor assembly (high pitch) (with 6 volt equipment)	-	-	-	1	1
0327894	Electrical-horn motor cover (with 6 volt equipment)	-	-	2	2	2
303751	Electrical-horn mounting plate spacer	4	4	4	4	4
0327895	Electrical-horn projector and front housing (bell) low pitch (with 6 volt equipment)	-	-	1	1	1
0327896	Electrical-horn projector and front housing (bell) high pitch (with 6 volt equipment) ...	-	-	1	1	1
324755	Electrical-horn relay (with 6 volt equipment) .	-	-	1	1	1
327572	Electrical-horn relay (with 12 volt equipment).	-	-	1	-	-
302854	Electrical-horn relay	1	1	-	-	-
239105	Screw	2	2	-	-	-
6584	Screw 1/4-28 x 5/8 rnd. hd.	-	-	2	2	2
5502	Lockwasher 1/4	2	2	2	2	2
7004	Nut 1/4-28	-	-	-	2	2
0327898	Electrical-horn resistor assembly	-	-	1	1	1
232739	Electrical-instrument board signal light sockets and cables assembly	1	1	-	-	-
225262	Electrical-instrument board signal light cable tip	4	4	-	-	-
225261	Electrical-instrument board signal light socket	4	4	-	-	-
225263	Electrical-instrument board signal light spring	4	4	-	-	-

Piece No.	Name	1500	1506	1603	1607	1707
		1501	1507	1604	1608	1708
		1502	1508	1605	No. Required	
225264	Electrical-instrument board signal light spring washer	4	4	-	-	-
237656	Electrical-lamp front cable loom	1	1	-	-	-
302121	Electrical-lamp rear fuse	1	1	1	1	1
225262	Electrical-lamp rear fuse cable tip	2	2	2	2	2
311797	Electrical-lamp rear fuse container and cable assembly	1	1	1	1	1
228882	Electrical-lamp rear fuse container	1	1	1	1	1
228887	Electrical-lamp rear fuse container cup	1	1	1	1	1
225263	Electrical-lamp rear fuse container spring	1	1	1	1	1
225264	Electrical-lamp rear fuse container washer	1	1	1	1	1
228886	Electrical-lamp rear fuse insulator	1	1	1	1	1
197983	Electrical-motor to frame ground cable assembly	1	1	1	1	1
3877	Washer 3/8 "N" std.	2	2	2	2	2
302121	Electrical-stoplight fuse (20 amp.)	1	1	1	1	1
228882	Electrical-stoplight fuse container	1	1	1	1	1
228887	Electrical-stoplight fuse container cap	1	1	1	1	1
225262	Electrical-stoplight fuse container cable tip .	2	2	2	2	2
228886	Electrical-stoplight fuse container insulating tube	1	1	1	1	1
225263	Electrical-stoplight fuse container spring	1	1	1	1	1
225264	Electrical-stoplight fuse container washer	1	1	1	1	1
320980	Electrical-stoplight switch (Supersedes 304012)	1	1	1	1	1
237200	Electrical-wiring assembly - main (L.H. drive).	1	-	-	-	-
237206	Electrical-wiring assembly - main	-	1	-	-	-
240634	Electrical-wiring assembly - main (L.H. drive).	-	-	1	-	-
240633	Electrical-wiring assembly - main	-	-	-	1	1
234890	Electrical-wiring assembly - main (R.H. drive).	1	-	-	-	-
240709	Electrical-wiring assembly - main (R.H. drive).	-	-	1	-	-
237250	Electrical-wiring assembly - rear (Used on 1500) (R.H. drive)	1	-	-	-	-
237251	Electrical-wiring assembly - rear (Used on 1501) (R.H. drive)	1	-	-	-	-
237252	Electrical-wiring assembly - rear (Used on 1502) (R.H. drive)	1	-	-	-	-
240636	Electrical-wiring assembly - rear (Used on 1603-1606)	-	-	1	1	1
240637	Electrical-wiring assembly - rear (Used on 1604-1607-1707)	-	-	1	1	1
237390	Electrical-wiring assembly - rear (Used on 1500-1506) (L.H. drive)	1	1	-	-	-
237391	Electrical-wiring assembly - rear (Used on 1501-1507) (L.H. drive)	1	1	-	-	-
240638	Electrical-wiring assembly - rear (Used on 1605-1608-1708)	-	-	1	1	1
237392	Electrical-wiring assembly - rear (Used on 1502-1508) (L.H. drive)	1	1	-	-	-
304193	Electrical-wiring assembly (at rear intermediate channel) insulator	1	1	1	1	1
225918	Electrical-wiring assembly toe board grommet - left	1	1	-	-	-

SERVICE PARTS LIST--PACKARD SUPER-EIGHT AND TWELVE

Electrical 37

Piece No.	Name	1500	1506	1603	1607	1707	
		1501	1507	1604	1608	1708	
		1502	1508	1605	No. Required		
225919	Electrical-wiring assembly toe board grommet - right	-	1	-	1	1	
225746	Electrical-wiring assembly (at X member) insulator	1	1	1	1	1	
237516	Electrical-wiring assembly (at rear channel) insulator	1	1	1	1	1	
237954	Electrical-wiring (at battery) insulator	1	1	1	1	1	
144926	Electrical-wiring battery to starter switch cables retaining ring	1	-	-	-	-	
203905	Electrical-wiring cable to brake tube strap clamp	2	2	2	2	2	
232726	Electrical-wiring cables to frame (at clutch pedal) clip	1	-	-	-	-	
234645	Electrical-wiring cables to frame (at clutch pedal) clip	-	1	-	-	-	
231138	Electrical-wiring cables to frame (at clutch pedal) insulator	1	1	-	-	-	
201570	Electrical-wiring clip-to dash lower	-	-	2	2	2	
194151	Electrical-wiring clip-to dash upper (Supersedes 311740)	-	-	1	1	1	
304078	Electrical-wiring clip-to dash lower--screw 3/8-16 x 1/2 hex. hd.	-	-	1	1	1	
304308	Electrical-wiring clip-to dash upper--screw No. 10 (Parker Kalon)	-	-	1	1	1	
209851	Electrical-wiring clip-for headlight cable at radiator core cradle	-	-	4	4	4	
194019	Electrical-wiring dash grommet	-	-	1	1	1	
232880	Electrical-wiring dimmer switch cable to dash clip (R.H. drive)	3	-	3	-	-	
232925	Electrical-wiring domelight cable frame insulator--left	1	1	1	1	1	
237565	Electrical-wiring domelight cable frame insulator--right	1	1	1	1	1	
170401	Electrical-wiring domelight cable frame grommet	1	1	1	1	1	
231157	Electrical-wiring to frame side rear left clip--boltless	1	1	1	1	1	
225678	Electrical-wiring frame front shear plate insulator	1	1	-	-	-	
232796	Electrical-wiring to frame side rear right clip--boltless	1	1	1	1	1	
302121	Electrical-wiring fuse (auxiliary)	1	1	-	-	-	
232608	Electrical-wiring gas gauge and stoplight fuse cable assembly	1	1	-	-	-	
240662	Electrical-wiring gas gauge and stoplight fuse cable assembly	-	-	1	1	1	
240604	Electrical-wiring harness assembly dash cover and felt assembly	-	-	1	1	1	
5984	Screw No. 6 x 3/8 rnd. hd. (Parker Kalon)	-	-	3	3	3	
240605	Electrical-wiring harness assembly dash cover felt	-	-	1	1	1	
316556	Electrical-wiring headlamp indicator light socket	-	-	3	3	3	

Piece No.	Name	1500	1506	1603	1607	1707
		1501	1507	1604	1608	1708
		1502	1508	1605	No. Required	
68073	Electrical-wiring horn button cable to dash clip (R.H. drive)	1	-	1	-	-
5447	Lockwasher 1/4 (Shakeproof) (R.H. drive) .	4	-	4	-	-
7004	Nut 1/4 plain (R.H. drive)	4	-	4	-	-
197877	Electrical-wiring horn button cable to frame clip (R.H. drive)	2	-	2	-	-
237490	Electrical-wiring horn button cable insulator (R.H. drive)	1	-	1	-	-
234925	Electrical-wiring insulator-for headlight cables (Supesedes 231139)	-	-	2	2	2
234721	Electrical-wiring insulator-for toe board right	-	-	-	1	1
209611	Electrical-wiring lamp front cables to front channel-clip - boltless	3	3	-	-	-
201480	Electrical-wiring lamp front cables to fender bracket clip	2	2	-	-	-
209611	Electrical-wiring lamp front cables to fender bracket clip	-	-	2	2	2
7710	Bolt No. 10-32 x 5/8 fill. hd.	2	2	-	-	-
7003	Nut No. 10-32 plain	2	2	-	-	-
5500	Lockwasher 3/16	2	2	-	-	-
239169	Electrical-wiring lamp rear insulator to body grommet (Use with bodies 1003-12-13-14-15-16-23-32-33-34-35-36-63-73-L394-L395-1103-12-13-14-15-16-32-33-34-35-36-43-53-1232-33-34-35-36-53)	2	2	2	2	2
231157	Electrical-wiring rear channel cable clip - boltless	3	3	3	3	3
197877	Electrical-wiring to front fender shield clip .	3	3	4	4	4
209611	Electrical-wiring to sub-channel rear right clip - boltless	3	3	3	3	3
207079	Electrical-wiring to sub-channel rear left clip - boltless	2	2	2	2	2
209851	Electrical-wiring stoplight switch cable clip (R.H. drive)	1	-	-	-	-
5198	Screw No. 10-32 x 5/8 hex. hd. (R.H. drive)	1	-	-	-	-
7003	Nut No. 10-32 plain (R.H. drive)	1	-	-	-	-
5500	Lockwasher No. 10 R.H. drive)	1	-	-	-	-
225083	Electrical-wiring toe board insulator	1	-	-	-	-
234721	Electrical-wiring toe board insulator--right ..	-	1	-	-	-
225083	Electrical-wiring toe board insulator--left ...	-	1	-	-	-
67277	Electrical-wiring voltage regulator cables to dash panel clip	1	1	-	-	-

EXHAUST

232210	Exhaust muffler (front) assembly	1	-	1	-	-
190729	Exhaust muffler (front) clamp--front	1	-	1	-	-
221484	Exhaust muffler (front) clamp	-	1	-	1	1
7820	Screw 3/8-24 x 1-3/8 hex. hd.	1	-	1	-	-
7869	Screw 3/8-24 x 1-7/8 hex. hd.	-	2	-	2	2
6048	Lockwasher 3/8	1	2	1	2	2

SERVICE PARTS LIST--PACKARD SUPER-EIGHT AND TWELVE

Exhaust 39

Piece No.	Name	1500	1506	1603	1607	1707	
		1501	1507	1604	1608	1708	
		1502	1508	1605	No. Required		
7006	Nut 3/8-24	1	2	1	2	2	
302714	Washer--Special	2	-	2	-	-	
237469	Exhaust muffler (front) support	1	-	1	-	-	
237461	Exhaust muffler (front) support	-	1	-	1	1	
7820	Screw 3/8-24 x 1-3/8 hex. hd.	1	1	1	1	1	
6048	Lockwasher 3/8	1	1	1	1	1	
7006	Nut 3/8-24	1	1	1	1	1	
302714	Washer--Special	2	-	1	1	1	
309862	Exhaust muffler (front) support bracket assy. .	-	1	-	1	1	
5449	Exhaust muffler (front) support bracket to frame bolt 5/16-24 x 3/4 hex. hd.	-	2	-	2	2	
6044	Lockwasher 5/16	-	2	-	2	2	
7005	Nut 5/16-24 plain	-	2	-	2	2	
5891	Exhaust muffler (front) support to insulator screw 3/8-24 x 1 hex. hd.	2	-	2	-	-	
8222	Screw 3/8-24 x 1 flat hd.	-	1	-	1	1	
6048	Lockwasher 3/8	2	1	2	1	1	
7006	Nut 3/8-24	2	1	2	1	1	
5049	Washer 3/8--Special	2	1	2	1	1	
237449	Exhaust muffler (front) and heat deflector assembly	-	1	-	1	1	
232220	Exhaust muffler (rear) and outlet tube front assembly (1500-1603)	1	-	1	-	-	
232221	Exhaust muffler (rear) and outlet tube front assembly (1501-1604)	1	-	1	-	-	
237466	Exhaust muffler (rear) and outlet tube front assembly (1506)	-	1	-	-	-	
237467	Exhaust muffler (rear) and outlet tube front assembly (1507-1607-1707)	-	1	-	1	1	
242254	Exhaust muffler (rear) and outlet tube front assembly (1603A Hearse)	-	-	1	-	-	
232222	Exhaust muffler (rear) and outlet tube front assembly (1502-1605)	1	-	1	-	-	
237468	Exhaust muffler (rear) and outlet tube front assembly (1508-1608-1708)	-	1	-	1	1	
232358	Exhaust muffler (rear) clamp	1	-	1	-	-	
232829	Exhaust muffler (rear) clamp	-	1	-	1	1	
7820	Screw 3/8-24 x 1-3/8 hex. hd.	1	1	1	1	1	
7006	Nut 3/8-24	1	1	1	1	1	
6048	Lockwasher 3/8	1	1	1	1	1	
302714	Washer--Special	1	1	2	2	2	
237480	Exhaust muffler (rear) support bracket assembly	-	1	-	1	1	
232850	Exhaust muffler (rear) support bracket-bolt sleeve	-	3	-	3	3	
6044	Lockwasher 5/16 (Shakeproof)	-	3	-	3	3	
7005	Nut 5/16-24	-	3	-	3	3	
7828	Exhaust muffler (rear) support bracket to frame screw 5/16-24 x 1-1/8 hex. hd.	-	3	-	3	3	
201811	Washer plain--Special	-	3	-	3	3	
232856	Exhaust muffler (rear) support bracket to frame insulator	-	6	-	6	6	

40 Exhaust

SERVICE PARTS LIST--PACKARD SUPER-EIGHT AND TWELVE

Piece No.	Name	1500	1506	1603	1607	1707	
		1501	1507	1604	1608	1708	
		1502	1508	1605	No. Required		
237488	Exhaust muffler (rear) support bracket strap--upper	-	1	-	1	1	
237487	Exhaust muffler (rear) support bracket strap--lower	-	1	-	1	1	
7853	Screw 3/8-24 x 1-1/8 hex. hd.	-	1	-	1	1	
6048	Lockwasher 3/8	-	1	-	1	1	
7006	Nut 3/8-24	-	1	-	1	1	
300436	Exhaust muffler support insulator	2	-	2	-	-	
237533	Exhaust muffler support insulator	-	2	-	2	2	
7861	Exhaust muffler support insulator to frame bracket screw 5/16-24 x 1 hex. hd.	4	2	4	2	2	
6044	Lockwasher 5/16	4	2	4	2	2	
7005	Nut 5/16-24	2	-	2	-	-	
3909	Washer 5/16--Special	4	2	4	2	2	
232223	Exhaust outlet tube (rear)(Use on body 1003-1103)	1	-	1	-	-	
232688	Exhaust outlet tube (rear)(Use on bodies 1007-16-17-18-19-1107-16-17-18-19)	1	-	1	-	-	
232754	Exhaust outlet tube (rear)(Use on bodies 1012-13-14-15-1063-L394-L395-1112-13-14-15-43) ...	1	-	1	-	-	
234536	Exhaust outlet tube (rear) bracket--rear	1	-	1	-	-	
234537	Exhaust outlet tube (rear) bracket--rear	-	1	-	1	-	
7820	Screw 3/8-24 x 1-3/8 hex. hd.	1	1	1	1	1	
7006	Nut 3/8-24	1	1	1	1	1	
6048	Lockwasher 3/8	1	1	1	1	1	
302714	Washer--Special	1	1	1	1	1	
232856	Exhaust outlet tube (rear) bracket (rear) to insulator	4	4	4	4	4	
232850	Exhaust outlet tube (rear) bracket (rear) to frame spacer	2	2	2	2	2	
7828	Exhaust outlet tube (rear) bracket (rear) to frame screw 5/16-24 x 1-1/8 hex. hd.	2	2	2	2	2	
201811	Washer plain (special)	2	2	2	2	2	
6044	Lockwasher 5/16	2	2	2	2	2	
7005	Nut 5/16-24	2	2	2	2	2	
237456	Exhaust outlet tube (rear) and bracket support connection assembly (Use with body 1003-1103)	1	-	1	-	-	
237458	Exhaust outlet tube (rear) and bracket support connection assembly (Use with bodies 1012-13-14-15-1063-L394-L395-1112-13-14-15-43)	1	-	1	-	-	
237457	Exhaust outlet tube (rear) and bracket support connection assembly (Use with bodies 1007-1016-17-18-19-1107-1116-17-18-19)	1	-	1	-	-	
237561	Exhaust outlet tube (rear) and heat deflector assembly (Use with bodies 1023-32-33-34-35-1073-L394-L395-1132-33-34-35-1153-1232-33-34-35-53)	-	1	-	1	1	
237560	Exhaust outlet tube (rear) and heat deflector assembly (Use with bodies 1027-1036-37-38-39-1127-1136-37-38-39-1227-36-37-38-39)	1	1	-	1	1	
232308	Exhaust pipe bracket assembly	1	-	1	-	-	

SERVICE PARTS LIST--PACKARD SUPER-EIGHT AND TWELVE

Fenders 41

Piece No.	Name	1500	1506	1603	1607	1707
		1501	1507	1604	1608	1708
		1502	1508	1605	No. Required	
237839	Exhaust pipe bracket	1	1	-	1	1
190729	Exhaust pipe bracket clamp	1	-	1	-	-
237838	Exhaust pipe bracket clamp	-	1	-	1	1
7853	Screw 3/8-24 x 1-1/8 hex. hd.	1	-	-	-	-
7820	Screw 3/8-24 x 1-3/8 hex. hd.	-	-	1	-	-
6048	Lockwasher 3/8	1	-	1	-	-
6044	Lockwasher 5/16 (Shakeproof)	-	2	-	2	2
7006	Nut 3/8-24	1	-	1	-	-
7005	Nut 5/16-24	-	2	-	2	2
302714	Washer-plain	2	-	2	-	-
232359	Exhaust pipe and cover assembly (L.H. drive) ..	1	-	-	-	-
237444	Exhaust pipe and cover assembly	-	1	-	-	-
240518	Exhaust pipe and cover assembly (L.H. drive) ..	-	-	1	-	-
240349	Exhaust pipe and cover assembly	-	-	-	1	1
237311	Exhaust pipe and cover assembly (R.H. drive) ..	1	-	-	-	-
240519	Exhaust pipe and cover assembly (R.H. drive) ..	-	-	1	-	-
223180	Exhaust pipe cover (L.H. drive)	1	-	1	-	-
237312	Exhaust pipe cover (R.H. drive)	1	-	1	-	-
141532	Exhaust pipe cover clamp 3/4	2	-	2	-	-
141533	Exhaust pipe cover clamp 1-1/2	1	-	1	-	-
132585	Exhaust pipe flange--gasket	1	-	1	-	-
201167	Exhaust pipe flange--front gasket	-	1	-	1	1
6709	Exhaust pipe to motor manifold screw 3/8-24 x 1-9/16 hex. hd. special	4	-	4	-	-
242106	Exhaust pipe to motor manifold screw 3/8-24 x 1-7/8 hex. hd.	-	-	-	4	4
6295	Screw 3/8-24 x 1-7/8 hex. hd.	-	4	-	-	-
6708	Nut 3/8-24 plain	4	-	4	4	4
3877	Washer 3/8 "N" std.	-	4	-	4	4
6048	Lockwasher 3/8	-	4	-	4	4

FENDERS

(Specify color on all orders for fenders.)

231373	Front fender left assembly (Specify color) (Without well)	1	-	-	-	-
231375	Front fender left assembly (Specify color) (Without well)	-	1	-	-	-
231372	Front fender right assembly (Specify color) (Without well)	1	-	-	-	-
231374	Front fender right assembly (Specify color) (Without well)	-	1	-	-	-
234956	Front fender right assembly (Specify color) (With well)	1	-	-	-	-
234958	Front fender right assembly (Specify color) (With well)	-	1	-	-	-
234955	Front fender left assembly (Specify color) (With well)	1	-	-	-	-
234957	Front fender left assembly (Specify color) (With well)	-	1	-	-	-

42 Fenders

SERVICE PARTS LIST--PACKARD SUPER-EIGHT AND TWELVE

Piece No.	Name	1500	1506	1603-	1607	1707	
		1501	1507	1604	1608	1708	
		1502	1508	1605	No. Required		
225955	Front fender to body stud 1/4--special	2	2	-	-	-	
5502	Lockwasher 1/4	2	2	-	-	-	
7004	Nut 1/4-28	2	2	-	-	-	
62065	Washer 1/4--special	2	2	-	-	-	
232193	Front fender bracket assembly--left (Specify color)	1	1	-	-	-	
232194	Front fender bracket assembly--right (Specify color)	1	1	-	-	-	
7608	Front fender bracket bolt 5/16-24 x 3/4 carriage	4	4	-	-	-	
7005	Nut 5/16-24	4	4	-	-	-	
3909	Washer 5/16--Special	4	4	-	-	-	
5504	Lockwasher 5/16	4	4	-	-	-	
232197	Front fender bracket to fender clamping plate liner	2	2	-	-	-	
7951	Front fender bracket retaining screw 7/16-20 x 1-1/4 hex. hd.	8	8	-	-	-	
5508	Lockwasher 7/16	8	8	-	-	-	
225259	Front fender to frame brace rod	2	2	-	-	-	
225160	Front fender to frame brace rod insulator	4	4	-	-	-	
5133	Washer 1/2 plain--special	4	4	-	-	-	
6047	Lockwasher 1/2 (Shakeproof)	4	4	-	-	-	
6189	Nut 1/2-20	8	8	-	-	-	
3884	Washer 1/2 plain	4	4	-	-	-	
230176	Front fender left to fender right--liner	1	1	-	-	-	
7852	Screw 1/4-28 x 7/8 hex. hd.	2	2	-	-	-	
5502	Lockwasher 1/4	2	2	-	-	-	
7004	Nut 1/4-28	2	2	-	-	-	
7852	Front fender to radiator shell screw 1/4-28 x 7/8 hex. hd.	12	12	-	-	-	
7827	Screw 1/4-28 x 3/4 hex. hd.	2	2	-	-	-	
62065	Washer plain 1/4--special	18	18	-	-	-	
5502	Lockwasher 1/4	12	12	-	-	-	
7004	Nut 1/4-28	6	6	-	-	-	
7608	Front fender to running board bolt 5/16-24 x 3/4 carriage	10	10	-	-	-	
7005	Nut 5/16-24	10	10	-	-	-	
5504	Lockwasher 5/16	10	10	-	-	-	
223907	Front fender to running board liner	2	-	-	-	-	
223908	Front fender to running board liner	-	2	-	-	-	
231406	Front fender shield--left (Specify color)	-	1	-	-	-	
231404	Front fender shield--left (Specify color)	1	-	-	-	-	
231405	Front fender shield--right (Specify color)	-	1	-	-	-	
231403	Front fender shield--right (Specify color)	1	-	-	-	-	
234707	Front fender shield to dash seal	2	2	-	-	-	
101200	Front fender shield to dash seal screw washer ..	4	4	-	-	-	
7710	Screw No. 10-32 x 5/8 fill. hd. machine ..	4	4	-	-	-	
6103	Nut No. 10	4	4	-	-	-	
234704	Front fender shield to shock absorber baffle ..	-	2	-	-	-	
234857	Front fender shield to shock absorber spacer ..	-	2	-	-	-	
234705	Front fender shield skirt--front	2	-	-	-	-	
234706	Front fender shield skirt--front	-	2	-	-	-	

SERVICE PARTS LIST--PACKARD SUPER-EIGHT AND TWELVE

Fenders 43

Piece No.	Name	1500	1506	1603	1607	1707
		1501	1507	1604	1608	1708
		1502	1508	1605	No. Required	
234981	Front fender shield skirt front retainer front--right	-	1	-	-	-
234980	Front fender shield skirt front retainer rear--right	-	1	-	-	-
234708	Front fender shield skirt front retainer--left.	-	1	-	-	-
234903	Front fender shield skirt front retainer--left.	1	-	-	-	-
234902	Front fender shield skirt front retainer--right	1	-	-	-	-
194607	Front fender shield skirt front rivet 9/64 x 7/16 oval hd. tubular	10	-	-	-	-
234709	Front fender shield skirt--rear	2	-	-	-	-
234710	Front fender shield skirt--rear	-	2	-	-	-
234713	Front fender shield skirt--rear to frame retainer left	-	1	-	-	-
234714	Front fender shield skirt--rear to frame retainer right	-	1	-	-	-
234711	Front fender shield skirt--rear to frame retainer left	1	-	-	-	-
234712	Front fender shield skirt--rear to frame retainer right	1	-	-	-	-
303939	Screw 5/16-18 x 1/2 hex. hd. (Washer type)	14	12	-	-	-
232549	Front fender shield skirt rear retainer	2	-	-	-	-
232548	Front fender shield skirt rear retainer	-	2	-	-	-
5995	Front fender shield skirt rivet 9/64 x 1/4 oval hd. tubular	24	12	-	-	-
139521	Front fender shield skirt rivet 5/32 x 7/16 oval head split	24	20	-	-	-
140855	Front fender shield skirt rivet 5/32 x 9/16 oval head split	-	4	-	-	-
234900	Front fender wheel well wheel cushion	4	-	-	-	-
234974	Front fender wheel well wheel cushion	-	4	-	-	-
304001	Front fender wheel well wheel cushion fastener.	16	16	-	-	-
231625	Rear fender--left assembly (Specify color) (Used on bodies 1003-12-13-14-15-16-63-L394-L-395)	1	-	-	-	-
231549	Rear fender--felt assembly (Specify color) (Used on bodies 1007-17-18-19)	1	-	-	-	-
231627	Rear fender--left assembly (Specify color) (Used on bodies 1023-32-33-34-35-36-73-L394-L395)	-	1	-	-	-
231550	Rear fender--left assembly (Specify color) (Used on bodies 1027-37-38-39)	-	1	-	-	-
231626	Rear fender--right assembly (Specify color) (Used on bodies (1023-32-33-34-35-36-73-L394-L395)	-	1	-	-	-
224654	Rear fender--right assembly (Specify color) (Used on bodies 1027-37-38-39)	-	1	-	-	-
226008	Rear fender--right assembly (Specify color) (Used on bodies 1007-17-18-19)	1	-	-	-	-
231624	Rear fender--right assembly (Specify color) (Used on bodies 1003-12-13-14-15-16-63-L394-L395)	1	-	-	-	-

Piece No.	Name	1500	1506	1603	1607	1707
		1501	1507	1604	1608	1708
		1502	1508	1605	No. Required	
224885	Rear fender to body liner (Used on bodies 1003-12-13-14-15-16-23-32-33-34-35-36-63-73-L394-L395)	2	2	-	-	-
224886	Rear fender to body liner (Used on bodies 1007-1027-1017-1037-1018-1038-1019-1039)	1	1	-	-	-
7809	Rear fender to body screw 5/16-24 x 7/8 hex. hd.	x	x	-	-	-
5449	Screw 5/16-24 x 3/4 hex. hd.	6	6	-	-	-
7861	Screw 5/16-24 x 1 hex. hd.	x	x	-	-	-
7812	Screw 5/16-24 x 1-3/4 hex. hd.	2	2	-	-	-
5504	Lockwasher 5/16	26	26	-	-	-
3909	Washer 5/16 plain special	x	x	-	-	-
162389	Rear fender to body screw washer	x	x	-	-	-
6427	Rear fender to body stud 5/16-24	2	2	-	-	-
7005	Nut 5/16-24	x	x	-	-	-
226771	Rear fender pebble guard assembly (left) (Specify color)	1	1	-	-	-
226772	Rear fender pebble guard assembly (right) (Specify color)	1	1	-	-	-
7827	Screw 1/4-28 x 3/4 hex. hd.	4	4	-	-	-
303939	Screw 5/16-18 x 1/2 hex. hd. washer type .	4	4	-	-	-
3870	Washer 1/4 plain special	6	6	-	-	-
5502	Lockwasher 1/4	4	4	-	-	-
7004	Nut 1/4-28	4	4	-	-	-
7600	Rear fender to running board bolt 5/16-24 x 7/8 carriage	6	6	-	-	-
5449	Screw 5/16-24 x 3/4 hex. hd.	2	2	-	-	-
5504	Lockwasher 5/16	8	8	-	-	-
7005	Nut 5/16-24	8	8	-	-	-
3909	Washer 5/16 plain special	4	4	-	-	-

FENDERS

(Specify color on all orders for Painted Fender Parts)

240000	Front fender left assembly (Specify color) (Without well)	-	-	1	1	1
240001	Front fender right assembly (Specify color) (Without well)	-	-	1	1	1
240571	Front fender right assembly (Specify color) (With well)	-	-	1	1	1
240570	Front fender left assembly (Specify color) (With well)	-	-	1	1	1
240291	Front fender assembly to body liner	-	-	2	2	2
307082	Front fender assembly to body liner clip	-	-	2	2	2
232363	Front fender assembly to body screw--5/16-18 x 7/8 hex. hd.	-	-	-	-	2
325724	Front fender assembly to body screw 5/16-10 special	-	-	6	6	6
7861	Front fender assembly to body screw 5/16-24 x 1 hex. hd.	-	-	6	6	-

SERVICE PARTS LIST--PACKARD SUPER-EIGHT AND TWELVE

Fenders 45

Piece No.	Name	1500	1506	1603	1607	1707	
		1501	1507	1604	1608	1708	
		1502	1508	1605	No. Required		
3909	Washer 5/16 special	-	-	6	6	6	
5504	Lockwasher 5/16	-	-	6	6	6	
240707	Front fender to bonnet side bumper--center	-	-	2	2	2	
7608	Front fender assembly to fender bracket bolt 5/16-24 x 3/4 carriage	-	-	4	4	4	
7005	Nut 5/16-24	-	-	4	4	4	
5504	Lockwasher 5/16	-	-	4	4	4	
3909	Washer 5/16 plain	-	-	4	4	4	
225259	Front fender assembly to frame brace rod	-	-	2	2	2	
225160	Front fender assembly to frame brace rod insulator	-	-	4	4	4	
6189	Nut 1/2-20	-	-	8	8	8	
6047	Lockwasher 1/2 (Shakeproof)	-	-	4	4	4	
3884	Washer 1/2 std.	-	-	4	4	4	
5133	Washer 1/2 special	-	-	4	4	4	
240243	Front fender assembly to radiator shell finish moulding	-	-	2	2	2	
240244	Front fender assembly to radiator shell liner-- lower	-	-	2	2	2	
240249	Front fender assembly to radiator shell liner-- upper	-	-	2	2	2	
7852	Front fender assembly to radiator shell screw 1/4-28 x 7/8 hex. hd.	-	-	10	10	10	
7004	Nut 1/4-28	-	-	10	10	10	
5502	Lockwasher 1/4	-	-	10	10	10	
62065	Washer 1/4 plain	-	-	20	20	20	
7608	Front fender assembly to running board bolt 5/16-24 x 3/4 carriage	-	-	10	10	10	
7005	Nut 5/16-24	-	-	10	10	10	
5504	Lockwasher 5/16	-	-	10	10	10	
240240	Front fender assembly to running board liner ..	-	-	2	2	2	
240004	Front fender bracket assembly--left	-	-	1	1	1	
240005	Front fender bracket assembly--right	-	-	1	1	1	
242433	Front fender bracket assembly to fender shim ..	-	-	4	4	4	
242003	Front fender bracket assembly to front splash stud	-	-	2	2	2	
7005	Nut 5/16-24	-	-	2	2	2	
3883	Washer 7/16 plain	-	-	2	2	2	
5504	Lockwasher 5/16	-	-	2	2	2	
7951	Front fender bracket assembly to radiator cradle screw 7/16-20 x 1-1/4 hex. hd.	-	-	6	6	6	
5508	Lockwasher 7/16	-	-	8	8	8	
242054	Front fender splash front assembly--left	-	-	1	1	1	
242055	Front fender splash front assembly--right ...	-	-	1	1	1	
240538	Front fender splash to dash seal	-	-	2	2	2	
139521	Front fender splash to dash seal rivet 5/32 x 7/16 oval hd. split	-	-	6	6	6	
101200	Front fender splash to dash seal rivet washer	-	-	6	6	6	
5739	Front fender splash to fender screw No. 10-32 x 1/2 hex. hd.	-	-	14	14	14	
7003	Nut No. 10-32	-	-	14	14	14	
5500	Lockwasher No. 10	-	-	14	14	14	

Piece No.	Name	1500	1506	1603	1607	1707	
		1501	1507	1604	1608	1708	
		1502	1508	1605	No. Required		
6653	Washer No. 10 plain	-	-	28	28	28	
242143	Front fender splasher to frame brace	-	-	2	2	2	
5739	Screw No. 10-32 x 1/2 hex. hd.	-	-	2	2	2	
6684	Washer 1/4 special	-	-	2	2	2	
5494	Front fender splasher front support stud 1/4 special	-	-	2	2	2	
7004	Nut	-	-	2	2	2	
216117	Washer	-	-	2	2	2	
239822	Front fender splasher rear assembly--left	-	-	1	1	1	
239823	Front fender splasher rear assembly--right	-	-	1	1	1	
242004	Front fender splasher seal front	-	-	2	2	2	
242014	Front fender splasher seal front retainer	-	-	4	4	4	
242002	Front fender splasher seal intermediate	-	-	2	2	2	
242000	Front fender splasher seal intermediate retainer	-	-	2	2	2	
239785	Front fender splasher seal rear	-	-	2	2	2	
7710	Screw No. 10-32 x 5/8 fill. hd.	-	-	2	2	2	
6103	Nut No. 10-32 special	-	-	2	2	2	
101200	Front fender splasher seal rear screw washer ..	-	-	2	2	2	
242006	Front fender splasher seal rear to frame retainer	-	-	2	-	-	
242007	Front fender splasher seal rear to frame retainer.....	-	-	-	2	2	
303939	Front fender splasher seal rear to frame retainer screw 5/16-18 x 1/2 hex. hd.-- washer type	-	-	6	4	4	
232791	Front fender splasher seal rear to frame retainer screw rear 5/16-18 x 5/8 hex. hd. (Shakeproof) - washer type	-	-	4	4	4	
242005	Front fender splasher seal rear retainer	-	-	2	2	2	
139521	Front fender splasher seal rivet 5/32 x 7/16 oval hd. split	-	-	26	26	26	
242001	Front fender splasher shock absorber baffler ..	-	-	-	2	2	
242008	Front fender splasher shock absorber housing ..	-	-	2	2	2	
239788	Front fender splasher shock absorber housing retainer	-	-	4	4	4	
5739	Screw No. 10-32 x 1/2 hex. hd.	-	-	8	8	8	
300978	Front fender well body bolt hole plug	-	-	2	2	2	
240568	Front fender well to frame bracket--left	-	-	1	1	1	
240569	Front fender well to frame bracket--right	-	-	1	1	1	
240589	Front fender well to frame bracket screw 3/8-24 x 7/8 special hex. hd.	-	-	2	2	2	
7818	Screw 3/8-24 x 7/8 hex. hd.	-	-	2	2	2	
6443	Screw 7/16-20 x 1 hex. hd.	-	-	4	4	4	
3883	Washer 7/16	-	-	4	4	4	
5508	Lockwasher 7/16	-	-	4	4	4	
7006	Nut 3/8-24	-	-	4	4	4	
5506	Lockwasher 3/8	-	-	4	4	4	
3877	Washer 3/8 plain	-	-	8	8	8	
234900	Front fender well wheel cushion	-	-	6	-	-	
234974	Front fender well wheel cushion	-	-	-	6	6	
304001	Front fender well wheel cushion fastener	-	-	24	24	24	
242042	Front fender well wheel pad	-	-	2	-	-	

SERVICE PARTS LIST--PACKARD SUPER-EIGHT AND TWELVE

Fenders 47

Piece No.	Name	1500	1506	1603	1607	1707
		1501	1507	1604	1608	1708
		1502	1508	1605	No. Required	
304001	Front fender well wheel pad clip	-	-	4	-	-
235777	Rear fender left assembly (Specify color) (Used on bodies 1103-12-13-14-15-16-1143)	-	-	1	-	-
235781	Rear fender left assembly (Specify color) (Used on bodies 1117-18-19-1107)	-	-	1	-	-
235779	Rear fender left assembly (Specify color) (Used on bodies 1132-33-34-35-36-1153-1232-33-34-35-36-53)	-	-	-	1	1
235783	Rear fender left assembly (Specify color) (Used on bodies 1137-38-39-1127-1237-38-39-27)	-	-	-	1	1
235778	Rear fender right assembly (Specify color) (Use (Used on bodies 1132-33-34-35-36-1153-1232-33-34-35-36-53)	-	-	-	1	1
235782	Rear fender right assembly (Specify color) (Used on bodies 1137-38-39-1127-1237-38-39-27)	-	-	-	1	1
235780	Rear fender right assembly (Specify color) (Used on bodies 1117-18-19-1107)	-	-	1	-	-
235776	Rear fender right assembly (Specify color) (Used on bodies 1103-12-13-14-15-16-1143) ...	-	-	1	-	-
224885	Rear fender to body liner (Used on bodies 1103-12-13-14-15-16-1132-33-34-35-36-43-53)	-	-	2	2	-
224886	Rear fender to body liner (Used on bodies 1117-18-19-37-38-39-1107-27)	-	-	2	2	-
245225	Rear fender to body liner (Used on 1232-33-34-35-36-53)	-	-	-	-	1
245226	Rear fender to body liner (Used on 1227-37-38-39)	-	-	-	-	1
7809	Rear fender to body screw 5/16-24 x 7/8 hex. hd.	-	-	x	x	x
5449	Screw 5/16-24 x 3/4 hex. hd.	-	-	6	6	6
7861	Screw 5/16-24 x 1 hex. hd.	-	-	x	x	x
7812	Screw 5/16-24 x 1-3/4 hex. hd.	-	-	2	2	2
5504	Lockwasher 5/16	-	-	26	26	26
3909	Washer 5/16 special	-	-	x	x	x
162389	Washer	-	-	x	x	x
6427	Rear fender to body stud 5/16-24	-	-	2	2	2
7005	Nut 5/16-24	-	-	x	x	x
226771	Rear fender pebble guard assembly--left	-	-	1	1	1
226772	Rear fender pebble guard assembly--right	-	-	1	1	1
7827	Screw 1/4-28 x 3/4 hex. hd.	-	-	4	4	4
303939	Screw 5/16-18 x 1/2 hex. hd.	-	-	4	4	4
3870	Washer 1/4 plain special	-	-	6	6	6
5502	Lockwasher 1/4	-	-	4	4	4
7004	Nut 1/4-28	-	-	4	4	4
7600	Rear fender to running board bolt 5/16-24 x 7/8 carriage	-	-	6	6	6
5449	Screw 5/16-24 x 3/4 hex. hd.	-	-	2	2	2
5504	Lockwasher 5/16	-	-	8	8	8
7005	Nut 5/16-24	-	-	8	8	8
3909	Washer 5/16 special	-	-	4	4	4

Piece No.	Name	1500	1506	1603	1607	1707
		1501	1507	1604	1608	1708
		1502	1508	1605	No. Required	
FRAME						
232000	Frame assembly (Use on 1500) (L.H. drive)	1	-	-	-	-
232311	Frame assembly (Use on 1506)	-	1	-	-	-
232001	Frame assembly (Use with bodies 1012-1013) (L.H. drive)	1	-	-	-	-
232690	Frame assembly (Use with bodies 1016-17-18) (L.H. drive)	1	-	-	-	-
237354	Frame assembly (Use with bodies 1007-1019) (L.H. drive)	1	-	-	-	-
232753	Frame assembly (Use with bodies 1036-37-38) ...	-	1	-	-	-
237356	Frame assembly (Use with bodies 1027-1039)	-	1	-	-	-
231479	Frame assembly (Use with bodies 1014-15) (L.H. drive)	1	-	-	-	-
237355	Frame assembly (Use with body 1063-L395) (L.H. drive)	1	-	-	-	-
232309	Frame assembly (Use with bodies 1034-35)	-	1	-	-	-
237357	Frame assembly (Use with body 1073-L395)	-	1	-	-	-
237745	Frame assembly (Used on L394) (L.H. drive)	1	-	-	-	-
237747	Frame assembly (Used on L394)	-	1	-	-	-
237540	Frame assembly (Use with body 1003) (R.H. drive)	1	-	-	-	-
237541	Frame assembly (Use with bodies 1012-1013) (R.H. drive)	1	-	-	-	-
237542	Frame assembly (Use with bodies 1016-17-18) (R.H. drive)	1	-	-	-	-
237543	Frame assembly (Use with bodies 1007-1019)	1	-	-	-	-
237544	Frame assembly (Use with bodies 1014-15)	1	-	-	-	-
237545	Frame assembly (Use with bodies L394-1063)	1	-	-	-	-
237746	Frame assembly (Use with body L394)	1	-	-	-	-
223005	Frame to body hold down bolt bracket	4	4	-	-	-
223007	Frame to body hold down bolt bracket--left	2	1	-	-	-
223500	Frame to body hold down bolt bracket--right ...	2	1	-	-	-
239173	Frame to body hold down bolt bracket--front lt.	-	1	-	-	-
239174	Frame to body hold down bolt bracket--front rt.	-	1	-	-	-
5449	Screw 5/16-24 x 3/4 hex. hd. (Use on 1501 and 1507)	8	8	-	-	-
5504	Lockwasher 5/16 (Use on 1501 and 1507) ...	8	8	-	-	-
7005	Nut 5/16-24 plain (Use on 1501 and 1507) .	8	8	-	-	-
237843	Frame to body hold down bolt No. 2 bracket (Used with bodies L394-L395)	2	2	-	-	-
237841	Frame to body hold down bolt No. 2 spacer (Used with bodies L394-L395)	2	2	-	-	-
232032	Frame brake cable guide	2	2	-	-	-
232003	Frame brake equalizer lever anchor bracket (L.H. drive)	1	1	-	-	-
237464	Frame brake equalizer lever anchor bracket (R.H. drive)	1	-	-	-	-
6039	Screw 5/16-24 x 11/16 hex. hd. (R.H. drive)	2	-	-	-	-
7005	Nut 5/16-24 (R.H. drive)	2	-	-	-	-
6044	Lockwasher 5/16 (Shakeproof) (R.H. drive).	2	-	-	-	-
302493	Frame brake hose union bracket front	2	2	-	-	-
232918	Frame brake hose union bracket rear	1	1	-	-	-

SERVICE PARTS LIST--PACKARD SUPER-EIGHT AND TWELVE

Frame 49

Piece No.	Name	1500	1506	1603	1607	1707	
		1501	1507	1604	1608	1708	
		1502	1508	1605	No. Required		
232060	Frame brake master cylinder bracket (L.H. drive)	1	-	-	-	-	
237424	Frame brake master cylinder bracket (R.H. drive)	1	-	-	-	-	
7872	Screw 3/8-24 x 3/4 hex. hd.	4	-	-	-	-	
7006	Nut 3/8-24	4	-	-	-	-	
6048	Lockwasher 3/8 (Shakeproof)	4	-	-	-	-	
4161	Frame brake master cylinder bracket to shield rivet	2	-	-	-	-	
237849	Frame brake master cylinder shield	1	-	-	-	-	
237098	Frame brake master cylinder support assembly .	-	1	-	-	-	
237388	Frame clutch and brake pedal shaft bracket bolt 3/8-24 x 1-1/4 hex. hd. special	-	3	-	-	-	
6048	Lockwasher 3/8 (Shakeproof)	-	3	-	-	-	
7006	Nut 3/8-24	-	3	-	-	-	
237358	Frame clutch and brake pedal shaft bracket and pin assembly	-	1	-	-	-	
237332	Frame clutch and brake pedal shaft bracket pin.	-	1	-	-	-	
237491	Frame exhaust outlet tube rear support bracket.	1	-	-	-	-	
0242367	Frame front channel assembly (Supersedes 231412)	1	-	-	-	-	
0242368	Frame front channel assembly (Supersedes 237022)	-	1	-	-	-	
234944	Frame front channel steering crank reinforcement	1	-	-	-	-	
237052	Frame front channel steering crank reinforcement	-	1	-	-	-	
232048	Frame gasoline tank support left assembly	1	1	-	-	-	
232049	Frame gasoline tank support right assembly	1	1	-	-	-	
232019	Frame gasoline tank support brace--left	1	1	-	-	-	
232036	Frame gasoline tank support brace--right	1	1	-	-	-	
232002	Frame gasoline tank support strap bracket	2	2	-	-	-	
232178	Frame motor support front bracket--left	-	1	-	-	-	
232179	Frame motor support front bracket--right	-	1	-	-	-	
309862	Frame muffler support bracket assembly	1	-	-	-	-	
309863	Frame muffler support bracket bolt nut	2	-	-	-	-	
231489	Frame rear channel	1	1	-	-	-	
309958	Frame rear axle bumper bolt nut	4	4	-	-	-	
231482	Frame rear intermediate channel	1	1	-	-	-	
309859	Frame shock absorber front bolt nut	8	8	-	-	-	
231480	Frame shock absorber (rear) bolt spacer	4	4	-	-	-	
232624	Frame shock absorber (rear) stabilizer bracket bolt nut	-	2	-	-	-	
231334	Frame side--left (Use on 1500)	1	-	-	-	-	
232314	Frame side--left (Use on 1506)	-	1	-	-	-	
231483	Frame side--left (Use on 1501)	1	-	-	-	-	
232312	Frame side--left (Use on 1507)	-	1	-	-	-	
231424	Frame side--left (Use on 1502)	1	-	-	-	-	
232303	Frame side--left (Use on 1508)	-	1	-	-	-	
231335	Frame side--right (Use on 1500) (L.H. drive) ..	1	-	-	-	-	
237546	Frame side--right (Use on 1500) (R.H. drive) ..	1	-	-	-	-	
232315	Frame side--right (Use on 1506)	-	1	-	-	-	
231484	Frame side--right (Use on 1501) (L.H. drive) ..	1	-	-	-	-	
237547	Frame side--right (Use on 1501) (R.H. drive) ..	1	-	-	-	-	
232313	Frame side--right (Use on 1507)	-	1	-	-	-	
231425	Frame side--right (Use on 1502) (L.H. drive) ..	1	-	-	-	-	
237548	Frame side--right (Use on 1502) (R.H. drive) ..	1	-	-	-	-	
232304	Frame side--right (Use on 1508)	-	1	-	-	-	

50 Frame

SERVICE PARTS LIST--PACKARD SUPER-EIGHT AND TWELVE

Piece No.	Name	1500	1506	1603	1607	1707	
		1501	1507	1604	1608	1708	
		1502	1508	1605			
		No. Required					
231415	Frame side sub-channel front--right (Use with bodies 1003-1012-13-14-15-16-17-18)	1	1	-	-	-	
237569	Frame side sub-channel front--right (Use with bodies 1007-1019-1063-L394-95)	1	-	-	-	-	
232401	Frame side sub-channel front--right (Use with bodies 1023-1032-33-34-35-36-37-38)	-	1	-	-	-	
237571	Frame side sub-channel front--right (Use with bodies 1027-1039-1073-L394-95)	-	1	-	-	-	
231414	Frame side sub-channel front--left (Use with bodies 1003-1012-13-16-17-18-14-15)	1	-	-	-	-	
237568	Frame side sub-channel front--left (Use with bodies 1007-1019-1063-L394-95)	1	-	-	-	-	
232400	Frame side sub-channel front--left (Use with bodies 1032-33-34-35-36-37-38-1023)	-	1	-	-	-	
237570	Frame side sub-channel front--left (Use with bodies 1027-1039-1073-L394-95)	-	1	-	-	-	
232636	Frame side sub-channel rear--left (Use on 1500 and 1506)	1	1	-	-	-	
232638	Frame side sub-channel rear--left (Use on 1501 and 1507)	1	1	-	-	-	
232015	Frame side sub-channel rear--left (Use on 1502- and 1508)	1	1	-	-	-	
232637	Frame side sub-channel rear--right (Use on 1500 and 1506)	1	1	-	-	-	
232639	Frame side sub-channel rear--right (Use on 1501 and 1507)	1	1	-	-	-	
232016	Frame side sub-channel rear--right (Use on 1502 and 1508)	1	1	-	-	-	
232706	Frame spring (rear) bracket front assembly	2	-	-	-	-	
232707	Frame spring (rear) bracket front assembly	-	2	-	-	-	
232708	Frame spring (rear) shackle bracket assembly ..	2	-	-	-	-	
232709	Frame spring (rear) shackle bracket assembly ..	-	2	-	-	-	
237942	Frame stabilizer (lateral) bracket right (Use with bodies 1007-19-23-27-32-33-34-35-36-37-38-39-63-73-L394-L395)	1	1	-	-	-	
237635	Frame stabilizer (lateral) bracket left screw plate (Use with bodies 1007-19-23-27-32-33-34-35-36-37-38-39-63-73-L394-L395).....	1	1	-	-	-	
302745	Frame steering crank mounting plate	1	-	-	-	-	
237038	Frame steering crank mounting plate	-	1	-	-	-	
231491	Frame steering gear bolt spacer	1	1	-	-	-	
234993	Frame vacuum cylinder bracket and cylinder anchor assembly	-	1	-	-	-	
302009	Frame wheel front spring rebound bumper bracket	2	-	-	-	-	
237097	Frame wheel front spring rebound bumper bracket	-	2	-	-	-	
231312	Frame wheel (front) torque arm bracket--left ..	1	-	-	-	-	
237050	Frame wheel (front) torque arm bracket--left ..	-	1	-	-	-	
231313	Frame wheel (front) torque arm bracket--right..	1	-	-	-	-	
237051	Frame wheel (front) torque arm bracket--right..	-	1	-	-	-	
300961	Frame wheel (front) torque arm bracket cap	2	2	-	-	-	
302345	Frame wheel (front) torque arm bracket cap screw 3/8-16 x 1-5/8 hex. hd.	6	6	-	-	-	

SERVICE PARTS LIST--PACKARD SUPER-EIGHT AND TWELVE

Frame 51

Piece No.	Name	1500	1506	1603	1607	1707	
		1501	1507	1604	1608	1708	
		1502	1508	1605	No. Required		
6048	Lockwasher 3/8 (Shakeproof)	6	6	-	-	-	
231441	Frame X member gusset	2	2	-	-	-	
237534	Frame X member leg front--left (Use with bodies 1023-32-33-34-35-36-37-38)	-	1	-	-	-	
237535	Frame X member leg front--left (Use with bodies 1027-1039-1073-L394-L395)	-	1	-	-	-	
232007	Frame X member leg front--left (Use with bodies 1003-1013-12-14-15-16-17-18) (L.H. drive) ...	1	-	-	-	-	
237338	Frame X member leg front--left (Use with bodies 1063-1007-1019-L394-L395) (L.H. drive)	1	-	-	-	-	
237536	Frame X member leg front--left (Use with bodies 1003-12-13-14-15-16-17-18) (R.H. drive)	1	-	-	-	-	
237537	Frame X member leg front--left (Use with bodies 1007-19-63)	1	-	-	-	-	
232006	Frame X member leg front--right (Use with bodies 1003-23-12-13-14-15-16-17-18-32-33-34-35-36- 37-38)	1	1	-	-	-	
232640	Frame X member leg rear--left (Use on 1500 and 1506)	1	1	-	-	-	
237339	Frame X member leg front--right (Use with bodies 1007-19-27-39-63-73-L394-L395)	1	1	-	-	-	
232642	Frame X member leg rear--left (Use with bodies 1012-13-16-17-18-1032-3-6-7-8)	1	1	-	-	-	
237350	Frame X member leg rear--left (Use with bodies 1063-1073-L395)	1	1	-	-	-	
231448	Frame X member leg rear--left (Use with bodies 1014-15-34-35)	1	1	-	-	-	
237352	Frame X member leg rear--left (Use with bodies 1007-1019-27-39-L394)	1	1	-	-	-	
232641	Frame X member leg rear--right (Use on 1500 and 1506)	1	1	-	-	-	
237353	Frame X member leg rear--right (Use with bodies 1007-1019-1027-1039-L394)	1	1	-	-	-	
232643	Frame X member leg rear--right (Use with bodies 1012-13-16-17-18-1032-33-36-37-38)	1	1	-	-	-	
237351	Frame X member leg rear--right (Use with bodies 1063-1073-L395)	1	1	-	-	-	
231449	Frame X member leg rear--right (Use with bodies 1014-15-1034-35)	1	1	-	-	-	
FRAME							
240117	Frame assembly (L.H. drive) (Use with body 1103)	-	-	1	-	-	
240118	Frame assembly (R.H. drive) (Use with body 1103)	-	-	1	-	-	
240102	Frame assembly (L.H. drive) (Use with bodies 1112-1113)	-	-	1	-	-	
240119	Frame assembly (R.H. drive) (Use with bodies 1112-1113)	-	-	1	-	-	
240120	Frame assembly (L.H. drive) (Use with bodies 1116-17-18)	-	-	1	-	-	

Piece No.	Name	1500	1506	1603	1607	1707	
		1501	1507	1604	1608	1708	
		1502	1508	1605	No. Required		
240121	Frame assembly (R.H. drive) (Use with bodies 1116-17-18)	-	-	1	-	-	
240122	Frame assembly (L.H. drive) (Use with bodies 1107-19)	-	-	1	-	-	
240123	Frame assembly (R.H. drive) (Use with bodies 1107-1119)	-	-	1	-	-	
240103	Frame assembly (L.H. drive) (Use with bodies 1114-15)	-	-	1	-	-	
240124	Frame assembly (R.H. drive) (Use with bodies 1114-15)	-	-	1	-	-	
240125	Frame assembly (L.H. drive) (Use with body 1143)	-	-	1	-	-	
240126	Frame assembly (R.H. drive) (Use with body 1143)	-	-	1	-	-	
240089	Frame assembly (Use with bodies 1132-33-1232-33)	-	-	-	1	1	
240127	Frame assembly (Use with bodies 1136-37-38-1236-37-38)	-	-	-	1	1	
240128	Frame assembly (Use with bodies 1127-39-1227-39)	-	-	-	1	1	
240081	Frame assembly (Use with bodies 1134-35-1234-35)	-	-	-	1	1	
240129	Frame assembly (Use with body 1153-1253)	-	-	-	1	1	
223005	Frame to body hold down bolt bracket	-	-	4	4	4	
239173	Frame to body hold down bolt bracket--front left (Use with bodies 1132-33-34-35-36-37-38-1232-33-34-35-36-37-38)	-	-	-	1	1	
239174	Frame to body hold down bolt bracket--front right (Use with bodies 1132-33-34-35-36-37-38-1232-33-34-35-36-37-38)	-	-	-	1	1	
223007	Frame to body hold down bolt bracket--left (Use with bodies 1103-07-12-13-14-15-16-17-18-19-27-32-33-34-35-36-37-38-39-43-53--1232-33-34-35-36-37-38-39-53)	-	-	2	1	1	
223500	Frame to body hold down bolt bracket--right (Use with bodies 1103-07-12-13-14-15-16-17-18-19-27-32-33-34-35-36-37-38-39-43-53--1232-33-34-35-36-37-38-39-53)	-	-	2	1	1	
5449	Screw 5/16-24 x 3/4 hex. hd. (Use on 1604-1607-1707)	-	-	8	8	8	
5504	Lockwasher 5/16 (Use on 1604-1607-1707) ..	-	-	8	8	8	
7005	Nut 5/16-24 (Use on 1604 1607-1707)	-	-	8	8	8	
237529	Frame to body bolt No. 1 nut	-	-	2	2	2	
237843	Frame to body hold down bolt No. 2 bracket (Use with bodies 1107-27-19-39-43-53-1239-53-27) .	-	-	2	2	2	
237841	Frame to body hold down bolt No. 2 spacer (Use with bodies 1107-27-19-39-43-53-1227-39-53) .	-	-	2	2	2	
302493	Frame brake hose union bracket--front	-	-	2	2	2	
232918	Frame brake hose union bracket--rear	-	-	1	1	1	
232060	Frame brake master cylinder bracket (L.H. drive)	-	-	1	-	-	
237424	Frame brake master cylinder bracket (R.H. drive)	-	-	1	-	-	
7872	Screw 3/8-24 x 3/4 hex. hd. (R.H. drive) .	-	-	4	-	-	
7006	Nut 3/8-24 plain (R.H. drive)	-	-	4	-	-	
6048	Lockwasher 3/8 internal (Shakeproof) (R.H. drive)	-	-	4	-	-	

SERVICE PARTS LIST--PACKARD SUPER-EIGHT AND TWELVE

Frame 53

Piece No.	Name	1500	1506	1603	1607	1707
		1501	1507	1604	1608	1708
		1502	1508	1605	No. Required	
237850	Frame brake master cylinder bracket and shield assembly (R.H. drive)	-	-	1	-	-
237849	Frame brake master cylinder shield (R.H. drive)	-	-	1	-	-
0242555	Frame brake master cylinder support assembly (Supersedes 237098)	-	-	-	1	1
230241	Frame brake master cylinder support plug	-	-	-	2	2
232032	Frame brake cable guide	-	-	2	2	2
232003	Frame brake equalizer lever anchor bracket (L.H. drive)	-	-	1	1	1
237464	Frame brake equalizer lever anchor bracket (R.H. drive)	-	-	1	-	-
6039	Screw 5/16-24 x 11/16 hex. hd. (R.H. drive)	-	-	2	-	-
7005	Nut 5/16-24 plain (R.H. drive)	-	-	2	-	-
6044	Lockwasher 5/16 internal (Shakeproof) (R.H. drive)	-	-	2	-	-
237358	Frame clutch and brake pedal shaft bracket and pin assembly	-	-	-	1	1
237388	Frame clutch and brake pedal shaft bracket bolt 3/8-24 x 1-1/4 hex. hd. (special)	-	-	-	3	3
6048	Lockwasher 3/8	-	-	-	3	3
7006	Nut 3/8-24	-	-	-	3	3
237332	Frame clutch and brake pedal shaft bracket pin	-	-	-	1	1
237491	Frame exhaust outlet tube rear support bracket	-	-	1	-	-
240631	Frame fender well support nut washer	-	-	2	2	2
0242369	Frame front channel assembly (Supersedes 240159)	-	-	1	-	-
0242370	Frame front channel assembly (Supersedes 240068)	-	-	-	1	1
240471	Frame front channel radiator support bracket assembly	-	-	1	-	-
234944	Frame front channel steering crank reinforcement	-	-	1	-	-
240080	Frame front channel steering crank reinforcement	-	-	-	1	1
232048	Frame gasoline tank support left assembly	-	-	1	1	1
232049	Frame gasoline tank support right assembly	-	-	1	1	1
232019	Frame gasoline tank support brace--left	-	-	1	1	1
232036	Frame gasoline tank support brace--right	-	-	1	1	1
232002	Frame gasoline tank support strap bracket	-	-	2	2	2
309862	Frame muffler support bracket assembly	-	-	1	-	-
309863	Frame muffler support bracket bolt nut	-	-	2	-	-
231489	Frame rear channel	-	-	1	1	1
309958	Frame rear axle bumper bolt nut	-	-	4	4	4
231482	Frame rear intermediate channel	-	-	1	1	1
232508	Frame shear plate front--left (L.H. drive)	-	-	1	-	-
237532	Frame shear plate front--left (R.H. drive)	-	-	1	-	-
232509	Frame shear plate front--right	-	-	1	1	1
232630	Frame shear plate rear--left (Use on 1604)	-	-	1	-	-
232631	Frame shear plate rear--right (Use on 1604)	-	-	1	-	-
231477	Frame shear plate rear--left (Use on 1605)	-	-	1	-	-
231478	Frame shear plate rear--right (Use on 1605)	-	-	1	-	-
232632	Frame shear plate rear--left (Use on 1607-1707)	-	-	-	1	1
232633	Frame shear plate rear--right (Use on 1607-1707)	-	-	-	1	1
232410	Frame shear plate rear--left (Use on 1608-1708)	-	-	-	1	1
232411	Frame shear plate rear--right (Use on 1608-1708)	-	-	-	1	1
309859	Frame shock absorber front bolt nut	-	-	8	8	8

Piece No.	Name	1500	1506	1603	1607	1707	
		1501	1507	1604	1608	1708	
		1502	1508	1605	No. Required		
231480	Frame shock absorber (rear) bolt spacer	-	-	4	4	4	
231334	Frame side--left (Use on 1603)	-	-	1	-	-	
231335	Frame side--right (Use on 1603) (L.H. drive) ..	-	-	1	-	-	
237546	Frame side--right (R.H. drive) (Use on 1603) ..	-	-	1	-	-	
231483	Frame side--left (Use on 1604)	-	-	1	-	-	
231484	Frame side--right (L.H. drive) (Use on 1604) ..	-	-	1	-	-	
237547	Frame side--right (R.H. drive) (Use on 1604) ..	-	-	1	-	-	
231424	Frame side--left (Use on 1605)	-	-	1	-	-	
237548	Frame side--right (R.H. drive) (Use on 1605) ..	-	-	1	-	-	
231425	Frame side--right (L.H. drive) (Use on 1605) ..	-	-	1	-	-	
240045	Frame side--left (Use on 1607-1707)	-	-	-	1	1	
240046	Frame side--right (Use on 1607-1707)	-	-	-	1	1	
240047	Frame side--left (Use on 1608-1708)	-	-	-	1	1	
240048	Frame side--right (Use on 1608-1708)	-	-	-	1	1	
240172	Frame side sub-channel front--right (Use with bodies 1103-12-13-14-15-16-17-18)	-	-	1	-	-	
240175	Frame side sub-channel front--right (Use with bodies 1107-19-43)	-	-	1	-	-	
240070	Frame side sub-channel front--right (Use with bodies 1132-33-34-35-36-37-38-1232-33-34-35- 36-37-38)	-	-	-	1	1	
240174	Frame side sub-channel front--right (Use with bodies 1127-39-53-1227-39-53)	-	-	-	1	1	
240170	Frame side sub-channel front--left (Use with bodies 1103-12-13-14-15-16-17-18)	-	-	1	-	-	
240171	Frame side sub-channel front--left (Use with bodies 1107-19-43)	-	-	1	-	-	
240069	Frame side sub-channel front--left (Use with bodies 1132-33-34-35-36-37-38-1232-33-34-35- 36-37-38)	-	-	-	1	1	
240173	Frame side sub-channel front--left (Use with bodies 1127-39-53-1227-39-53)	-	-	-	1	1	
232636	Frame side sub-channel rear--left (Use on 1603)	-	-	1	-	-	
232638	Frame side sub-channel rear--left (Use on 1604- 1607-1707)	-	-	1	1	1	
232015	Frame side sub-channel rear--left (Use on 1605- 1608-1708)	-	-	1	1	1	
232637	Frame side sub-channel rear--right (Use on 1603)	-	-	1	-	-	
232639	Frame side sub-channel rear--right (Use on 1604- 1607-1707)	-	-	1	1	1	
232016	Frame side sub-channel rear--right (Use on 1605- 1608-1708)	-	-	1	1	1	
232706	Frame spring (rear) bracket front assembly	-	-	2	-	-	
232707	Frame spring (rear) bracket front assembly	-	-	-	2	2	
232708	Frame spring (rear) shackle bracket assembly ..	-	-	2	-	-	
232709	Frame spring (rear) shackle bracket assembly ..	-	-	-	2	2	
237942	Frame stabilizer (lateral) bracket--right	-	-	1	1	1	
232624	Frame stabilizer (lateral) bracket to frame bolt clinch nut 7/16-20	-	-	1	2	2	
237635	Frame stabilizer (lateral) bracket left screw plate	-	-	1	1	1	
302745	Frame steering crank mounting plate	-	-	1	-	-	

SERVICE PARTS LIST--PACKARD SUPER-EIGHT AND TWELVE

Frame 55

Piece No.	Name	1500	1506	1603	1607	1707
		1501	1507	1604	1608	1708
		1502	1508	1605	No. Required	
240074	Frame steering crank mounting plate	-	-	-	1	1
231491	Frame steering gear bolt spacer	-	-	1	-	-
240630	Frame steering gear bolt spacer	-	-	-	1	1
234993	Frame vacuum cylinder bracket and cylinder anchor assembly	-	-	-	1	1
302009	Frame wheel front spring rebound bumper bracket	-	-	2	-	-
237097	Frame wheel front spring rebound bumper bracket	-	-	-	2	2
231312	Frame wheel (front) torque arm bracket--left ..	-	-	1	-	-
231313	Frame wheel (front) torque arm bracket--right .	-	-	1	-	-
237050	Frame wheel (front) torque arm bracket--left ..	-	-	-	1	1
237051	Frame wheel (front) torque arm bracket--right ..	-	-	-	1	1
300961	Frame wheel (front) torque arm bracket cap	-	-	2	2	2
302345	Frame wheel (front) torque arm bracket cap screw 3/8-16 x 1-5/8 hex. hd.	-	-	6	6	6
6048	Lockwasher 3/8 internal (Shakeproof)	-	-	6	6	6
231441	Frame X member gusset	-	-	2	2	2
232007	Frame X member leg front--left (L.H. drive) (Use with bodies 1103-12-13-14-15-1116-17-18)	-	-	1	-	-
237536	Frame X member leg front--left (R.H. drive) (Use with bodies 1103-12-13-14-15-1116-17-18)	-	-	1	-	-
237338	Frame X member leg front--left (L.H. drive) (Use with bodies 1143-1107-1119)	-	-	1	-	-
237537	Frame X member leg front--left (R.H. drive) (Use with bodies 1107-19-43)	-	-	1	-	-
237534	Frame X member leg front--left (Use with bodies 1132-33-34-35-36-37-38-1232-33-34-35-36-37-38)	-	-	-	1	1
237535	Frame X member leg front--left (Use with bodies 1127-39-53-1227-39-53)	-	-	-	1	1
232006	Frame X member leg front--right (Use with bodies 1103-12-13-14-15-16-17-18-32-33-34-35-36-37-38-1232-33-34-35-36-37-38)	-	-	1	1	1
237339	Frame X member leg front--right (Use with bodies 1107-19-27-39-43-53-1227-39-53)	-	-	1	1	1
232640	Frame X member leg rear--left (Use with 1603) .	-	-	1	-	-
232642	Frame X member leg rear--left (Use with bodies 1112-13-16-17-18-32-33-36-37-38-1232-33-36-37-38)	-	-	1	1	1
237350	Frame X member leg rear--left (Use with bodies 1143-1153-1253)	-	-	1	1	1
231448	Frame X member leg rear--left (Use with bodies 1114-15-34-35-1234-35)	-	-	1	1	1
237352	Frame X member leg rear--left (Use with bodies 1107-19-27-39-1227-39)	-	-	1	1	1
232641	Frame X member leg rear--right (Use on 1603) ..	-	-	1	-	-
237353	Frame X member leg rear--right (Use with bodies 1107-19-27-39-1227-39)	-	-	1	1	1
232643	Frame X member leg rear--right (Use with bodies 1112-13-16-17-18-32-33-36-37-38-1232-33-36-37-38).....	-	-	1	1	1
		-	-	1	1	1

Piece No.	Name	1500	1506	1603	1607	1707	
		1501	1507	1604	1608	1708	
		1502	1508	1605	No. Required		
237351	Frame X member leg rear--right (Use with bodies 1143-53-1253)	-	-	1	1	1	
231449	Frame X member leg rear--right (Use with bodies 1114-15-34-35-1234-35)	-	-	1	1	1	
GASOLINE							
228754	Gasoline fuel pump inlet tube assembly	1	-	1	-	-	
228755	Gasoline fuel pump inlet tube assembly	-	1	-	1	1	
232073	Gasoline tank assembly	1	-	-	-	-	
239826	Gasoline tank assembly	-	-	1	-	-	
232074	Gasoline tank assembly	-	1	-	-	-	
239825	Gasoline tank assembly	-	-	-	1	1	
5422	Gasoline tank drain plug pipe plug (1/4-18) hex. hd.	1	1	1	1	1	
232299	Gasoline tank gauge assembly	1	-	-	-	-	
242066	Gasoline tank gauge assembly	-	-	1	-	-	
232300	Gasoline tank gauge assembly	-	1	-	-	-	
242067	Gasoline tank gauge assembly	-	-	-	1	1	
5569	Screw No. 10-32 x 1/2 fill. hd.	5	5	5	5	5	
300426	Gasoline tank gauge assembly screw gasket	5	5	5	5	5	
7003	Gasoline tank gauge binding post nut	1	1	1	1	1	
5935	Lockwasher No. 10 (Shakeproof)	1	1	1	1	1	
303289	Gasoline tank gauge gasket	1	1	-	-	-	
242235	Gasoline tank gauge gasket	-	-	1	1	1	
230438	Gasoline tank inlet cap assembly	1	1	1	1	1	
232487	Gasoline tank inlet hose	1	1	1	1	1	
304218	Gasoline tank inlet hose clamp	2	2	2	2	2	
232280	Gasoline tank inlet tube inner	1	1	1	1	1	
232288	Gasoline tank inlet tube outer assembly	1	1	1	1	1	
232232	Gasoline tank inlet tube to fender grommet	1	1	1	1	1	
232121	Gasoline tank support strap assembly	2	-	2	-	-	
232342	Gasoline tank support strap assembly	-	2	-	2	2	
232154	Gasoline tank support strap anchor pin	2	2	2	2	2	
303347	Gasoline tank support strap anti-squeak	4	4	4	4	4	
7006	Nut 3/8-24	2	2	2	2	2	
5506	Lockwasher 3/8	2	2	2	2	2	
232345	Gasoline tube assembly (Use on 1500)	1	-	-	-	-	
240746	Gasoline tube assembly (Use on 1603)	-	-	1	-	-	
232346	Gasoline tube assembly (Use on 1501)	1	-	-	-	-	
240747	Gasoline tube assembly (Use on 1604)	-	-	1	-	-	
240748	Gasoline tube assembly (Use on 1605)	-	-	1	-	-	
232347	Gasoline tube assembly (Use on 1502)	1	-	-	-	-	
232348	Gasoline tube assembly (Use on 1506)	-	1	-	-	-	
232349	Gasoline tube assembly (Use on 1507)	-	1	-	-	-	
240328	Gasoline tube assembly (Use on 1607-1707)	-	-	-	1	1	
232350	Gasoline tube assembly (Use on 1508)	-	1	-	-	-	
240252	Gasoline tube assembly (Use on 1608-1708)	-	-	-	1	1	
320547	Gasoline tube clip 5/16 single boltless	4	-	4	-	-	
105161	Gasoline tube clip	-	-	-	1	1	
209611	Gasoline tube clip 3/8 single boltless	-	7	-	7	7	

SERVICE PARTS LIST--PACKARD SUPER-EIGHT AND TWELVE

Instrument Board 57

Piece No.	Name	1500	1506	1603	1607	1707	
		1501	1507	1604	1608	1708	
		1502	1508	1605	No. Required		
139466	Gasoline tube clip	4	-	4	-	-	
7710	Screw No. 10-32 x 5/8 fill. hd.	1	-	1	-	-	
5500	Lockwasher 3/16	1	-	1	-	-	
7003	Nut No. 10-32	1	-	1	-	-	
225465	Gasoline tube connection--front	1	-	1	-	-	
225642	Gasoline tube connection--front	-	1	-	1	1	
5466	Gasoline tube nut--rear	1	-	1	-	-	
5468	Gasoline tube nut--rear	-	1	-	1	1	
232919	Gasoline tube to frame front channel clip R.H. side	-	1	-	-	-	
304711	Gasoline tube to frame clip screw 5/16-18 x 1/2 hex. hd. washer type	-	1	-	1	1	
216655	Gasoline tube to frame shield	-	1	-	-	-	
229302	Gasoline tube frame shield screw 1/4-20 x 1/2 long self-tapping	-	2	-	-	-	
216655	Gasoline tube assembly to frame clamp plate ...	-	-	-	1	1	
229302	Screw 1/4-20 x 1/2 (Shakeproof)	-	-	-	2	2	

INSTRUMENT BOARD

229972	Instrument board assembly (Not used on 1019-39)	1	1	-	-	-
229973	Instrument board assembly (Used on 1019-39- 1063-73-1007-1027)	1	1	-	-	-
6039	Screw 5/16-24 x 11/16 hex. hd.	4	4	-	-	-
3874	Washer 5/16 plain	4	4	-	-	-
5504	Lockwasher 5/16	4	4	-	-	-
0232329	Instrument board ammeter	1	1	-	-	-
3939	Instrument board ammeter terminal washer	2	2	-	-	-
5500	Lockwasher 3/16	2	2	-	-	-
5416	Nut No. 10-32 hex. hd.	2	2	-	-	-
232378	Instrument board cigar lighter assembly	1	1	-	-	-
0239616	Instrument board cigar lighter tip (Supersedes 232380)	1	1	-	-	-
232381	Instrument board cigar lighter tip and knob assy.	1	1	-	-	-
232226	Instrument board clock	1	1	-	-	-
0239048	Instrument board clock dial	1	1	-	-	-
225007	Instrument board clock gasket	1	1	-	-	-
5310	Instrument board clock screw No. 8-32 x 1/4 rnd. hd.	3	3	-	-	-
6472	Lockwasher No. 8 (Shakeproof)	3	3	-	-	-
3911	Instrument board clock reset washer	1	1	-	-	-
0230060	Instrument board clock glass	1	1	-	-	-
195680	Instrument board compartment to dash panel bracket	2	2	-	-	-
7842	Screw 1/4-28 x 1-1/4 hex. hd.	2	2	-	-	-
5667	Screw No. 10-32 x 5/8 rnd. hd.	2	2	-	-	-
5502	Lockwasher 1/4	2	2	-	-	-
5500	Lockwasher 3/16	2	2	-	-	-
3867	Washer 3/16 special	4	4	-	-	-
7003	Nut No. 10-32	2	2	-	-	-

Piece No.	Name	1500	1506	1603	1607	1707	
		1501	1507	1604	1608	1708	
		1502	1508	1605	No. Required		
235360	Instrument board compartment door anti-rattler--inner	2	2	-	-	-	
312760	Instrument board compartment door anti-rattler--outer (Supersedes 235273)	2	2	-	-	-	
220870	Instrument board compartment door frame--right.	1	1	-	-	-	
235371	Instrument board compartment door frame--left .	1	1	-	-	-	
226083	Instrument board compartment door hinge assembly--left	1	1	-	-	-	
220750	Instrument board compartment door hinge assembly--right	1	1	-	-	-	
5619	Screw No. 8-32 x 5/16 flat hd.	4	4	-	-	-	
5601	Screw No. 10-32 x 3/8 rnd. hd.	4	4	-	-	-	
7003	Nut No. 10-32	4	4	-	-	-	
5500	Lockwasher No. 10	4	4	-	-	-	
312782	Instrument board compartment door knob (key lock type)	2	2	-	-	-	
314336	Instrument board compartment door knob escut. .	2	2	-	-	-	
229255	Instrument board compartment door knob lock key	2	2	-	-	-	
235409	Instrument board compartment door lock striker.	2	2	-	-	-	
5676	Screw No. 10-32 x 3/8 rnd. hd.	2	2	-	-	-	
6056	Lockwasher No. 10 (Shakeproof)	2	2	-	-	-	
199114	Screw boss No. 10-32	2	2	-	-	-	
235410	Instrument board compartment door panel assembly--right	1	1	-	-	-	
235411	Instrument board compartment door panel assembly--left	1	1	-	-	-	
6594	Screw No. 8-32 x 5/16 oval hd.	8	8	-	-	-	
5860	Lockwasher No. 8 countersunk (Shakeproof).	8	8	-	-	-	
235361	Instrument board compartment door panel liner .	2	2	-	-	-	
0232334	Instrument board gasoline gauge	1	-	-	-	-	
0232333	Instrument board gasoline gauge	-	1	-	-	-	
0232335	Instrument gasoline gauge (Imperial gallons) ..	1	-	-	-	-	
0232334	Instrument gasoline gauge (Imperial gallons) ..	-	1	-	-	-	
0228509	Instrument board gauge glass	2	2	-	-	-	
0228510	Instrument board gauge glass gasket	2	2	-	-	-	
0234858	Instrument board gauge mask (Park and City) ...	1	1	-	-	-	
0234891	Instrument board gauge mask (Drive and Pass.) .	1	1	-	-	-	
237272	Instrument board headlamp switch and bracket assembly	1	1	-	-	-	
5631	A → Screw No. 10-32 x 1/4 rnd. hd.	2	2	-	-	-	
5500	Lockwasher No. 10	2	2	-	-	-	
237271	Instrument board headlamp switch knob assembly.	1	1	-	-	-	
237295	Instrument board headlamp switch lock nut 7/16-20 plain	1	1	-	-	-	
5806	Instrument board headlamp switch lockwasher 7/16 (Shakeproof)	1	1	-	-	-	
0225600	Instrument board light shield and socket assembled	2	2	-	-	-	
0225601	Instrument board light wire and socket assembled	2	2	-	-	-	
0232330	Instrument board oil pressure gauge	1	1	-	-	-	

SERVICE PARTS LIST--PACKARD SUPER-EIGHT AND TWELVE

Instrument Board 59

Piece No.	Name	1500	1506	1603	1607	1707	
		1501	1507	1604	1608	1708	
		1502	1508	1605	No. Required		
*225251	Instrument board oil pressure tube lower assembly (Supersedes 232383 and 237935)	1	-	-	-	-	
219164	Instrument board oil pressure gauge tube dash elbow	1	-	-	-	-	
219165	Instrument board oil pressure gauge tube dash elbow	-	1	-	-	-	
7007	Nut	1	1	-	-	-	
5806	Lockwasher 7/16 (Shakeproof)	1	1	-	-	-	
3883	Instrument board oil pressure gauge tube dash elbow washer 7/16	1	1	-	-	-	
232385	Instrument board oil pressure gauge tube lower assembly	-	1	-	-	-	
194974	Instrument board oil pressure gauge tube lower assembly clip (L.H. drive)	1	1	-	-	-	
70128	Clip (R.H. drive for 1500-1-2)	1	2	-	-	-	
5984	Screw No. 6 x 3/8 rnd. hd. (Parker Kalon) (L.H. drive)	1	1	-	-	-	
7005	Nut 5/16-24	-	2	-	-	-	
7004	Nut 1/4-28 (R.H. drive)	1	-	-	-	-	
5504	Lockwasher 5/16	-	2	-	-	-	
5502	Lockwasher 1/4 (R.H. drive)	1	-	-	-	-	
6722	Instrument board oil pressure gauge tube assembly connection 1/4 flared tube union ...	1	-	-	-	-	
225250	Instrument board oil pressure gauge tube assembly connection	-	1	-	-	-	
157477	Instrument board oil pressure gauge tube assembly union nut 1/4	2	2	-	-	-	
216887	Instrument board oil pressure gauge tube lower anti-squeak	x	x	-	-	-	
225454	Instrument board oil pressure gauge tube connector adapter	2	2	-	-	-	
▲215844	Instrument board oil pressure gauge tube connector adapter	1	-	-	-	-	
215546	Instrument board oil pressure gauge tube lower hose assembly	1	-	-	-	-	
225253	Instrument board oil pressure gauge tube (upper) assembly (L.H. drive)	1	1	-	-	-	
228676	Instrument board oil pressure gauge tube (upper) assembly (R.H. drive)	1	-	-	-	-	
157477	Instrument board oil pressure gauge tube (upper) assembly union nut 1/4	2	2	-	-	-	
225454	Instrument board oil pressure gauge tube upper connector adapter	2	2	-	-	-	
232224	Instrument board panel assembly	1	-	-	-	-	
232328	Instrument board panel assembly (20 Imperial gallon gauge)	1	-	-	-	-	
232225	Instrument board panel assembly	-	1	-	-	-	

▲This part used only with pc. No. 225251 oil pressure gauge tube lower and 215546 hose
 *When replacing this part on cars without hose also order 1 each of 215844 adapter and 215546 hose.

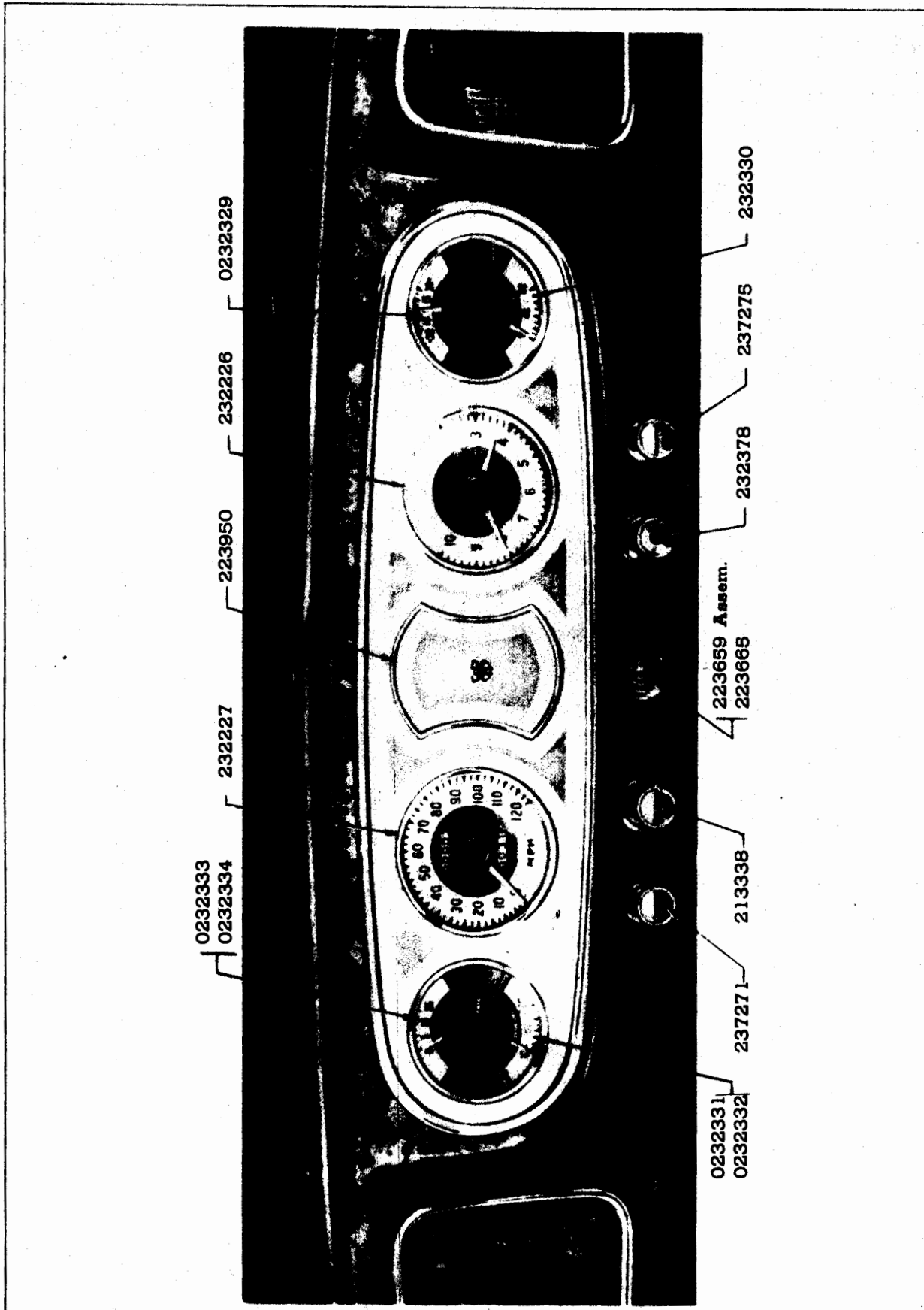

Models 1500-1-2-6-7-8

1937 508 & 12
237232

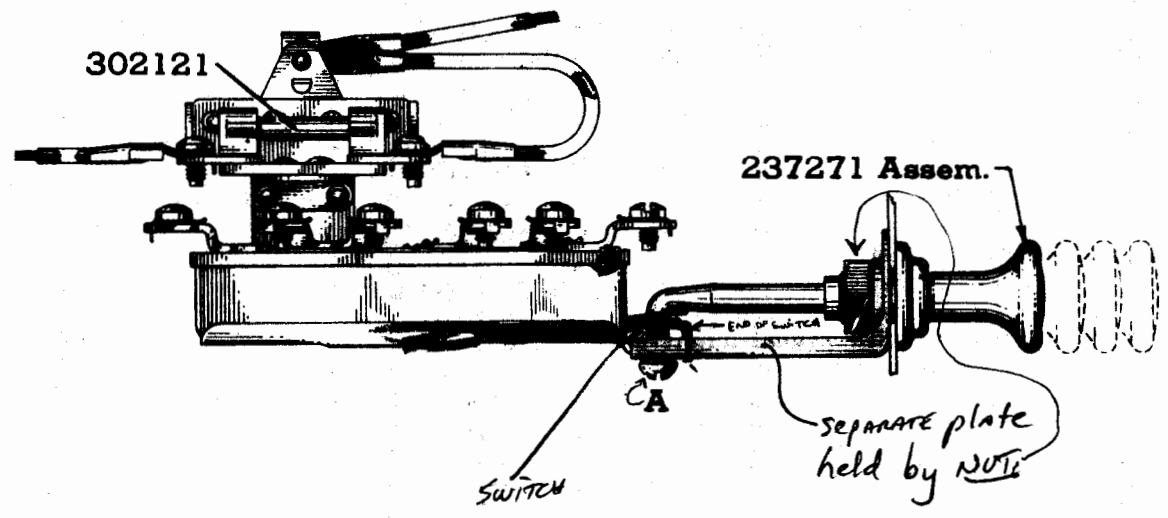
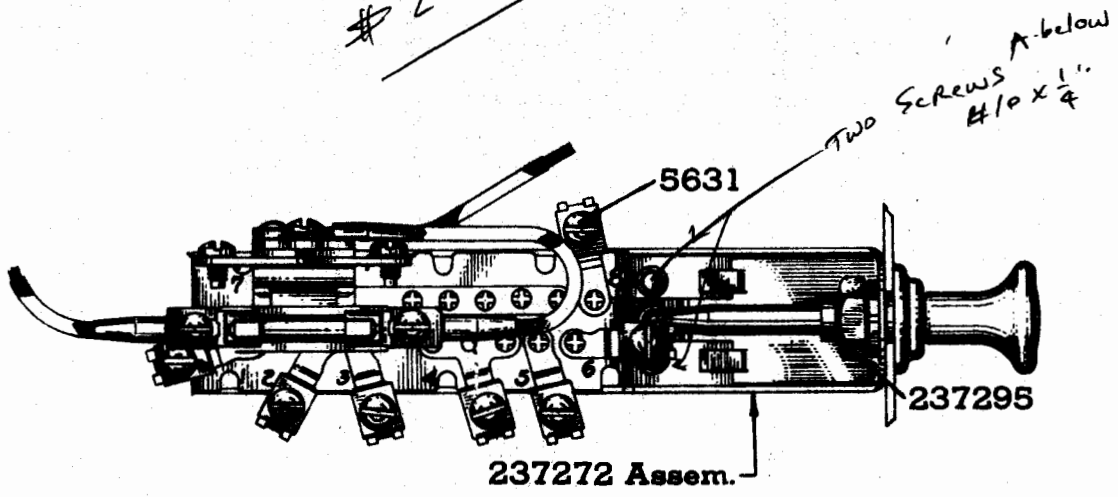

Piece No.	Name	1500	1506	1603	1607	1707	
		1501	1507	1604	1608	1708	
		1502	1508	1605	No. Required		
232327	Instrument board panel assembly (25 Imperial gallon gauge)	-	1	-	-	-	
7003	Nut No. 10-32	4	4	-	-	-	
6056	Lockwasher No. 10 (Shakeproof)	2	2	-	-	-	
5818	Lockwasher No. 10 (Shakeproof) (Wood type)	2	2	-	-	-	
102590	Instrument board panel light bulb	4	4	-	-	-	
232362	Instrument board panel light switch assembly-- Rheostat	1	1	-	-	-	
225190	Screw No. 8-32 x 5/16	2	2	-	-	-	
5861	Lockwasher No. 8 (Shakeproof)	2	2	-	-	-	
0228511	Instrument board panel mounting plate and face assembly	1	1	-	-	-	
231541	Instrument board to pillar anti-squeak	4	4	-	-	-	
223950	Instrument board radio hole cover assembly	1	1	-	-	-	
223940	Instrument board radio hole cover finishing plate	1	1	-	-	-	
223933	Instrument board radio hole cover finishing plate emblem	1	1	-	-	-	
223930	Instrument board radio hole cover finishing plate moulding	1	1	-	-	-	
225183	Instrument board radio hole cover finishing plate gasket	1	1	-	-	-	
225005	Instrument board radio hole cover gasket	1	1	-	-	-	
7003	Instrument board radio hole cover nut No. 10-32	2	2	-	-	-	
6056	Lockwasher No. 10 (Shakeproof)	2	2	-	-	-	
102590	Instrument board reading light bulb	1	1	-	-	-	
223789	Instrument board reading light housing assembly	1	1	-	-	-	
225190	Instrument board reading light housing screw No. 8-32 x 5/16	2	2	-	-	-	
7002	Nut No. 8-32	2	2	-	-	-	
6472	Lockwasher No. 8 (Shakeproof)	2	2	-	-	-	
231300	Instrument board reading light socket and cable assembly	1	1	-	-	-	
36111	Instrument board reading light socket and cable assembly insulator	1	1	-	-	-	
223787	Instrument board reading light socket retainer.	1	1	-	-	-	
182459	Instrument board reading light switch assembly.	1	1	-	-	-	
223889	Instrument board signal light bulb 7V, G-3-1/2 single contact Mazda No. 51	4	4	-	-	-	
232227	Instrument board speedometer (Miles per hour) .	1	1	-	-	-	
232228	Instrument board speedometer (Kilometers per hour)	1	1	-	-	-	
237130	Instrument board speedometer driving shaft 75-1/2" long	1	1	-	-	-	
5198	Screw No. 10-32 x 5/8 hex. hd.	1	-	-	-	-	
5500	Lockwasher No. 10	1	-	-	-	-	
7003	Nut No. 10-32	1	-	-	-	-	
0239055	Instrument board speedometer driving shaft cable 76-17/64" long overall, Used in 75-1/2" long shaft	1	1	-	-	-	
209851	Instrument board speedometer driving shaft clip	3	3	-	-	-	

SERVICE PARTS LIST--PACKARD SUPER-EIGHT AND TWELVE

Instrument Board 63

Piece No.	Name	1500	1506	1603	1607	1707	
		1501	1507	1604	1608	1708	
		1502	1508	1605	No. Required		
190231	Instrument board speedometer driving shaft toe board bushing	1	1	-	-	-	
225007	Instrument board speedometer gasket	1	1	-	-	-	
0230060	Instrument board speedometer glass	1	1	-	-	-	
3911	Instrument board speedometer reset washer	1	1	-	-	-	
5310	Instrument board speedometer screw No. 8-32 x 1/4 rnd. hd.	3	3	-	-	-	
6472	Lockwasher No. 8 (Shakeproof)	3	3	-	-	-	
207800	Instrument board starter motor switch	1	1	-	-	-	
213340	Instrument board starter motor switch base	1	1	-	-	-	
213338	Instrument board starter motor switch button ..	1	1	-	-	-	
225833	Instrument board starter motor switch washer ..	1	1	-	-	-	
223737	Instrument board steering post bracket support.	1	1	-	-	-	
5764	Screw 1/4-28 x 3/4 oval hd.	2	2	-	-	-	
5873	Screw 1/4-28 x 9/16 hex. hd.	2	2	-	-	-	
5502	Lockwasher 1/4	4	4	-	-	-	
7004	Nut 1/4-28	2	2	-	-	-	
223714	Instrument board steering post bracket support liner	2	2	-	-	-	
237275	Instrument board-throttle control knob and cable assembly	1	1	-	-	-	
237295	Lock nut 7/16-20	1	1	-	-	-	
5506	Lockwasher 3/8	1	1	-	-	-	
0232331	Instrument board thermometer	1	-	-	-	-	
0232332	Instrument board thermometer	-	1	-	-	-	

INSTRUMENT BOARD

235769	Instrument board assembly	-	-	1	1	-
243964	Instrument board assembly	-	-	-	-	1
6039	Screw 5/16-24 x 11/16 hex. hd.	-	-	4	4	4
3874	Washer 5/16 plain	-	-	4	4	4
5504	Lockwasher 5/16	-	-	4	4	4
4819	Woodscrew No. 10 x 3/4 flat hd.	-	-	13	13	13
0242153	Instrument board ammeter	-	-	1	1	-
0242875	Instrument board ammeter	-	-	-	-	1
3939	Instrument board ammeter terminal washer	-	-	2	2	2
5500	Lockwasher No. 10	-	-	2	2	2
5416	Nut No. 10-32	-	-	2	2	2
240524	Instrument board ammeter and temperature gauge assembly	-	-	1	-	-
240659	Instrument board ammeter and temperature gauge assembly	-	-	-	1	-
242437	Instrument board ammeter and temperature gauge assembly	-	-	-	-	1
5310	Instrument board ammeter and temperature gauge assembly screw No. 8-32 x 1/4 rnd. hd.	-	-	-	-	4
6472	Lockwasher No. 8 (Shakeproof)	-	-	-	-	4
0242150	Instrument board ammeter and temperature gauge case.....	-	-	1	1	1

Piece No.	Name	1500	1506	1603	1607	1707	
		1501	1507	1604	1608	1708	
		1502	1508	1605	No. Required		
0242151	Instrument board ammeter and temperature gauge dial (false)	-	-	1	1	-	
0242873	Instrument board ammeter and temperature gauge dial (false)	-	-	-	-	1	
0242156	Instrument board ammeter and temperature gauge dial (glass)	-	-	1	1	-	
0242877	Instrument board ammeter and temperature gauge dial (glass)	-	-	-	-	1	
0242168	Instrument board ammeter and temperature gauge dial gasket (false)	-	-	1	1	1	
0242152	Instrument board ammeter and temperature gauge face plate	-	-	1	1	-	
0242874	Instrument board ammeter and temperature gauge face plate	-	-	-	-	1	
0242179	Instrument board ammeter and temperature gauge glass	-	-	1	1	1	
0242180	Instrument board ammeter and temperature glass bezel	-	-	1	1	1	
0242182	Instrument board ammeter and temperature gauge glass bezel gasket (rubber)	-	-	1	1	1	
0242181	Instrument board ammeter and temperature gauge glass gasket	-	-	1	1	1	
232378	Instrument board cigar lighter assembly	-	-	1	1	1	
327622	Instrument board cigar lighter assembly resistor (Use with 12 Volt Equipment)	-	-	1	-	-	
242093	Instrument board cigar lighter to resistor cable assembly (Use with 12 Volt Equipment) .	-	-	1	-	-	
225377	Instrument board cigar lighter to resistor cable terminal (Use with 12 Volt Equipment) .	-	-	2	-	-	
36111	Terminal insulator (Use with 12 Volt Equipment)	-	-	2	-	-	
0239616	Instrument board cigar lighter tip	-	-	1	1	1	
232381	Instrument board cigar lighter tip and knob asb.	-	-	1	1	1	
240520	Instrument board clock (Use with 6 Volt Equipt.)	-	-	1	1	-	
242434	Instrument board clock (Use with 6 Volt Equipt.)	-	-	-	-	1	
242104	Instrument board clock (Use with 12 Volt Equipment)	-	-	1	-	-	
5310	Screw No. 8-32 x 1/4 rnd. hd.	-	-	4	4	4	
6472	Lockwasher No. 8 (Shakeproof)	-	-	4	4	4	
0242179	Instrument board clock glass	-	-	1	1	1	
0242180	Instrument board clock glass bezel	-	-	1	1	1	
0242182	Instrument board clock glass bezel gasket (rubber)	-	-	1	1	1	
0242181	Instrument board clock glass gasket	-	-	1	1	1	
312760	Instrument board compartment door anti-rattler.	-	-	4	4	4	
235670	Instrument board compartment door panel--right.	-	-	1	1	-	
243962	Instrument board compartment door panel--right.	-	-	-	-	1	
235671	Instrument board compartment door panel--left .	-	-	1	1	-	
243963	Instrument board compartment door panel--left .	-	-	-	-	1	
235863	Instrument board compartment door hinge asb. ..	-	-	2	2	2	
6594	Screw No. 8-32 x 5/16 oval hd.	-	-	8	8	8	
5619	Screw No. 8-32 x 5/16 flat hd.	-	-	4	4	4	

SERVICE PARTS LIST--PACKARD SUPER-EIGHT AND TWELVE

Instrument Board 65

Piece No.	Name	1500	1506	1603	1607	1707	
		1501	1507	1604	1608	1708	
		1502	1508	1605	No. Required		
5601	Screw No. 10-32 x 3/8 rnd. hd.	-	-	4	4	4	
5860	Lockwasher No. 8 countersunk (Shakeproof) ..	-	-	8	8	8	
7003	Nut No. 10-32	-	-	4	4	4	
5500	Lockwasher No. 10	-	-	4	4	4	
312782	Instrument board compartment door knob (key locking type)	-	-	2	2	2	
314336	Instrument board compartment door knob escut. .	-	-	2	2	2	
229255	Instrument board compartment door knob lock key	-	-	2	2	2	
314149	Instrument board compartment door lock cup	-	-	2	2	2	
6379	Screw No. 6-32 x 5/16 rnd. hd.	-	-	1	1	1	
3516	Lockwasher No. 6	-	-	1	1	1	
235722	Instrument board compartment door lock striker.	-	-	2	2	2	
6716	Screw No. 10-32 x 7/16 oval hd.	-	-	2	2	2	
240324	Instrument board control panel assembly	-	-	1	1	1	
0242161	Instrument board gasoline gauge	-	-	1	1	-	
0242879	Instrument board gasoline gauge	-	-	-	-	1	
240523	Instrument board gasoline and oil gauge asb. ..	-	-	1	1	-	
242438	Instrument board gasoline and oil gauge asb. ..	-	-	-	-	1	
0242157	Instrument board gasoline and oil gauge case ..	-	-	1	1	1	
0242151	Instrument board gasoline and oil gauge dial (false)	-	-	1	1	-	
0242873	Instrument board gasoline and oil gauge dial (false)	-	-	-	-	1	
0242159	Instrument board gasoline and oil gauge dial (glass)	-	-	1	1	1	
0242168	Instrument board gasoline and oil gauge dial gasket (false)	-	-	1	1	1	
0242158	Instrument board gasoline and oil gauge face plate	-	-	1	1	-	
0242878	Instrument board gasoline and oil gauge face plate	-	-	-	-	1	
0242179	Instrument board gasoline and oil gauge glass	-	-	1	1	1	
0242180	Instrument board gasoline and oil gauge glass bezel	-	-	1	1	1	
0242182	Instrument board gasoline and oil gauge glass bezel gasket (rubber)	-	-	1	1	1	
0242181	Instrument board gasoline and oil gauge glass gasket	-	-	1	1	1	
242080	Instrument board gasoline and oil gauge resistor (With 12 Volt Equipment)	-	-	1	-	-	
223889	Instrument board headlight indicator lamp bulb 6 Volt - 8 C.P.	-	-	4	4	4	
327570	Instrument board headlight indicator lamp bulb 12 Volt - 8 C.P.	-	-	4	-	-	
240641	Instrument board headlight (pass) indicator lamp cable and socket assembly	-	-	1	1	1	
316556	Instrument board headlight indicator lamp cable socket	-	-	1	1	1	
225262	Instrument board headlight indicator lamp cable socket contact	-	-	1	1	1	
225263	Instrument board headlight indicator lamp cable socket spring	-	-	1	1	1	

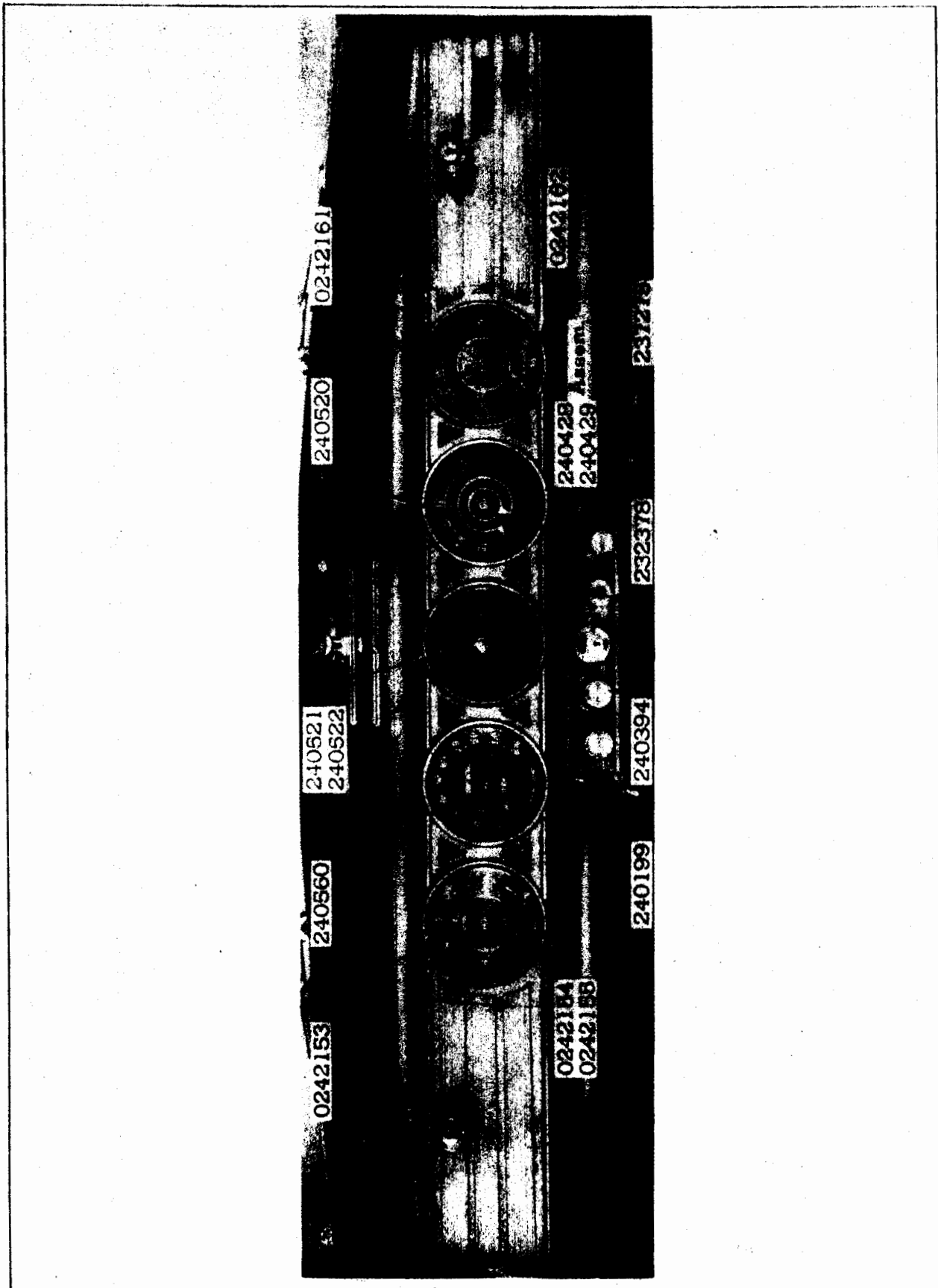

Models 1603-4-5-7-8

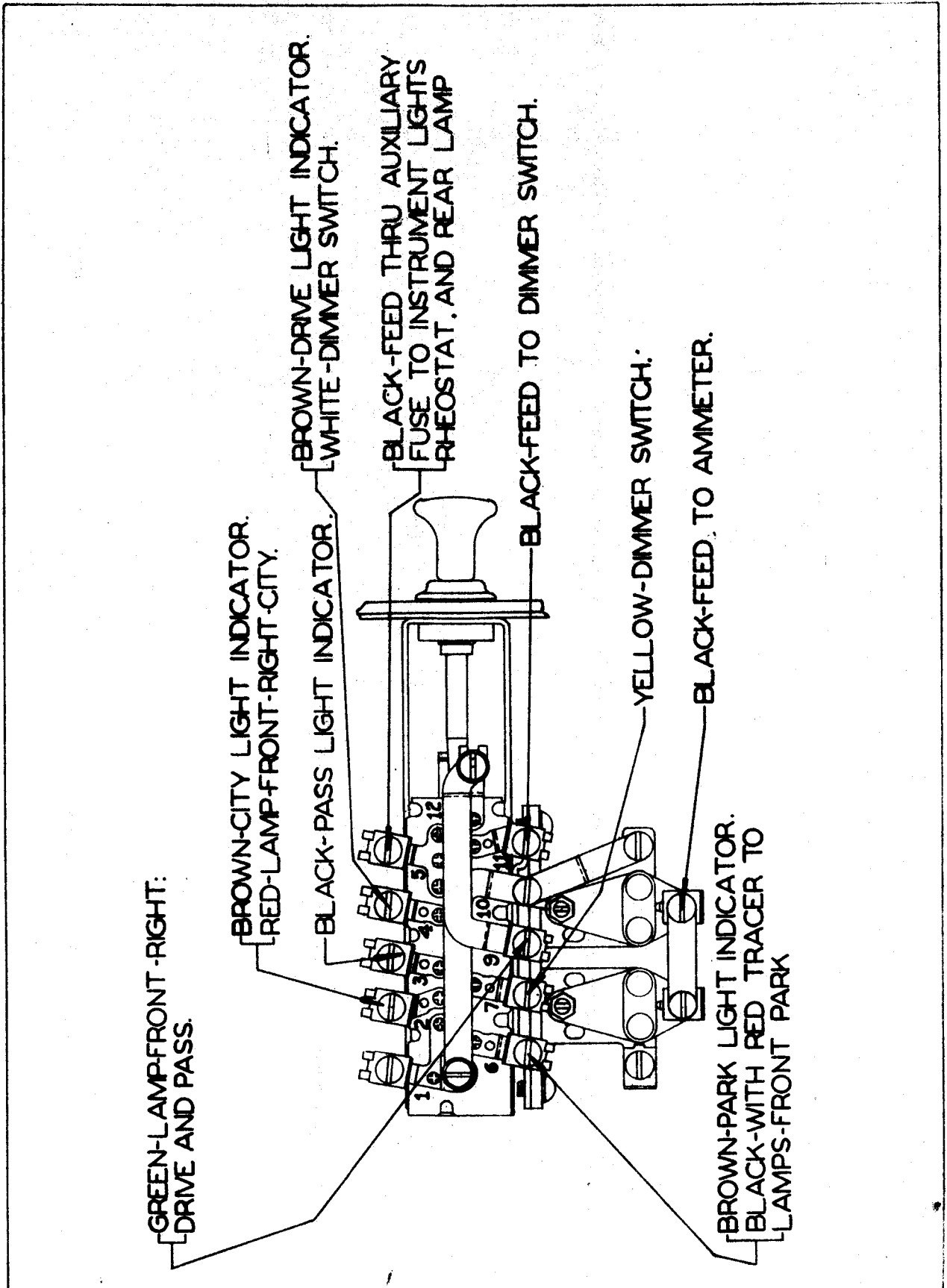

Piece No.	Name	1500	1506	1603	1607	1707	
		1501	1507	1604	1608	1708	
		1502	1508	1605	No. Required		
225264	Instrument board headlight indicator lamp cable socket washer	-	-	1	1	1	
240386	Instrument board headlamp switch assembly	-	-	1	1	1	
240199	Instrument board headlamp switch knob	-	-	1	1	1	
5310	Instrument board instrument panel assembly screw No. 8-32 x 1/4 rnd. hd.	-	-	12	12	12	
6472	Lockwasher No. 8 (Shakeproof)	-	-	12	12	12	
240398	Instrument board instrument panel assembly screw cupwasher	-	-	4	4	4	
240201	Instrument board instrument panel 6 Volt - 1-1/2 C.P.	-	-	1	1	1	
225655	Instrument board instrument panel light bulb (Mazda No. 55) 6 Volt - 1-1/2 C.P.	-	-	6	6	6	
327569	Instrument board instrument panel light bulb 12 Volt - 1 C.P.	-	-	6	-	-	
240642	Instrument board instrument panel light cable assembly	-	-	1	1	1	
316556	Instrument board instrument panel light cable socket	-	-	6	6	6	
225262	Instrument board instrument panel light cable socket contact	-	-	6	6	6	
225263	Instrument board instrument panel light cable socket spring	-	-	6	6	6	
225264	Instrument board instrument panel light cable socket washer	-	-	6	6	6	
242105	Instrument board instrument panel light switch and rheostat assembly (Use with 12 Volt Equipment)	-	-	1	-	-	
240396	Instrument board instrument panel light switch and rheostat assembly (Use with 6 Volt Equipment)	-	-	1	1	1	
5724	Screw No. 8-32 x 3/8 oval hd.	-	-	2	2	2	
0242160	Instrument board instrument panel medallion ...	-	-	1	1	-	
240521	Instrument board instrument panel medallion asb.	-	-	1	-	-	
240522	Instrument board instrument panel medallion asb.	-	-	-	1	-	
242440	Instrument board instrument panel medallion asb.	-	-	-	-	1	
5310	Screw No. 8-32 x 1/4 rnd. hd.	-	-	4	4	4	
6472	Lockwasher 1/4 (Shakeproof)	-	-	4	4	4	
0242163	Instrument board instrument panel medallion case	-	-	1	1	1	
0242164	Instrument board instrument panel medallion dial (false)	-	-	1	1	-	
0242881	Instrument board instrument panel medallion dial (false)	-	-	-	-	1	
0242165	Instrument board instrument panel medallion dial (glass)	-	-	1	-	-	
0242166	Instrument board instrument panel medallion dial (glass)	-	-	-	1	1	
0242168	Instrument board instrument panel medallion dial gasket (false)	-	-	1	1	-	
0242882	Instrument board instrument panel medallion dial gasket (false)	-	-	-	-	1	

SERVICE PARTS LIST--PACKARD SUPER-EIGHT AND TWELVE

Instrument Board 69

Piece No.	Name	1500	1506	1603	1607	1707	
		1501	1507	1604	1608	1708	
		1502	1508	1605	No. Required		
0242167	Instrument board instrument panel medallion face ring	-	-	1	1	1	
0242179	Instrument board instrument panel medallion glass	-	-	1	1	1	
0242180	Instrument board instrument panel medallion glass bezel	-	-	1	1	1	
0242182	Instrument board instrument panel medallion glass bezel gasket	-	-	1	1	1	
0242181	Instrument board instrument panel medallion glass gasket	-	-	1	1	1	
0242162	Instrument board oil gauge	-	-	1	1	-	
0242880	Instrument board oil gauge	-	-	-	-	1	
219164	Instrument board oil pressure gauge tube dash elbow	-	-	1	-	-	
219165	Instrument board oil pressure gauge tube dash elbow	-	-	-	1	1	
7007	Instrument board oil pressure gauge tube dash elbow nut 7/16-20	-	-	1	1	1	
5806	Lockwasher 7/16 (Shakeproof)	-	-	1	1	1	
3883	Plain washer 7/16	-	-	1	1	1	
6722	Connection 1/4 flared tube	-	-	1	-	-	
225250	Connection	-	-	-	1	1	
*225251	Instrument board oil pressure gauge tube lower assembly (Supersedes 232383 and 237935)	-	-	1	-	-	
240557	Instrument board oil pressure gauge tube lower assembly	-	-	-	1	1	
70128	Instrument board oil pressure gauge tube lower assembly clip style No, 4 x 1/4 (R.H. drive)	-	-	1	-	-	
70128	Clip style No. 4 x 1/4	-	-	-	2	2	
194974	Instrument board oil pressure gauge tube lower assembly clip style No. 15 (L.H. drive)	-	-	1	1	1	
5984	Screw No. 6 x 3/8 rnd. hd. (L.H. drive) ..	-	-	1	1	1	
7005	Instrument board oil pressure gauge tube lower assembly clip nut 5/16-24	-	-	-	2	2	
7004	Nut 1/4-28 (R.H. drive)	-	-	1	-	-	
5504	Lockwasher 5/16	-	-	-	2	2	
5502	Lockwasher 1/4 (R.H. drive)	-	-	1	-	-	
225454	Instrument board oil pressure gauge tube lower adapter	-	-	2	2	2	
▲215844	Instrument board oil pressure gauge tube lower adapter	-	-	1	-	-	
216887	Instrument board oil pressure gauge tube lower anti-squeak	-	-	x	x	x	
215546	Instrument board oil pressure gauge tube lower hose assembly	-	-	1	-	-	
157477	Instrument board oil pressure gauge tube lower union nut 1/4 flared tube	-	-	2	2	2	

*When replacing this part on cars without hose, also order 1 each of 215844 adapter and 215546 hose.

▲This part used only with piece No. 225251 oil pressure gauge tube lower and 215546 hose assembly.

Piece No.	Name	1500	1506	1603	1607	1707	
		1501	1507	1604	1608	1708	
		1502	1508	1605	No. Required		
225253	Instrument board oil pressure gauge tube upper assembly (L.H. drive)	-	-	1	1	1	
228676	Instrument board oil pressure gauge tube upper assembly (R.H. drive)	-	-	1	-	-	
225454	Instrument board oil pressure gauge tube upper adapter	-	-	2	2	2	
157477	Instrument board oil pressure gauge tube upper union nut 1/4 flared tube	-	-	2	2	2	
231541	Instrument board to pillar anti-squeak	-	-	4	4	4	
225655	Instrument board reading light bulb Mazda No. 55	-	-	2	2	2	
240459	Instrument board reading light cables and sockets assembly	-	-	1	1	1	
316556	Instrument board reading light cable socket	-	-	2	2	2	
225262	Instrument board reading light cable socket contact	-	-	2	2	2	
225263	Instrument board reading light cable socket spring	-	-	2	2	2	
225264	Instrument board reading light cable socket washer	-	-	2	2	2	
71397	Instrument board reading light cable terminal ..	-	-	1	1	1	
36111	Instrument board reading light cable terminal insulator	-	-	1	1	1	
240619	Instrument board reading light housing and felt assembly--right	-	-	1	1	1	
240620	Instrument board reading light housing and felt assembly--left	-	-	1	1	1	
5724	Instrument board reading light housing screw No. 8-32 x 3/8 oval hd.	-	-	4	4	4	
240483	Instrument board reading light housing sealer felt	-	-	x	x	x	
242225	Instrument board reading light switch assembly ..	-	-	1	1	1	
235701	Instrument board reinforcement ventilator handle support bracket	-	-	1	1	1	
5780	Screw 1/4-28 x 5/8 oval hd.	-	-	1	1	1	
5502	Lockwasher 1/4	-	-	1	1	1	
7004	Nut 1/4-28	-	-	1	1	1	
240560	Instrument board speedometer assembly (Miles per hour)	-	-	1	1	-	
242441	Instrument board speedometer assembly (Miles per hour)	-	-	-	-	1	
240559	Instrument board speedometer assembly (Kilometers per hour)	-	-	1	1	-	
242442	Instrument board speedometer assembly (Kilometers per hour)	-	-	-	-	1	
5310	Screw No. 8-32 x 1/4 rnd. hd.	-	-	4	4	4	
6472	Lockwasher No. 8 (Shakeproof)	-	-	4	4	4	
0242169	Instrument board speedometer case	-	-	1	1	1	
0242170	Instrument board speedometer dial (false)	-	-	1	1	-	
0242883	Instrument board speedometer dial (false)	-	-	-	-	1	
0242172	Instrument board speedometer dial (glass) (Miles per hour)	-	-	1	1	-	

SERVICE PARTS LIST--PACKARD SUPER-EIGHT AND TWELVE

Instrument Board 71

Piece No.	Name	1500	1506	1603	1607	1707	
		1501	1507	1604	1608	1708	
		1502	1508	1605	No. Required		
0242884	Instrument board speedometer dial (glass) (Miles per hour)	-	-	-	-	1	
0242173	Instrument board speedometer dial (glass) (Kilometers)	-	-	1	1	-	
0242887	Instrument board speedometer dial (glass) (Kilometers)	-	-	-	-	1	
0242174	Instrument board speedometer dial (bronze) (Miles per hour)	-	-	1	1	-	
0242886	Instrument board speedometer dial (brass) (Miles per hour)	-	-	-	-	1	
0242175	Instrument board speedometer dial (bronze) (Kilometer)	-	-	1	1	-	
0242168	Instrument board speedometer dial gasket (false)	-	-	1	1	-	
0242882	Instrument board speedometer dial gasket (false)	-	-	-	-	1	
240602	Instrument board speedometer driving shaft.....	-	-	1	1	1	
0242248	Instrument board speedometer driving shaft cable - 75-5/8" long (Used in assembly 74-3/4" long)	-	-	1	1	1	
209851	Instrument board speedometer driving shaft clip	-	-	3	3	3	
5198	Screw No. 10-32 x 5/8 hex. hd.	-	-	1	-	-	
7003	Nut No. 10-32	-	-	1	-	-	
5500	Lockwasher No. 10	-	-	1	-	-	
190231	Instrument board speedometer driving shaft toe board bushing	-	-	1	1	1	
0242167	Instrument board speedometer face ring	-	-	1	1	1	
0242179	Instrument board speedometer glass	-	-	1	1	1	
0242180	Instrument board speedometer glass bezel	-	-	1	1	1	
0242182	Instrument board speedometer glass bezel gasket	-	-	1	1	1	
0242181	Instrument board speedometer glass gasket	-	-	1	1	1	
0242171	Instrument board speedometer pointer	-	-	1	1	-	
0242885	Instrument board speedometer pointer	-	-	-	-	1	
0242176	Instrument board speedometer reset cable asb. .	-	-	1	1	1	
0242178	Instrument board speedometer reset cable	-	-	1	1	1	
0242888	Instrument board speedometer reset knob	-	-	-	-	1	
240394	Instrument board starter switch	-	-	1	1	1	
240393	Instrument board starter switch base	-	-	1	1	1	
240392	Instrument board starter switch button	-	-	1	1	1	
240395	Instrument board starter switch button set screw	-	-	1	1	1	
242252	Instrument board steering post bracket support.	-	-	1	1	1	
6861	Screw 1/4-28 x 7/8 oval hd.	-	-	2	2	2	
5873	Screw 1/4-28 x 9/16 hex. hd.	-	-	2	2	2	
5502	Lockwasher 1/4	-	-	4	4	4	
7004	Nut 1/4-28	-	-	2	2	2	
223714	Instrument board steering post bracket support liner	-	-	2	2	2	
0242154	Instrument board temperature gauge	-	-	1	-	-	
0242155	Instrument board temperature gauge	-	-	-	1	-	
0242876	Instrument board temperature gauge	-	-	-	-	1	
237275	Instrument board throttle control knob and cable assembly	-	-	1	1	1	
237295	Lock nut 7/16-20 special	-	-	1	1	1	
5728	Lockwasher 7/16	-	-	1	1	1	

Piece No.	Name	1500	1506	1603	1607	1707	
		1501	1507	1604	1608	1708	
		1502	1508	1605	No. Required		
LAMP (Specify Color)							
225598	Lamp bulb kit	2	2	-	-	-	
218823	Lamp courtesy assembly	-	2	-	-	-	
181221	Lamp courtesy conduit	-	2	-	-	-	
102590	Lamp courtesy bulb	-	2	-	-	-	
226595	Lamp courtesy to fender gasket	-	2	-	-	-	
0185064	Lamp courtesy glass and rim	-	2	-	-	-	
0226583	Lamp courtesy glass and rim screw	-	8	-	-	-	
0218824	Lamp courtesy-socket assembly	-	2	-	-	-	
220761	Lamp courtesy-switch	-	2	-	-	-	
232240	Lamp front assembly--right (Specify color)	1	1	-	-	-	
232253	Lamp front assembly--right (Chromium)	1	1	-	-	-	
232241	Lamp front assembly--left (Specify color)	1	1	-	-	-	
232254	Lamp front assembly--left (Chromium)	1	1	-	-	-	
232242	Lamp front bracket--left (Specify color)	1	1	-	-	-	
232243	Lamp front bracket--right (Specify color)	1	1	-	-	-	
232244	Lamp front bracket to fender gasket--left	1	1	-	-	-	
232245	Lamp front bracket to fender gasket--right	1	1	-	-	-	
225659	Lamp front to bracket grommet	2	2	-	-	-	
304308	Lamp front to bracket grommet screw No. 10 x 1/2 binding head (Parker-Kalon)	6	6	-	-	-	
225149	Lamp front bracket stud--long	2	2	-	-	-	
225706	Lamp front bracket stud--short	2	2	-	-	-	
3884	Washer plain 1/2"	6	6	-	-	-	
6047	Lockwasher 1/2" (Shakeproof)	6	6	-	-	-	
7008	Nut 1/2-20	4	4	-	-	-	
228548	Lamp front bracket screw 1/2-13 x 3/4" hex. hd.	2	2	-	-	-	
223978	Lamp front bulb--right	1	1	-	-	-	
232252	Lamp front bulb--left	1	1	-	-	-	
0225878	Lamp front door fastening screw	2	2	-	-	-	
0239017	Lamp front door fastening screw bracket	2	2	-	-	-	
0225866	Lamp front door and glass assembly--right	1	1	-	-	-	
0225867	Lamp front door and glass assembly--left	1	1	-	-	-	
0225868	Lamp front door glass--right	1	1	-	-	-	
0225869	Lamp front door glass--left	1	1	-	-	-	
0225870	Lamp front door glass retainer	2	2	-	-	-	
170945	Lamp front gasket	2	2	-	-	-	
237435	Lamp front moulding	2	2	-	-	-	
225958	Lamp front mounting stud nut 1/2-13	2	2	-	-	-	
232246	Lamp front mounting spacer	2	2	-	-	-	
239040	Lamp front mounting spacer washer (Supersedes 158669)	2	2	-	-	-	
5510	Lockwasher	2	2	-	-	-	
225655	Lamp front parking bulb (Mazda No. 55 - 1-1/2 C.P.)	2	2	-	-	-	
0239082	Lamp front reflector assembly	2	2	-	-	-	
0225873	Lamp front reflector gasket	2	2	-	-	-	
0239083	Lamp front sockets and cables--right	1	1	-	-	-	
0239084	Lamp front sockets and cables--left	1	1	-	-	-	

SERVICE PARTS LIST--PACKARD SUPER-EIGHT AND TWELVE

Lamp 73

Piece No.	Name	1500	1506	1603	1607	1707	
		1501	1507	1604	1608	1708	
		1502	1508	1605	No. Required		
237394	Lamp rear and bracket right assembly (Use with bodies 1007-17-18-19-27-37-38-39) (Specify color)	1	1	-	-	-	
237112	Lamp rear and bracket right assembly (Use with bodies 1016-26) (Specify color) (L.H. drive).	1	1	-	-	-	
237393	Lamp rear and bracket left assembly (Use with bodies 1007-17-18-19-27-37-28-39) (Specify color)	1	1	-	-	-	
237111	Lamp rear and bracket left assembly (Use with bodies 1016-36) (Specify color) (L.H. drive).	1	1	-	-	-	
232256	Lamp rear and bracket assembly--right (Use with bodies 1003-12-13-14-15-23-32-33-34-35-63-73-L394-L395) (Specify color) (L.H. drive)	1	1	-	-	-	
232250	Lamp rear and bracket assembly--left (Use with bodies 1003-12-13-14-15-23-32-33-34-35-63-73-L394-L395) (Specify color) (L.H. drive)	1	1	-	-	-	
237396	Lamp rear and bracket right assembly (Use with bodies 1007-17-18-19-27-37-38-39) (Chromium)	1	1	-	-	-	
237395	Lamp rear and bracket left assembly (Use with bodies 1007-17-18-19-27-37-38-39) (Chromium)	1	1	-	-	-	
232260	Lamp rear and bracket assembly--left (Use with bodies 1003-12-13-14-15-23-32-33-34-35-63-73-L394-L395) (Chromium) (L.H. drive)	1	1	-	-	-	
232259	Lamp rear and bracket assembly--right (Use with bodies 1003-12-13-14-15-23-32-33-34-35-63-73-L394-L395) (Chromium) (L.H. drive) .	1	1	-	-	-	
237113	Lamp rear and bracket assembly--left (Chromium) (Use with bodies 1016-36) (L.H. drive)	1	1	-	-	-	
237114	Lamp rear and bracket assembly--right (Chromium) (Use with bodies 1016-36) (L.H. drive)	1	1	-	-	-	
237300	Lamp rear and bracket assembly--right (Specify color) (Used on body 1016) (R.H. drive)	1	-	-	-	-	
237301	Lamp rear and bracket assembly--right (Chromium) (Used on body 1016) (R.H. drive)	1	-	-	-	-	
237245	Lamp rear and bracket assembly--left (Specify color) (Used on body 1016) (R.H. drive)	1	-	-	-	-	
237346	Lamp rear and bracket assembly--left (Chromium) (Used on body 1016) (R.H. drive)	1	-	-	-	-	
237302	Lamp rear and bracket assembly--right (Specify color) (Used on bodies 1003-12-13-14-15-63) (R.H. drive)	1	-	-	-	-	
237303	Lamp rear and bracket assembly--right (Chromium) (Used on bodies 1003-12-13-14-15-63) (R.H. drive)	1	-	-	-	-	
237247	Lamp rear and bracket assembly--left (Specify color) (Used on bodies 1003-12-13-14-15-63) (R.H. drive)	1	-	-	-	-	

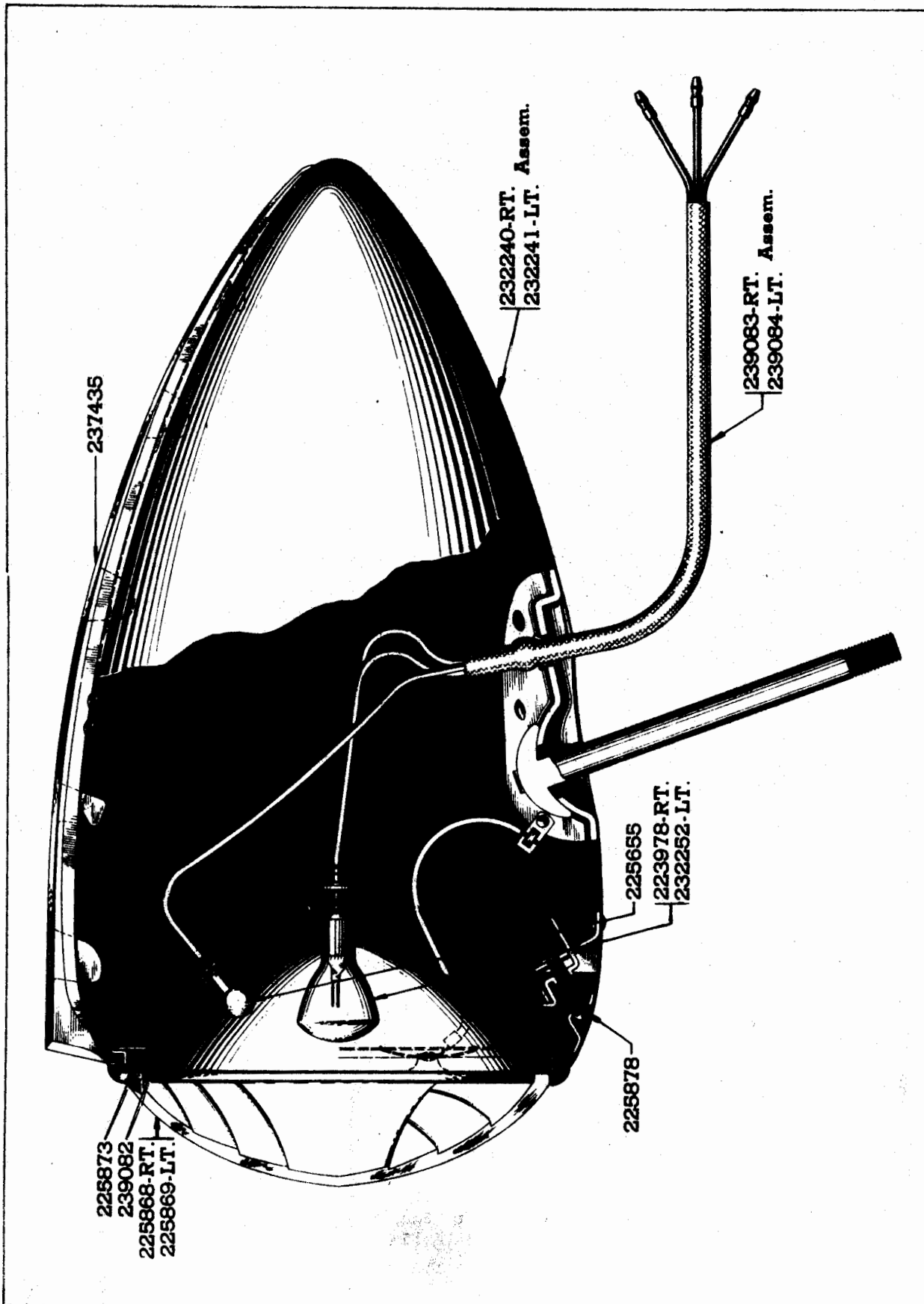

SERVICE PARTS LIST--PACKARD SUPER-EIGHT AND TWELVE

Lamp 75

Piece No.	Name	1500	1506	1603	1607	1707	
		1501	1507	1604	1608	1708	
		1502	1508	1605	No. Required		
237348	Lamp rear and bracket assembly--left (Chromium) (Used on bodies 1003-12-13-14-15-63) (R.H. drive)	1	-	-	-	-	
232251	Lamp rear and bracket assembly gasket (Use with bodies 1003-12-13-14-15-16-23-32-33-34-35-36-63-73-L394-L395)	2	2	-	-	-	
303646	Lamp rear body--left (Use with bodies 1003-12-13-14-15-16-23-32-33-34-35-36-63-73-L394-L395) (L.H. drive)	1	1	-	-	-	
303647	Lamp rear body--right (Use with bodies 1003-12-13-14-15-16-23-32-33-34-35-36-63-73-L394-L395) (L.H. drive)	1	1	-	-	-	
303644	Lamp rear body--left (Specify color) (Used on bodies 1007-17-18-19-27-37-38-39)	1	1	-	-	-	
303645	Lamp rear body--right (Specify color) (Used on bodies 1007-17-18-19-27-37-38-39)	1	1	-	-	-	
304135	Lamp rear body--right (Specify color) (Used on bodies 1003-12-13-14-15-16-1063) (R.H. drive)	1	-	-	-	-	
304133	Lamp rear body--left (Specify color) (Used on bodies 1003-12-13-14-15-16-1063) (R.H. drive)	1	-	-	-	-	
237429	Lamp rear bracket (Specify color) (Used on bodies 1007-17-18-19-27-37-38-39)	2	2	-	-	-	
237110	Lamp rear bracket--right (Specify color) (Used on bodies 1016-36)	1	1	-	-	-	
237109	Lamp rear bracket--left (Specify color) (Used on bodies 1016-36)	1	1	-	-	-	
✓ 232258	Lamp rear bracket--right (Specify color) (Used on bodies 1003-12-13-14-15-23-32-33-34-35-63-73-L394-L395)	1	1	-	-	-	
✓ 232248	Lamp rear bracket--left (Specify color) (Used on bodies 1003-12-13-14-15-23-32-33-34-35-63-73-L394-L395)	1	1	-	-	-	
223577	Lamp rear bracket gasket (Use with bodies 1007-17-18-19-27-37-38-39)	2	2	-	-	-	
201768	Lamp rear bracket license tag plate (Specify color)	1	1	-	-	-	
186330	Lamp rear bracket license tag plate (Chromium).	1	1	-	-	-	
190332	Lamp rear bracket license tag plate clamp screw (Chromium)	1	1	-	-	-	
5277	Clamp screw 1/4-20 x 3/4 flat hd. (Specify color)	1	1	-	-	-	
5502	Lockwasher 1/4 (Use with Chrome screw) ...	1	1	-	-	-	
5899	Lockwasher 5/16 countersunk (Shakeproof) special (Specify color)	1	1	-	-	-	
190091	Nut (Use with Chrome screw)	1	1	-	-	-	
307458	Lamp rear bracket license tag plate clamp screw spacer (Specify color)	1	1	-	-	-	
225632	Lamp rear bracket license tag plate clip (Specify color)	1	1	-	-	-	
190092	Lamp rear bracket license tag plate clip (Chromium)	1	1	-	-	-	

Piece No.	Name	1500	1506	1603	1607	1707
		1501	1507	1604	1608	1708
		1502	1508	1605	No. Required	
5928	Screw 1/4-20 x 5/8 fill. hd. (Specify color)	1	1	-	-	-
5898	Screw 1/4-20 x 9/16 rnd. hd.	1	1	-	-	-
5502	Lockwasher 1/4 standard (Specify color) ..	1	1	-	-	-
0303435	Lamp rear bracket reinforcement	2	2	-	-	-
3729	Screw	2	2	-	-	-
5500	Lockwasher	4	4	-	-	-
6185	Screw	2	2	-	-	-
6044	Lockwasher 5/16 (Shakeproof)	2	2	-	-	-
7709	Lamp rear bracket screw	2	2	-	-	-
6061	Lamp rear bracket retaining screw 5/16-18 x 7/8 hex. hd.	4	4	-	-	-
6044	Lockwasher 5/16 (Shakeproof)	4	4	-	-	-
6359	Washer plain 5/16	4	4	-	-	-
203301	Lamp rear bulb (stoplight)	2	2	-	-	-
102590	Lamp rear bulb (tail light)	2	2	-	-	-
5696	Lamp rear bulb retainer screw	4	4	-	-	-
3774	Lockwasher	4	4	-	-	-
0239063	Lamp rear cable assembly--left	1	1	-	-	-
0239064	Lamp rear cable assembly--right	1	1	-	-	-
0239065	Lamp rear door and glass assembly	2	2	-	-	-
5325	Lamp rear door fastening screw	2	2	-	-	-
0239066	Lamp rear door glass assembly	2	2	-	-	-
0311715	Lamp rear door glass gasket	2	2	-	-	-
0225881	Lamp rear door glass jewel	2	2	-	-	-
303641	Lamp rear license bracket	1	1	-	-	-
0303437	Lamp rear license tag bracket (Specify color) .	1	1	-	-	-
0239067	Lamp rear license tag bracket (Chromium)	1	1	-	-	-
6185	Screw	2	2	-	-	-
6044	Lockwasher	2	2	-	-	-
0303443	Lamp rear license tag bracket plate	1	1	-	-	-
0303439	Lamp rear license glass	1	1	-	-	-
0303442	Lamp rear license glass gasket	1	1	-	-	-
0194453	Lamp rear license glass retainer	1	1	-	-	-
070296	Lamp rear license glass retainer screw No. 6-32 x 3/8	2	2	-	-	-

LAMPS

327587	Lamp bulb case	-	-	2	2	2
218823	Lamp courtesy assembly	-	-	-	2	2
102590	Lamp courtesy bulb - 3 C.P.	-	-	-	2	2
181221	Lamp courtesy conduit	-	-	-	2	2
226595	Lamp courtesy to fender gasket	-	-	-	2	2
0185064	Lamp courtesy glass and rim	-	-	-	2	2
0226583	Lamp courtesy glass and rim screw	-	-	-	8	8
0218824	Lamp courtesy socket assembly	-	-	-	2	2
220761	Lamp courtesy switch	-	-	-	2	2
240420	Lamp (front) assembly--right (L.H. drive) (Specify color) (6 Volt - 32-32 C.P.)	-	-	1	1	1

SERVICE PARTS LIST--PACKARD SUPER-EIGHT AND TWELVE

Lamps 77

Piece No.	Name	1500	1506	1603	1607	1707
		1501	1507	1604	1608	1708
		1502	1508	1605	No. Required	
242051	Lamp (front) assembly--right (R.H. drive) (Specify color) (6 Volt - 32-21 C.P.)	-	-	1	-	-
240421	Lamp (front) assembly--left (6 Volt- 32-21 C.P.)	-	-	1	1	1
240446	Lamp (front) assembly--right (L.H. drive) (Chromium) (6 Volt - 32-32 C.P.)	-	-	1	1	1
242052	Lamp (front) assembly--right (R.H. drive) (Chromium) (6 Volt - 32-21 C.P.)	-	-	1	-	-
240447	Lamp (front) assembly--left (Chromium) (6 Volt - 32-21 C.P.)	-	-	1	1	1
242081	Lamp (front) assembly--right (R.H. drive) (Specify color) (12 Volt - 50-50 C.P.)	-	-	1	-	-
242082	Lamp (front) assembly--left (R.H. drive) (Specify color) (12 Volt - 50-50 C.P.)	-	-	1	-	-
242083	Lamp (front) assembly--right (R.H. drive) (Chromium) (12 Volt - 50-50 C.P.)	-	-	1	-	-
242084	Lamp (front) assembly--left (R.H. drive) (Chromium) (12 Volt - 50-50 C.P.)	-	-	1	-	-
240422	Lamp (front) body assembly--right (Specify color)	-	-	1	1	1
240423	Lamp (front) body assembly--left (Specify color)	-	-	1	1	1
240448	Lamp (front) body assembly--right (Chromium) ..	-	-	1	1	1
240449	Lamp (front) body assembly--left (Chromium) ...	-	-	1	1	1
232252	Lamp (front) bulb--left (for driving lights) (6 Volt - 32-21 C.P.) (L.H. drive)	-	-	1	1	1
223978	Lamp (front) bulb--right (for driving lights) (6 Volt - 32-32 C.P.) (L.H. drive)	-	-	1	1	1
232252	Lamp (front) bulb (for driving lights) (6 Volt - 32-21 C.P.) (R.H. drive)	-	-	2	-	-
225655	Lamp (front) bulb (for parking lights) (6 Volt - 1-1/2 C.P.)	-	-	2	2	2
330566	Lamp (front) bulb (for driving lights) (12 Volt - 50-50 C.P.) (R.H. drive)	-	-	2	-	-
327569	Lamp (front) bulb (for parking lights) (12 Volt - 1-1/2 C.P.) (R.H. drive)	-	-	2	-	-
0326897	Lamp (front) bulb retainer (for driving lights)	-	-	2	2	2
0239561	Lamp (front) bulb retainer (for parking lights)	-	-	2	2	2
0239559	Lamp (front) cable assembly--right	-	-	1	1	1
0239602	Lamp (front) cable assembly--left	-	-	1	1	1
0225878	Lamp (front) door fastening screw	-	-	2	2	2
0225866	Lamp (front) door and glass assembly--right ...	-	-	1	1	1
0225867	Lamp (front) door and glass assembly--left	-	-	1	1	1
0225868	Lamp (front) door glass--right	-	-	1	1	1
0225869	Lamp (front) door glass--left	-	-	1	1	1
0225870	Lamp (front) door glass retainer	-	-	2	2	2
0239557	Lamp (front) door shell assembly	-	-	2	2	2
0239558	Lamp (front) ground cable assembly	-	-	2	2	2
237435	Lamp (front) moulding	-	-	2	2	2
240329	Lamp (front) mounting bolt clamp	-	-	2	2	2
242199	Lamp (front) mounting bolt nut	-	-	2	2	2
5518	Lockwasher 3/4	-	-	2	2	2
0239082	Lamp (front) reflector assembly	-	-	2	2	2
0225873	Lamp (front) reflector gasket	-	-	2	2	2
324442	Lamp (front) seat	-	-	2	2	2

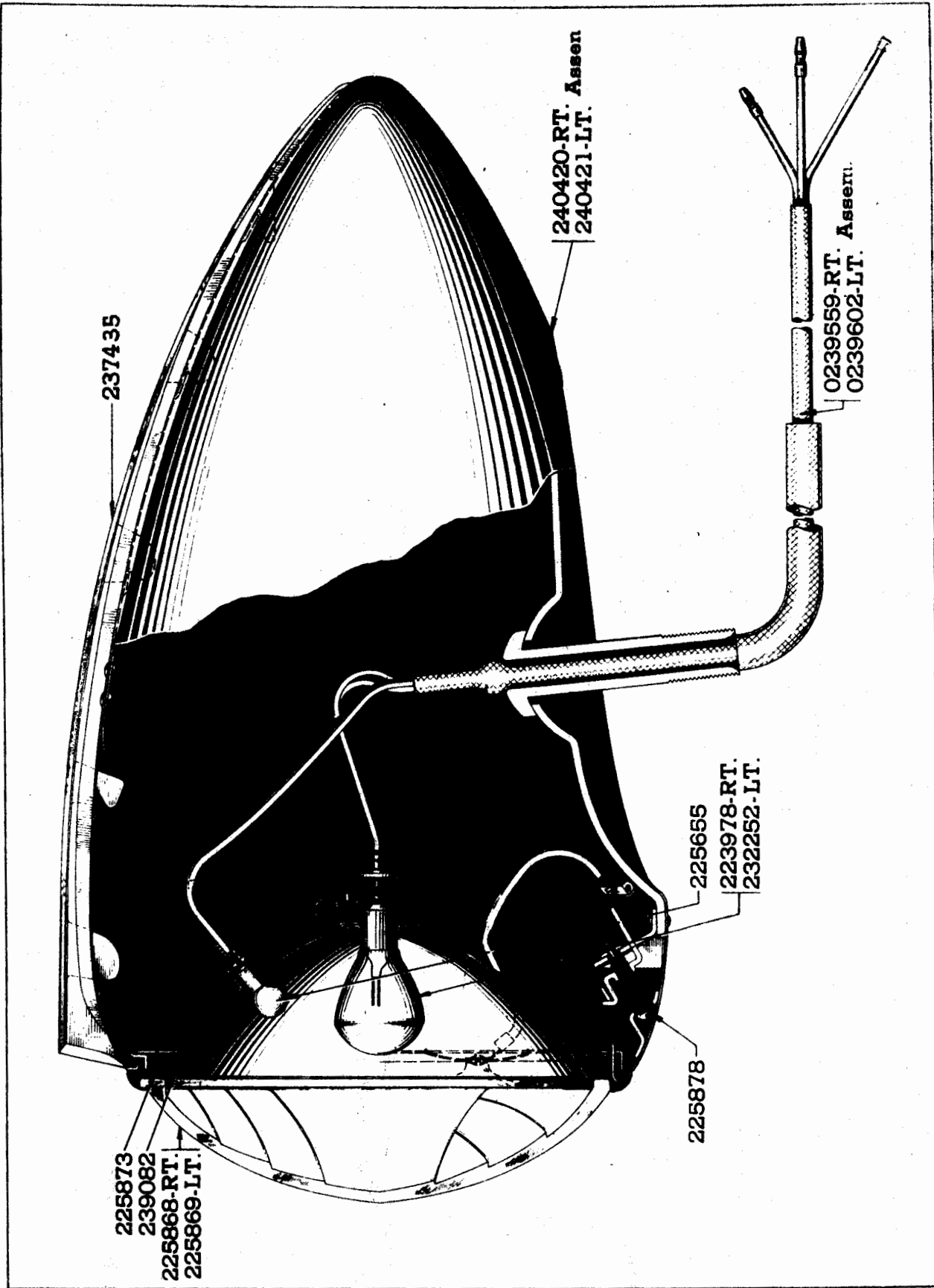

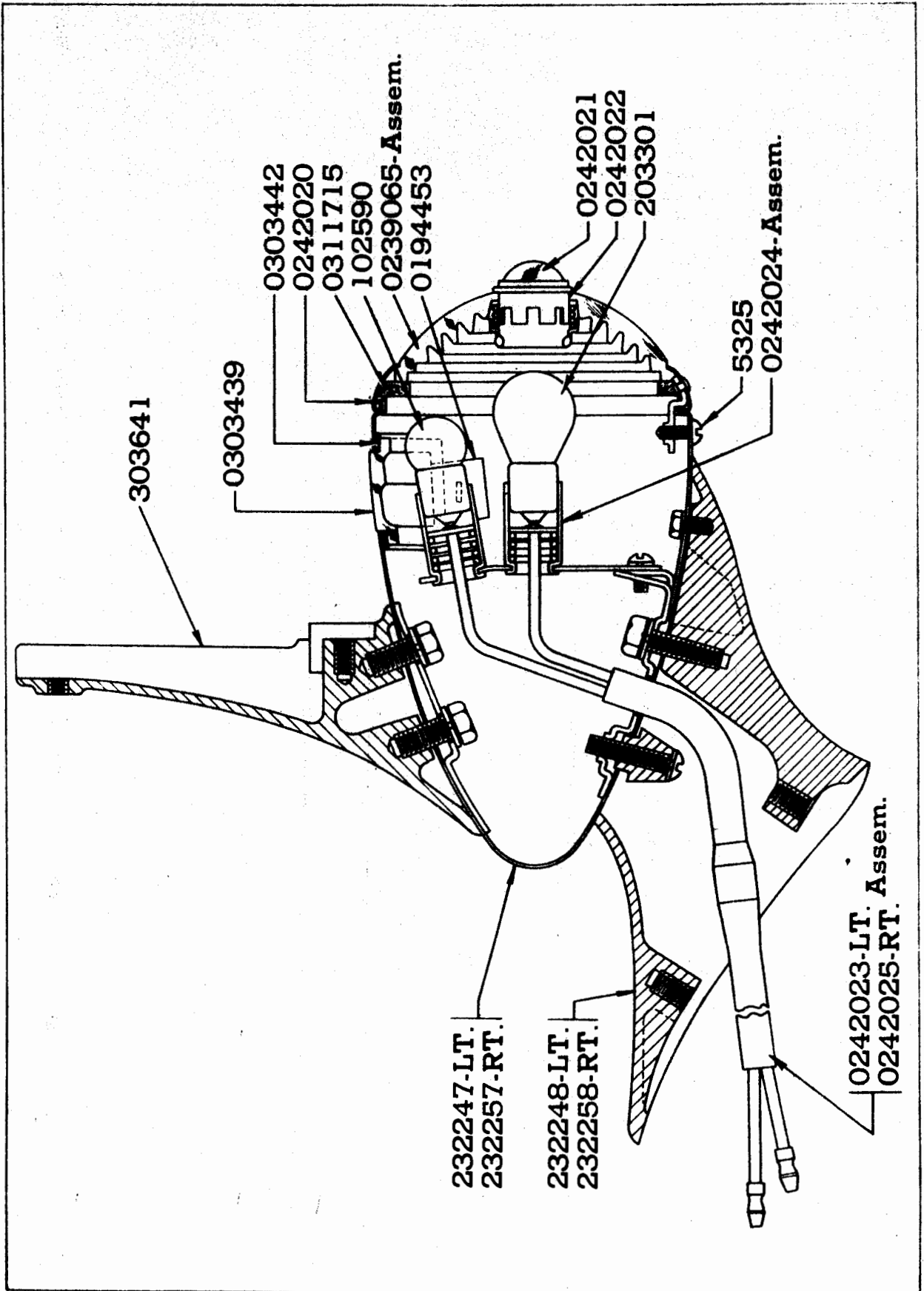

80 Lamps

SERVICE PARTS LIST--PACKARD SUPER-EIGHT AND TWELVE

Piece No.	Name	1500	1506	1603	1607	1707	
		1501	1507	1604	1608	1708	
		1502	1508	1605	No. Required		
324444	Lamp (front) seat gasket	-	-	4	4	4	
232256	Lamp rear and bracket assembly--right (Specify color) (L.H. drive) (6 Volt) (Used with bodies 1103-12-13-14-15-32-33-34-35-43-53-1232-33-34-35-53)	-	-	1	1	1	
232250	Lamp (rear) and bracket assembly--left (Specify color) (L.H. drive) (6 Volt) (Used with bodies 1103-12-13-14-15-32-33-34-35-43-53-1232-33-34-35-53)	-	-	1	1	1	
237302	Lamp (rear) and bracket assembly--right (Specify color) (R.H. drive) (6 Volt) (Used with bodies 1103-12-13-14-15-43)	-	-	1	-	-	
237247	Lamp (rear) and bracket assembly--left (Specify color) (R.H. drive) (6 Volt) (Used with bodies 1103-12-13-14-15-43)	-	-	1	-	-	
237112	Lamp (rear) and bracket assembly--right (Specify color) (L.H. drive) (6 Volt) (Use with bodies 1116-36-1236)	-	-	1	1	1	
237111	Lamp (rear) and bracket assembly--left (Specify color) (L.H. drive) (6 Volt) (Used with bodies 1116-36-1236)	-	-	1	1	1	
237245	Lamp (rear) and bracket assembly--left (Specify color) (R.H. drive) (6 Volt) (Used with body 1116)	-	-	1	-	-	
237300	Lamp (rear) and bracket assembly--right (Specify color) (R.H. drive) (6 Volt) (Used with body 1116)	-	-	1	-	-	
237394	Lamp (rear) and bracket assembly--right (Specify color) (6 Volt) (Used with bodies 1107-17-18-19-27-37-38-39-1237-38-39-27)	-	-	1	1	1	
237393	Lamp (rear) and bracket assembly--left (Specify color) (6 Volt) (Used with bodies 1107-17-18-19-27-37-38-39-1227-37-38-39)	-	-	1	1	1	
237396	Lamp (rear) and bracket assembly--right (Chromium) (6 Volt) (Use with bodies 1107-17-18-19-27-37-38-39-1227-37-38-39)	-	-	1	1	1	
237395	Lamp (rear) and bracket assembly--left (Chromium) (6 Volt) (Use with bodies 1107-17-18-19-27-37-38-39-1227-37-38-39)	-	-	1	1	1	
232260	Lamp (rear) and bracket assembly--left (Chromium) (L.H. drive) (6 Volt) (Use with bodies 1103-12-13-14-15-32-33-34-35-43-53-1232-33-34-35-53)	-	-	1	1	1	
232259	Lamp (rear) and bracket assembly--right (Chromium) (L.H. drive) (6 Volt) (Use with bodies 1103-12-13-14-15-32-33-34-35-43-53-1232-33-34-35-53)	-	-	1	1	1	
237348	Lamp (rear) and bracket assembly--left (Chromium) (R.H. drive) (6 Volt) (Use with bodies 1103-12-13-14-15-43)	-	-	1	-	-	

SERVICE PARTS LIST--PACKARD SUPER-EIGHT AND TWELVE

Lamps 81

Piece No.	Name	1500	1506	1603	1607	1707
		1501	1507	1604	1608	1708
		1502	1508	1605	No. Required	
237303	Lamp (rear) and bracket assembly--right (Chromium) (R.H. drive) (6 Volt) (Use with bodies 1103-12-13-14-15-1143)	-	-	1	-	-
237113	Lamp (rear) and bracket assembly--left (Chromium) (L.H. drive) (6 Volt) (Use with bodies 1116-32-1236)	-	-	1	1	1
237114	Lamp (rear) and bracket assembly--right (Chromium) (L.H. drive) (6 Volt) (Use with bodies 1116-36-1236)	-	-	1	1	1
237346	Lamp (rear) and bracket assembly--left (Chromium) (R.H. drive) (6 Volt) (Use with body 1116)	-	-	1	-	-
237301	Lamp (rear) and bracket assembly--right (Chromium) (R.H. drive) (6 Volt) (Use with body 1116)	-	-	1	-	-
242101	Lamp (rear) and bracket assembly--right (Specify color) (R.H. drive) (12 Volt) (Use with bodies 1103-12-13-14-15-1143)	-	-	1	-	-
242100	Lamp (rear) and bracket assembly--left (Specify color) (R.H. drive) (12 Volt) (Use with bodies 1103-12-13-14-15-1143)	-	-	1	-	-
242096	Lamp (rear) and bracket assembly--left (Specify color) (R.H. drive) (12 Volt) (Use with body 1116)	-	-	1	-	-
242097	Lamp (rear) and bracket assembly--right (Specify color) (R.H. drive) (12 Volt) (Use with body 1116)	-	-	1	-	-
242099	Lamp (rear) and bracket assembly--right (Specify color) (R.H. drive) (12 Volt) (Use with bodies 1107-17-18-19)	-	-	1	-	-
242098	Lamp (rear) and bracket assembly--left (Specify color) (R.H. drive) (12 Volt) (Use with bodies 1107-17-18-19)	-	-	1	-	-
242095	Lamp (rear) and bracket assembly--right (Chromium) (R.H. drive) (12 Volt) (Use with bodies 1107-17-18-19)	-	-	1	-	-
242094	Lamp (rear) and bracket assembly--left (Chromium) (R.H. drive) (12 Volt) (Use with bodies 1107-17-18-19)	-	-	1	-	-
242111	Lamp (rear) and bracket assembly--left (Chromium) (R.H. drive) (12 Volt) (Use with bodies 1103-12-13-14-15-1143)	-	-	1	-	-
242110	Lamp (rear) and bracket assembly--right (Chromium) (R.H. drive) (12 Volt) (Use with bodies 1103-12-13-14-15-1143)	-	-	1	-	-
242113	Lamp (rear) and bracket assembly--left (Chromium) (R.H. drive) (12 Volt) (Use with body 1116)	-	-	1	-	-
242112	Lamp (rear) and bracket assembly--right (Chromium) (R.H. drive) (12 Volt) (Use with body 1116)	-	-	1	-	-

Piece No.	Name	1500	1506	1603	1607	1707	
		1501	1507	1604	1608	1708	
		1502	1508	1605	No. Required		
232251	Lamp (rear) and bracket assembly gasket (Use with bodies 1103-12-13-14-15-16-32-33-34-35-36-1143-53-1232-33-34-35-53-36)	-	-	1	1	1	
232257	Lamp (rear) body--right (Specify color) (L.H. drive) (Use with bodies 1103-12-13-14-15-16-1132-33-34-35-36-1143-53-1232-33-34-35-36-53)	-	-	1	1	1	
232247	Lamp (rear) body--left (Specify color) (Use with bodies 1103-12-13-14-15-16-32-33-34-35-36-1143-53-1232-33-34-35-36-53)	-	-	1	1	1	
237304	Lamp (rear) body--right (Specify color) (R.H. drive) (Use with bodies 1103-12-13-14-15-16-1143)	-	-	1	-	-	
237347	Lamp (rear) body--left (Specify color) (R.H. drive) (Use with bodies 1103-12-13-14-15-16-1143)	-	-	1	-	-	
232258	Lamp (rear) bracket--right (Specify color) (Use with bodies 1103-12-13-14-15-1132-33-34-35-1143-53-1232-33-34-35-53)	-	-	1	1	1	
237110	Lamp (rear) bracket--right (Specify color) (Use with bodies 1116-36-1236)	-	-	1	1	1	
232248	Lamp (rear) bracket--left (Specify color) (Use with bodies 1103-12-13-14-15-1132-33-34-35-1143-53-1232-33-34-35-53)	-	-	1	1	1	
237109	Lamp (rear) bracket--left (Specify color) (Use with bodies 1116-36-1236)	-	-	1	1	1	
237429	Lamp (rear) bracket (Use with bodies 1107-17-18-19-27-37-38-39-1227-37-38-39)	-	-	2	2	2	
223577	Lamp (rear) bracket gasket (Use with bodies 1107-17-18-19-27-37-38-39-1227-37-38-39) ...	-	-	2	2	2	
201768	Lamp (rear) bracket license tag plate (Specify color)	-	-	1	1	1	
186330	Lamp (rear) bracket license tag plate (Chromium)	-	-	1	1	1	
190332	Lamp (rear) bracket license tag plate clamp screw (Chromium)	-	-	1	1	1	
5277	Screw 1/4-20 x 3/4 flat hd. (Specify color)	-	-	1	1	1	
5502	Lockwasher 1/4 (Use with Chrome screw) ...	-	-	1	1	1	
5899	Lockwasher 5/16 countersunk (Shakeproof) (Specify color)	-	-	1	1	1	
190091	Nut (Use with Chrome screw)	-	-	1	1	1	
307458	Lamp (rear) bracket license tag plate clamp screw spacer (Specify color)	-	-	1	1	1	
225632	Lamp (rear) bracket license tag plate clip (Specify color)	-	-	1	1	1	
190092	Lamp (rear) bracket license tag plate clip (Chrome)	-	-	1	1	1	
5928	Screw 1/4-20 x 5/8 fill. hd. (Specify color)	-	-	1	1	1	
5898	Screw 1/4-20 x 9/16 rnd. hd.	-	-	1	1	1	
5502	Lockwasher 1/4	-	-	1	1	1	
0303435	Lamp (rear) bracket reinforcement	-	-	2	2	2	
3729	Screw	-	-	2	2	2	
5500	Lockwasher	-	-	4	4	4	

SERVICE PARTS LIST--PACKARD SUPER-EIGHT AND TWELVE

License Plate 83

Piece No.	Name	1500	1506	1603	1607	1707	
		1501	1507	1604	1608	1708	
		1502	1508	1605	No. Required		
6185	Screw	-	-	2	2	2	
6044	Lockwasher 5/16 (Shakeproof)	-	-	2	2	2	
7709	Lamp (rear) bracket screw	-	-	2	2	2	
6061	Lamp (rear) bracket retaining screw 5/16-18 x 7/8 hex. hd. (Use with bodies 1107-17-18-19-27-37-38-39-1227-37-38-39)	-	-	4	4	4	
7857	Lamp (rear) bracket screw 5/16-18 x 1 hex. hd. (Use with bodies 1103-12-13-14-15-16-32-33-34-35-36-1143-53-1232-33-34-35-36-53)	-	-	4	4	4	
6044	Lockwasher 5/16 (Shakeproof)	-	-	4	4	4	
6359	Washer plain 5/16	-	-	4	4	4	
203301	Lamp (rear) bulb (stoplight) (6 Volt - 15 C.P.)	-	-	2	2	2	
102590	Lamp (rear) bulb (tail lamp) (6 Volt - 3 C.P.)	-	-	2	2	2	
327567	Lamp (rear) bulb (stoplight) (R.H. drive) (12 Volt - 15 C.P.)	-	-	2	-	-	
327565	Lamp (rear) bulb (tail lamp) (R.H. drive) (12 Volt 3 C.P.)	-	-	2	-	-	
0303528	Lamp (rear) bulb retainer assembly (Supersedes 0242024)	-	-	2	2	2	
5696	Screw	-	-	4	4	4	
3774	Lockwasher	-	-	4	4	4	
0242023	Lamp (rear) cable assembly--left (L.H. drive)	-	-	2	2	2	
0242025	Lamp (rear) cable assembly--right (L.H. drive)	-	-	2	2	2	
0242023	Lamp (rear) cable assembly--right (R.H. drive)	-	-	2	-	-	
0242025	Lamp (rear) cable assembly--left (R.H. drive)	-	-	2	-	-	
0239065	Lamp (rear) door and glass assembly	-	-	2	2	2	
5325	Lamp (rear) door fastening screw	-	-	2	2	2	
0239066	Lamp (rear) door glass assembly	-	-	2	2	2	
0311715	Lamp (rear) door glass gasket	-	-	2	2	2	
0242021	Lamp (rear) door glass jewel	-	-	2	2	2	
0242022	Lamp (rear) door glass jewel retainer	-	-	2	2	2	
0242020	Lamp (rear) door shell assembly	-	-	2	2	2	
303641	Lamp (rear) license bracket (L.H. drive)	-	-	1	1	1	
0303437	Lamp (rear) license tag bracket (Specify color)	-	-	1	1	1	
0239067	Lamp (rear) license tag bracket (Chromium)	-	-	1	1	1	
6185	Screw	-	-	2	2	2	
6044	Lockwasher	-	-	2	2	2	
0303443	Lamp (rear) license tag bracket plate	-	-	1	1	1	
0303439	Lamp (rear) license glass	-	-	1	1	1	
0303442	Lamp (rear) license glass gasket	-	-	1	1	1	
0194453	Lamp rear license glass retainer	-	-	1	1	1	
070296	Screw No. 6-32 x 3/8	-	-	2	2	2	

LICENSE PLATE

311678	License plate front bracket and tag plate assembly (Specify color)	1	1	1	1	1
--------	--	---	---	---	---	---

Piece No.	Name	1500	1506	1603	1607	1707	
		1501	1507	1604	1608	1708	
		1502	1508	1605	No. Required		
LOCK KEY							
182478	Lock key (Use for ignition and front and rear door locks)	2	2	2	2	2	
237902	Lock key case	1	1	-	-	-	
242053	Lock key case	-	-	1	1	1	
MOTOR CAMSHAFT							
215646	Motor camshaft	1	-	1	-	-	
209116	Motor camshaft	-	1	-	1	1	
203063	Motor camshaft bearing No. 1	-	1	-	1	1	
215422	Motor camshaft bearing No. 1	1	-	1	-	-	
215423	Motor camshaft bearing No. 1 adjustment plate ..	1	-	1	-	-	
7857	Screw 5/16-18 x 1 hex. hd.	2	-	2	-	-	
5504	Lockwasher 5/16	2	-	2	-	-	
158137	Motor camshaft bearing No. 1 adjustment plate lock	2	-	2	-	-	
221040	Motor camshaft bearing No. 1 retainer assembly ..	-	1	-	1	1	
197648	Motor camshaft bearing No. 1 retainer dowel ...	-	2	-	2	2	
203050	Motor camshaft bearing No. 1 retainer gasket ..	-	1	-	1	1	
203048	Motor camshaft bearing No. 1 retainer plug	-	1	-	1	1	
6107	Motor camshaft bearing No. 1 retainer stud 7/16 x 1-13/16	-	3	-	3	3	
7007	Nut 7/16-20	-	3	-	3	3	
5508	Lockwasher 7/16	-	3	-	3	3	
203064	Motor camshaft bearing No. 2 and No. 3	-	2	-	2	2	
215482	Motor camshaft bearing No. 2	1	-	1	-	-	
215483	Motor camshaft bearing No. 3	1	-	1	-	-	
215054	Motor camshaft bearing No. 4 assembly	1	-	1	-	-	
203065	Motor camshaft bearing No. 4	-	1	-	1	1	
66570	Motor camshaft bearing No. 4 plug	-	1	-	1	1	
207608	Motor camshaft bearing No. 4 dowel	1	-	1	-	-	
7706	Motor camshaft bearing No. 4 screw No. 10-32 x 1/2 fill. hd.	4	-	4	-	-	
6397	Lockwasher 3/16 (Shakeproof)	4	-	4	-	-	
215057	Motor camshaft bearing No. 5	1	-	1	-	-	
215058	Motor camshaft bearing No. 6	1	-	1	-	-	
215059	Motor camshaft bearing No. 7	1	-	1	-	-	
215074	Motor camshaft bearing No. 8 assembly	1	-	1	-	-	
7857	Screw 5/16-18 x 1 hex. hd.	3	-	3	-	-	
5504	Lockwasher 5/16	3	-	3	-	-	
147237	Motor camshaft bearing No. 8 retainer gasket ..	1	-	1	-	-	
202895	Motor camshaft driving chain	-	1	-	1	1	
231423	Motor camshaft driving chain	1	-	1	-	-	
201070	Motor camshaft nut	-	1	-	1	1	
201071	Motor camshaft nut lock	-	1	-	1	1	
197683	Motor camshaft oil pump drive gear	-	1	-	1	1	
4558	Key No. 6 Whitney	-	1	-	1	1	
147254	Motor camshaft plug	1	-	1	-	-	
6141	Motor camshaft plug (3/4 pipe)	-	1	-	1	1	

SERVICE PARTS LIST--PACKARD SUPER-EIGHT AND TWELVE

Motor Carburetor 85

Piece No.	Name	1500	1506	1603	1607	1707	
		1501	1507	1604	1608	1708	
		1502	1508	1605	No. Required		
234584	Motor camshaft rocker lever assembly--right ...	8	-	8	-	-	
234585	Motor camshaft rocker lever assembly--left	8	-	8	-	-	
203923	Motor camshaft rocker lever assembly	-	24	-	24	24	
216130	Motor camshaft rocker lever housing	2	-	2	-	-	
6050	Stud 5/16 special	20	-	20	-	-	
7005	Nut 5/16-24	20	-	20	-	-	
5504	Lockwasher 5/16	20	-	20	-	-	
215640	Motor camshaft rocker lever housing dowel	3	-	3	-	-	
216132	Motor camshaft rocker lever housing gasket	2	-	2	-	-	
223711	Motor camshaft rocker lever housing plug	4	-	4	-	-	
191671	Motor camshaft rocker lever plug	16	-	16	-	-	
205172	Motor camshaft rocker lever shaft	-	6	-	6	6	
234601	Motor camshaft rocker lever shaft	2	-	2	-	-	
197705	Motor camshaft rocker lever shaft plug	-	12	-	12	12	
197711	Motor camshaft rocker lever shaft retaining screw	-	6	-	6	6	
231422	Motor camshaft sprocket	1	-	1	-	-	
207525	Motor camshaft sprocket	-	1	-	1	1	
7857	Screw 5/16-18 x 1 hex. hd.	-	6	-	6	6	
5504	Lockwasher 5/16	-	6	-	6	6	
3994	Motor camshaft sprocket key 1/4 x 3/16 x 1-3/8 rectangular	1	-	1	-	-	
207520	Motor camshaft sprocket hub	-	1	-	1	1	
4506	Key No. 11 (Whitney)	-	1	-	1	1	
147253	Motor camshaft sprocket nut	1	-	1	-	-	
5446	Motor camshaft sprocket nut cotter pin 3/32 x 2	1	-	1	-	-	

MOTOR CARBURETOR

0237811	Motor carburetor gasket equipment	1	-	1	-	-
0237812	Motor carburetor gasket equipment	-	1	-	1	1
232165	Motor carburetor assembly	1	-	1	-	-
232166	Motor carburetor assembly	-	1	-	1	1
239471	Motor carburetor automatic choke assembly (Supersedes 210243)	-	1	-	1	1
5295	Screw 1/4-28 x 1 hex. hd.	-	2	-	2	2
3868	Washer 1/4	-	2	-	2	2
5502	Lockwasher 1/4	-	2	-	2	2
219888	Motor carburetor automatic choke thermostat ...	1	-	1	-	-
5312	Screw No. 8-32 x 3/8 oval hd.	2	-	2	-	-
210245	Motor carburetor automatic choke to carburetor connecting rod assembly	-	1	-	1	1
219926	Motor carburetor automatic choke to carburetor connecting rod	1	-	1	-	-
6423	Cotter pin 3/64 x 5/16	2	-	2	-	-
7003	Motor carburetor automatic choke to carburetor connecting rod ball joint nut No. 10-32	-	1	-	1	1
5500	Lockwasher No. 10	-	1	-	1	1
203635	Motor carburetor automatic choke to manifold gasket	-	1	-	1	1
216765	Motor carburetor gasket	2	-	2	-	-

Piece No.	Name	1500	1506	1603	1607	1707	
		1501	1507	1604	1608	1708	
		1502	1508	1605	No. Required		
201067	Motor carburetor gasket	-	1	-	1	1	
0242312	Motor carburetor gasket (Used with shim 242311)	-	1	-	1	1	
210442	Motor carburetor heat deflector	1	-	1	-	-	
216764	Motor carburetor insulator	1	-	1	-	-	
197804	Motor carburetor retaining stud	-	4	-	4	4	
5506	Lockwasher 3/8	-	4	-	4	4	
205429	Nut 3/8-24	-	4	-	4	4	
0242311	Motor carburetor shim (wedge shaped) 3°	-	1	-	1	1	
205611	Motor carburetor silencer and air cleaner assy.	-	1	-	-	-	
240690	Motor carburetor silencer and air cleaner assy.	-	-	1	-	-	
237563	Motor carburetor silencer and air cleaner assy.	1	-	-	-	-	
239763	Motor carburetor silencer and air cleaner assy.	-	-	-	1	1	
5578	Screw 5/16-24 x 7/8 hex. hd.	-	2	-	2	2	
3874	Washer 5/16	-	2	-	2	2	
5504	Lockwasher 5/16	-	2	-	2	2	
205687	Motor carburetor silencer and air cleaner gasket	-	1	-	1	1	
237564	Motor carburetor silencer and air cleaner support	1	-	-	-	-	
240691	Motor carburetor silencer and air cleaner support	-	-	1	-	-	
6104	Stud 1/4	2	-	2	-	-	
5502	Lockwasher 1/4	2	-	2	-	-	
7404	Nut 1/4-28 special	2	-	2	-	-	
6233	Motor carburetor stud 5/16 x 1-7/8 special	3	-	3	-	-	
5504	Lockwasher 5/16	3	-	3	-	-	
7405	Nut 5/16-24	3	-	3	-	-	

MOTOR CARBURETOR
(Bendix Stromberg No. EE-23)

The following parts are listed with the manufacturers' piece numbers and are to be ordered by these numbers. Dealers should order these parts through their distributor.

P-20292	Assembly--main body	1	-	1	-	-
P-7098-K	Plug 8-32--pump channel	4	-	4	-	-
P-6406-K	Plug 5/16-24--pump discharge channel	2	-	2	-	-
P-15457	Plug--drive No. 6--pump channel	2	-	2	-	-
P-16941	Gasket--main body	1	-	1	-	-
P-8012	Stud--main body attaching 1/4-20	1	-	1	-	-
P-17147	Nut--main body attaching stud	1	-	1	-	-
P-15554	Screw--fill. hd. 1/4-20 main body attaching .	3	-	3	-	-
P-19364	Jet--main discharge	2	-	2	-	-
P-17004	Jet--metering	2	-	2	-	-
P-18130-K	Plug--main metering jet-7/16-24	2	-	2	-	-
P-20823	Assembly--by-pass jet	1	-	1	-	-
P-6855	Gasket--by-pass jet	1	-	1	-	-
P-18388	Assembly--pump piston and link	1	-	1	-	-
P-17753	Spring--packing retainer	1	-	1	-	-
P-17060	Washer--pump link-splash	1	-	1	-	-

NOTE:--SEE SERVICE BULLETINS FOR CARBURETOR EXCHANGES.

SERVICE PARTS LIST--PACKARD SUPER-EIGHT AND TWELVE

Motor Carburetor 87

Piece No.	Name	1500	1506	1603	1607	1707	
		1501	1507	1604	1608	1708	
		1502	1508	1605	No. Required		
P-17380	Washer--pump link-felt	1	-	1	-	-	
P-15390	Cotter pin--pump link	1	-	1	-	-	
P-17045	Rod--pump	1	-	1	-	-	
P-9394-K	Washer--pump link	3	-	3	-	-	
P-7170	Cotter pin--pump rod and pump link	2	-	2	-	-	
P-16976	Assembly--pump lever	1	-	1	-	-	
P-6970	Screw--pump lever stop-No. 6-32	1	-	1	-	-	
P-16973	Screw--pump lever fulcrum-5/16-24	1	-	1	-	-	
P-17009	Washer--pump lever fulcrum screw	1	-	1	-	-	
P-17027	Screw--pump lever fulcrum screw lock No.10-32	1	-	1	-	-	
P-17133	Washer--pump lever fulcrum screw spring	1	-	1	-	-	
P-17042	Spring--pump lever	1	-	1	-	-	
P-16990	Assembly--pump check valve	1	-	1	-	-	
P-17007	Assembly--idle tube with holder	2	-	2	-	-	
P-17402-K	Valve--idle needle	2	-	2	-	-	
P-15481	Spring--idle needle valve	2	-	2	-	-	
P-15477-K	Air bleeder--idle	2	-	2	-	-	
P-15456	Screw--idle adjustor No. 10-32	1	-	1	-	-	
P-15831	Spring--idle adjustor screw	1	-	1	-	-	
P-17939-K	Screw--float lever fulcrum No. 10-32	1	-	1	-	-	
P-22533	Assembly--throttle lever and stem	1	-	1	-	-	
P-22526	Lever--throttle and pump	1	-	1	-	-	
P-19354	Stem--throttle	1	-	1	-	-	
P-19342	Throttle body	1	-	-	-	-	
P-17018	Valve--throttle (5 degree)	2	-	2	-	-	
P-16716	Screw--throttle valve No. 6-32	4	-	4	-	-	
P-15459	Plug--idle discharge holes-1/4"	2	-	2	-	-	
P-6387-K	Plug--idle discharge No. 10-32	2	-	2	-	-	
P-3292-K	Plug--1/8" pipe	1	-	1	-	-	
P-20463	Assembly--air horn and valve	1	-	1	-	-	
P-20465	Assembly--air horn	1	-	1	-	-	
P-18716	Cap--float chamber ventilator	1	-	1	-	-	
P-2369	Screw--float chamber ventilator cap attaching	1	-	1	-	-	
P-12167	Lockwasher--ventilator cap attaching screw ..	1	-	1	-	-	
P-19345	Assembly--choke valve	1	-	1	-	-	
P-19766-K	Assembly--choke stem and lever	1	-	1	-	-	
P-20229	Assembly--choke lever	1	-	1	-	-	
P-18300	Screw--choke lever clamp-No. 10-32	1	-	1	-	-	
P-18299	Nut--choke lever clamp screw	1	-	1	-	-	
P-4522	Screw--choke valve attaching No. 6-32	2	-	2	-	-	
P-17081-K	Collar--choke stem	1	-	1	-	-	
P-16161	Set screw--choke stem collar No. 8-32	1	-	1	-	-	
P-16426-K	Washer--choke stem	1	-	1	-	-	
P-6387-K	Plug--fast idle weight lever boss No. 10-32 ..	1	-	1	-	-	
P-17923	Gasket--air horn	1	-	1	-	-	
P-18111	Screw--air horn attaching 1/4-20	1	-	1	-	-	
P-46	Screw--air horn attaching No. 10-24	4	-	4	-	-	
P-6668	Lockwasher--air horn attaching screw	4	-	4	-	-	
P-19751	Assembly--auto choke unit	1	-	1	-	-	
P-19136	Assembly--cover and bushing	1	-	1	-	-	
P-18986	Assembly--kick lever and bushing	1	-	1	-	-	
P-19750	Assembly--lever and stem	1	-	1	-	-	

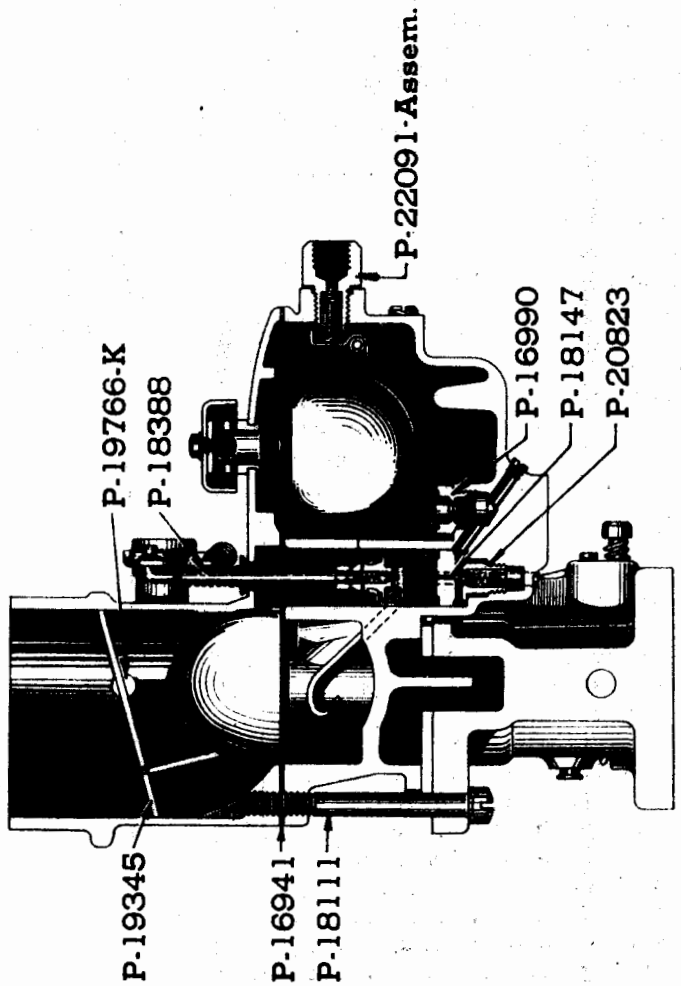
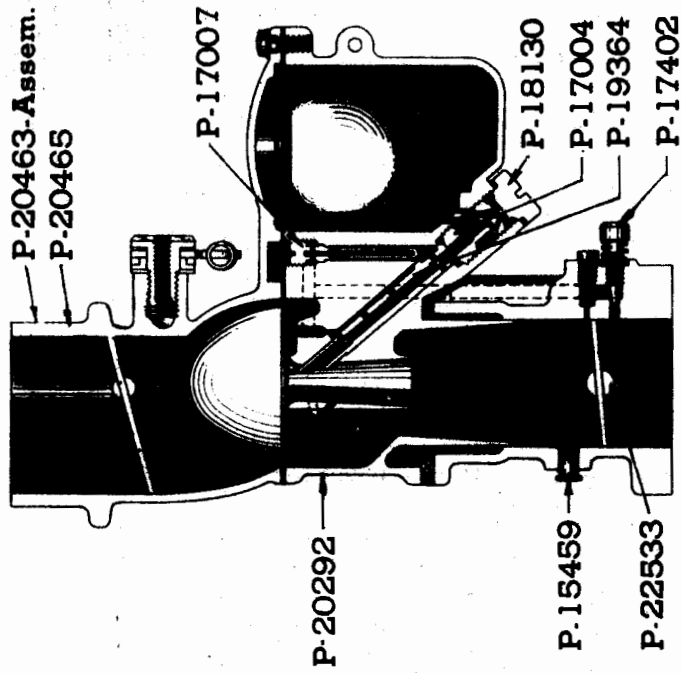

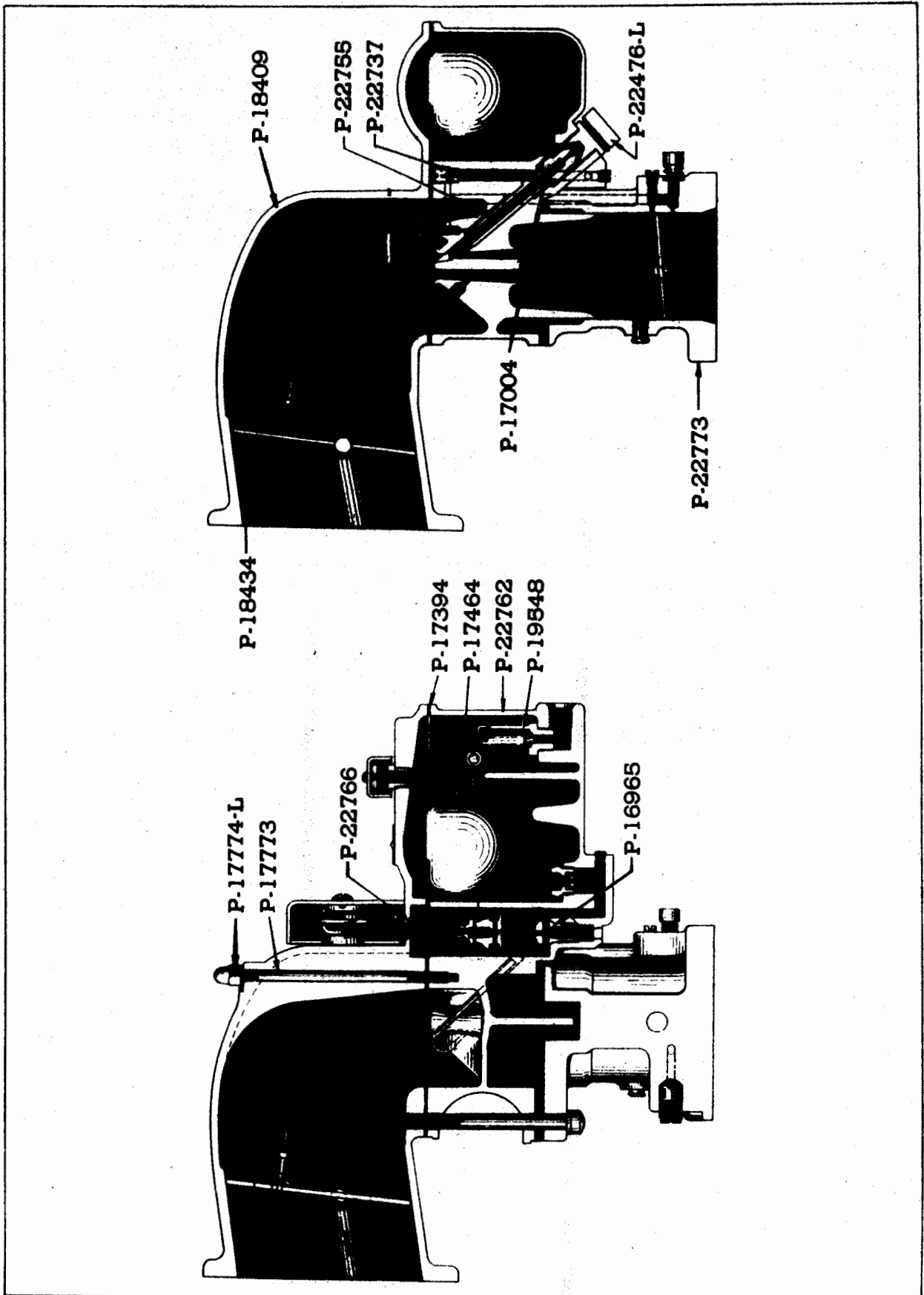

Models 1506-7-8, 1607-8

Piece No.	Name	1500	1506	1603	1607	1707	
		1501	1507	1604	1608	1708	
		1502	1508	1605	No. Required		
P-19125	Assembly--cam and pin	1	-	1	-	-	
P-19101	Pin--auto choke stem	1	-	1	-	-	
P-19104	Spring--auto choke cam	1	-	1	-	-	
P-19124	Gasket--auto choke unit	1	-	1	-	-	
P-19105	Screw--auto choke unit attaching No. 6-32	2	-	2	-	-	
P-18970	Pin--auto choke cover guide	2	-	2	-	-	
P-19980	Sleeve--vacuum piston	1	-	1	-	-	
P-19987	Piston--vacuum	1	-	1	-	-	
P-19662	Gasket--vacuum piston	1	-	1	-	-	
P-2369	Screw--piston stop-No. 8-32	1	-	1	-	-	
P-19982	Pin--piston adjustable	1	-	1	-	-	
P-19983	Lead ball--piston adjustor pin	1	-	1	-	-	
P-19351	Assembly--fast idle stop	1	-	1	-	-	
P-19341	Rod--fast idle	1	-	1	-	-	
P-4	Cotter pin--fast idle rod	1	-	1	-	-	
P-14159	Set screw--fast idle rod No. 8-32	1	-	1	-	-	
P-3157	Lockwashers (P-15554 and P-18111)	4	-	4	-	-	
P-10666	Gasket (P-18130 and P-22085K)	3	-	3	-	-	
P-20231	Assembly--thermostat unit	1	-	1	-	-	
P-21358	Assembly--thermostat plate and bushing	1	-	1	-	-	
P-20254	Assembly--thermostat stem and lever	1	-	1	-	-	
P-19113	Bracket--thermostat	1	-	1	-	-	
P-19114	Screw--bracket lock-No. 6-32	1	-	1	-	-	
P-21338	Cotter pin--thermostat stem	1	-	1	-	-	
P-22060	Thermostat	1	-	1	-	-	
P-16426	Washer--thermostat stem	1	-	1	-	-	
P-4	Cotter pin thermostat stem washer	1	-	1	-	-	
P-19144	Stop--thermostat lever	1	-	1	-	-	
P-17723	Screw--thermostat stop adjustor No. 8-32	1	-	1	-	-	
P-22091	Float needle valve and seat	1	-	1	-	-	
P-22088	Float assembly	1	-	1	-	-	

MOTOR CARBURETOR
(Bendix Stromberg No. EE-3)

The following parts are listed with the manufacturers' piece numbers and are to be ordered by these numbers. Dealers should order these parts through their distributor.

P-22395	Assembly--main body	-	1	-	1	1
P-7098-L	Plug--pump channel No. 8-32	-	4	-	4	4
P-6406-L	Plug--pump discharge channel-5/16-24	-	2	-	2	2
P-15457-L	Plug--drive-idle air bleed channel No. 6	-	2	-	2	2
P-17393	Gasket--main body	-	1	-	1	1
P-15554-L	Screw--fill. hd. 1/4-20 main body attaching	-	4	-	4	4
P-18111-L	Screw--fill. hd. 1/4-20 main body attaching	-	1	-	1	1
P-3157-L	Lockwasher--main body attaching screw	-	5	-	5	5
P-20647	Jet--main discharge	-	2	-	2	2
P-17004	Jet metering	-	2	-	2	2
P-22476-L	Plug--main meter jet-7/16-24	-	2	-	2	2

SERVICE PARTS LIST--PACKARD SUPER-EIGHT AND TWELVE

Motor Carburetor 91

Piece No.	Name	1500	1506	1603	1607	1707	
		1501	1507	1604	1608	1708	
		1502	1508	1605	No. Required		
P-60308	Gasket--main meter jet plug	-	2	-	2	2	
P-16965	Assembly--by-pass jet	-	1	-	1	1	
P-17448	Assembly--pump piston and link	-	1	-	1	1	
P-17753	Spring--packing retainer	-	1	-	1	1	
P-22856	Washer--pump link splash (Supersedes P-17060)	-	1	-	1	1	
P-17380	Washer--pump link--felt	-	1	-	1	1	
P-15390	Cotter pin--pump link	-	1	-	1	1	
P-17524	Assembly--pump lever	-	1	-	1	1	
P-6970	Screw--pump lever stop-No. 6-32	-	1	-	1	1	
P-16973	Screw--pump lever fulcrum 5/16-24	-	1	-	1	1	
P-17009	Washer--pump lever fulcrum screw	-	1	-	1	1	
P-17133	Washer--pump lever fulcrum screw spring	-	1	-	1	1	
P-18513	Spring--pump lever	-	1	-	1	1	
P-17442	Housing--pump lever	-	1	-	1	1	
P-11531-L	Screw--fill. hd. pump housing attaching No. 10-32	-	1	-	1	1	
P-22530-L	Assembly--pump rod	-	1	-	1	1	
P-16990	Assembly--pump check valve	-	1	-	1	1	
P-17007	Assembly--idle tube with holder	-	2	-	2	2	
P-15477-L	Air bleed--idle	-	2	-	2	2	
P-17891	Valve--idle needle	-	2	-	2	2	
P-15481-L	Spring--idle needle valve	-	2	-	2	2	
P-15456-L	Screw--idle adjustor No. 10-32	-	1	-	1	1	
P-15831-L	Spring--idle adjustor screw	-	1	-	1	1	
P-17464	Assembly--float with lever	-	1	-	1	1	
P-17446-L	Screw--float lever fulcrum No. 10-32	-	1	-	1	1	
P-11572	Gasket--float needle valve seat	-	1	-	1	1	
P-17473	Clip--float needle valve	-	1	-	1	1	
P-17063	Gasket--float lever fulcrum screw	-	1	-	1	1	
P-20668-K	Tag--code number	-	1	-	1	1	
P-22773	Assembly throttle body (Supersedes P-18363) .	-	1	-	1	1	
P-6387-L	Plug--idle discharge No. 10-32	-	2	-	2	2	
P-15459-L	Plug--idle discharge holes-1/4"	-	2	-	2	2	
P-17371	Valve--throttle (5 degree)	-	2	-	2	2	
P-15259	Screw--throttle valve No. 6-32	-	4	-	4	4	
P-1693-L	Lockwasher--throttle valve screw	-	4	-	4	4	
P-3292-L	Plug--decarbonizing boss 1/8" pipe	-	1	-	1	1	
P-22455	Assembly--throttle lever and stem	-	1	-	1	1	
P-18409	Assembly--air horn and valve	-	1	-	1	1	
P-18434	Assembly--choke valve	-	1	-	1	1	
P-4522	Screw--choke valve attaching No. 6-32	-	2	-	2	2	
P-18907	Assembly--choke lever	-	1	-	1	1	
P-18906-L	Screw--choke lever clamp No. 10-32	-	1	-	1	1	
P-18299-L	Nut--choke lever clamp screw	-	1	-	1	1	
P-17599	Assembly--choke balance lever	-	1	-	1	1	
P-46-L	Screw choke balance lever clamp No. 10-24 ...	-	1	-	1	1	
P-17759	Air horn	-	1	-	1	1	
P-17928-K	Ventilator--float chamber	-	1	-	1	1	
P-17828-L	Cover--float chamber ventilator	-	1	-	1	1	
P-4712-L	Screw--float chamber ventilator cap attaching No. 4-36	-	1	-	1	1	
P-17777	Stem--choke	-	1	-	1	1	

Piece No.	Name	1500	1506	1603	1607	1707	
		1501	1507	1604	1608	1708	
		1502	1508	1605	No. Required		
P-17081-L	Collar--choke stem	-	1	-	1	1	
P-16161-L	Set screw--choke stem collar-No. 8-32	-	1	-	1	1	
P-4735-L	Washer--choke balance lever spacer	-	1	-	1	1	
P-17556	Name plate	-	1	-	1	1	
P-14704-L	Rivet--name plate attaching	-	2	-	2	2	
P-17394	Gasket--air horn	-	1	-	1	1	
P-109-L	Screw--air horn attaching No. 10-24	-	4	-	4	4	
P-6668-L	Lockwasher--air horn and pump housing attaching screw	-	6	-	6	6	
P-17773	Stud--air horn attaching No. 10-24	-	1	-	1	1	
P-17774-L	Nut--air horn attaching stud	-	1	-	1	1	
P-18398-L	Rod--fast idle	-	1	-	1	1	
P-18390-L	Lever--fast idle weight	-	1	-	1	1	
P-18391-L	Lever--fast idle adjusting	-	1	-	1	1	
P-17968-L	Screw--fast idle weight lever fulcrum No. 10-32	-	1	-	1	1	
P-17999-L	Washer--fast idle weight lever fulcrum screw.	-	1	-	1	1	
P-17998-L	Screw--fast idle adj. lever adj. No. 8-32 ...	-	1	-	1	1	
P-17812-L	Nut--fast idle adj. lever adj. screw	-	1	-	1	1	
P-2290-L	Nut--fast idle adj. lever attaching	-	1	-	1	1	
P-1791-L	Lockwasher--fast idle adj. lever nut	-	1	-	1	1	
P-7170-L	Cotter pin (fast idle rod, pump rod and pump link)	-	4	-	4	4	
P-9394-L	Washer (fast idle rod and pump rod)	-	3	-	3	3	
P-19548	Float needle valve and seat	-	1	-	1	1	

MOTOR CONNECTING ROD

221631	Motor connecting rod--less bearing No. 1-3-5-7.	4	-	4	-	-
221632	Motor connecting rod--less bearing No. 2-4-6-8.	4	-	4	-	-
240325	Motor connecting rod--less bearing--left (Supersedes 219685)	-	6	-	6	6
240326	Motor connecting rod--less bearing--right (Supersedes 219688)	-	6	-	6	6
0225192	Motor connecting rod bearing assembly--standard (copper lead)	8	-	8	-	-
0225193	Motor connecting rod bearing assembly--.001 undersize (copper lead)	8	-	8	-	-
0225194	Motor connecting rod bearing assembly--.002 undersize (copper lead)	8	-	8	-	-
0225195	Motor connecting rod bearing assembly--.003 undersize (copper lead)	8	-	8	-	-
0225196	Motor connecting rod bearing assembly--.015 undersize (copper lead)	8	-	8	-	-
0225202	Motor connecting rod bearing assembly--right bank Standard (copper lead)	-	6	-	-	-
0225203	Motor connecting rod bearing assembly--right bank .001 undersize (copper lead)	-	6	-	-	-
0225204	Motor connecting rod bearing assembly--right bank .002 undersize (copper lead)	-	6	-	-	-

SERVICE PARTS LIST--PACKARD SUPER-EIGHT AND TWELVE

Motor Crankcase 93

Piece No.	Name	1500	1506	1603	1607	1707	
		1501	1507	1604	1608	1708	
		1502	1508	1605	No. Required		
0225205	Motor connecting rod bearing assembly--right bank .003 undersize (copper lead)	-	6	-	-	-	
0225206	Motor connecting rod bearing assembly--right bank .015 undersize (copper lead)	-	6	-	-	-	
0225207	Motor connecting rod bearing assembly--left bank Standard (copper lead)	-	6	-	-	-	
0225208	Motor connecting rod bearing assembly--left bank .001 undersize (copper lead)	-	6	-	-	-	
0225209	Motor connecting rod bearing assembly--left bank .002 undersize (copper lead)	-	6	-	-	-	
0225210	Motor connecting rod bearing assembly--left bank .003 undersize (copper lead)	-	6	-	-	-	
0225211	Motor connecting rod bearing assembly--left bank .015 undersize (copper lead)	-	6	-	-	-	
0239642	Motor connecting rod bearing assembly--right bank Standard (copper lead)	-	-	-	6	6	
0239644	Motor connecting rod bearing assembly--right bank .001 undersize (copper lead)	-	-	-	6	6	
0239646	Motor connecting rod bearing assembly--right bank .002 undersize (copper lead)	-	-	-	6	6	
0239648	Motor connecting rod bearing assembly--right bank .003 undersize (copper lead)	-	-	-	6	6	
0239650	Motor connecting rod bearing assembly--right bank .015 undersize (copper lead)	-	-	-	6	6	
0239643	Motor connecting rod bearing assembly--left bank Standard (copper lead)	-	-	-	6	6	
0239645	Motor connecting rod bearing assembly--left bank .001 undersize (copper lead)	-	-	-	6	6	
0239647	Motor connecting rod bearing assembly--left bank .002 undersize (copper lead)	-	-	-	6	6	
0239649	Motor connecting rod bearing assembly--left bank .003 undersize (copper lead)	-	-	-	6	6	
0239651	Motor connecting rod bearing assembly--left bank .015 undersize (copper lead)	-	-	-	6	6	
216214	Motor connecting rod bolt	16	-	16	-	-	
210071	Motor connecting rod bolt nut	16	-	16	-	-	
219594	Motor connecting rod bolt nut	-	24	-	24	24	
4290	Cotter pin 3/32 x 5/8	16	-	16	-	-	
4291	Cotter pin 3/32 x 3/4	-	24	-	24	24	
0213935	Motor connecting rod piston pin bushing	8	-	8	-	-	
0213936	Motor connecting rod piston pin bushing	-	12	-	12	12	
0166698	Motor connecting rod piston pin bushing (.002" oversize on outside diameter)	x	-	x	-	-	
0156494	Motor connecting rod piston pin bushing (.002" oversize on outside diameter)	-	x	-	x	x	

MOTOR CRANKCASE

232127	Motor crankcase and bearing caps assembly	1	-	1	-	-
132685	Motor crankcase to cylinder stud--large	18	-	18	-	-

NOTE:—SEE SERVICE BULLETINS FOR MOTOR CRANKCASE EXCHANGES.

94 Motor Crankshaft

SERVICE PARTS LIST--PACKARD SUPER-EIGHT AND TWELVE

Piece No.	Name	1500	1506	1603	1607	1707	
		1501	1507	1604	1608	1708	
		1502	1508	1605	No. Required		
7007	Nut 7/16-20--large	18	-	18	-	-	
5508	Lockwasher 7/16	18	-	18	-	-	
177923	Motor crankcase to cylinder stud--small	8	-	8	-	-	
7006	Nut 3/8-24--small	8	-	8	-	-	
5506	Lockwasher 3/8	8	-	8	-	-	
207570	Motor crankcase fuel pump plunger bushing	1	-	1	-	-	
110196	Motor crankcase fuel pump plunger hole plug ...	1	-	1	-	-	
6325	Motor crankcase to fuel pump stud 5/16 x 2-1/8.	2	-	2	-	-	
7005	Nut 5/16-24	2	-	2	-	-	
5504	Lockwasher 5/16	2	-	2	-	-	
6228	Washer 5/16	2	-	2	-	-	
207994	Motor crankcase link	2	2	2	2	2	
5434	Screw 1/4-28 x 1-5/8 hex. hd.	2	2	2	2	2	
5502	Lockwasher 1/4	2	2	2	2	2	
7004	Nut 1/4-28	2	2	2	2	2	
234840	Motor crankcase link ball	1	1	1	1	1	
5510	Lockwasher 1/2	1	1	1	1	1	
7008	Nut 1/2-20	2	2	2	2	2	
209054	Motor crankcase link ball insulator	2	2	2	2	2	
234838	Motor crankcase link ball spacer	1	1	1	1	1	
221369	Motor crankcase link bracket	1	1	1	1	1	
6269	Screw 3/8-24 x 2-1/4 hex. hd.	2	-	2	-	-	
7891	Screw 3/8-24 x 2-3/8 hex. hd.	-	2	-	2	2	
5506	Lockwasher 3/8	2	2	2	2	2	
7006	Nut 3/8-24	2	2	2	2	2	
146303	Motor crankcase to motor gear cover dowel	2	-	2	-	-	
146303	Motor crankcase to oil pan dowel	2	-	2	-	-	
6115	Motor crankcase to oil pan stud--short 5/16 std.	22	-	22	-	-	
6315	Stud--long (5/16 standard)	4	-	4	-	-	
7005	Nut 5/16-24	26	-	26	-	-	
3874	Washer 5/16	26	-	26	-	-	
5504	Lockwasher 5/16	26	-	26	-	-	
120917	Motor crankcase oil pressure gauge connection .	1	-	1	-	-	
5443	Motor crankcase oil pressure gauge connection 1/4 flared tube union	-	1	-	1	1	
184310	Motor crankcase timing indicator	1	-	1	-	-	
7711	Screw 1/4-20 x 5/8 fill. hd.	2	-	2	-	-	
5502	Lockwasher 1/4	2	-	2	-	-	
213771	Motor crankcase to transmission case stud--long	1	-	1	-	-	
190475	Motor crankcase to transmission case stud-- intermediate	5	-	5	-	-	
5666	Stud--short (3/8 standard)	2	-	2	-	-	
5506	Lockwasher 3/8	8	-	8	-	-	
7006	Nut 3/8-24	8	-	8	-	-	

MOTOR CRANKSHAFT

190503	Motor crankshaft and counterweights assembly ..	1	-	1	-	-
240333	Motor crankshaft and counterweights assembly ..	-	-	-	1	1
219704	Motor crankshaft and counterweights assembly ..	-	1	-	1	1
0176263	Motor crankshaft bearing No. 1 assembly	1	-	1	-	-

NOTE:--SEE SERVICE BULLETINS FOR MOTOR CRANKSHAFT EXCHANGES.

LITHOGRAPHED IN U. S. A.

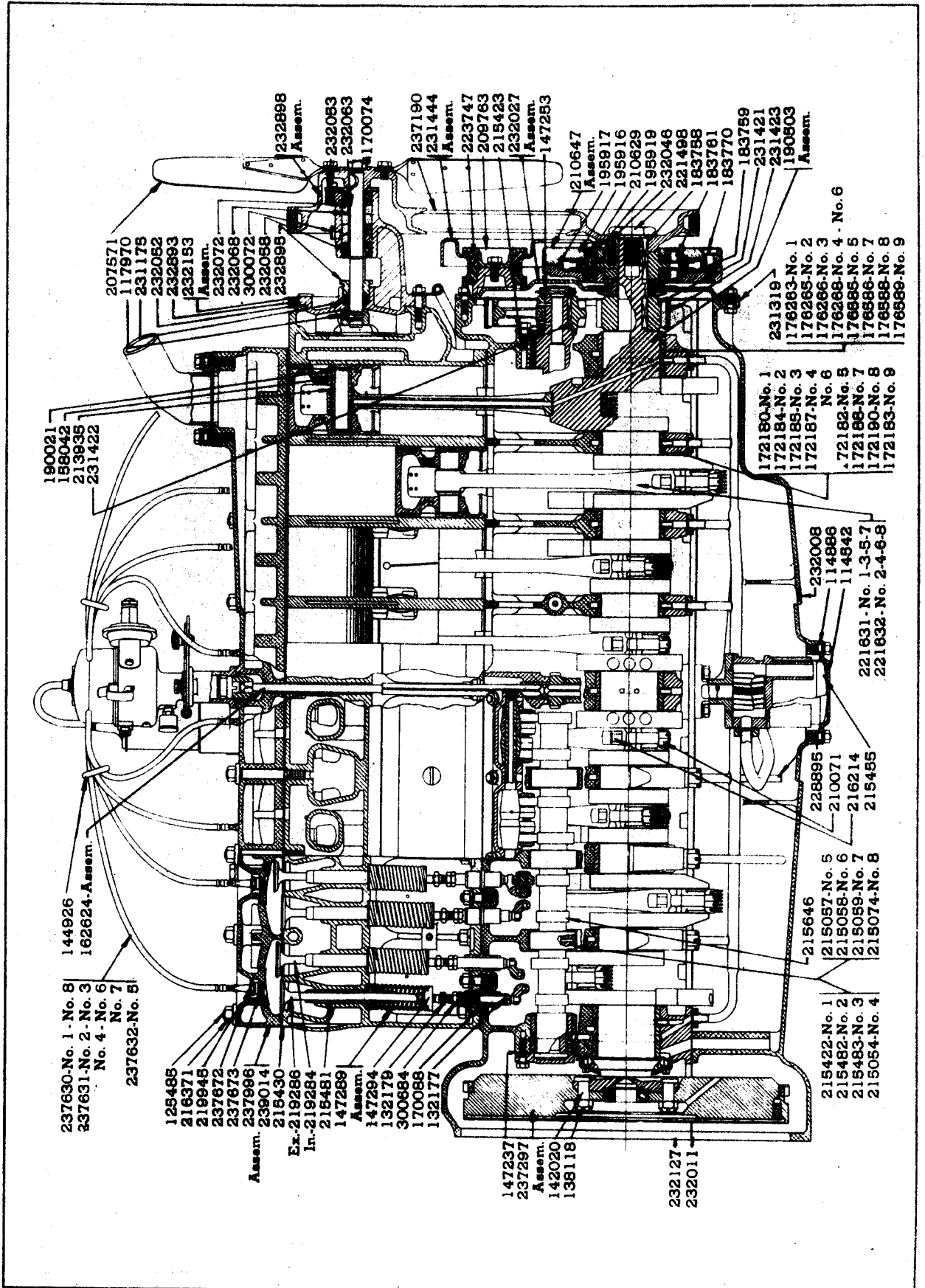

Models 1500-1-2

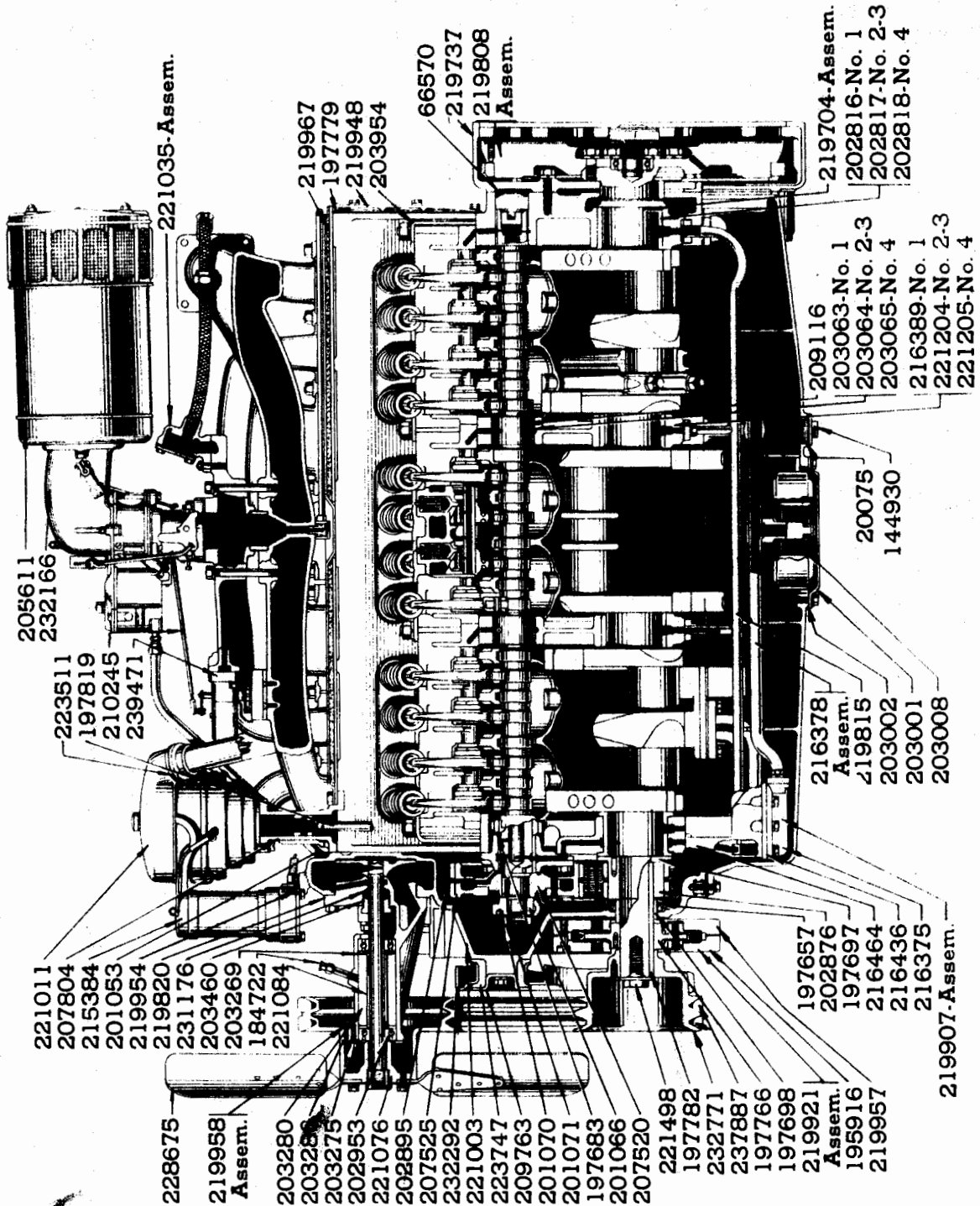

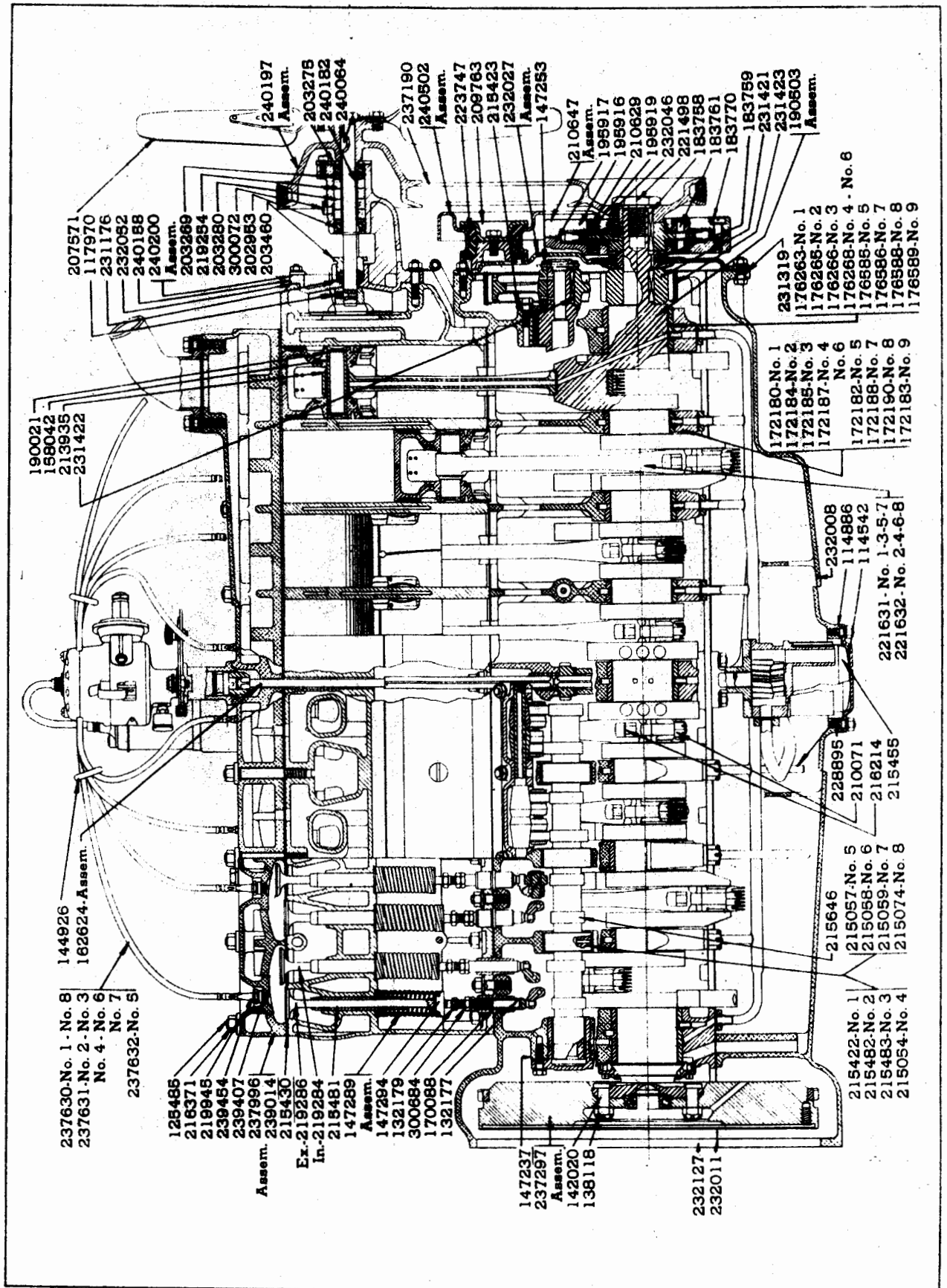

- 207571
- 117970
- 231176
- 232082
- 240188
- 240200
- Assem.
- 203269
- 219254
- 203280
- 300072
- 202983
- 203460
- 240197
- Assem.
- 203275
- 240182
- 240084
- 237190
- 240902
- Assem.
- 223747
- 209763
- 218423
- 232027
- Assem.
- 147253
- 210647
- Assem.
- 195917
- 195916
- 210629
- 195919
- 232046
- 221498
- 183758
- 183761
- 183770
- 183759
- 231421
- 231423
- 190603
- Assem.
- 231319
- 176263-No. 1
- 176266-No. 2
- 176266-No. 3
- 176268-No. 4 - No. 6
- 176585-No. 5
- 176586-No. 7
- 176588-No. 8
- 176589-No. 9
- 190021
- 158042
- 213935
- 231422
- 144926
- 162624-Assem.
- 237630-No. 1 - No. 8
- 237631-No. 2 - No. 3
- No. 4 - No. 6
- No. 7
- 237632-No. 5
- 128486
- 216371
- 219945
- 239454
- 239407
- 237996
- Assem.
- 239014
- 215430
- Ex.-219286
- In.-219284
- 215481
- 147289
- Assem.
- 147294
- 132179
- 300684
- 170088
- 132177
- 147237
- 237297
- Assem.
- 142020
- 138118
- 232127
- 232011
- 228895
- 210071
- 216214
- 215455
- 215646
- 215057-No. 5
- 215058-No. 6
- 215059-No. 7
- 215074-No. 8
- 215422-No. 1
- 215482-No. 2
- 215483-No. 3
- 215054-No. 4
- 232008
- 114886
- 114542
- 221631 - No. 1-3-5-7
- 221632 - No. 2-4-6-8

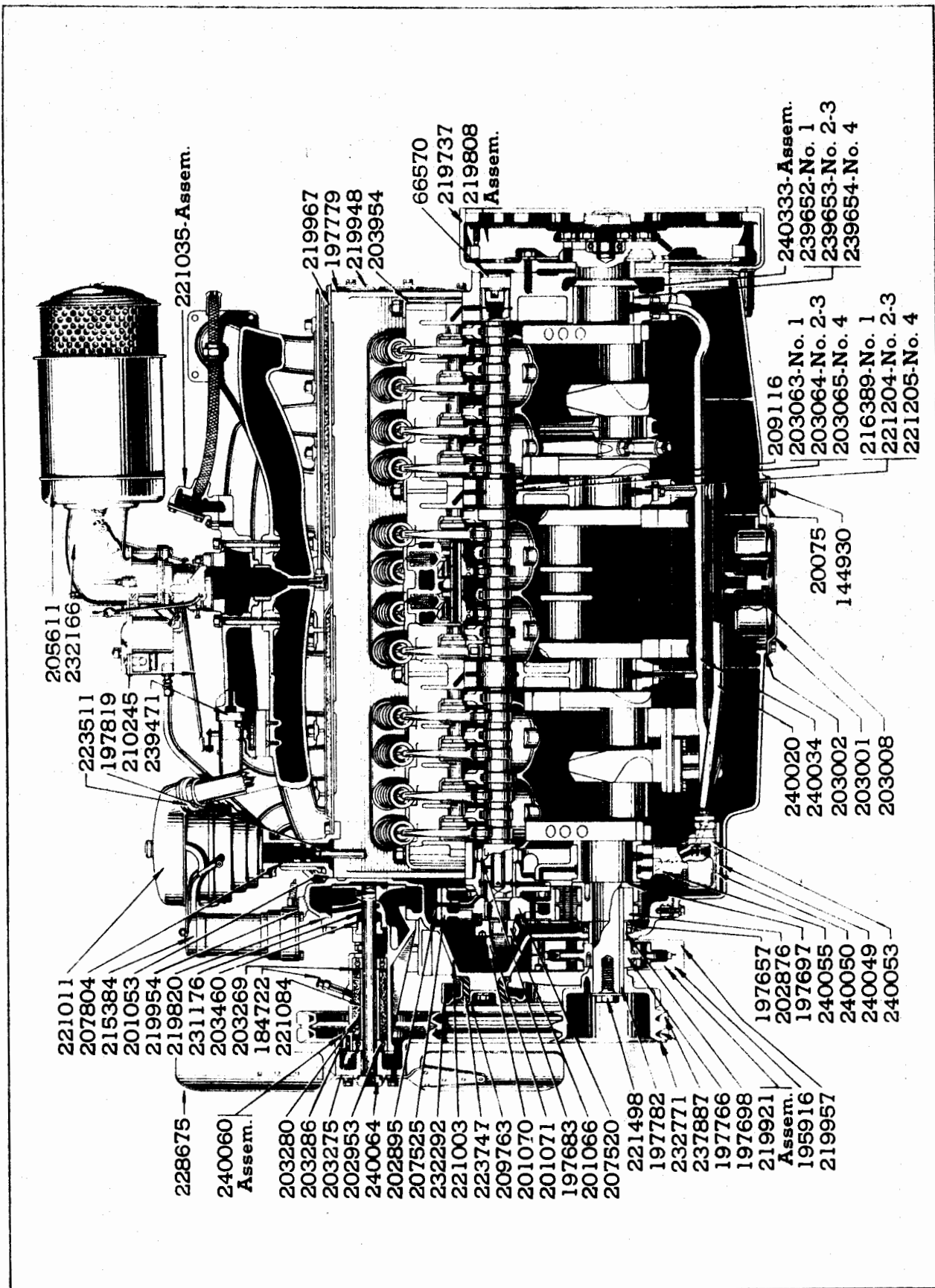

Models 1607-8, 1707-8

SERVICE PARTS LIST--PACKARD SUPER-EIGHT AND TWELVE

Motor Crankshaft 99

Piece No.	Name	1500	1506	1603	1607	1707	
		1501	1507	1604	1608	1708	
		1502	1508	1605	No. Required		
0176265	Motor crankshaft bearing No. 2 assembly	1	-	1	-	-	
0176266	Motor crankshaft bearing No. 3 assembly	1	-	1	-	-	
0176268	Motor crankshaft bearing No. 4 and 6 assembly .	2	-	2	-	-	
0176585	Motor crankshaft bearing No. 5 assembly	1	-	1	-	-	
0176586	Motor crankshaft bearing No. 7 assembly	1	-	1	-	-	
0176588	Motor crankshaft bearing No. 8 assembly	1	-	1	-	-	
0176589	Motor crankshaft bearing No. 9 assembly	1	-	1	-	-	
0239652	Motor crankshaft bearing No. 1 assembly (Supersedes 0202816)	-	1	-	1	1	
0239653	Motor crankshaft bearing No. 2 and 3 assembly (Supersedes 0202817)	-	2	-	2	2	
0239654	Motor crankshaft bearing No. 4 assembly (Supersedes 0202818)	-	1	-	1	1	
172180	Motor crankshaft bearing cap No. 1	1	-	1	-	-	
216389	Motor crankshaft bearing cap No. 1	-	1	-	1	1	
172184	Motor crankshaft bearing cap No. 2	1	-	1	-	-	
221204	Motor crankshaft bearing cap No. 2 and No. 3 ..	-	2	-	2	2	
172185	Motor crankshaft bearing cap No. 3	1	-	1	-	-	
172187	Motor crankshaft bearing cap No. 4 and No. 6 ..	2	-	2	-	-	
221205	Motor crankshaft bearing cap No. 4	-	1	-	1	1	
201887	Motor crankshaft bearing cap No. 4 cork seal ..	-	2	-	2	2	
172182	Motor crankshaft bearing cap No. 5	1	-	1	-	-	
172188	Motor crankshaft bearing cap No. 7	1	-	1	-	-	
172190	Motor crankshaft bearing cap No. 8	1	-	1	-	-	
172183	Motor crankshaft bearing cap No. 9	1	-	1	-	-	
4754	Dowel pin 1/4 x 1-1/4	2	-	2	-	-	
0130011	Motor crankshaft bearing cap No. 9 oil retainer assembly	1	-	-	-	-	
5257	Screw No. 10-32 x 29/32 fill. hd.	8	-	8	-	-	
120813	Lockwire (7" long)	4	-	4	-	-	
125863	Motor crankshaft bearing cap No. 9 oil seal ...	2	-	2	-	-	
158670	Motor crankshaft bearing cap No. 9 wrench hole plug	2	-	2	-	-	
158686	Motor crankshaft bearing cap stud	12	-	12	-	-	
6186	Stud 1/2-20 x 3-13/16 special	-	8	-	8	8	
158688	Motor crankshaft bearing cap stud center andft.	8	-	8	-	-	
158687	Motor crankshaft bearing cap stud--rear	4	-	4	-	-	
7107	Nut 7/16-20 castle	8	-	8	-	-	
7108	Nut 1/2-20 castle	14	8	14	8	8	
7008	Nut 1/2-20	2	-	2	-	-	
4291	Motor crankshaft bearing cap stud cotter pin 3/32 x 3/4	22	8	22	8	8	
5510	Lockwasher 1/2	2	-	2	-	-	
141409	Motor crankshaft bearing cap stud washer--spl..	4	-	4	-	-	
239041	Motor crankshaft bearing cap stud washer--spl. (Supersedes 158669)	16	8	16	8	8	
203042	Motor crankshaft bearing dowel	-	4	-	4	4	
114673	Motor crankshaft bearing dowel--lower	9	-	9	-	-	
111980	Motor crankshaft bearing dowel--upper	8	-	8	-	-	
232046	Motor crankshaft fan pulley	1	-	1	-	-	
232771	Motor crankshaft fan pulley	-	1	-	1	1	
221498	Motor crankshaft fan pulley screw	1	1	1	1	1	

100 Motor Cylinder

SERVICE PARTS LIST--PACKARD SUPER-EIGHT AND TWELVE

Piece No.	Name	1500	1506	1603	1607	1707
		1501	1507	1604	1608	1708
		1502	1508	1605	No. Required	
197782	Motor crankshaft key	-	1	-	1	1
179169	Motor crankshaft oil deflector	1	-	1	-	-
197657	Motor crankshaft oil seal	-	1	-	1	1
231421	Motor crankshaft sprocket	1	-	1	-	-
202876	Motor crankshaft sprocket	-	1	-	1	1
4001	Key 5/16 x 1/4 x 1-3/8 rectangular	1	-	1	-	-
197697	Motor crankshaft thrust plate	-	1	-	1	1
5537	Dowel 5/16 x 15/16	-	1	-	1	1
197696	Motor crankshaft thrust plate shim .002	-	1	-	1	1
197695	Motor crankshaft thrust plate shim .005	-	x	-	x	x
201910	Motor crankshaft thrust plate shim 1/32	-	x	-	x	x

MOTOR CYLINDER

0225020	Motor cylinder and piston assembly--standard ..	1	-	-	-	-
0242191	Motor cylinder and piston assembly--standard ..	-	-	1	-	-
0225021	Motor cylinder and piston assembly--oversize ..	1	-	-	-	-
0242192	Motor cylinder and piston assembly--oversize ..	-	-	1	-	-
0225062	Motor cylinder and piston assembly--standard ..	-	1	-	1	1
0225063	Motor cylinder and piston assembly--oversize ..	-	1	-	1	1
68601	Motor cylinder core hole plug (Expansion plug 1 ⁿ)	6	-	6	-	-
197816	Motor cylinder core hole plug	-	1	-	1	1
170148	Motor cylinder to crankcase gasket	1	-	-	-	-
239760	Motor cylinder to crankcase gasket	-	-	1	-	-
219948	Motor cylinder end plate--rear	-	1	-	1	1
7804	Motor cylinder end plate rear--screw 5/16 x 3/4 hex. hd.	-	6	-	6	6
5504	Lockwasher 5/16	-	6	-	6	6
3874	Washer 5/16	-	6	-	6	6
197779	Motor cylinder end plate rear gasket	-	1	-	1	1
6573	Motor cylinder head core hole plug 3/8-18 pipe headless	4	-	4	-	-
6646	Pipe plug 3/8-18 hex. hd.	1	-	1	-	-
77748	Motor cylinder head core hole plug	-	4	-	4	4
237996	Motor cylinder head and core hole plug assembly (6.50 to 1 ratio) Standard	1	-	1	-	-
237698	Motor cylinder head and core hole plug right assembly (6.4 to 1 ratio) Standard	-	1	-	1	1
237699	Motor cylinder head and core hole plug left assembly (6.4 to 1 ratio) Standard	-	1	-	1	1
239014	Motor cylinder head and core hole plug assembly (7.00 to 1 ratio)	1	-	1	-	-
237694	Motor cylinder head and core hole plug left assembly (6.00 to 1 ratio)	-	1	-	1	1
237695	Motor cylinder head and core hole plug right assembly (6.00 to 1 ratio)	-	1	-	1	1
237696	Motor cylinder head and core hole plug left assembly (7.00 to 1 ratio)	-	1	-	1	1
237697	Motor cylinder head and core hole plug right assembly (7.00 to 1 ratio)	-	1	-	1	1
215430	Motor cylinder head gasket	1	-	1	-	-

NOTE:--SEE SERVICE BULLETINS FOR MOTOR CYLINDER AND PISTON EXCHANGES.

LITHOGRAPHED IN U. S. A

SERVICE PARTS LIST--PACKARD SUPER-EIGHT AND TWELVE

Motor Cylinder 101

Piece No.	Name	1500	1506	1603	1607	1707	
		1501	1507	1604	1608	1708	
		1502	1508	1605	No. Required		
197821	Motor cylinder head gasket	-	2	-	2	2	
223685	Motor cylinder head stud--intermediate (for horn bracket)	-	-	2	-	-	
125485	Motor cylinder head stud--short	25	-	23	-	-	
223685	Motor cylinder head stud--long	2	-	-	-	-	
242026	Motor cylinder head stud--long (for ignition coil)	-	-	2	-	-	
6308	Stud--inter 1/2	-	28	-	28	28	
6143	Stud--long 1/2 x 4 special	-	14	-	14	14	
216371	Motor cylinder head stud nut	27	-	27	-	-	
203874	Motor cylinder head stud nut (1/2-20 blind) ...	-	42	-	42	42	
3884	Washer 1/2	-	8	-	8	8	
213902	Motor cylinder head stud washer 1/2" special ..	-	38	-	38	38	
219945	Motor cylinder head stud washer--thick	27	-	27	-	-	
3883	Washer--thin 7/16	2	-	-	-	-	
300788	Motor cylinder head thermometer sleeve	-	-	1	1	1	
221951	Motor cylinder head water outlet flange--left .	-	1	-	1	1	
221950	Motor cylinder head water outlet flange--right.	-	1	-	1	1	
234939	Motor cylinder head water outlet flange	1	-	-	-	-	
240475	Motor cylinder head water outlet flange	-	-	1	-	-	
221462	Motor cylinder head water outlet flange gasket.	1	-	1	-	-	
203454	Motor cylinder head water outlet flange gasket.	-	2	-	2	2	
300136	Motor cylinder head water outlet flange screw 3/8-16 x 1-1/8 hex. hd.	2	-	2	-	-	
6592	Screw 5/16-18 x 1-1/8 hex. hd.	-	4	-	4	4	
3877	Plain washer 3/8	2	-	2	-	-	
78945	Motor cylinder head water outlet flange screw gasket 3/8 annular special	2	-	2	-	-	
129439	Motor cylinder head water outlet flange screw gasket 5/16 annular	-	4	-	4	4	
197750	Motor cylinder to oil pan dowel	-	2	-	2	2	
232422	Motor cylinder ventilator tube and flange assy.	1	-	-	-	-	
6079	Screw 1/4-28 x 1/2 oval hd.	4	-	-	-	-	
159698	Motor cylinder ventilator tube flange gasket ..	1	-	-	-	-	
231498	Motor cylinder water inlet and plug assembly ..	1	-	1	-	-	
5566	Screw 5/16-24 x 1-1/8 hex. hd.	2	-	2	-	-	
5385	Lockwasher 5/16 (Shakeproof)	2	-	2	-	-	
6646	Pipe plug 3/8-18 hex. hd.	1	-	1	-	-	
197861	Motor cylinder water inlet gasket	1	-	1	-	-	
231419	Motor cylinder water inlet to oil cooler hose .	1	-	1	-	-	
203083	Motor cylinder water inlet to oil cooler hose clamp	2	-	2	-	-	
203976	Motor cylinder water jacket drain cock	-	2	-	2	2	
221055	Motor cylinder water jacket plate assembly	1	-	1	-	-	
197790	Motor cylinder water jacket plate	-	2	-	2	2	
7801	Screw 1/4-28 x 1/2 hex. hd.	37	-	37	-	-	
147295	Motor cylinder water jacket plate screw	3	-	3	-	-	
6465	Screw 5/16-18 x 5/8 hex. hd.	-	50	-	50	50	
209713	Motor cylinder water jacket plate screw washer.	-	56	-	56	56	
158185	Motor cylinder water jacket plate gasket	1	-	1	-	-	
197791	Motor cylinder water jacket plate gasket	-	2	-	2	2	

1 Dr Side
4
1

Left Side
on 38-39

LITHOGRAPHED IN U. S. A.

Simple MATTER of
Drilling #37 block for 38 Vent Tube - WLB

Piece No.	Name	1500	1506	1603	1607	1707
		1501	1507	1604	1608	1708
		1502	1508	1605	No. Required	
205981	Motor cylinder water jacket plate to instrument board oil pressure gauge tube lower assembly screw	-	2	-	2	2
209713	Washer	-	2	-	2	2
MOTOR DISTRIBUTOR						
221011	Motor distributor	-	1	-	1	1
239770	Motor distributor	-	-	1	-	-
237209	Motor distributor (Delco)	1	-	-	-	-
239539	Motor distributor (Auto-Lite)	1	-	-	-	-
230297	Motor distributor adjusting plate assy. (Delco)	1	-	-	-	-
239535	Motor distributor adjusting plate assembly (Auto-Lite)	1	-	1	-	-
230298	Motor distributor adjusting plate screw	2	-	-	-	-
300631	Motor distributor adjusting plate screw	-	-	2	-	-
3883	Washer 7/16 plain "N" standard	2	-	-	-	-
300644	Motor distributor adj. plate screw plain washer	-	-	4	-	-
230299	Motor distributor adj. plate screw spring	2	-	-	-	-
300632	Motor distributor adj. plate screw spring	-	-	2	-	-
5787	Motor distributor screw 1/4-28 x 7/8 hex. hd. .	-	3	-	3	3
5502	Lockwasher 1/4	-	3	-	3	3
205354	Motor distributor clamp screw washer special ..	-	3	-	3	3
230278	Motor distributor bracket	1	-	1	-	-
207804	Motor distributor bracket	-	1	-	1	1
6114	Stud (1/4 x 1-1/16)	3	-	3	-	-
3868	Washer 1/4	3	-	3	-	-
7004	Nut 1/4-28	3	-	3	-	-
5502	Lockwasher 1/4	3	-	3	-	-
197758	Motor distributor bracket dowel	-	2	-	2	2
201063	Motor distributor bracket gasket	-	1	-	1	1
201069	Motor distributor bracket retaining stud	-	2	-	2	2
7006	Nut 3/8-24	-	2	-	2	2
5506	Lockwasher 3/8	-	2	-	2	2
3877	Washer 3/8	-	2	-	2	2
0239573	Motor distributor breaker point set	1	-	-	-	-
0239575	Motor distributor breaker point set	-	1	-	1	1
0320426	Motor distributor breaker point set	-	-	1	-	-
162624	Motor distributor drive shaft assembly	1	-	1	-	-
197819	Motor distributor drive shaft assembly	-	1	-	1	1
197652	Motor distributor drive shaft lock ring	-	1	-	1	1
228644	Motor distributor high tension cable terminal water seal	1	-	-	-	-
237205	Motor distributor vacuum tube assembly	1	-	1	-	-
6572	Motor distributor vacuum tube elbow 3/16 flared tube weatherhead	1	-	1	-	-
6256	Motor distributor vacuum tube union connection 3/16 weatherhead	1	-	1	-	-
6571	Union nut 3/16 flared tube weatherhead ...	2	-	2	-	-

SERVICE PARTS LIST--PACKARD SUPER-EIGHT AND TWELVE

Motor Distributor 103

Piece No.	Name	1500	1506	1603	1607	1707
		1501	1507	1604	1608	1708
		1502	1508	1605		
						No. Required

MOTOR DISTRIBUTOR
(Delco Type No. 663-L)

The following parts are listed with the manufacturers' piece numbers and are to be ordered by these numbers. Dealers should order these parts through their distributor.

D-1866039	Distributor housing	X	-	-	-	-
D-1857894	Distributor cap	X	-	-	-	-
D-821604	Distributor cap carbon button	X	-	-	-	-
D-1857892	Distributor cap cover	X	-	-	-	-
D-824394	Distributor cap cover attaching screw	X	-	-	-	-
D-1836913	Distributor cap spring	X	-	-	-	-
D-1836915	Distributor cap spring pin	X	-	-	-	-
D-1853292	Distributor cap spring support	X	-	-	-	-
D-114935	Distributor cap spring support screw	X	-	-	-	-
D-141551	Distributor cap spring support screw lockwasher	X	-	-	-	-
D-1836893	Rotor	X	-	-	-	-
D-1840924	Main shaft (and weight plate)	X	-	-	-	-
D-1866041	Cam (automatic and breaker)	X	-	-	-	-
D-819639	Felt wick (in cam)	X	-	-	-	-
D-1866045	Breaker plate	X	-	-	-	-
D-104918	Breaker plate bearing ball	X	-	-	-	-
D-1865983	Breaker plate ground spring washer	X	-	-	-	-
D-1842058	Breaker lever	X	-	-	-	-
D-1858576	Breaker lever spring attaching screw	X	-	-	-	-
D-1865977	Breaker lever spring attaching screw insulator washer	X	-	-	-	-
D-821033	Breaker lever spring attaching screw insulator bushing washer	X	-	-	-	-
D-817363	Breaker lever spring attaching screw nut ...	X	-	-	-	-
D-1866047	Contact support and point	X	-	-	-	-
D-816784	Contact adjusting screw	X	-	-	-	-
D-1866049	Condenser	X	-	-	-	-
D-810074	Shim washer (.005 thick)	X	-	-	-	-
D-810078	Shim washer (.010 thick)	X	-	-	-	-
D-114935	Condenser attaching screw	X	-	-	-	-
D-141551	Condenser attaching screw lockwasher	X	-	-	-	-
D-818222	Weight	X	-	-	-	-
D-829567	Weight spring (6-1/2 turns .041 wire)	X	-	-	-	-
D-1835118	Weight spring (5-1/2 turns .046 wire)	X	-	-	-	-
D-811124	Weight washer	X	-	-	-	-
D-811912	Space washer (under weight plate)	X	-	-	-	-
D-1853625	Terminal stud (and bushing)	X	-	-	-	-
D-1865985	Terminal stud insulator bushing (inside) ...	X	-	-	-	-
D-817363	Terminal stud nut	X	-	-	-	-
D-121841	Terminal stud nut L. W.	X	-	-	-	-
D-26153	Terminal clamp	X	-	-	-	-
D-107710	Terminal clamp screw	X	-	-	-	-
D-121841	Terminal clamp screw L. W.	X	-	-	-	-

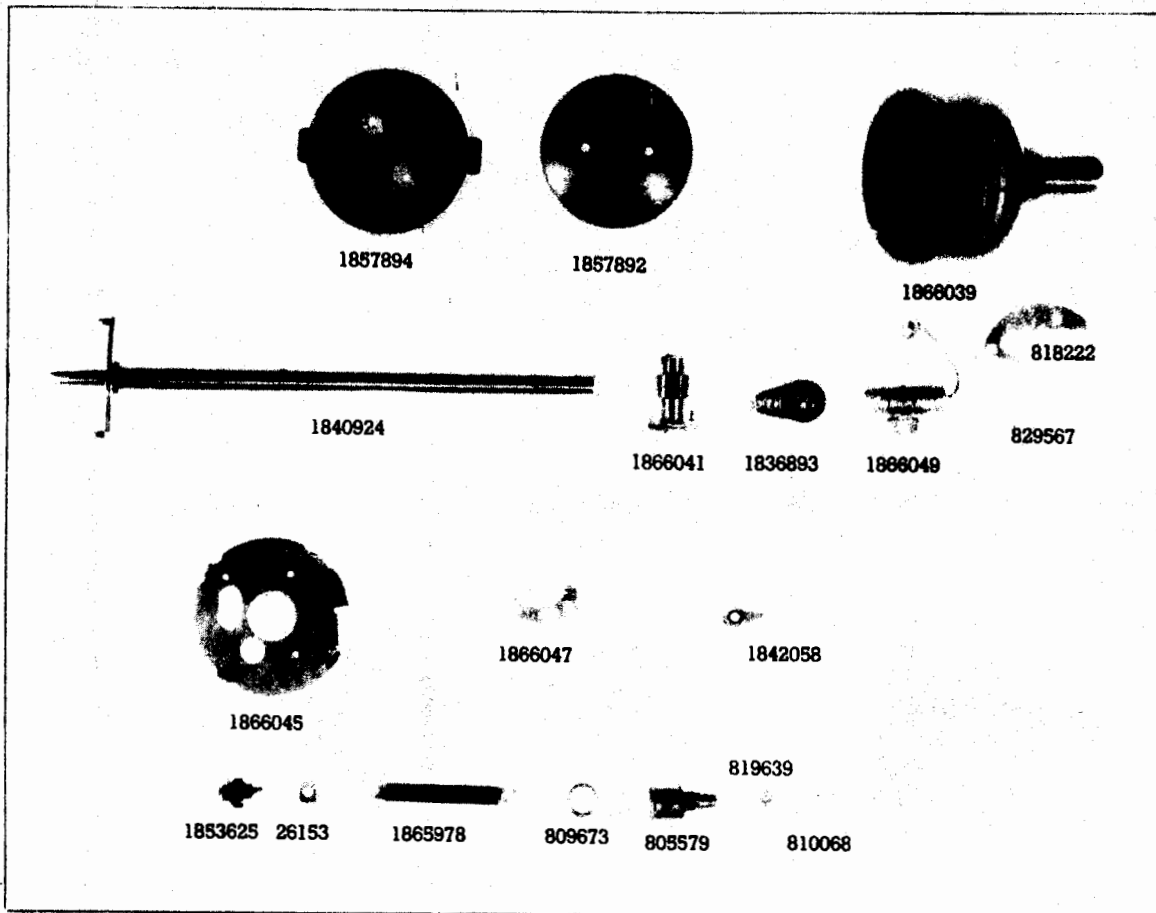

Models 1500-1-2

Piece No.	Name	1500	1506	1603	1607	1707	
		1501	1507	1604	1608	1708	
		1502	1508	1605	No. Required		
D-1865978	Terminal connector lead (to breaker plate) .	x	-	-	-	-	
D-681-L	Vacuum control	x	-	-	-	-	
D-1865984	Vacuum control bracket clamp	x	-	-	-	-	
D-135616	Vacuum control attaching screw	x	-	-	-	-	
D-141552	Vacuum control attaching screw lockwasher ..	x	-	-	-	-	
D-141542	Vacuum control arm attaching screw (to breaker plate)	x	-	-	-	-	
D-141550	Vacuum control arm attaching screw L. W. (to breaker plate)	x	-	-	-	-	
D-1857905	Low tension lead	x	-	-	-	-	
D-805579	Grease cup	x	-	-	-	-	
D-809673	Coupling	x	-	-	-	-	
D-810068	Coupling pin	x	-	-	-	-	
D-811912	Space washer (under coupling)	x	-	-	-	-	

SERVICE PARTS LIST--PACKARD SUPER-EIGHT AND TWELVE

Motor Distributor 105

Piece No.	Name	1500	1506	1603	1607	1707
		1501	1507	1604	1608	1708
		1502	1508	1605	No. Required	

MOTOR DISTRIBUTOR

(Electric Auto-Lite No. IGT-4005-For 1500-1-2)

(Electric Auto-Lite No. IGT-4006-For 1603-4-5)

The following parts are listed with the manufacturers' piece numbers and are to be ordered by these numbers. Dealers should order these parts through their distributor.

IG-90	Thrust washer	1	-	1	-	-
IG-680	Lock spring ring	1	-	1	-	-
IGB-162	Thrust washer	1	-	1	-	-
IGE-35	Governor control spring	1	-	1	-	-
IGH-28	Cam sleeve felt wick	1	-	1	-	-
IGT-1040	Distributor cap cover assembly	-	-	1	-	-
IGB-230	Gasket	-	-	1	-	-
IGT-1043	Secondary screw terminal	-	-	1	-	-
IGH-30	Distributor cap cover	1	-	-	-	-
IGH-36	Distributor cap nut	1	-	-	-	-
IGH-1029	Distributor cap assembly	1	-	-	-	-
IGT-1039	Distributor cap assembly	-	-	1	-	-
IG-514	Contact spring plunger	1	-	1	-	-
IG-515	Contact spring	1	-	1	-	-
IGH-1041	Rotor	1	-	-	-	-
IGP-1016	Rotor	-	-	1	-	-
IGH-1060A	Advance control arm	1	-	1	-	-
IGT-42	Washer--.020" thick	1	-	1	-	-
IGL-44	Distributor drive coupling	1	-	1	-	-
IGS-34	Terminal slot cover	1	-	1	-	-
IGT-18	Bearing clamp	2	-	2	-	-
IGT-23	Vacuum chamber bracket	1	-	1	-	-
IGT-38	Lead assembly	1	-	-	-	-
IGT-45	Lead assembly	-	-	1	-	-
X-590	Terminal	1	-	1	-	-
X-1053	Terminal	1	-	-	-	-
X-1052	Terminal	-	-	1	-	-
IGT-1022RC	Cam and stop plate--8 cylinder R.H.	1	-	1	-	-
IGT-1023FS	Vacuum chamber	1	-	1	-	-
IGT-2004D	Breaker plate assembly	1	-	1	-	-
IA-131	Breaker arm spring clip	1	-	1	-	-
IG-2671G	Condenser assembly	1	-	1	-	-
IGP-3028	Breaker arm assembly	1	-	1	-	-
IGP-30	Breaker arm spring	1	-	1	-	-
IGS-52	Lead clip	1	-	1	-	-
IGT-11	Lead assembly	1	-	-	-	-
IGT-11A	Lead assembly	-	-	1	-	-
X-935	Terminal	1	-	1	-	-
X-936	Terminal	1	-	1	-	-
IGT-1004D	Breaker plate part assembly	1	-	1	-	-
IGT-1012	Breaker sub plate assembly	1	-	1	-	-
IB-23	Breaker point lock nut	1	-	1	-	-
IGP-33	Breaker screw point	1	-	1	-	-

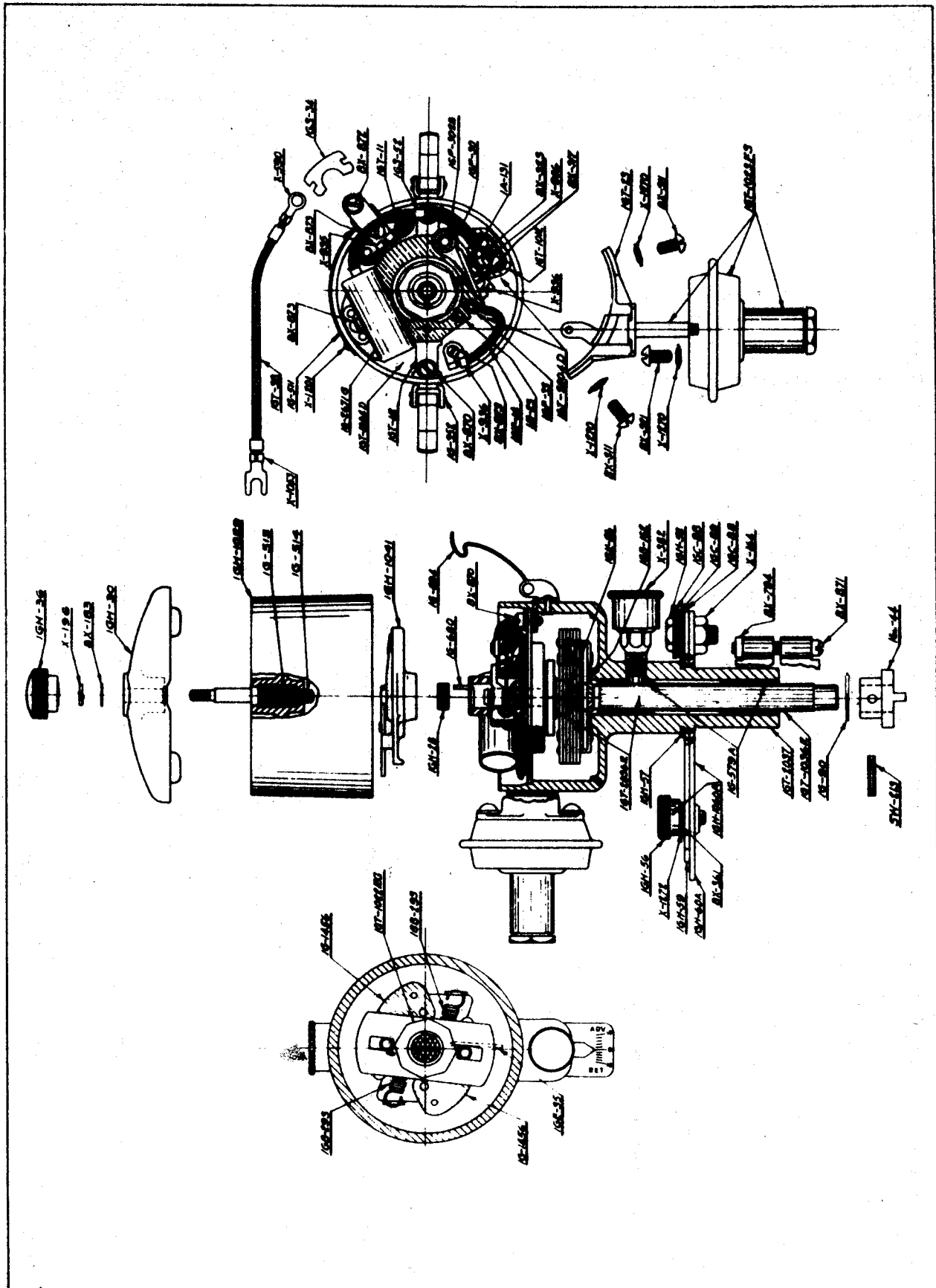

Models 1500-1-2

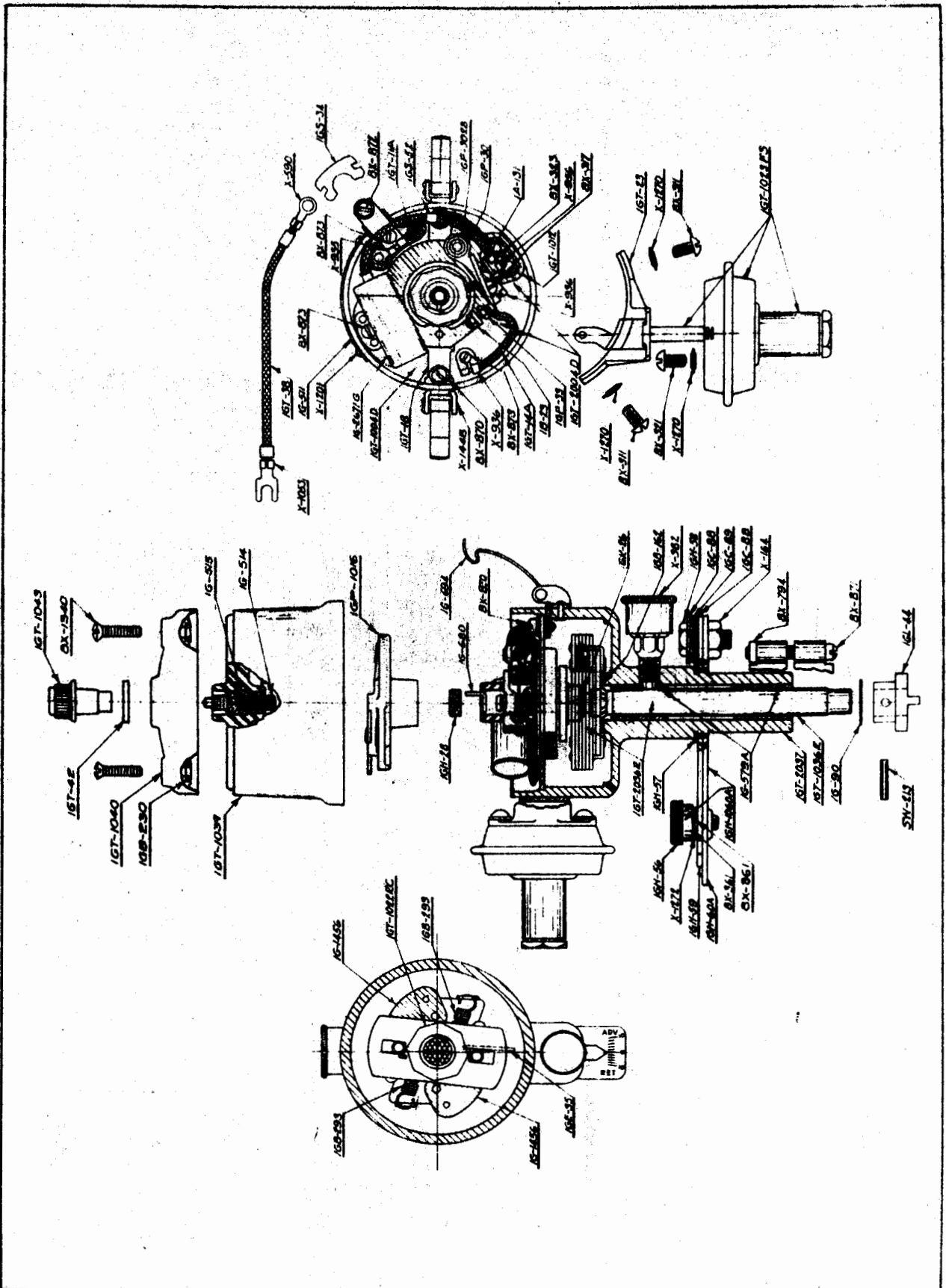

Models 1603-4-5

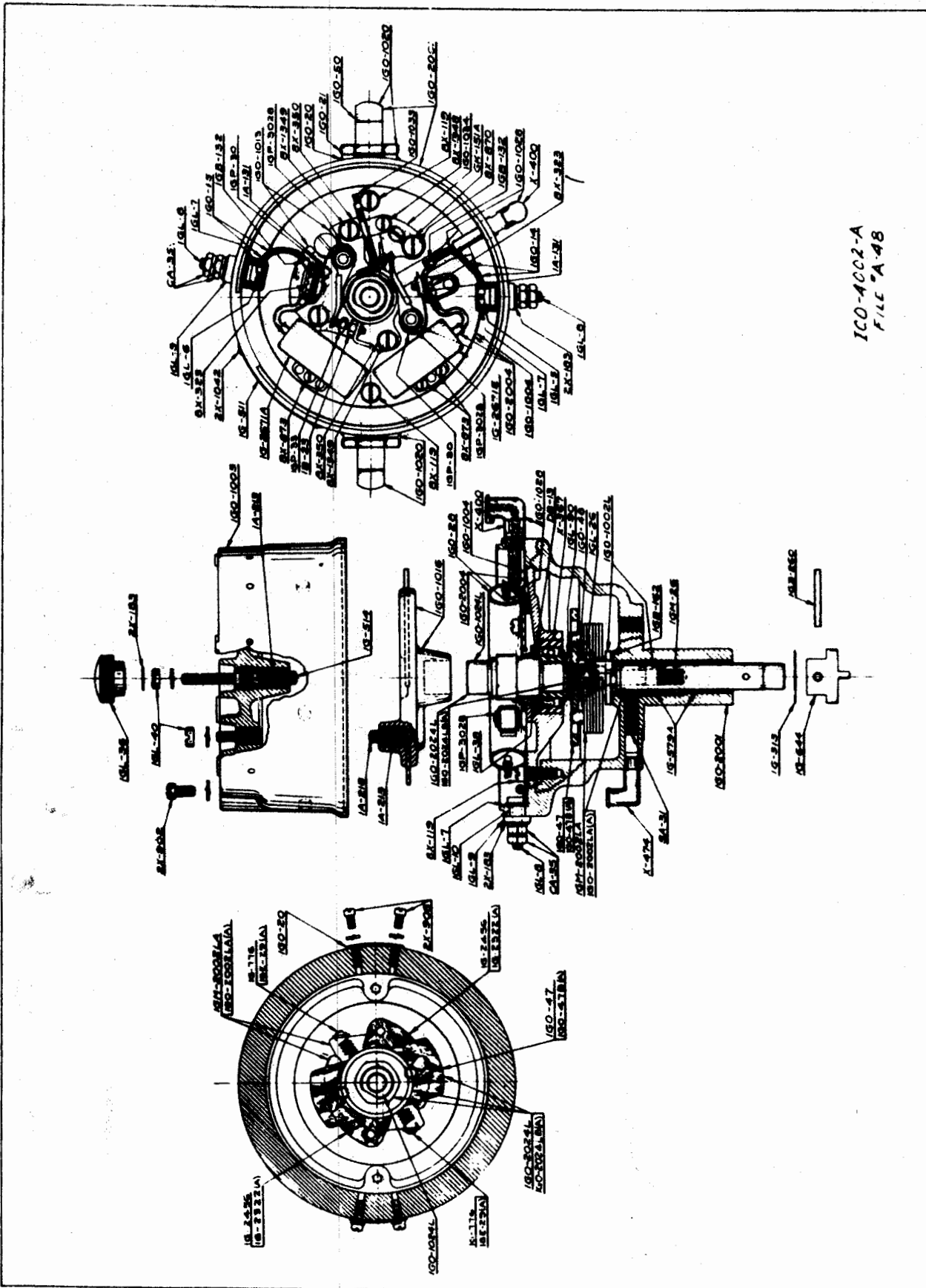

1C0-4002-A
FILE "A" 48

SERVICE PARTS LIST--PACKARD SUPER-EIGHT AND TWELVE

Motor Distributor 109

Piece No.	Name	1500	1506	1603	1607	1707	
		1501	1507	1604	1608	1708	
		1502	1508	1605	No. Required		
IGT-14	Lead assembly	1	-	-	-	-	
IGT-14A	Lead assembly	-	-	1	-	-	
X-936	Terminal	2	-	2	-	-	
8X-317	No. 6-32 x 1/8 rnd. hd. screw	1	-	1	-	-	
X-1012	No. 6 lockwasher	1	-	1	-	-	
8X-323	No. 6-32 x 5/16 rnd. hd. screw	1	-	1	-	-	
8X-873	No. 6-32 x 3/16 fill. hd. screw	3	-	3	-	-	
X-1012	No. 6 lockwasher	4	-	4	-	-	
IGT-2036R	Drive shaft and governor assembly	1	-	1	-	-	
IG-1456	Weight assembly	2	-	2	-	-	
IGB-293	Weight spring	2	-	2	-	-	
IGT-1036R	Drive shaft assembly	1	-	1	-	-	
IGT-2037	Distributor base assembly	1	-	1	-	-	
IG-352	Hinge pin	2	-	-	-	-	
X-1448	Hinge pin	-	-	2	-	-	
IG-511	Name plate	1	-	1	-	-	
IG-579A	Absorbent bronze bearing	2	-	2	-	-	
IG-694	Distributor cap spring	2	-	2	-	-	
X-382	1/8 grease cup	1	-	1	-	-	
X-1201	.10 x 1/4 tubular rivet	2	-	2	-	-	
SW-213	Distributor drive rivet	1	-	1	-	-	
8X-183	No. 10 brass washer	1	-	-	-	-	
X-196	No. 10 lockwasher	2	-	2	-	-	
8X-311	No. 10-32 x 3/8 rnd. hd. screw	2	-	2	-	-	
8X-321	No. 10-32 x 5/16 rnd. hd. screw	2	-	2	-	-	
8X-870	No. 10-32 x 5/16 fill. hd. screw	2	-	2	-	-	
8X-872	No. 10-32 x 1/4 fill. hd. screw	1	-	1	-	-	
X-1270	No. 10 (Shakeproof) washer	6	-	6	-	-	
8X-1340	No. 8-32 x 3/4 countersunk hd. screw	-	-	2	-	-	

MOTOR DISTRIBUTOR
(Electric Auto-Lite No. IGO-4002-A)

The following parts are listed with the manufacturers' piece numbers and are to be ordered by these numbers. Dealers should order these parts through their distributor.

CA-35	No. 10-32 Nut	-	4	-	4	4
IG-313	Shaft thrust washer	-	1	-	1	1
IG-644	Distributor drive coupling	-	1	-	1	1
IGB-162	Thrust washer	-	1	-	1	1
IGB-247	Distributor drive rivet	-	1	-	1	1
IGL-7	Terminal insulation	-	2	-	2	2
IGL-8	Terminal post No. 10-32	-	2	-	2	2
IGL-9	Insulating washer	-	2	-	2	2
IGL-10	Insulating bushing	-	2	-	2	2
IGL-36	Distributor cap nut	-	1	-	1	1
IGL-40	No. 10-32 Nut	-	2	-	2	2
IGM-26	Oil wick	-	1	-	1	1
IGM-2002LA	Drive shaft and governor assembly	-	1	-	1	1

Piece No.	Name	1500	1506	1603	1607	1707	
		1501	1507	1604	1608	1708	
		1502	1508	1605	No. Required		
IGE-29	Weight spring	-	2	-	2	2	
IG-2322	Weight assembly	-	2	-	2	2	
IGO-1002L	Drive shaft assembly	-	1	-	1	1	
IGO-1003	Distributor cap assembly	-	1	-	1	1	
IA-213	Contact spring	-	1	-	1	1	
IG-514	Contact spring plunger	-	1	-	1	1	
IGO-1016	Rotor assembly	-	1	-	1	1	
IA-213	Contact spring	-	1	-	1	1	
IA-218	Contact spring plunger	-	1	-	1	1	
IGO-1028	Oiler assembly	-	1	-	1	1	
IGO-28	Oil wick	-	1	-	1	1	
X-400	3/8 Elbow oiler	-	1	-	1	1	
IGO-1033	Breaker cam oiler	-	1	-	1	1	
IGO-2001	Distributor base assembly	-	1	-	1	1	
IG-511	Name plate	-	1	-	1	1	
IG-579A	Absorbent bronze bearing	-	2	-	2	2	
IGO-1020	Distributor cap spring and bracket assembly.	-	2	-	2	2	
IGO-20	Distributor cap spring bracket	-	2	-	2	2	
IGO-21	Hinge pin	-	2	-	2	2	
IGO-50	Distributor cap spring	-	2	-	2	2	
SA-31	Felt wick	-	1	-	1	1	
X-474	1/4 Oiler--press in elbow	-	1	-	1	1	
2X-908	No. 6-32 x 1/4" fill. hd. screw	-	4	-	4	4	
X-1025	No. 6 Lockwasher	-	4	-	4	4	
2X-1042	No. 13 x 3/16 Escutcheon pin	-	2	-	2	2	
IGO-2004	Breaker plate assembly	-	1	-	1	1	
GK-151A	Plain steel washer	-	1	-	1	1	
IA-131	Breaker arm spring clip	-	2	-	2	2	
IG-2671A	Condenser assembly	-	1	-	1	1	
IG-2671E	Condenser assembly	-	1	-	1	1	
IGO-14	Primary connector assembly	-	1	-	1	1	
IGB-132	Terminal	-	1	-	1	1	
IGL-5	Terminal	-	1	-	1	1	
IGO-15	Primary connector assembly	-	1	-	1	1	
IGB-132	Terminal	-	1	-	1	1	
IGL-6	Terminal	-	1	-	1	1	
IGO-1004	Breaker plate part assembly	-	1	-	1	1	
IGO-1013	Breaker sub-plate assembly	-	1	-	1	1	
IB-23	Breaker point lock nut	-	1	-	1	1	
IGP-33	Breaker point screw	-	1	-	1	1	
IGO-1034	Breaker point	-	1	-	1	1	
IGP-3028	Breaker arm assembly	-	2	-	2	2	
IGP-30	Breaker arm spring	-	2	-	2	2	
X-194	No. 6 Lockwasher	-	2	-	2	2	
X-195	No. 8 Lockwasher	-	2	-	2	2	
8X-323	No. 6-32 x 5/16" rnd. hd. screw	-	2	-	2	2	
8X-350	No. 8 Plain washer	-	2	-	2	2	
X-537	No. 10 Lockwasher	-	1	-	1	1	
8X-870	No. 10-32 x 5/16" fill. hd. screw	-	1	-	1	1	
8X-873	No. 6-32 x 3/16" fill. hd. screw	-	3	-	3	3	
X-1012	No. 6 Lockwasher	-	3	-	3	3	
8X-1349	No. 8-32 x 3/8" fill. hd. screw	-	2	-	2	2	

SERVICE PARTS LIST--PACKARD SUPER-EIGHT AND TWELVE

Motor Flywheel 111

Piece No.	Name	1500	1506	1603	1607	1707	
		1501	1507	1604	1608	1708	
		1502	1508	1605	No. Required		
IGO-2024LB	Breaker cam shaft assembly	-	1	-	1	1	
DB-13	Flat felt guard	-	1	-	1	1	
IGL-26	1/2-20 Nut	-	1	-	1	1	
IGL-38	Felt washer	-	1	-	1	1	
IGL-90	Spacing washer	-	1	-	1	1	
IGO-47B	Stop plate	-	1	-	1	1	
IGO-48	1/2 Special lockwasher	-	1	-	1	1	
IGO-1024L	Cam and shaft	-	1	-	1	1	
X-367	Ball bearing	-	1	-	1	1	
8X-119	No. 10-32 x 1/2" fill. hd. screw	-	2	-	2	2	
2X-183	No. 10 Brass washer	-	3	-	3	3	
X-195	No. 8 Lockwasher	-	1	-	1	1	
X-196	No. 10 Lockwasher	-	20	-	20	20	
8X-350	No. 8 Plain washer	-	1	-	1	1	
2X-902	No. 10-32 x 3/8" fill. hd. screw	-	12	-	12	12	
X-1012	No. 6 Lockwasher	-	1	-	1	1	
8X-1348	No. 6-32 x 5/16" fill. hd. screw	-	1	-	1	1	
8X-1349	No. 8-32 x 3/8" fill. hd. screw	-	1	-	1	1	

MOTOR FAN

207571	Motor fan	1	-	1	-	-
239942	Motor fan	-	-	-	1	1
228675	Motor fan	-	1	-	-	-
209000	Motor fan (Export only)	1	-	1	-	-
7826	Screw 5/16-24 x 5/8 hex. hd.	4	-	-	-	-
5449	Screw 5/16-24 x 3/4 hex. hd.	-	4	4	4	4
3874	Washer 5/16	-	4	4	4	4
5385	Lockwasher 5/16 (Shakeproof)	4	4	4	4	4
237190	Motor fan belt	1	-	1	-	-
239811	Motor fan belt	-	-	-	2	2
237887	Motor fan belt	-	2	-	-	-
4551	Motor fan pulley key No. 5 (Whitney)	1	-	-	-	-
5783	Key No. 7 (Whitney)	-	1	1	1	1
170074	Motor fan pulley nut	1	-	-	-	-
203287	Motor fan pulley nut	-	1	-	-	-
240064	Motor fan pulley nut	-	-	1	1	1
6680	Lockwasher 1/2 (Shakeproof)	1	-	-	-	-
203288	Motor fan pulley nut lock	-	1	1	1	1

MOTOR FLYWHEEL

237297	Motor flywheel assembly	1	-	1	-	-
219808	Motor flywheel assembly	-	1	-	1	1
142020	Motor flywheel flange bolt	6	-	6	-	-
4291	Cotter pin 3/32 x 3/4	6	-	6	-	-
138118	Motor flywheel flange bolt nut	6	-	6	-	-
197260	Motor flywheel flange screw	-	6	-	6	6
5510	Lockwasher 1/2	-	6	-	6	6
219737	Motor flywheel housing	-	1	-	1	1

Piece No.	Name	1500	1506	1603	1607	1707	
		1501	1507	1604	1608	1708	
		1502	1508	1605	No. Required		
197750	Motor flywheel housing to crankcase dowel	-	2	-	2	2	
6049	Motor flywheel housing to crankcase screw 9/16- 18 x 2 hex. hd.	-	2	-	2	2	
5842	Screw 9/16-18 x 3-3/4 hex. hd.	-	4	-	4	4	
7885	Screw 7/16-20 x 1-3/8 hex. hd.	-	3	-	3	3	
5512	Lockwasher 9/16	-	6	-	6	6	
5508	Lockwasher 7/16	-	3	-	3	3	
6437	Motor flywheel housing to oil pan screw 9/16-18 x 4 hex. hd.	-	2	-	2	2	
7009	Nut 9/16-18	-	2	-	2	2	
5512	Lockwasher 9/16	-	2	-	2	2	
197749	Motor flywheel housing timing indicator	-	1	-	1	1	
7801	Screw 1/4-28 x 1/2 hex. hd.	-	2	-	2	2	
5502	Lockwasher 1/4	-	2	-	2	2	
219050	Motor flywheel housing to transmission case stud	-	2	-	2	2	
6022	Stud--long 3/8-24 x 1-3/4	-	6	-	6	6	
6206	Stud 3/8-24 x 1-7/8	-	2	-	2	2	
6106	Stud--short 3/8	-	2	-	2	2	
7006	Nut 3/8-24	-	12	-	12	12	
5506	Lockwasher 3/8	-	12	-	12	12	

MOTOR FUEL PUMP

221006	Motor fuel pump assembly	-	1	-	1	1
232134	Motor fuel pump assembly	1	-	1	-	-
6169	Stud 5/16 x 1-7/16 special	-	2	-	2	2
7005	Nut 5/16-24	-	2	-	2	2
5504	Lockwasher 5/16	-	2	-	2	2
3874	Washer 5/16	-	2	-	2	2
210128	Motor fuel pump bushing	2	-	2	-	-
209339	Motor fuel pump to carburetor tube assembly ...	-	1	-	1	1
232149	Motor fuel pump to carburetor tube assembly ...	1	-	1	-	-
6262	Nut 5/16 flared tube inverted (weatherhead)	-	1	-	1	1
5867	Union nut 5/16 flared tube	-	1	-	1	1
5866	Union nut 5/16 flared tube	2	-	2	-	-
5426	Union connection 5/16 flared tube	1	-	1	-	-
5444	Union connection 5/16 flared tube	-	1	-	1	1
232880	Motor fuel pump to carburetor tube clip (to cylinder)	1	-	1	-	-
225610	Motor fuel pump to carburetor tube insulator ..	-	1	-	-	-
0215177	Motor fuel pump diaphragm spring	-	1	-	1	1
201066	Motor fuel pump eccentric	-	1	-	1	1
3987	Key No. 8 (Whitney)	-	1	-	1	1
207589	Motor fuel pump gasket	2	-	2	-	-
207830	Motor fuel pump gasket	-	1	-	1	1
209332	Motor fuel pump inlet elbow	-	1	-	1	1
239320	Motor fuel pump insulating washer	2	-	2	-	-
210127	Motor fuel pump insulator	1	-	1	-	-
223132	Motor fuel pump operating plunger assembly	1	-	1	-	-

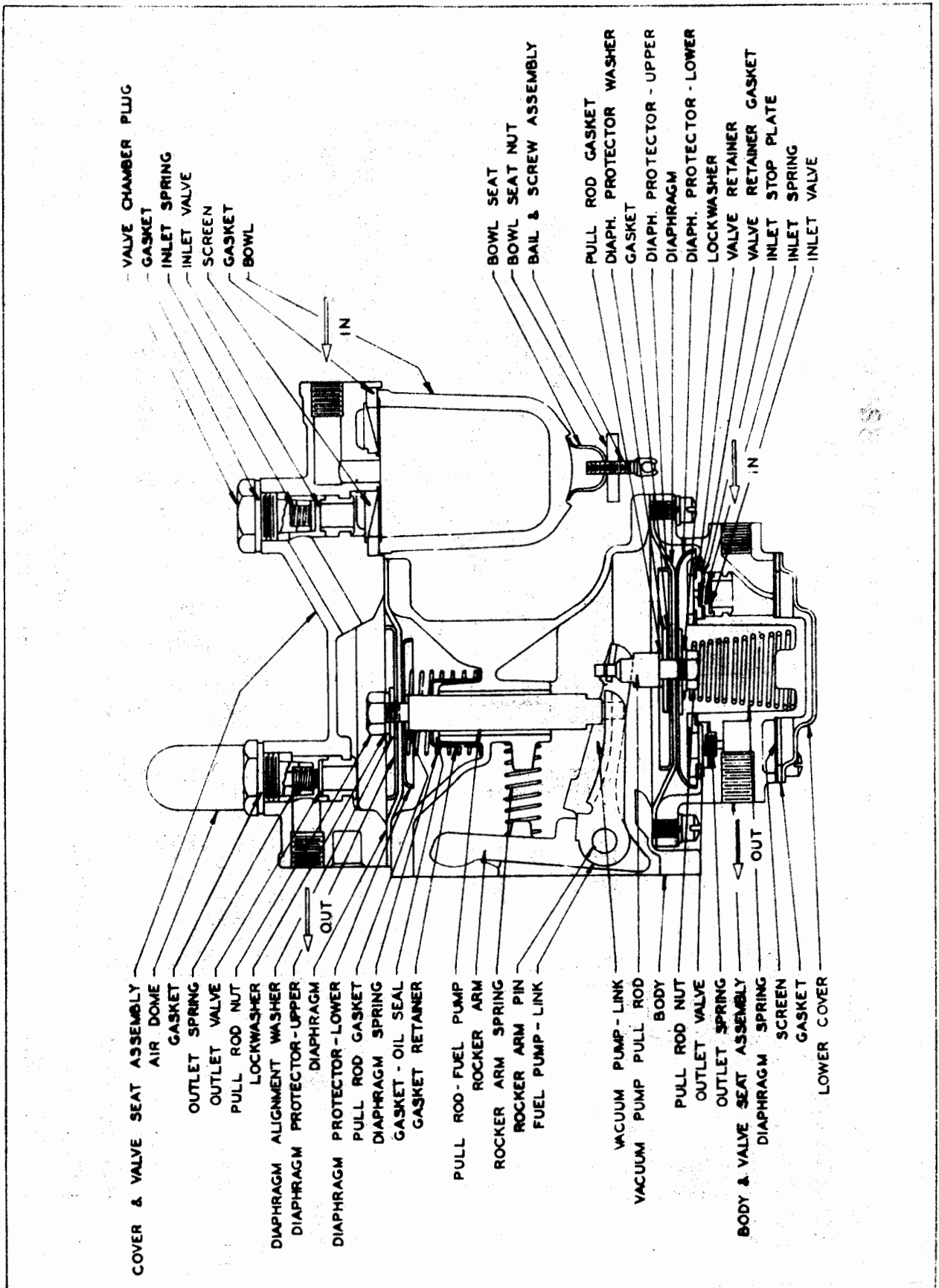

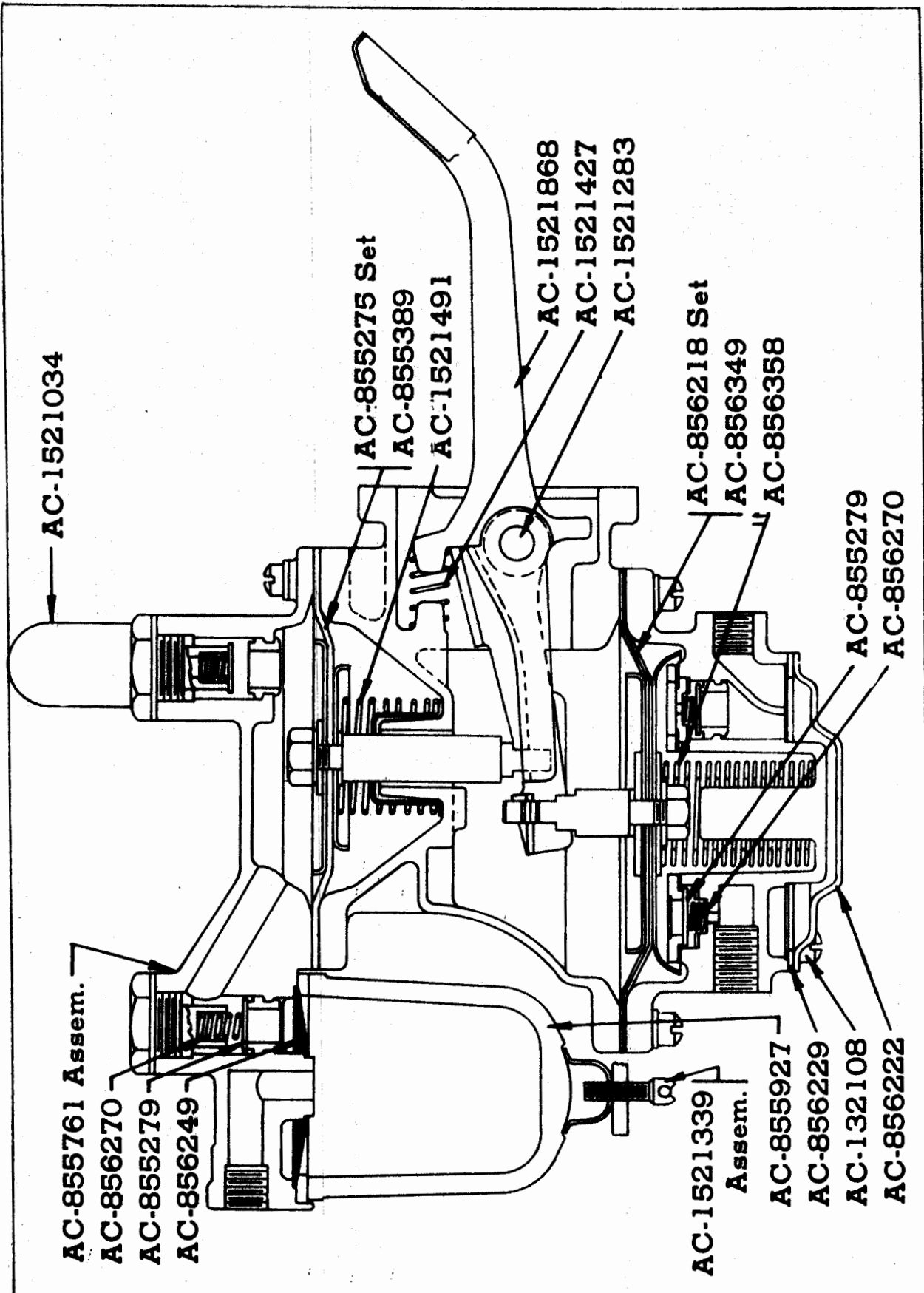

SERVICE PARTS LIST--PACKARD SUPER-EIGHT AND TWELVE

Motor Fuel Pump 115

Piece No.	Name	1500	1506	1603	1607	1707
		1501	1507	1604	1608	1708
		1502	1508	1605	No. Required	

5426	Motor fuel pump outlet connection (union connection 5/16 flared tube)	1	-	1	-	-
6273	Motor fuel pump outlet elbow (5/16 flared tube inverted weatherhead)	-	1	-	1	1

MOTOR FUEL PUMP

The following parts are listed with the manufacturers' piece numbers and are to be ordered by these numbers. Dealers should order these parts through their distributor.

AC-1523196	Combination fuel and vacuum pump	X	-	X	-	-
AC-855282	Valve plug gasket	X	-	X	-	-
AC-856270	Valve spring	X	-	X	-	-
AC-855279	Valve (fuel and vacuum)	X	-	X	-	-
AC-854004	Glass bowl	X	-	X	-	-
AC-854003	Bowl gasket	X	-	X	-	-
AC-856249	Screen	X	-	X	-	-
AC-854005	Bowl seat	X	-	X	-	-
AC-854016	Bail and screw	X	-	X	-	-
AC-855763	Bail thumb nut	X	-	X	-	-
AC-855389	Diaphragm (fuel) (5 pieces)	X	-	X	-	-
AC-1521491	Diaphragm spring (fuel)	X	-	X	-	-
AC-1521755	Rocker arm	X	-	X	-	-
AC-856210	Rocker arm spring	X	-	X	-	-
AC-1522015	Rocker arm pin	X	-	X	-	-
AC-1521284	Rocker arm pin washer	X	-	X	-	-
AC-856209	Oil seal gasket	X	-	X	-	-
AC-856208	Oil seal gasket retainer	X	-	X	-	-
AC-856349	Diaphragm (5 pieces) (vacuum)	X	-	X	-	-
AC-1523692	Diaphragm spring (vacuum)	X	-	X	-	-
AC-1521952	Valve spring (vacuum)	X	-	X	-	-
AC-856229	Bottom cover gasket	X	-	X	-	-
AC-856221	Screen (vacuum)	X	-	X	-	-
AC-855493	Fuel cover and body screw	X	-	X	-	-
AC-855064	Lockwasher (Use with 855493)	X	-	X	-	-
AC-132108	Bottom cover screw	X	-	X	-	-

MOTOR FUEL PUMP

The following parts are listed with the manufacturers' piece numbers and are to be ordered by these numbers. Dealers should order these parts through their distributor.

AC-1521778	Combination pump	-	X	-	X	X
AC-1521034	Air dome	-	X	-	X	X
AC-856354	Body	-	X	-	X	X
AC-855761	Top cover and valve seat assembly	-	X	-	X	X

Piece No.	Name	1500	1506	1603	1607	1707	
		1501	1507	1604	1608	1708	
		1502	1508	1605	No. Required		
AC-1521868	Rocker arm	-	X	-	X	X	
AC-1521283	Rocker arm pin	-	X	-	X	X	
AC-1521284	Rocker arm washer	-	X	-	X	X	
AC-856209	Oil seal gasket	-	X	-	X	X	
AC-856208	Oil seal gasket retainer	-	X	-	X	X	
AC-855493	Top cover screw	-	X	-	X	X	
AC-855064	Top cover screw lockwasher	-	X	-	X	X	
AC-1521866	Link	-	X	-	X	X	
AC-1521036	Valve plug	-	X	-	X	X	
AC-855279	Valve	-	X	-	X	X	
AC-856270	Valve spring	-	X	-	X	X	
AC-855927	Glass bowl	-	X	-	X	X	
AC-854003	Bowl gasket	-	X	-	X	X	
AC-856249	Screen	-	X	-	X	X	
AC-1521339	Bail assembly	-	X	-	X	X	
AC-1521337	Bowl seat	-	X	-	X	X	
AC-1521338	Thumb nut	-	X	-	X	X	
AC-855389	Diaphragm (5 pieces 855275)	-	X	-	X	X	
AC-1521429	Pull rod	-	X	-	X	X	
AC-1521749	Pull rod nut	-	X	-	X	X	
AC-855274	Upper diaphragm protector	-	X	-	X	X	
AC-1521720	Lower diaphragm protector	-	X	-	X	X	
AC-855029	Diaphragm alignment washer	-	X	-	X	X	
AC-855390	Pull rod lockwasher	-	X	-	X	X	
AC-855911	Pull rod gasket	-	X	-	X	X	
AC-1521427	Rocker arm spring	-	X	-	X	X	
AC-1521491	Diaphragm spring	-	X	-	X	X	
AC-1521150	Body	-	X	-	X	X	
AC-855493	Body Screw	-	X	-	X	X	
AC-855064	Body screw lockwasher	-	X	-	X	X	
AC-856349	Diaphragm (5 pieces 856218)	-	X	-	X	X	
AC-856358	Diaphragm spring	-	X	-	X	X	
AC-856216	Upper diaphragm protector	-	X	-	X	X	
AC-856217	Lower diaphragm protector	-	X	-	X	X	
AC-1521156	Diaphragm alignment washer	-	X	-	X	X	
AC-1521097	Gasket	-	X	-	X	X	
AC-1521411	Pull rod	-	X	-	X	X	
AC-1521749	Pull rod nut	-	X	-	X	X	
AC-855390	Pull rod nut lockwasher	-	X	-	X	X	
AC-855911	Pull rod gasket	-	X	-	X	X	
AC-856222	Bottom cover	-	X	-	X	X	
AC-132108	Bottom cover screw	-	X	-	X	X	
AC-856229	Bottom cover gasket	-	X	-	X	X	
AC-855279	Valve	-	X	-	X	X	
AC-856223	Valve stop plate	-	X	-	X	X	
AC-856270	Valve spring	-	X	-	X	X	
AC-856375	Valve retainer	-	X	-	X	X	
AC-856373	Valve retainer gasket	-	X	-	X	X	
AC-856221	Screen	-	X	-	X	X	
AC-856374	Valve retainer screw	-	X	-	X	X	
AC-1521867	Link	-	X	-	X	X	

SERVICE PARTS LIST--PACKARD SUPER-EIGHT AND TWELVE

Motor Gear Cover 117

Piece No.	Name	1500	1506	1603	1607	1707	
		1501	1507	1604	1608	1708	
		1502	1508	1605	No. Required		

MOTOR GASKET SET

0237657	Motor gasket set	1	-	-	-	-
0228773	Motor gasket set	-	1	-	-	-
0239993	Motor gasket set	-	-	1	-	-
0242229	Motor gasket set	-	-	-	1	1

MOTOR GEAR COVER

232027	Motor gear cover assembly	1	-	1	-	-
221003	Motor gear cover	-	1	-	1	1
6015	Stud--short 5/16	8	-	8	-	-
6438	Stud--long 5/16	2	-	2	-	-
7005	Nut 5/16-24	13	-	13	-	-
5504	Lockwasher 5/16	13	-	13	-	-
6020	Screw 5/16-24 x 15/16 hex. hd.	3	-	3	-	-
201865	Motor gear cover stud--long	-	2	-	2	2
197804	Motor gear cover stud--short	-	8	-	8	8
221004	Motor gear cover stud--lower	-	4	-	4	4
3877	Washer 3/8	-	14	-	14	14
5506	Lockwasher 3/8	-	14	-	14	14
7006	Nut 3/8-24	-	14	-	14	14
201053	Motor gear cover gasket	-	1	-	1	1
231319	Motor gear cover gasket	1	-	1	-	-
223747	Motor gear cover motor support bushing	2	2	2	2	2
209763	Motor gear cover motor support bushing plate--front	1	1	1	1	1
209771	Motor gear cover motor support bushing plate--rear	1	-	1	-	-
4454	Motor gear cover motor support bushing plate rivet 1/4 x 1" countersunk head	-	-	3	-	-
5713	Rivet 1/4 x 5/8 countersunk head	-	-	3	-	-
5958	Motor gear cover motor support bushing plate screw 3/8-24 x 13/16 hex. hd.	2	-	2	-	-
5506	Lockwasher 3/8	2	-	2	-	-
6016	Stud 3/8	-	2	-	2	2
7006	Nut 3/8-24	-	2	-	2	2
5506	Lockwasher 3/8	-	2	-	2	2
170522	Motor gear cover oil retainer washer (felt) ...	1	-	1	-	-
170081	Motor gear cover oil retainer washer (steel) ..	1	-	1	-	-
201864	Motor gear cover thrust plate	-	1	-	1	1
232125	Motor gear cover timing indicator	1	-	1	-	-
203198	Motor gear cover timing indicator	-	1	-	1	1
6014	Stud	-	2	-	2	2
7004	Nut 1/4-28	-	2	-	2	2
5502	Lockwasher 1/4	-	2	-	2	2

Piece No.	Name	1500	1506	1603	1607	1707
		1501	1507	1604	1608	1708
		1502	1508	1605	No. Required	

MOTOR GENERATOR

237137	Motor generator (Delco)	1	-	-	-	-
237166	Motor generator (Delco)	-	1	-	-	-
239537	Motor generator (Auto-Lite) (6 Volt)	1	-	1	-	-
239533	Motor generator (Auto-Lite)	-	1	-	1	1
242057	Motor generator (Auto-Lite) (12 Volt)	-	-	1	-	-
237139	Motor generator adjusting strap	1	-	1	-	-
5483	Motor generator adjusting strap to gear cover screw 5/16-24 x 3/4 hex. hd.	1	-	1	-	-
5385	Lockwasher 5/16 (Shakeproof)	1	-	1	-	-
7005	Nut 5/16-24	1	-	1	-	-
6061	Motor generator adjusting strap to generator screw 5/16-18 x 7/8 hex. hd.	1	-	1	-	-
6228	Washer 5/16 special	1	-	1	-	-
5385	Lockwasher 5/16 (Shakeproof)	1	-	1	-	-
234684	Motor generator bracket and screw boss assembly	1	-	1	-	-
5577	Motor generator to bracket screw 5/16-24 x 7/8 hex. hd.	2	-	1	-	-
6087	Screw 5/16-24 x 1 hex. hd.	-	-	1	-	-
3909	Motor generator to bracket rear screw spacer ..	-	-	1	-	-
5385	Lockwasher 3/16 (Shakeproof)	2	-	2	-	-
221042	Motor generator to gear cover stud	-	1	-	1	1
7008	Nut 1/2-20	-	1	-	1	1
6047	Lockwasher 1/2 (Shakeproof) extra heavy ..	-	1	-	1	1
3884	Washer 1/2	-	1	-	1	1
219895	Motor generator to gear cover stud washer	-	1	-	1	1
219893	Motor generator to gear cover screw--long	-	1	-	1	1
5510	Lockwasher 1/2	-	1	-	1	1

MOTOR GENERATOR

(Delco Type No. 961-J)

The following parts are listed with the manufacturers' piece numbers and are to be ordered by these numbers. Dealers should order these parts through their distributor.

D-1866114	Frame and field assembly	x	-	-	-	-
D-1849756	Pole shoe	x	-	-	-	-
D-828675	Pole shoe screw	x	-	-	-	-
D-1858754	Terminal stud and lead assembly	x	-	-	-	-
D-1858749	Terminal stud only (and bushing)	x	-	-	-	-
D-1858753	Terminal stud insulator washer	x	-	-	-	-
D-1858752	Terminal stud plain washer	x	-	-	-	-
D-1843522	Terminal stud nut	x	-	-	-	-
D-802757	Terminal stud nut lockwasher	x	-	-	-	-
D-1857107	Terminal clip (to brush)	x	-	-	-	-
D-1866144	Field coil (R.H. to brush)	x	-	-	-	-
D-1866145	Field coil (L.H. to "F" terminal)	x	-	-	-	-
D-1857866	Armature	x	-	-	-	-

SERVICE PARTS LIST--PACKARD SUPER-EIGHT AND TWELVE

Motor Generator 119

Piece No.	Name	1500	1506	1603	1607	1707	
		1501	1507	1604	1608	1708	
		1502	1508	1605	No. Required		
D-816340	Commutator cover band	x	-	-	-	-	
D-1866118	Commutator end frame assembly	x	-	-	-	-	
D-812823	Bushing (C.E.)	x	-	-	-	-	
D-809062	Dowel pin (C.E.)	x	-	-	-	-	
D-113702	Oiler (C.E.)	x	-	-	-	-	
D-804076	Oilewick (C.E.)	x	-	-	-	-	
D-816315	Oil hole plug (C.E.)	x	-	-	-	-	
D-1860380	Brush plate	x	-	-	-	-	
D-115434	Brush plate attaching screw	x	-	-	-	-	
D-141551	Brush plate attaching screw lockwasher	x	-	-	-	-	
D-1860344	Brush	x	-	-	-	-	
D-1850760	Brush spring	x	-	-	-	-	
D-1850759	Brush arm	x	-	-	-	-	
D-1857412	Brush arm space washer	x	-	-	-	-	
D-802730	Brush lead attaching screw lockwasher	x	-	-	-	-	
D-141541	Brush lead attaching screw	x	-	-	-	-	
D-820524	End cover plate (C.E.)	x	-	-	-	-	
D-817220	End cover plate gasket (C.E.)	x	-	-	-	-	

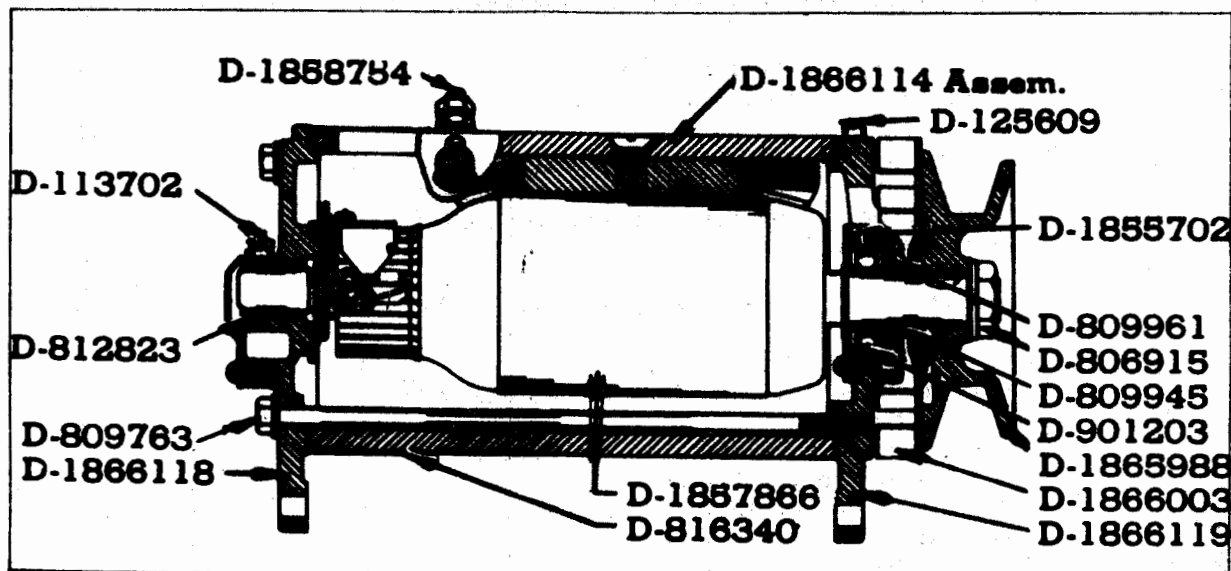

Models 1500-1-2

Piece No.	Name	1500	1506	1603	1607	1707	
		1501	1507	1604	1608	1708	
		1502	1508	1605	No. Required		
D-115607	End cover plate screw (C.E.)	x	-	-	-	-	
D-802729	End cover plate screw lockwasher (C.E.)	x	-	-	-	-	
D-1866119	Drive end frame	x	-	-	-	-	
D-125609	Oiler (D.E.)	x	-	-	-	-	
D-1858603	Space collar (outside D.E.)	x	-	-	-	-	
D-809945	Space washer (inside D.E.)	x	-	-	-	-	
D-809961	Felt washer (D.E.)	x	-	-	-	-	
D-819104	Felt washer retainer plate (D.E.)	x	-	-	-	-	
D-901203	Ball bearing (D.E.)	x	-	-	-	-	
D-1855702	Ball bearing retainer plate (D.E.)	x	-	-	-	-	
D-1855701	Ball bearing retainer plate gasket (D.E.)	x	-	-	-	-	
D-115431	Ball bearing retainer plate screw (D.E.)	x	-	-	-	-	
D-802731	Ball bearing retainer plate screw (D.E.)	x	-	-	-	-	
D-809593	Dowel pin (D.E.)	x	-	-	-	-	
D-103905	Woodruff key (D.E.)	x	-	-	-	-	
D-806915	Shaft nut (D.E.)	x	-	-	-	-	
D-804000	Shaft nut lockwasher (D.E.)	x	-	-	-	-	
D-1866003	Fan	x	-	-	-	-	
D-1865988	Pulley	x	-	-	-	-	
D-809763	Thru bolt	x	-	-	-	-	
D-141555	Thru bolt lockwasher	x	-	-	-	-	
D-115353	Control unit ground lead screw	x	-	-	-	-	
D-141553	Control unit ground lead screw lockwasher	x	-	-	-	-	

MOTOR GENERATOR - 6 VOLT
(Electric Auto-Lite No. GCO-4803-A)

The following parts are listed with the manufacturers' piece numbers and are to be ordered by these numbers. Dealers should order these parts through their distributor.

Frame and Field Assembly and Parts Used With

GCO-20B	Frame screw	2	-	2	-	-
GBW-66	Terminal post button ins. (Supersedes GAA-30)	1	-	1	-	-
GAA-31	Insulating bushing	1	-	-	-	-
GCT-25	Insulating bushing	-	-	1	-	-
GAA-32	Terminal post top insulation	1	-	1	-	-
GAL-44	Field connection insulation	1	-	1	-	-
GBF-54	Insulating bushing	1	-	-	-	-
GCY-25	Insulating bushing	-	-	1	-	-
GBW-67	Terminal post insulation (Supersedes GBW-33)	1	-	1	-	-
GBW-34	Insulating washer	1	-	1	-	-
GBW-40	Lead assembly	1	-	1	-	-
GAA-27	Terminal post	1	-	1	-	-
X-847	Terminal	1	-	1	-	-
GBW-58	Terminal post	1	-	1	-	-
GCO-29	Pole piece	2	-	2	-	-
GCO-1005	Field coil assembly--comp.	1	-	1	-	-
GCO-1007	Field coil assembly--left	1	-	1	-	-

SERVICE PARTS LIST--PACKARD SUPER-EIGHT AND TWELVE

Motor Generator 121

Piece No.	Name	1500	1506	1603	1607	1707
		1501	1507	1604	1608	1708
		1502	1508	1605	No. Required	
IG-821	Terminal	1	-	1	-	-
GCO-1008	Field coil--right	1	-	1	-	-
GK-38A	Pole piece screw	2	-	2	-	-
MN-21	Dowel pin	2	-	2	-	-
2X-177	No. 14-24 hex. nut	1	-	1	-	-
12X-193	No. 14 lockwasher	1	-	1	-	-
12X-196	No. 10 lockwasher	1	-	1	-	-
2X-349	No. 10 plain washer	1	-	1	-	-
2X-361	1/2 plain washer	1	-	1	-	-
2X-1377	No. 10-32 hex. nut	1	-	1	-	-
2X-177	No. 14-24 hex. nut	1	-	1	-	-
12X-193	No. 14 lockwasher	1	-	1	-	-
12X-196	No. 10 lockwasher	2	-	2	-	-
12X-199	1/4 lockwasher	2	-	2	-	-
2X-321	No. 10-32 x 5/16 rnd. hd. screw	1	-	1	-	-
2X-1377	No. 10-32 hex. nut	1	-	1	-	-

**Commutator End Plate Assembly
and Parts Used With**

GAR-73	Oil wick	1	-	1	-	-
GAR-98B	Wick cover	1	-	1	-	-
GBW-30B	Commutator end cap cover	1	-	1	-	-
GBW-31	Gasket	1	-	1	-	-
GBW-32	Oil guard	1	-	1	-	-
GBW-1002C	Commutator end plate part assembly	1	-	1	-	-
GEF-79	Absorbent bronze bearing	1	-	1	-	-
GBW-2012AS	Brush set	1	-	1	-	-
GBW-45	Brush spring	2	-	2	-	-
GCJ-26	Brush arm	2	-	2	-	-
GBW-1012A	Brush--main	2	-	2	-	-
12X-195	No. 8 lockwasher	5	-	5	-	-
2X-305	No. 8-32 x 1/4 rnd. hd. screw	1	-	1	-	-
X-489	1/4 oiler--press in type	1	-	1	-	-
2X-888	No. 8-32 x 5/16 fill. hd. screw	4	-	4	-	-
X-195	No. 8 lockwasher	1	-	1	-	-
8X-305	No. 8-32 x 1/4 rnd. hd. screw	1	-	1	-	-

Armature Assembly and Parts Used With

GBM-21A	Armature shaft nut	1	-	1	-	-
GCO-2006F	Armature assembly	1	-	1	-	-
GAR-171	Snap ring	1	-	1	-	-
GR-32	Felt washer retainer	1	-	1	-	-
SP-260	Drive pulley	1	-	1	-	-
X-260	No. 5 Woodruff key	1	-	1	-	-
X-864	.669 lockwasher	1	-	1	-	-

122 Motor Generator

SERVICE PARTS LIST--PACKARD SUPER-EIGHT AND TWELVE

Piece No.	Name	1500	1506	1603	1607	1707
		1501	1507	1604	1608	1708
		1502	1508	1605	No. Required	

Drive End Head Assembly and Parts Used With

GAR-1198	Drive end head assembly	1	-	1	-	-
GAR-63	Felt guard	2	-	2	-	-
GAR-64	Bearing retainer	2	-	2	-	-
GAR-198	Drive end head	1	-	1	-	-
GG-164	Felt washer	2	-	2	-	-
8X-173	No. 10-32 hex. nut	3	-	3	-	-
X-196	No. 10 lockwasher	3	-	3	-	-
X-295	Ball bearing--S.A.E. No. 203	1	-	1	-	-
X-489	1/4 oiler--Press in type	1	-	1	-	-
8X-1003	No. 10-32 x 7/8 rnd. hd. screw	3	-	3	-	-

Miscellaneous Parts

GBW-24C	Head band	1	-	1	-	-
2X-715	No. 10-32 x 1-1/4 rnd. hd. screw	1	-	1	-	-
2X-794	No. 10-32 square nut	1	-	1	-	-

MOTOR GENERATOR - 12 VOLT
(Auto-Lite No. GCR-4803-A)

The following parts are listed with the manufacturers' piece numbers and are to be ordered by these numbers. Dealers should order these parts through their distributor.

Frame and Field Assembly

GAA-30	Terminal post bottom insulation	-	-	1	-	-
GAA-32	Terminal post top insulation	-	-	1	-	-
GAL-44	Field connection insulation	-	-	1	-	-
GBW-33	Terminal post insulation	-	-	1	-	-
GBW-34	Insulating washer	-	-	1	-	-
GBW-40	Lead assembly	-	-	1	-	-
GAA-27	Terminal post	-	-	1	-	-
X-847	Terminal	-	-	1	-	-
GBW-58	Terminal post	-	-	1	-	-
GCO-29	Pole piece	-	-	2	-	-
GCR-1005	Field coil assembly--comp.	-	-	1	-	-
GCR-1007	Field coil assembly--left	-	-	1	-	-
IG-821	Terminal	-	-	1	-	-
GCR-1008	Field coil--right	-	-	1	-	-
GCT-25	Insulating bushing	-	-	1	-	-
GCY-25	Insulating bushing	-	-	1	-	-
GK-38A	Pole piece screw	-	-	2	-	-
MN-21	Dowel pin	-	-	2	-	-
2X-177	No. 14-24 hex. nut	-	-	1	-	-
12X-193	No. 14 lockwasher	-	-	1	-	-
12X-196	No. 10 lockwasher	-	-	1	-	-

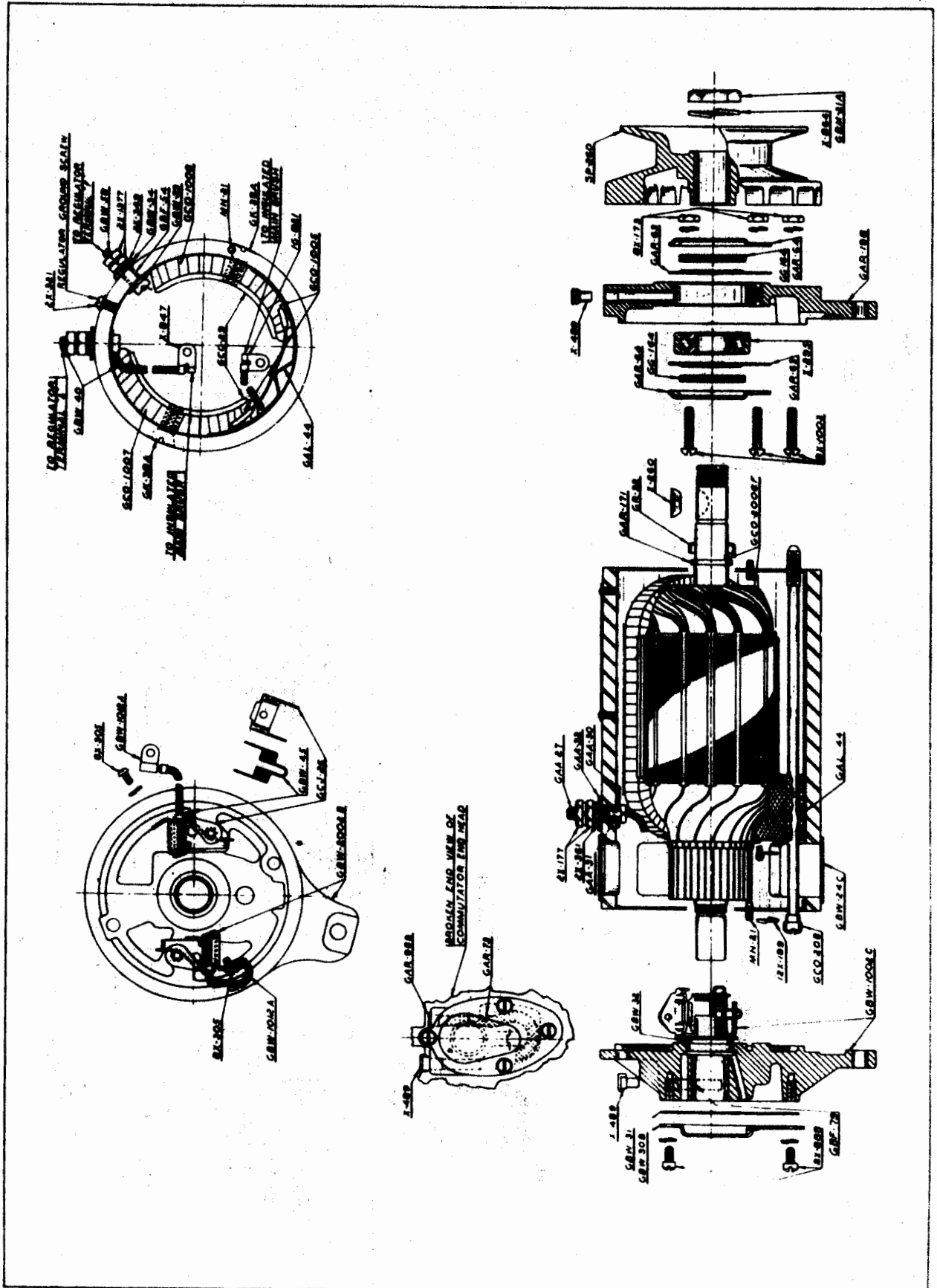

Models 1500-1-2, 1603-4-5 (6 Volt)

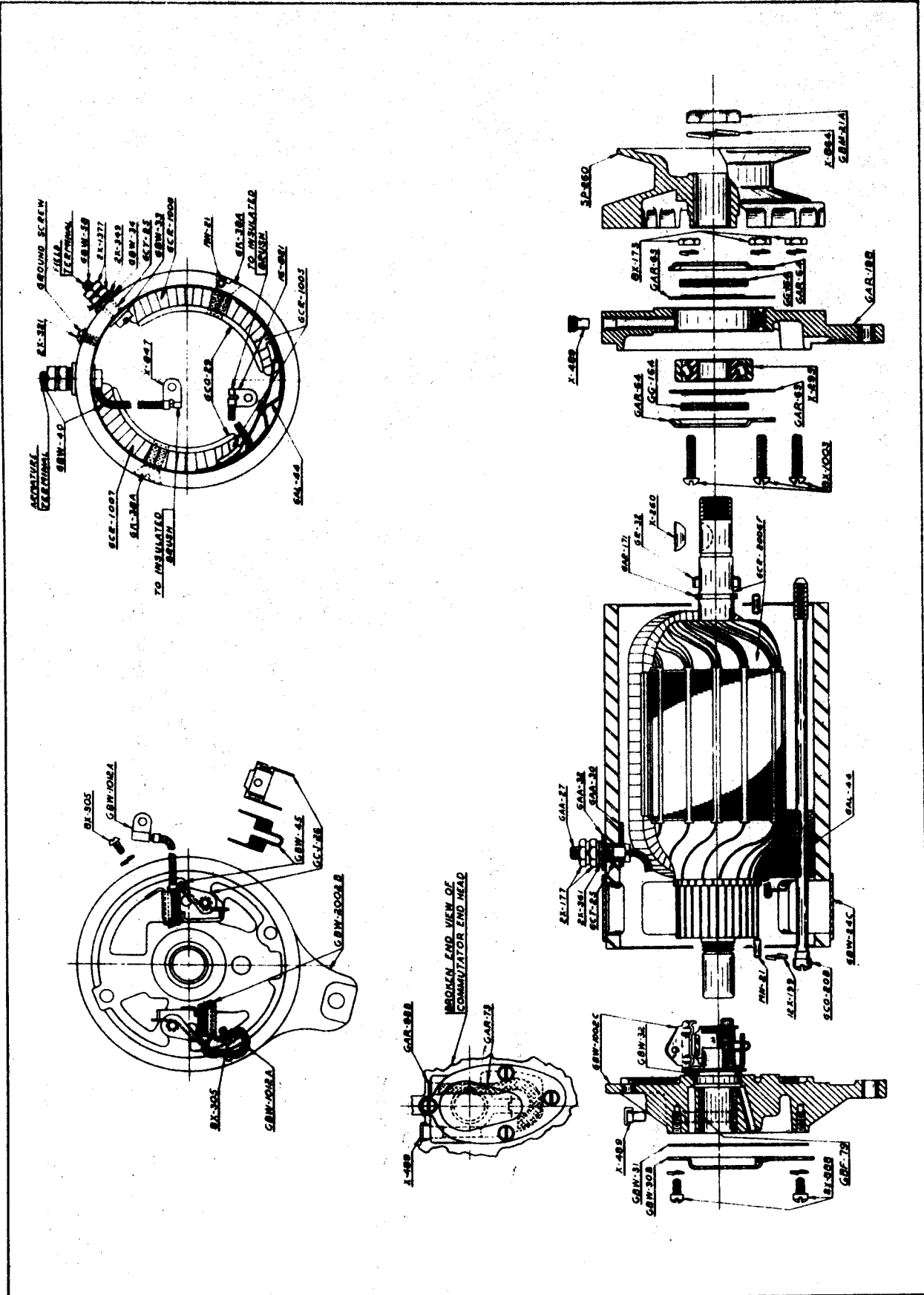

Models 1603-4-5 (12 Volt)

LITHOGRAPHED IN U S A

SERVICE PARTS LIST--PACKARD SUPER-EIGHT AND TWELVE

Motor Generator 125

Piece No.	Name	1500	1506	1603	1607	1707	
		1501	1507	1604	1608	1708	
		1502	1508	1605	No. Required		
2X-349	No. 10 plain washer	-	-	1	-	-	
2X-361	1/4 plain washer	-	-	1	-	-	
2X-1377	No. 10-32 hex. nut	-	-	1	-	-	
GCO-20B	Frame screw	-	-	2	-	-	
2X-177	No. 14-24 hex. nut	-	-	1	-	-	
12X-193	No. 14 lockwasher	-	-	1	-	-	
12X-196	No. 10 lockwasher	-	-	2	-	-	
12X-199	1/4 lockwasher	-	-	2	-	-	
2X-321	No. 10-32 x 5/16 rnd. hd. screw	-	-	1	-	-	
2X-1377	No. 10-32 hex. nut	-	-	1	-	-	
Commutator End Plate Assembly							
GAR-73	Oil wick	-	-	1	-	-	
GAR-98B	Wick cover	-	-	1	-	-	
GBW-30B	Commutator end cap cover	-	-	1	-	-	
GBW-31	Gasket	-	-	1	-	-	
GBW-32	Oil guard	-	-	1	-	-	
GBW-1002C	Commutator end plate part assembly	-	-	1	-	-	
GBF-79	Absorbent bronze bearing	-	-	1	-	-	
GBW-45	Brush spring	-	-	2	-	-	
GCJ-26	Brush arm	-	-	2	-	-	
GBW-1012A	Brush main	-	-	2	-	-	
12X-195	No. 8 lockwasher	-	-	5	-	-	
2X-305	No. 8-32 x 1/4 rnd. hd. screw	-	-	1	-	-	
X-489	1/4 oiler--press in type	-	-	1	-	-	
2X-888	No. 8-32 x 5/16 fill. hd. screw	-	-	4	-	-	
X-195	No. 8 lockwasher	-	-	1	-	-	
8X-305	No. 8-32 x 1/4 rnd. hd. screw	-	-	1	-	-	
Armature Assembly and Parts Used With							
GBM-21A	Armature shaft nut	-	-	1	-	-	
GCR-2006F	Armature assembly	-	-	1	-	-	
GAR-171	Snap ring	-	-	1	-	-	
GR-32	Felt washer retainer	-	-	1	-	-	
SP-260	Drive pulley	-	-	1	-	-	
X-260	No. 5 Woodruff key	-	-	1	-	-	
X-864	.669 lockwasher	-	-	1	-	-	
Drive End Head Assembly and Parts Used With							
GAR-1198	Drive end head assembly	-	-	1	-	-	
GAR-63	Felt guard	-	-	2	-	-	
GAR-64	Bearing retainer	-	-	2	-	-	
GAR-198	Drive end head	-	-	1	-	-	
GG-164	Felt washer	-	-	2	-	-	
8X-173	No. 10-32 hex. nut	-	-	3	-	-	
X-196	No. 10 lockwasher	-	-	3	-	-	

Piece No.	Name	1500	1506	1603	1607	1707
		1501	1507	1604	1608	1708
		1502	1508	1605	No. Required	
X-295	Ball bearing--S.A.E. No. 203	-	-	1	-	-
X-489	1/4 oiler--press in type	-	-	1	-	-
8X-1003	No. 10-32 x 7/8 rnd. hd. screw	-	-	3	-	-

Miscellaneous Parts

GBW-24C	Head band	-	-	1	-	-
2X-715	No. 10-32 x 1-1/4 rnd. hd. screw	-	-	1	-	-
2X-794	No. 10-32 square nut	-	-	1	-	-

MOTOR GENERATOR
(Delco-Type No. 930-F)

The following parts are listed with the manufacturers' piece numbers and are to be ordered by these numbers. Dealers should order these parts through their distributor.

D-1866062	Frame and field assembly	-	X	-	-	-
D-812287	Pole shoe	-	X	-	-	-
D-1866065	Pole shoe screw	-	X	-	-	-
D-1861540	Field coil (R.H. to brush)	-	X	-	-	-
D-1861541	Field coil (L.H. to "F" terminal)	-	X	-	-	-
D-1858749	Terminal stud and bushing	-	X	-	-	-
D-1858753	Terminal stud insulating washer	-	X	-	-	-
D-1866068	Terminal stud plain washer	-	X	-	-	-
D-1866066	Terminal stud nut	-	X	-	-	-
D-1866067	Terminal stud nut lockwasher	-	X	-	-	-
D-1857107	Terminal clip (to brush)	-	X	-	-	-
D-1866069	Armature	-	X	-	-	-
D-1835646	Commutator cover band	-	X	-	-	-
D-1863767	Comutator end frame	-	X	-	-	-
D-1857213	Brush plate	-	X	-	-	-
D-115431	Brush plate attaching screw	-	X	-	-	-
D-141552	Brush plate attaching screw lockwasher	-	X	-	-	-
D-1856494	Brush	-	X	-	-	-
D-1850760	Brush spring	-	X	-	-	-
D-1850759	Brush arm	-	X	-	-	-
D-1857412	Brush arm space washer	-	X	-	-	-
D-141541	Brush lead attaching screw	-	X	-	-	-
D-802730	Brush lead attaching screw lockwasher	-	X	-	-	-
D-113702	Oiler (C.E. and D.E.)	-	X	-	-	-
D-29047	Oil wick (C.E.)	-	X	-	-	-
D-903503	Ball bearing (C.E.)	-	X	-	-	-
D-1861547	End cover plate (C.E.)	-	X	-	-	-
D-1835457	End cover plate gasket (C.E.)	-	X	-	-	-
D-115898	End cover plate screw (C.E.)	-	X	-	-	-
D-115693	End cover plate screw lockwasher (C.E.)	-	X	-	-	-
D-1866072	Drive end frame	-	X	-	-	-
D-1866074	Felt washer (D.E.)	-	X	-	-	-

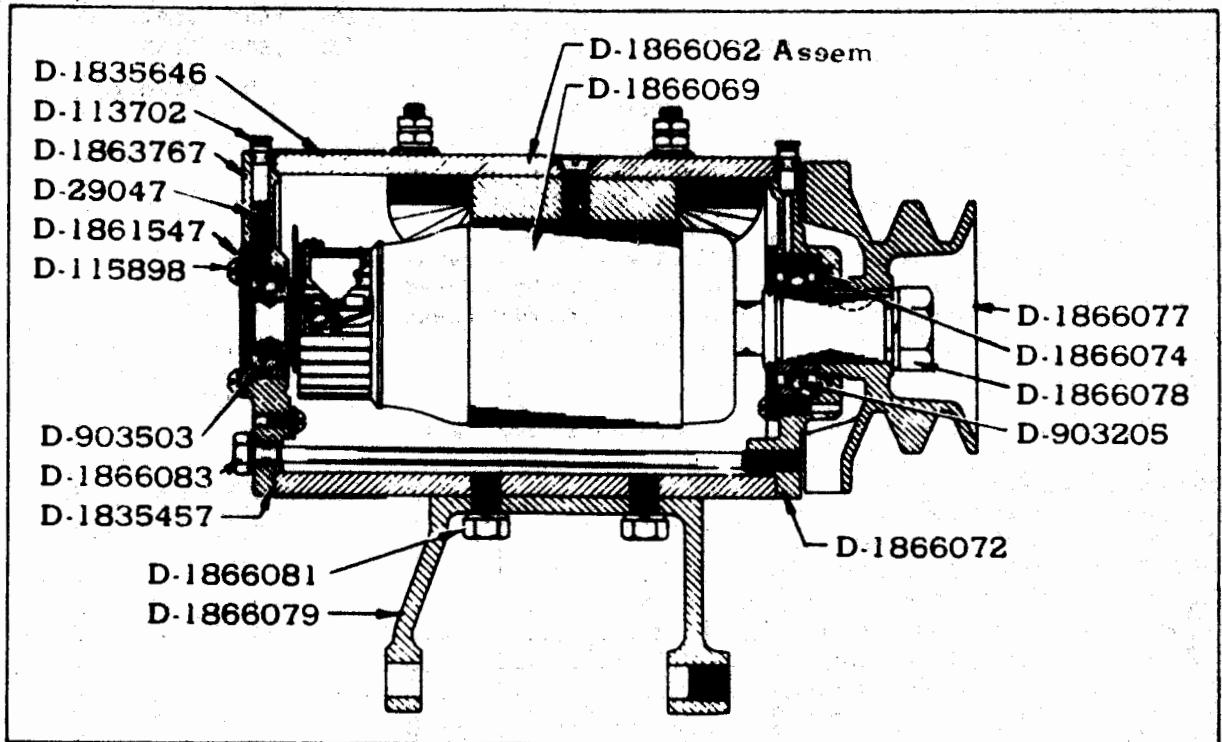

Model 1506-7-8

Piece No.	Name	1500	1506	1603	1607	1707
		1501	1507	1604	1608	1708
		1502	1508	1605	No. Required	
D-1866073	Felt washer retainer cup (D.E.)	-	x	-	-	-
D-903205	Ball bearing (D.E.)	-	x	-	-	-
D-1866075	Ball bearing retainer plate (D.E.)	-	x	-	-	-
D-1866076	Ball bearing retainer plate gasket (D.E.)	-	x	-	-	-
D-115431	Ball bearing retainer plate screw (D.E.)	-	x	-	-	-
D-802731	Ball bearing retainer plate screw L.W. (D.E.)	-	x	-	-	-
D-103906	Woodruff key (D.E.)	-	x	-	-	-
D-1866078	Shaft nut (D.E.)	-	x	-	-	-
D-115554	Shaft nut lockwasher (D.E.)	-	x	-	-	-
D-1866077	Pulley	-	x	-	-	-
D-1866083	Thru bolt	-	x	-	-	-
D-144549	Thru bolt lockwasher	-	x	-	-	-
D-144552	Screw (top to field frame)	-	x	-	-	-
D-116131	Lockwasher (top of field frame)	-	x	-	-	-
D-1866079	Generator mounting bracket	-	x	-	-	-
D-1866080	Generator mounting bracket screw (flat head)	-	x	-	-	-
D-1866081	Generator mounting bracket screw (hex. head)	-	x	-	-	-
D-1866082	Generator mounting bracket screw lockwasher.	-	x	-	-	-

Piece No.	Name	1500	1506	1603	1607	1707	
		1501	1507	1604	1608	1708	
		1502	1508	1605	No. Required		

MOTOR GENERATOR
(Electric Auto-Lite No. GCE-4803-A)

The following parts are listed with the manufacturers' piece numbers and are to be ordered by these numbers. Dealers should order these parts through their distributor.

Frame and Field Assembly and Parts Used With

GCE-20	Frame screw	-	2	-	2	2
GCE-33	Mounting bracket	-	1	-	1	1
GAA-31	Insulating bushing	-	1	-	-	-
GCT-25	Insulating bushing	-	-	-	1	1
GAA-32	Terminal post top insulation	-	1	-	1	1
GAL-44	Field connection insulation	-	1	-	1	1
GBF-54	Insulating bushing	-	1	-	-	-
GCY-25	Insulating bushing	-	-	-	1	1
GBW-34	Insulating washer	-	1	-	1	1
GBW-58	Terminal post	-	1	-	1	1
GBX-29	Pole piece	-	2	-	2	2
GBY-38B	Pole piece screw	-	2	-	2	2
GBW-66	Terminal post bottom insulation	-	1	-	1	1
GBW-67	Terminal post insulation (Supersedes GCE-28)	-	1	-	1	1
GCE-1005	Field coil assembly--comp.	-	1	-	1	1
GCE-1007	Field coil assembly--left	-	1	-	1	1
GCE-26	Control lead	-	1	-	1	1
GCE-34	Terminal post	-	1	-	1	1
X-847	Terminal	-	1	-	1	1
IG-821	Terminal	-	1	-	1	1
GCE-1008	Field coil--right	-	1	-	1	1
MN-21	Dowel pin	-	2	-	2	2
2X-177	No. 14-24 hex. nut	-	1	-	1	1
12X-193	No. 14 lockwasher	-	1	-	1	1
12X-196	No. 10 lockwasher	-	1	-	1	1
2X-349	No. 10 plain washer	-	1	-	1	1
2X-361	1/4 plain washer	-	1	-	1	1
2X-1377	No. 10-32 hex. nut	-	1	-	1	1
2X-177	No. 14-24 hex. nut	-	1	-	1	1
12X-193	No. 14 lockwasher	-	1	-	1	1
12X-196	No. 10 lockwasher	-	2	-	2	2
X-262	No. 7 Woodruff key	-	1	-	1	1
2X-321	No. 10-32 x 5/16 rnd. hd. screw	-	1	-	1	1
2X-1174	5/16-24 x 1/2 flat hd. screw	-	4	-	4	4
2X-1377	No. 10-32 hex. nut	-	1	-	1	1

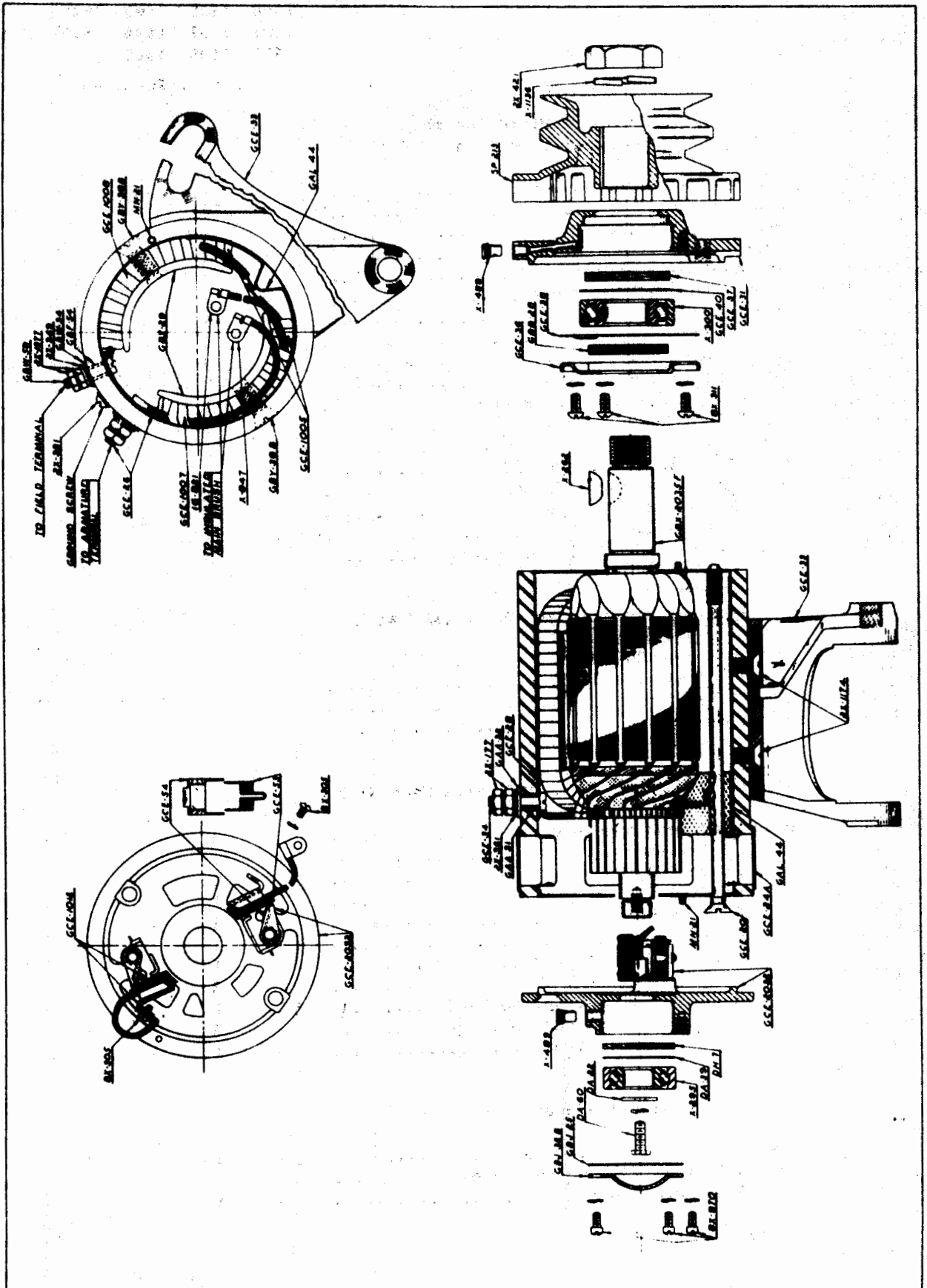

Models 1506-7-8, 1607-8, 1707-8

Piece No.	Name	1500	1506	1603	1607	1707
		1501	1507	1604	1608	1708
		1502	1508	1605	No. Required	
Commutator End Plate Assembly and Parts Used With						
DA-22	Bearing retaining washer	-	1	-	1	1
DA-39	Flat oil guard	-	1	-	1	1
DA-60	Bearing retaining screw	-	1	-	1	1
DH-7	Felt washer	-	1	-	1	1
GBJ-25	End cap cover gasket	-	1	-	1	1
GBJ-32B	Commutator end cap cover	-	1	-	1	1
GCE-53	Brush spring	-	2	-	2	2
GCE-54	Brush arm	-	2	-	2	2
GCE-1012	Brush—main	-	2	-	2	2
X-195	No. 8 lockwasher	-	1	-	1	1
8X-305	No. 8-32 x 1/4 rnd. hd. screw	-	1	-	1	1
X-195	No. 8 lockwasher	-	1	-	1	1
X-199	1/4 lockwasher	-	1	-	1	1
X-295	Ball bearing—S.A.E. No. 203	-	1	-	1	1
8X-305	No. 8-32 x 1/4 rnd. hd. screw	-	1	-	1	1
X-489	1/4 oiler—press in type	-	1	-	1	1
12X-544	No. 10 lockwasher	-	3	-	3	3
2X-870	No. 10-32 x 5/16 fill. hd. screw	-	3	-	3	3
Armature Assembly and Parts Used With						
GBX-2035F	Armature assembly	-	1	-	1	1
SP-213	Drive pulley	-	1	-	1	1
2X-421	7/8-14 hex. nut	-	1	-	1	1
X-1136	7/8 lockwasher	-	1	-	1	1
Drive End Head Assembly and Parts Used With						
GCE-1031	Drive end head assembly	-	1	-	1	1
GBB-28	Felt washer	-	1	-	1	1
GCE-31	Drive end head	-	1	-	1	1
GCE-36	Bearing retainer	-	1	-	1	1
GCE-37	Felt washer	-	1	-	1	1
GCE-38	Felt guard	-	1	-	1	1
GCE-40	Felt washer retainer	-	1	-	1	1
X-196	No. 10 lockwasher	-	3	-	3	3
X-300	Ball bearing—S.A.E. No. 205	-	1	-	1	1
8X-311	No. 10-32 x 3/8 rnd. hd. screw	-	3	-	3	3
X-489	1/4 oiler—press in type	-	1	-	1	1
Miscellaneous Parts						
GCE-24A	Head band	-	1	-	1	1
2X-715	No. 10-32 x 1-1/4 rnd. hd. screw	-	1	-	1	1
2X-794	No. 10-32 square nut	-	1	-	1	1

SERVICE PARTS LIST—PACKARD SUPER-EIGHT AND TWELVE

Motor Generator Regulator 131

Piece No.	Name	1500	1506	1603	1607	1707
		1501	1507	1604	1608	1708
		1502	1508	1605	No. Required	

MOTOR GENERATOR REGULATOR
(Delco Type No. 5813)

Delco
111887

The following parts are listed with the manufacturers' piece numbers and are to be ordered by these numbers. Dealers should order these parts through their distributor.

D-1867004	Cover	X	-	-	-	-
D-1858019	Cover stud	X	-	-	-	-
D-1858020	Cover stud nut	X	-	-	-	-
D-121841	Cover stud nut lockwasher	X	-	-	-	-
D-138593	Cover stud nut lockwasher (countersunk)	X	-	-	-	-
D-1860442	Current regulator assembly	X	-	-	-	-
D-1858700	Current regulator armature	X	-	-	-	-
D-1853901	Current regulator armature attach. screw	X	-	-	-	-
D-20793	Current regulator armature attach. screw L.W.	X	-	-	-	-
D-814627	Current regulator armature attach. screw plain washer	X	-	-	-	-
D-140630	Current regulator armature attach. screw nut (when necessary)	X	-	-	-	-
D-1858003	Current regulator armature spring	X	-	-	-	-
D-1858000	Current regulator insulator (on base) .	X	-	-	-	-
D-1858001	Current regulator post ins. bushing ...	X	-	-	-	-
D-1858002	Current regulator post insulator (under base)	X	-	-	-	-
D-1843521	Current regulator attaching nut	X	-	-	-	-
D-118874	Current regulator attaching nut lockwasher	X	-	-	-	-
D-823893	Current regulator attaching nut plain washer	X	-	-	-	-
D-1860443	Voltage regulator assembly	X	-	-	-	-
D-1858699	Voltage regulator armature	X	-	-	-	-
D-1853901	Voltage regulator armature attach. screw	X	-	-	-	-
D-20793	Voltage regulator armature attach. screw L.W.	X	-	-	-	-
D-814627	Voltage regulator armature attach. screw plain washer	X	-	-	-	-
D-140630	Voltage regulator armature attach. screw nut (when necessary)	X	-	-	-	-
D-1858003	Voltage regulator armature spring	X	-	-	-	-
D-1843521	Voltage regulator attaching nut	X	-	-	-	-
D-118874	Voltage regulator attaching nut lockwasher	X	-	-	-	-
D-1866143	Connector lead (Resistance to current and voltage regulator)	X	-	-	-	-
D-1858012	Connector lead sleeve	X	-	-	-	-
D-1866060	Relay assembly	X	-	-	-	-
D-1859761	Relay armature	X	-	-	-	-
D-141542	Relay armature attaching screw	X	-	-	-	-
D-141550	Relay armature attaching screw L.W. ...	X	-	-	-	-

Piece No.	Name	1500	1506	1603	1607	1707	
		1501	1507	1604	1608	1708	
		1502	1508	1605	No. Required		
D-813157	Relay armature attaching screw washer (2 hole--inner)	x	-	-	-	-	
D-1856614	Relay armature attaching screw washer (2 hole--outer)	x	-	-	-	-	
D-1866110	Relay contact (lower)	x	-	-	-	-	
D-1858613	Relay contact insulator (lower--under relay)	x	-	-	-	-	
D-132699	Relay contact attaching screw	x	-	-	-	-	
D-131044	Relay contact attaching screw lockwasher	x	-	-	-	-	
D-808335	Relay contact attaching screw insulator bushing	x	-	-	-	-	
D-1861255	Relay contact attaching screw insulator (under base)	x	-	-	-	-	
D-1858617	Relay contact attaching screw washer (2 hole under base)	x	-	-	-	-	
D-1860719	Relay post insulator bushing	x	-	-	-	-	

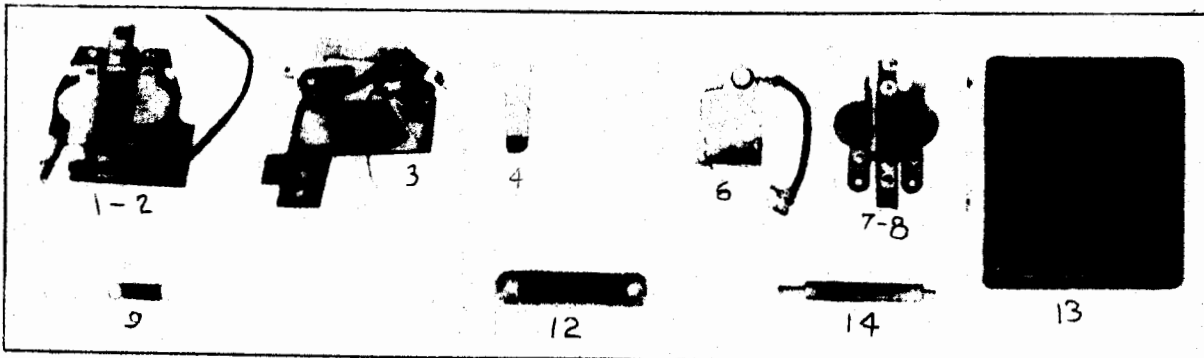

Model	No. 1 Current Regulator	No. 2 Voltage Regulator	No. 3 Relay Assembly	No. 4 Contact Lower	No. 6 Relay Armature	No. 7 Current Regulator Armature
1500-1-2	1860442	1860443	1866063	1866110	1859761	1858700
1506-7-8	1860442	1860443	1861263	1861253	1861259	1858700

Model	No. 8 Voltage Regulator Armature	No. 9 Armature Spring	No. 12 Resistance	No. 13 Cover	No. 14 Cover Stud
1500-1-2	1858699	1858003	1858018	1867004	1858019
1506-7-8	1858699	1858003	1858018	1867004	1858019

SERVICE PARTS LIST--PACKARD SUPER-EIGHT AND TWELVE

Motor Generator Regulator 133

Piece No.	Name	1500	1506	1603	1607	1707	
		1501	1507	1604	1608	1708	
		1502	1508	1605	No. Required		
D-115295	Relay attaching nut	x	-	-	-	-	
D-802731	Relay attaching nut lockwasher	x	-	-	-	-	
D-834231	Relay attaching nut plain washer	x	-	-	-	-	
D-1859195	Relay attaching nut insulator	x	-	-	-	-	
D-1865615	Resistance (inner)	x	-	-	-	-	
D-1858018	Resistance (outer)	x	-	-	-	-	
D-113901	Resistance attaching screw (6-32 x 7/16) ...	x	-	-	-	-	
D-132699	Resistance attaching screw (6-32 x 3/8)	x	-	-	-	-	
D-141550	Resistance attaching screw lockwasher	x	-	-	-	-	
D-833960	Resistance attaching screw plain washer	x	-	-	-	-	
D-1866112	Resistance attaching screw ins. bushing	x	-	-	-	-	
D-1866113	Resistance attaching screw ins. washer	x	-	-	-	-	
D-117957	Rubber grommet (in base)	x	-	-	-	-	
D-1866478	Rubber grommet sleeve (brass)	x	-	-	-	-	
D-1866165	Terminal screw	x	-	-	-	-	
D-802729	Terminal screw lockwasher	x	-	-	-	-	
D-1863593	Ground strap	x	-	-	-	-	
D-1864130	Armature bumper	x	-	-	-	-	

MOTOR GENERATOR REGULATOR
(Delco Type No. 5811)

The following parts are listed with the manufacturers' piece numbers and are to be ordered by these numbers. Dealers should order these parts through their distributor.

D-1867004	Cover	-	x	-	-	-
D-1858019	Cover stud	-	x	-	-	-
D-1858020	Cover stud nut	-	x	-	-	-
D-121841	Cover stud nut lockwasher	-	x	-	-	-
D-138593	Cover stud nut lockwasher (countersunk)	-	x	-	-	-
D-1860442	Current regulator assembly	-	x	-	-	-
D-1858700	Current regulator armature	-	x	-	-	-
D-1853901	Current regulator armature attaching screw .	-	x	-	-	-
D-20793	Current regulator armature attaching screw L.W.	-	x	-	-	-
D-814627	Current regulator armature attaching screw plain washer	-	x	-	-	-
D-140630	Current regulator armature attaching screw nut (when necessary)	-	x	-	-	-
D-1858003	Current regulator armature spring	-	x	-	-	-
D-1858000	Current regulator insulator (on base)	-	x	-	-	-
D-1858001	Current regulator post-ins. bushing	-	x	-	-	-
D-1858002	Current regulator post insulator (under base)	-	x	-	-	-
D-1843521	Current regulator attaching nut	-	x	-	-	-
D-118874	Current regulator attaching nut lockwasher .	-	x	-	-	-
D-823893	Current regulator attaching nut plain washer	-	x	-	-	-
D-1860443	Voltage regulator assembly	-	x	-	-	-
D-1858699	Voltage regulator armature	-	x	-	-	-
D-1853901	Voltage regulator armature attaching screw .	-	x	-	-	-

Piece No.	Name	1500	1506	1603	1607	1707	
		1501	1507	1604	1608	1708	
		1502	1508	1605	No. Required		
D-20793	Voltage regulator armature attaching screw L.W.	-	x	-	-	-	
D-814627	Voltage regulator armature attaching screw plain washer	-	x	-	-	-	
D-140630	Voltage regulator armature attaching screw nut (when necessary)	-	x	-	-	-	
D-1858003	Voltage regulator armature spring	-	x	-	-	-	
D-1843521	Voltage regulator attaching nut	-	x	-	-	-	
D-118874	Voltage regulator attaching nut lockwasher .	-	x	-	-	-	
D-1866143	Connector lead (resistance to current and voltage regulator)	-	x	-	-	-	
D-1858012	Connector lead sleeve	-	x	-	-	-	
D-1861263	Relay assembly	-	x	-	-	-	
D-1861259	Relay armature	-	x	-	-	-	
D-141542	Relay armature attaching screw	-	x	-	-	-	
D-141550	Relay armature attaching screw L.W.	-	x	-	-	-	
D-813157	Relay armature attaching screw washer (2 hole--inner)	-	x	-	-	-	
D-813170	Relay armature attaching screw washer (2 hole--outer)	-	x	-	-	-	
D-1861253	Relay contact (lower)	-	x	-	-	-	
D-1858613	Relay contact insulator (lower--under relay)	-	x	-	-	-	
D-132699	Relay contact attaching screw	-	x	-	-	-	
D-131044	Relay contact attaching screw lockwasher ...	-	x	-	-	-	
D-808335	Relay contact attaching screw ins. bushing .	-	x	-	-	-	
D-1861255	Relay contact attaching screw insulator (under base)	-	x	-	-	-	
D-1858617	Relay contact attaching screw washer (2 hole under base)	-	x	-	-	-	
D-1860719	Relay post insulator bushing	-	x	-	-	-	
D-115295	Relay attaching nut	-	x	-	-	-	
D-802731	Relay attaching nut lockwasher	-	x	-	-	-	
D-834231	Relay attaching nut plain washer	-	x	-	-	-	
D-1859195	Relay attaching nut insulator	-	x	-	-	-	
D-1865615	Resistance (inner)	-	x	-	-	-	
D-1858018	Resistance (outer)	-	x	-	-	-	
D-113901	Resistance attaching screw (6-32 x 7/16) ...	-	x	-	-	-	
D-132699	Resistance attaching screw (6-32 x 3/8)	-	x	-	-	-	
D-141550	Resistance attaching screw lockwasher	-	x	-	-	-	
D-833960	Resistance attaching screw plain washer	-	x	-	-	-	
D-1866112	Resistance attaching screw ins. bushing	-	x	-	-	-	
D-1866113	Resistance attaching screw ins. washer	-	x	-	-	-	
D-117957	Rubber grommet (in base)	-	x	-	-	-	
D-1866478	Rubber grommet sleeve (brass)	-	x	-	-	-	
D-1866165	Terminal screw	-	x	-	-	-	
D-802795	Terminal screw lockwasher	-	x	-	-	-	
D-1863593	Ground strap	-	x	-	-	-	
D-1864130	Armature bumper	-	x	-	-	-	

Piece No.	Name	1500	1506	1603	1607	1707
		1501	1507	1604	1608	1708
		1502	1508	1605	No. Required	

MOTOR GENERATOR REGULATOR (12 Volts)
(Electric Auto-Lite No. VRE-4002A)

The following parts are listed with the manufacturers' piece numbers and are to be ordered by these numbers. Dealers should order these parts through their distributor.

VRE-1002A	Cover	-	-	1	-	-
TC-51M	Carbon resistance (Marked 60)	-	-	1	-	-
8X-55	Screw No. 8-32 x 3/8 rnd. hd.	-	-	2	-	-
X-196	Lockwasher No. 10	-	-	6	-	-
8X-312	Screw No. 10-32 x 1/4 rnd. hd.	-	-	6	-	-
X-1275	Washer No. 8 Shakeproof	-	-	2	-	-
8X-1503	Washer No. 8 plain	-	-	2	-	-

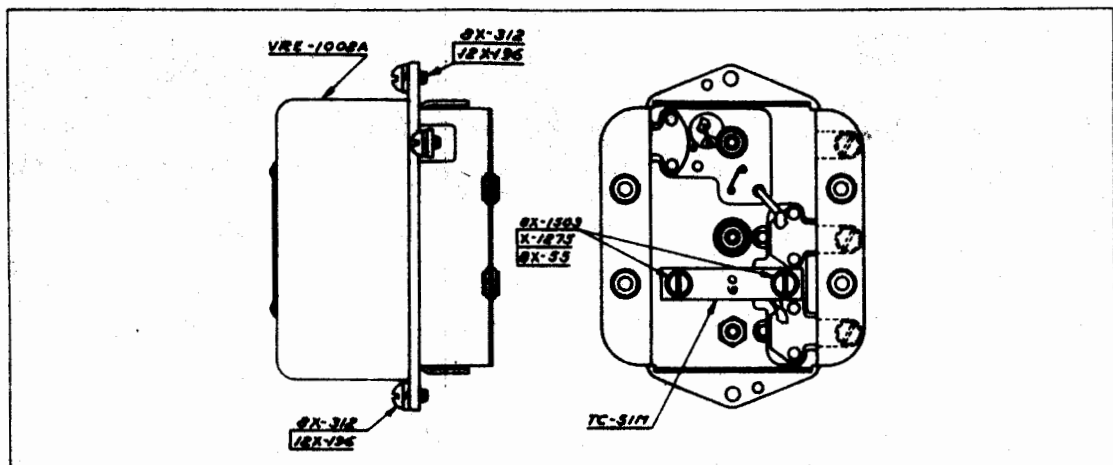

Models 1603-4-5 (12 Volt)

MOTOR GENERATOR REGULATOR (6 Volt)
(Electric Auto-Lite No. VRB-4002-D For 1500-1-2-1603-4-5) AND 1703
(Electric Auto-Lite No. VRB-4008-A For 1506-7-8-1607-8)

The following parts are listed with the manufacturers' piece numbers and are to be ordered by these numbers. Dealers should order these parts through their distributor.

TC-51-M	Carbon resistance	1	1	1	1	1
8X-1494	Screw No. 8-32 x 11/16 rnd. hd.	1	1	1	1	1
CB-123	Armature spring	3	3	3	3	3
TC-51-L	Carbon resistance	1	-	1	-	-
TC-51-R	Carbon resistance	-	1	-	1	1
VRB-1002	Cover	1	1	1	1	1

Piece No.	Name	1500	1506	1603	1607	1707	
		1501	1507	1604	1608	1708	
		1502	1508	1605	No. Required		
8X-55	Screw No. 8-32 x 3/8 rnd. hd.	2	2	2	2	2	
X-196	Lockwasher No. 10	6	6	6	6	6	
8X-312	Screw No. 10-32 x 1/4 rnd. hd.	6	6	6	6	6	
8X-350	Washer No. 8 plain	3	3	3	3	3	
X-1275	Washer No. 8 Shakeproof	3	3	3	3	3	
8X-56	Screw No. 8-32 x 7/16 rnd. hd.	2	2	2	2	2	

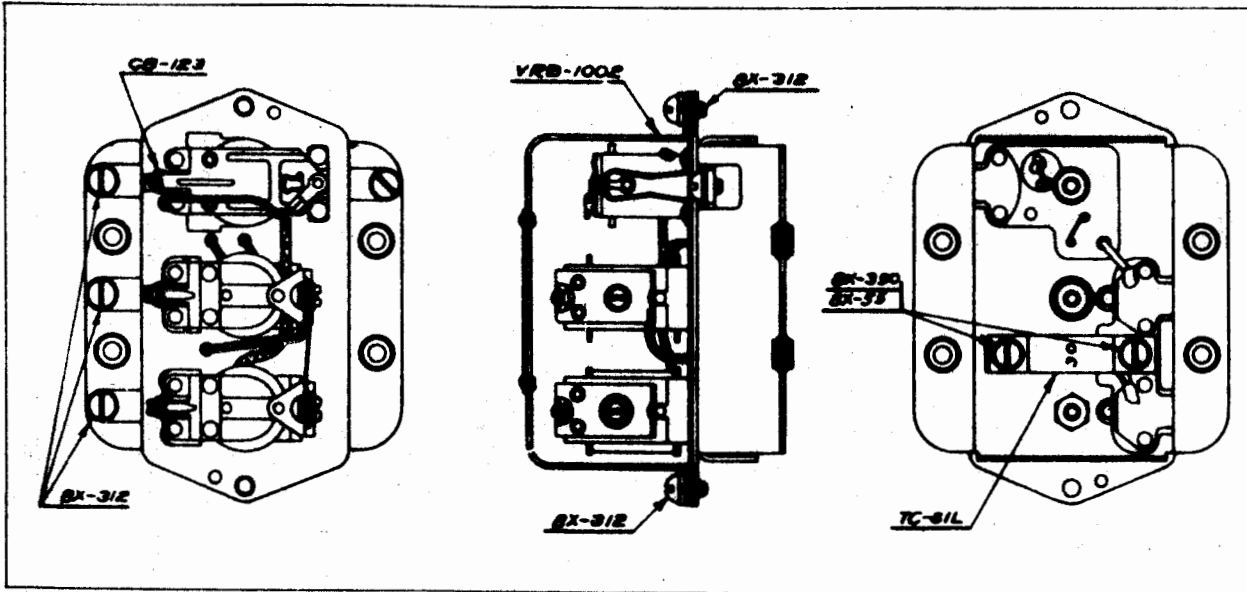

Models 1500-1-2, 1603-4-5 (6 Volt)

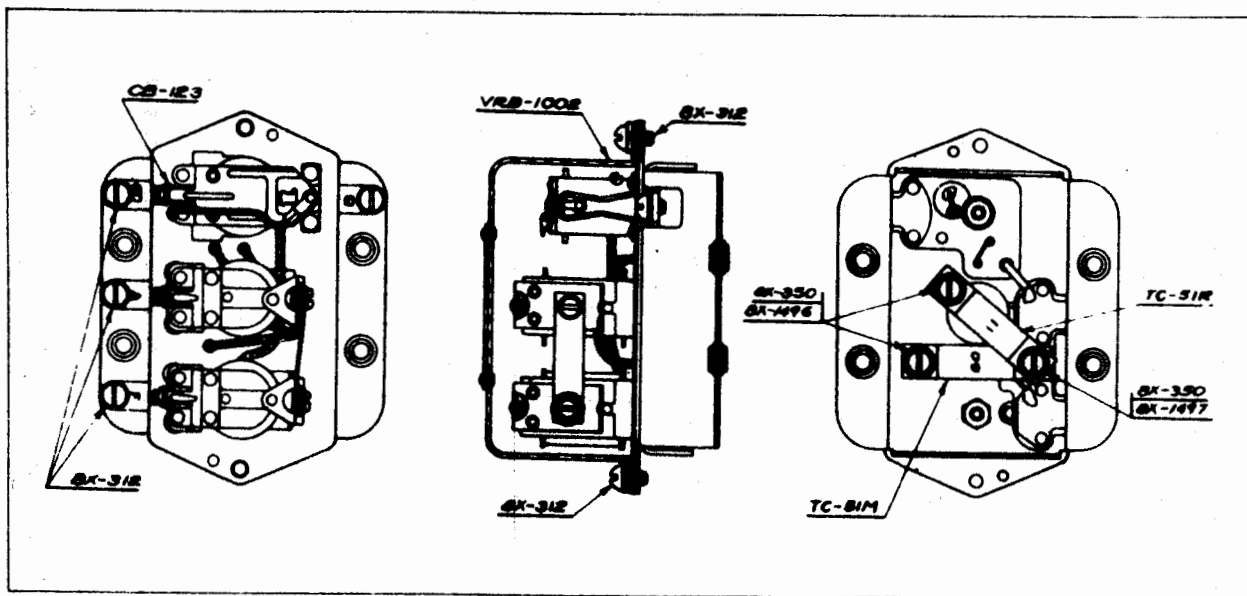

Models 1506-7-8, 1607-8, 1707-8 (6 Volt)

SERVICE PART LIST--PACKARD SUPER-EIGHT AND TWELVE

Motor Ignition Coil 137

Piece No.	Name	1500	1506	1603	1607	1707	
		1501	1507	1604	1608	1708	
		1502	1508	1605	No. Required		

MOTOR IGNITION COIL AND CABLES

0242226	Motor ignition cable set (high tension) (For Auto-Lite units)	1	-	-	-	-
0239076	Motor ignition cable set (high tension) (For Delco units)	1	-	-	-	-
0242227	Motor ignition cable set (high tension)	-	-	1	-	-
0237518	Motor ignition cable set (high tension)	-	1	-	1	1
223660	Motor ignition coil (Delco)	1	-	-	-	-
239531	Motor ignition coil (Auto-Lite) (6 Volt)	1	-	1	-	-
242059	Motor ignition coil (Auto-Lite) (12 Volt)	-	-	1	-	-
215384	Motor ignition coil assembly	-	1	-	1	1
221000	Motor ignition coil assembly screw 1/4-20 x 5/8 hex. hd.	-	4	-	4	4
5502	Lockwasher 1/4	-	4	-	4	4
219954	Motor ignition coil bracket	-	1	-	1	1
221002	Motor ignition coil bracket stud	-	2	-	2	2
7005	Nut 5/16-24	-	2	-	2	2
5504	Lockwasher 5/16	-	2	-	2	2
232671	Motor ignition coil to cylinder head stud nut (7/16-20 special)	-	-	2	-	-
5806	Lockwasher 7/16 Shakeproof	-	-	2	-	-
3883	Plain washer 7/16	-	-	2	-	-
239777	Motor ignition coil to distributor high tension cable assembly	-	-	1	-	-
223796	Motor ignition coil to distributor high tension cable assembly (With Delco units)	1	-	-	-	-
239548	Motor ignition coil to distributor high tension cable assembly (Auto-Lite units)	1	-	-	-	-
209858	Motor ignition coil to distributor high tension cable assembly	-	2	-	2	2
156626	Motor ignition coil to distributor high tension cable assembly terminal--male	-	4	-	4	4
223663	Motor ignition coil to distributor high tension cable assembly terminal (With Delco units) ..	2	-	-	-	-
239541	Motor ignition coil to distributor high tension cable assembly terminal (With Auto-Lite units)	2	-	-	-	-
156625	Motor ignition coil to distributor high tension cable assembly terminal--female	-	4	-	4	4
239541	Motor ignition coil to distributor high tension cable to coil terminal	-	-	1	-	-
239775	Motor ignition coil to distributor high tension cable to distributor terminal	-	-	1	-	-

Piece No.	Name	1500	1506	1603	1607	1707	
		1501	1507	1604	1608	1708	
		1502	1508	1605	No. Required		
239776	Motor ignition coil to distributor high tension cable to distributor terminal washer	-	-	1	-	-	
216927	Motor ignition coil to distributor high tension cable assembly terminal insulator	-	2	-	2	2	
209027	Motor ignition coil to distributor low tension cable assembly	-	2	-	2	2	
33287	Motor ignition coil to distributor low tension cable assembly terminal	-	4	-	4	4	
36111	Motor ignition coil to distributor low tension cable assembly terminal insulator	-	4	-	4	4	

MOTOR IGNITION COIL
(Delco)

The following parts are listed with the manufacturers' piece numbers and are to be ordered by these numbers. Dealers should order these parts through their distributor.

D-1857870	Coil assembly (less mounting bracket)	1	-	-	-	-
D-115295	Terminal nut	1	-	-	-	-
D-141552	Terminal nut lockwasher	1	-	-	-	-
D-826213	Terminal nut plain washer	1	-	-	-	-
D-824665	Terminal clamp	1	-	-	-	-
D-1857871	Mounting bracket	1	-	-	-	-
D-132753	Mounting bracket attaching screw	3	-	-	-	-
D-141551	Mounting bracket attaching screw lockwasher .	3	-	-	-	-
D-115295	Switch lead attaching nut	1	-	-	-	-
D-141552	Switch lead attaching nut lockwasher	1	-	-	-	-
D-1839164	High tension terminal (screw type)	1	-	-	-	-

MOTOR IGNITION COIL - (6 Volt)
(Electric Auto-Lite No. CE-4026)

The following parts are listed with the manufacturers' piece numbers and are to be ordered by these numbers. Dealers should order these parts through their distributor.

CE-256S	Coil bracket	1	-	1	-	-
CE-3186KS	Coil and case assembly	1	-	1	-	-
CE-87	Secondary screw terminal	1	-	1	-	-
CE-214	Secondary terminal rubber cap	1	-	1	-	-
12X-196	No. 10 lockwasher	2	-	2	-	-
8X-870	No. 10-32 x 5/16 fill. hd. screw	1	-	1	-	-
8X-1372	No. 10-32 hex. nut	1	-	1	-	-
X-196	No. 10 lockwasher	3	-	3	-	-
8X-709	No. 10-32 x 7/16 fill. hd. screw	3	-	3	-	-
CE-207B	Lock cable assembly--comp.	1	-	-	-	-
CE-258A	Lock cable assembly--comp.	-	-	1	-	-

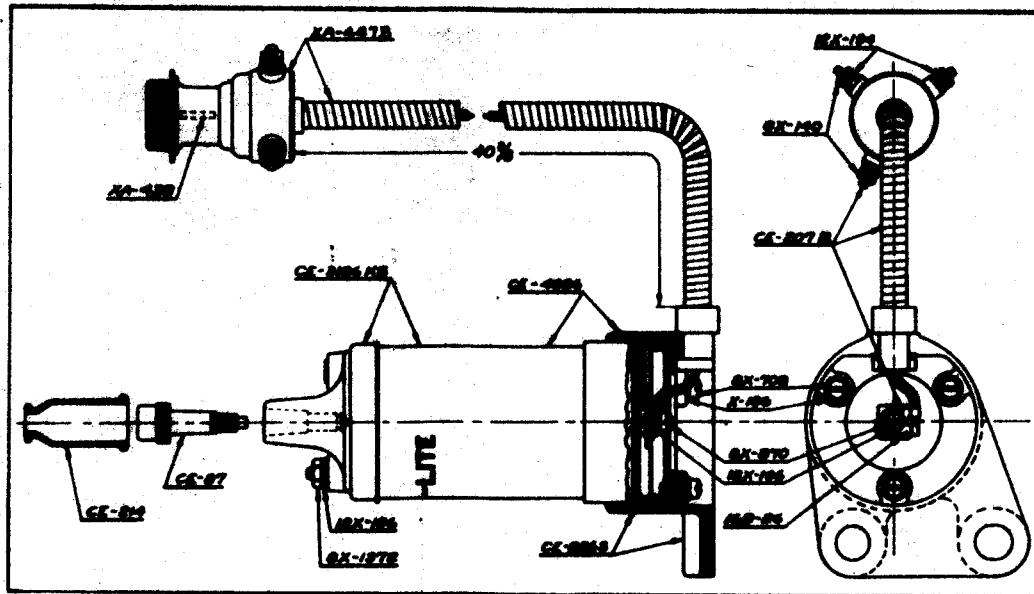

Models 1500-1-2 (6 Volt)

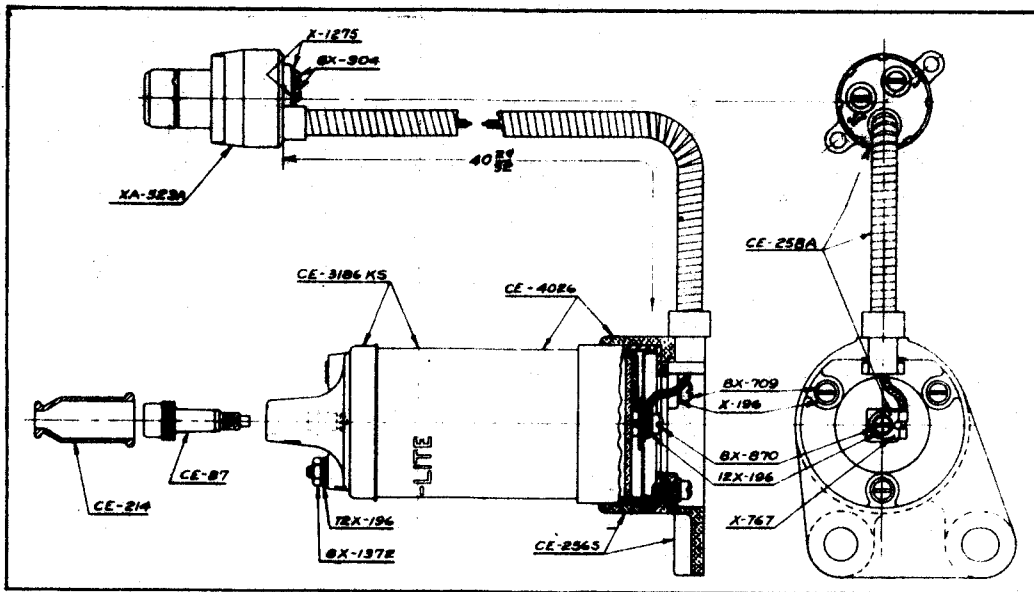

Models 1603-4-5 (6 Volt)

Piece No.	Name	1500	1506	1603	1607	1707
		1501	1507	1604	1608	1708
		1502	1508	1605		
					No. Required	
IGB-26	Terminal	1	-	-	-	-
X-767	Terminal	-	-	1	-	-
XA-447B	Lock cable assembly	1	-	-	-	-
XA-523A	Lock cable assembly	-	-	1	-	-
XA-431	Lock mounting nut	1	-	-	-	-
XA-432	Lock mounting washer	1	-	-	-	-
XA-433	Lock cylinder adapter spring	1	-	-	-	-
BX-140	No. 6-32 hex. nut	3	-	-	-	-

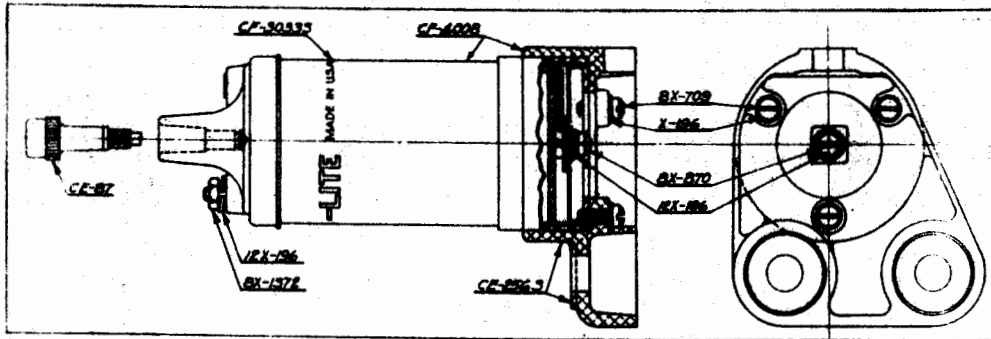

Models 1603-4-5 (12 Volt)

Piece No.	Name	1500	1506	1603	1607	1707
		1501	1507	1604	1608	1708
		1502	1508	1605	No. Required	
12X-194	No. 6 (Shakeproof) washer	3	-	-	-	-
8X-304	Screw No. 8-32 x 5/16 rnd. hd.	-	-	2	-	-
X-1275	Washer No. 8 (Shakeproof)	-	-	2	-	-

MOTOR IGNITION COIL (12 Volt)
(Electric Auto-Lite No. CF-4008)

CE-256S	Coil bracket	-	-	1	-	-
CF-3033S	Coil and case assembly	-	-	1	-	-
CE-87	Secondary screw terminal	-	-	1	-	-
12X-196	No. 10 lockwasher	-	-	2	-	-
8X-870	Screw No. 10-32 x 5/16 fill. hd.	-	-	1	-	-
8X-1372	Nut No. 10-32 hex.	-	-	1	-	-
X-196	Lockwasher No. 10	-	-	3	-	-
8X-709	Screw No. 10-32 x 7/16 fill. hd.	-	-	3	-	-

MOTOR COIL AND SWITCH
(Electric Auto-Lite No. CE-1023)

The following parts are listed with the manufacturers' piece numbers and are to be ordered by these numbers. Dealers should order these parts through their distributor.

CE-1203	Coils and bracket assembly	-	1	-	1	1
CE-203S	Coil bracket	-	1	-	1	1
CE-206	Jumper lead assembly	-	1	-	1	1
IGB-26	Terminal	-	2	-	2	2
CE-3186FS	Ignition coil part assembly	-	2	-	2	2
CE-101	Coil cover	-	1	-	1	1
CE-104	Rubber gasket	-	2	-	2	2
GK-151	Plain steel washer	-	2	-	2	2
IGL-40	No. 10-32 nut	-	1	-	1	1
X-196	No. 10 lockwasher	-	4	-	4	4
8X-1030	No. 10-32 cap nut	-	2	-	2	2
IG-511	Name plate	-	1	-	1	1
X-196	No. 10 lockwasher	-	6	-	6	6
X-453	No. 2 x 3/16 drive screw	-	2	-	2	2
8X-709	No. 10-32 x 7/16 fill. hd. screw	-	6	-	6	6
8X-870	No. 10-32 x 5/16 fill. hd. screw	-	2	-	2	2
CE-207-A	Lock cable assembly--complete	-	1	-	-	-

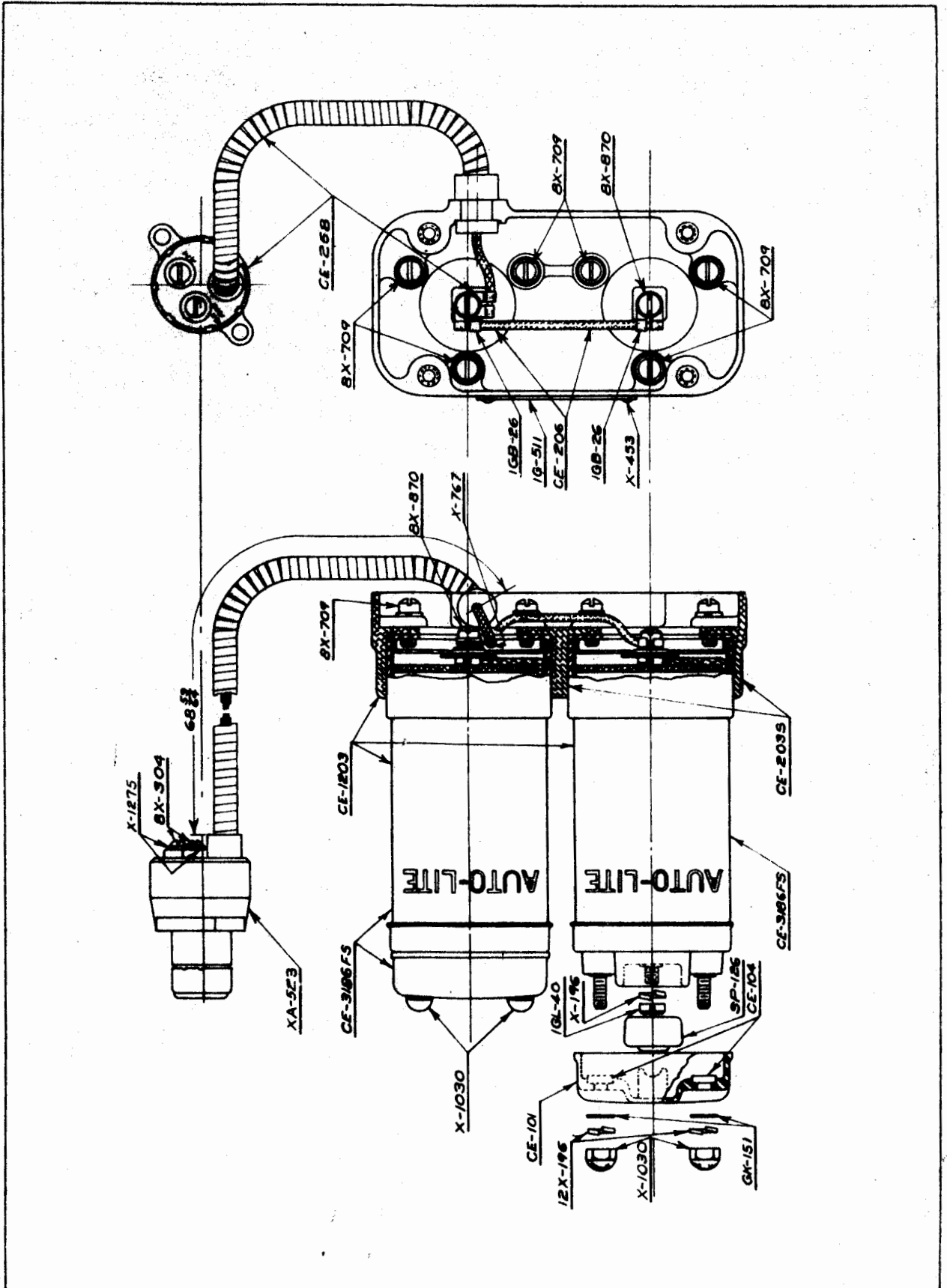

Models 1607-8, 1707-8 (6 Volt)

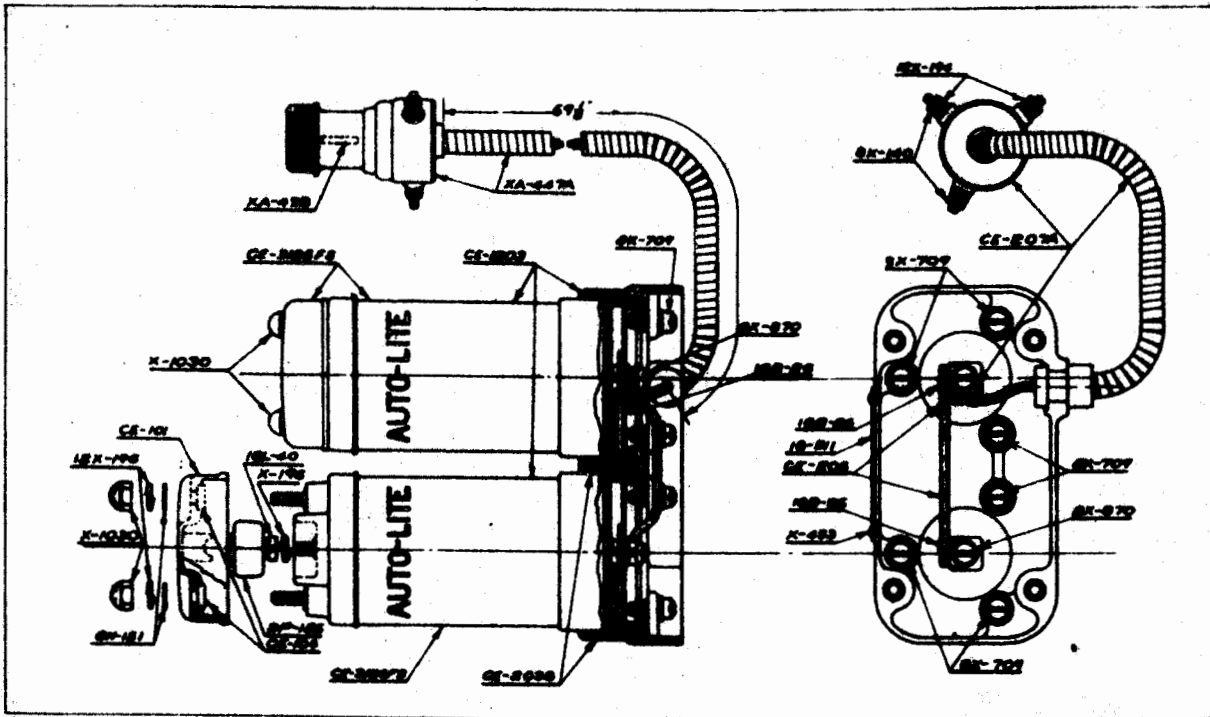

Models 1506-7-8 (6 Volt)

Piece No.	Name						
		1500	1506	1603	1607	1707	
		1501	1507	1604	1608	1708	
		1502	1508	1605			
			No. Required				
CE-258	Lock cable assembly--complete	-	-	-	1	1	
X-767	Terminal	-	-	-	1	1	
IGB-26	Terminal	-	1	-	-	-	
XA-447-A	Lock cable assembly	-	1	-	-	-	
XA-523	Lock cable assembly	-	-	-	1	1	
8X-304	Screw No. 8-32 x 5/16 rnd. hd.	-	-	-	2	2	
X-1275	Washer No. 8 Shakeproof	-	-	-	2	2	
XA-433	Lock cylinder adapter spring	-	1	-	-	-	

MOTOR IGNITION SPARK PLUG

338935	Motor ignition spark plug (Champion) (Supersedes 239400)	8	12	8	12	12
239454	Motor ignition spark plug (10 MM) (AC) (Supersedes 237672)	8	12	8	12	12
0335467	Motor ignition spark plug cover	-	-	8	12	12
239407	Motor ignition spark plug gasket	8	12	8	12	12
237673	Motor ignition spark plug gasket (Use with AC plug)	8	12	-	-	-
221499	Motor ignition spark plug nut	8	12	-	-	-
239453	Motor ignition spark plug nut	-	-	8	12	12
237630	Motor ignition spark plug cable assembly No. 1 and No. 8 (Use with Delco units for 1500-1-2)	2	-	2	-	-

SERVICE PARTS LIST--PACKARD SUPER-EIGHT AND TWELVE

Motor Ignition Spark Plug 143

Piece No.	Name	1500	1506	1603	1607	1707
		1501	1507	1604	1608	1708
		1502	1508	1605	No. Required	
237631	Motor ignition spark plug cable assembly No. 2-3-6-7 and 4 (Use with Delco units for 1500-1-2)	5	-	5	-	-
237632	Motor ignition spark plug cable assembly No. 5 (Use with Delco units for 1500-1-2)	1	-	1	-	-
239544	Motor ignition spark plug cable assembly No. 1 and 8 (With Auto-Lite units)	2	-	2	-	-
239545	Motor ignition spark plug cable assembly No. 2 and 5 (With Auto-Lite units)	2	-	-	-	-
237631	Motor ignition spark plug cable assembly No. 3 (With Auto-Lite units)	1	-	-	-	-
239546	Motor ignition spark plug cable assembly No. 4 and 7 (With Auto-Lite units)	2	-	-	-	-
239547	Motor ignition spark plug cable assembly No. 6 (With Auto-Lite units)	1	-	-	-	-
237702	Motor ignition spark plug cable assembly left No. 1 and right No. 2	-	2	-	2	2
237700	Motor ignition spark plug cable assembly left No. 2	-	1	-	1	1
237701	Motor ignition spark plug cable assembly right No. 1	-	1	-	1	1
237703	Motor ignition spark plug cable assembly left No. 3	-	1	-	1	1
237704	Motor ignition spark plug cable assembly right No. 3 and left No. 4	-	2	-	2	2
237705	Motor ignition spark plug cable assembly right No. 4	-	1	-	1	1
237706	Motor ignition spark plug cable assembly left No. 5 and right No. 5	-	2	-	2	2
237707	Motor ignition spark plug cable assembly left No. 6	-	1	-	1	1
237708	Motor ignition spark plug cable assembly right No. 6	-	1	-	1	1
205139	Motor ignition spark plug cable right No. 6 loom	-	1	-	1	1
144926	Motor ignition spark plug cable retaining ring.	2	-	2	-	-
156625	Motor ignition spark plug cable terminal--female distributor end	-	12	-	12	12
237691	Motor ignition spark plug cable terminal--spark plug end	8	12	8	12	12
156626	Motor ignition spark plug cable terminal--male distributor end	-	12	-	12	12
221016	Motor ignition spark plug cable tube assembly--left bank	-	1	-	1	1
221014	Motor ignition spark plug cable tube assembly--right bank	-	1	-	1	1
223511	Motor ignition spark plug cable tube to motor distributor cap sleeve	-	2	-	2	2

Piece No.	Name	1500	1506	1603	1607	1707
		1501	1507	1604	1608	1708
		1502	1508	1605	No. Required	

MOTOR IGNITION SWITCH

223665	Motor ignition switch and cable assembly (Delco)	1	-	-	-	-
240428	Motor ignition switch and cable assembly	-	-	1	-	-
223659	Motor ignition switch and cable assembly (Delco)	-	1	-	-	-
240429	Motor ignition switch and cable assembly	-	-	-	1	1
239542	Motor ignition switch and cable assembly (Auto-Lite)	1	-	-	-	-
239530	Motor ignition switch and cable assembly (Auto-Lite)	-	1	-	-	-
3774	Lockwasher No. 8	-	-	2	2	2
209018	Motor ignition switch cable cylinder head clip.	1	-	1	-	-
221061	Motor ignition switch cable cylinder head clip.	-	2	-	2	2
6586	Screw No. 8-32 x 1/2 rnd. hd.	-	-	2	2	2
221409	Motor ignition switch cable cylinder head water outlet flange clip	-	1	-	-	-
239455	Motor ignition switch cable cylinder head water outlet flange clip	-	-	-	1	1
213162	Motor ignition switch cable dash clip	1	1	1	1	1
167261	Motor ignition switch cable dash clip screw (No. 10 Parker Kalon)	1	1	1	1	1
219312	Motor ignition switch lock cylinder (With Delco unit)	1	1	1	1	1
210608	Motor ignition switch lock cylinder (With Auto-Lite unit)	1	1	-	-	-
228788	Motor ignition switch nut	1	1	-	-	-
228787	Motor ignition switch retainer	1	1	-	-	-

MOTOR MANIFOLD

098218	Motor manifold gasket set	-	1	-	1	1
0228769	Motor manifold gasket set	1	-	1	-	-
219826	Motor (exhaust) manifold assembly	1	-	1	-	-
219947	Motor (exhaust) manifold	-	1	-	1	1
219812	Motor (intake) manifold <i>SAME AS 1703</i>	1	-	1	-	-
197787	Motor (intake) manifold	-	1	-	1	1
197830	Motor (intake) manifold--center	-	2	-	2	2
210227	Motor (exhaust) manifold automatic choke heat plate	-	1	-	1	1
8218	Screw No. 10-32 x 1/2 flat hd. <i>1703 3/12 x 9/16</i>	-	2	-	2	2
210231	Motor (exhaust) manifold automatic choke heat plate gasket	-	1	-	-	-
239304	Motor (exhaust) manifold automatic choke heat plate spacer	-	2	-	2	2
180004	Motor (intake) manifold to cylinder gasket	4	-	4	-	-
197806	Motor (intake) manifold--center--to cylinder gasket	-	2	-	2	2
190544	Motor (exhaust) manifold to cylinder gasket--center	1	-	1	-	-
190542	Motor (exhaust) manifold to cylinder gasket--intermediate	2	-	2	-	-

1703
9.10.7
219826

SERVICE PARTS LIST--PACKARD SUPER-EIGHT AND TWELVE

Motor Manifold 145

Piece No.	Name	1500	1506	1603	1607	1707	
		1501	1507	1604	1608	1708	
		1502	1508	1605	No. Required		
180001	Motor (exhaust) manifold to cylinder gasket-- outer	2	-	2	-	-	
175911	Motor (exhaust) manifold to cylinder stud	13	-	13	-	-	
175911	Motor (intake) manifold to cylinder stud	8	-	8	-	-	
7405	Nut 5/16-24	8	-	8	-	-	
5504	Lockwasher 5/16	8	-	8	-	-	
197803	Motor (intake and exhaust) manifold to cylinder stud	-	20	-	20	20	
197777	Motor (intake and exhaust) manifold to cylinder stud cup washer	-	8	-	8	8	
205429	Motor (intake and exhaust) manifold to cylinder stud nut	-	20	-	20	20	
144514	Motor (intake and exhaust) manifold to cylinder stud washer	-	12	-	12	12	
5742	Motor (exhaust) manifold to cylinder stud washer 5/16 special	13	-	13	-	-	
7405	Nut 5/16-24	13	-	13	-	-	
232455	Motor (intake) manifold drain tube assembly ...	1	-	1	-	-	
213505	Motor (intake) manifold drain tube check valve ball	1	1	1	-	-	
213493	Motor (intake) manifold drain tube check valve ball retainer	1	1	1	1	1	
4282	Cotter pin 1/16 x 3/4	1	1	1	1	1	
213578	Motor (intake) manifold drain tube clip	1	-	1	-	-	
145255	Motor (intake) manifold drain tube clip	-	1	-	1	1	
3874	Washer 5/16	1	-	1	-	-	
6396	Motor (intake) manifold drain tube vertical-- flange stud 1/4 x 15/16	8	-	8	-	-	
5502	Lockwasher 1/4	8	-	8	-	-	
7004	Nut 1/4-28	8	-	8	-	-	
114684	Motor (intake) manifold drain tube vertical-- flange gasket	4	-	4	-	-	
210009	Motor (intake to exhaust) manifold gasket	1	-	1	-	-	
205818	Motor (exhaust) manifold gasket--center	-	4	-	4	4	
205817	Motor (exhaust) manifold gasket end	-	4	-	4	4	
205819	Motor (intake) manifold gasket--end	-	4	-	4	4	
225352	Motor (intake) manifold gasoline drain check valve body	-	2	-	2	2	
219960	Motor (intake) manifold gasoline drain check valve body gasket	-	2	-	2	2	
232924	Motor (intake) manifold gasoline drain tube lower assembly	-	1	-	1	1	
225353	Motor (intake) manifold gasoline drain tube upper assembly	-	1	-	1	1	
5867	Union nut 5/16 flared tube	-	1	-	1	1	
219952	Motor (intake) manifold gasoline drain tube upper tee	-	1	-	1	1	
219961	Motor (intake) manifold gasoline drain tube upper tee gasket	-	2	-	2	2	
219970	Motor (intake) manifold gasoline drain tube connector	-	1	-	1	1	
210208	Motor (exhaust) manifold heat control thermostat	1	-	1	-	-	

Piece No.	Name	1500	1506	1603	1607	1707	
		1501	1507	1604	1608	1708	
		1502	1508	1605	No. Required		
210016	Motor (exhaust) manifold heat control thermostat cover	1	-	1	-	-	
6326	Stud 1/4 special	2	-	2	-	-	
3868	Washer 1/4	2	-	2	-	-	
7404	Nut 1/4-28 special	2	-	2	-	-	
213472	Motor (exhaust) manifold heat control valve ...	1	-	1	-	-	
213484	Motor (exhaust) manifold heat control valve shaft	1	-	1	-	-	
3874	Washer 5/16	1	-	1	-	-	
4280	Cotter pin 1/16 x 1/2	1	-	1	-	-	
213480	Motor (exhaust) manifold heat control valve shaft bushing	2	-	2	-	-	
213518	Motor (exhaust) manifold heat control valve shaft spacer--long	1	-	1	-	-	
213481	Motor (exhaust) manifold heat control valve shaft spacer--short	1	-	1	-	-	
213747	Motor (exhaust) manifold heat control valve shaft weight	1	-	1	-	-	
5815	Motor (exhaust) manifold heat control valve shaft weight control clamp screw No. 10-32 x 7/8 fill. hd.	1	-	1	-	-	
5500	Lockwasher No. 10	1	-	1	-	-	
7003	Nut No. 10-32	1	-	1	-	-	
213745	Motor (exhaust) manifold heat control valve shaft weight key	1	-	1	-	-	
213746	Motor (exhaust) manifold heat control valve stop spring	1	-	1	-	-	
213744	Motor (exhaust) manifold heat control valve stop spring pin	1	-	1	-	-	
197817	Motor (intake) manifold--center to (intake) manifold gasket	-	2	-	2	2	
197804	Motor (intake) manifold--center to (intake) manifold stud	-	4	-	4	4	
7006	Nut 3/8-24	-	4	-	4	4	
5506	Lockwasher 3/8	-	4	-	4	4	
144514	Motor (intake) manifold--center to (intake) manifold washer	-	4	-	4	4	
197802	Motor (intake) manifold to (exhaust) manifold stud	-	2	-	2	2	
7006	Nut 3/8-24	-	2	-	2	2	
6166	Lockwasher 3/8 special heavy	-	2	-	2	2	
203791	Motor manifold spacer	-	2	-	2	2	
203792	Motor manifold spacer gasket	-	4	-	4	4	
210454	Motor (intake to exhaust) manifold screw	3	-	3	-	-	
5506	Lockwasher 3/8	3	-	3	-	-	
232150	Motor (intake) manifold to vacuum pump tube assembly	1	-	1	-	-	
6477	Motor (intake) manifold to vacuum pump tube elbow 5/16 flared tube inverted weatherhead .	2	-	2	-	-	
6475	Nut 5/16 flared tube inverted weatherhead.	2	-	2	-	-	
209571	Motor (intake) manifold to vacuum pump tube crankcase clip	1	-	1	-	-	
5392	Screw No. 10-32 x 1 fill. hd.	1	-	1	-	-	

SERVICE PARTS LIST--PACKARD SUPER-EIGHT AND TWELVE

Motor Oil Cooler 147

Piece No.	Name	1500	1506	1603	1607	1707	
		1501	1507	1604	1608	1708	
		1502	1508	1605	No. Required		
5935	Lockwasher No. 10	1	-	1	-	-	
7003	Nut No. 10-32 plain	1	-	1	-	-	
225506	Motor (intake) manifold to vacuum pump tube manifold clip	1	-	1	-	-	
210024	Motor (intake) manifold to vacuum pump tube flange gasket	1	-	1	-	-	
5471	Motor (intake) manifold to vacuum pump tube flange screw 1/4-28 x 3/4 hex. hd.	2	-	2	-	-	
5447	Lockwasher 1/4 (Shakeproof)	2	-	2	-	-	

MOTOR OIL COOLER

234917	Motor oil cooler	1	1	-	-	-
239468	Motor oil cooler assembly	-	-	1	1	1
7005	Nut 5/16-24	3	3	-	-	-
5385	Lockwasher 5/16 (Shakeproof)	3	3	-	-	-
5471	Motor oil cooler assembly to housing screw 1/4-28 x 3/4 hex. hd.	-	-	10	10	10
5502	Lockwasher 1/4	-	-	10	10	10
219994	Motor oil cooler assembly gasket	-	-	1	1	1
232164	Motor oil cooler and filter assembly	1	-	-	-	-
239473	Motor oil cooler flange gasket (Supersedes 237495)	2	1	-	-	-
234928	Motor oil cooler housing assembly	-	1	-	-	-
239425	Motor oil cooler housing assembly	-	-	-	1	1
232064	Motor oil cooler housing	1	-	1	-	-
6662	Screw 3/8-16 x 1-5/8 hex. hd.	3	-	3	-	-
6597	Lockwasher 3/8 (Shakeproof)	3	-	3	-	-
230237	Motor oil cooler housing stud--long 5/16 special	-	2	-	-	-
230292	Stud--short 5/16	-	5	-	-	-
7005	Nut 5/16-24	-	7	-	-	-
5504	Lockwasher 5/16	-	7	-	-	-
5483	Motor oil cooler housing to cover screw 5/16-24 x 3/4 hex. hd.	-	1	-	-	-
6020	Screw 5/16-24 x 15/16 hex. hd.	-	2	-	-	-
7005	Nut 5/16-24	-	2	-	-	-
5504	Lockwasher 5/16	-	3	-	-	-
230222	Motor oil cooler housing cover assembly	-	1	-	-	-
219988	Motor oil cooler housing cover	1	-	-	-	-
5430	Screw 1/4-28 x 1/2 hex. hd.	10	-	-	-	-
5447	Lockwasher 1/4 (Shakeproof)	10	-	-	-	-
230234	Motor oil cooler housing cover to cylinder screw 3/8-24 x 3-1/2 hex. hd.	-	1	-	-	-
6606	Screw 3/8-24 x 1-3/4 hex. hd.	-	1	-	-	-
6605	Screw 3/8-24 x 1 hex. hd.	-	1	-	-	-
221415	Washer 3/8 plain special	-	1	-	-	-
6048	Lockwasher 3/8 (Shakeproof) special	-	2	-	-	-
219994	Motor oil cooler housing cover gasket	1	-	-	-	-
230235	Motor oil cooler housing cover gasket	-	1	-	-	-
232625	Motor oil cooler housing cover to cylinder gasket	-	1	-	-	-
230241	Motor oil cooler housing cover plug	-	2	-	-	-
228827	Motor oil cooler housing drain cock	1	-	1	-	-

Piece No.	Name	1500	1506	1603	1607	1707
		1501	1507	1604	1608	1708
		1502	1508	1605	No. Required	
234966	Motor oil cooler housing drain cock tube assy. .	1	-	1	-	-
6475	Motor oil cooler housing drain cock tube nut 5/16 flared tube inverted	1	-	1	-	-
221413	Motor oil cooler housing mounting stud (3/8 special)	-	2	-	2	2
7006	Nut 3/8-24	-	2	-	2	2
3877	Washer 3/8	-	2	-	2	2
5506	Lockwasher 3/8	-	2	-	2	2
219712	Motor oil cooler housing outlet gasket	-	1	-	1	1
6646	Motor oil cooler housing plug	-	1	-	1	1
240517	Motor oil cooler outlet tube to relief valve body flange	-	-	-	1	1
6061	Screw 5/16-18 x 7/8 hex. hd.	-	-	-	2	2
6044	Lockwasher 5/16 internal (Shakeproof)	-	-	-	2	2
239579	Motor oil cooler outlet tube to relief valve body flange gasket	-	-	-	1	1

MOTOR OIL FILLER

234740	Motor oil filler assembly	1	-	1	-	-
240531	Motor oil filler assembly	-	-	-	1	1
237654	Motor oil filler assembly	-	1	-	-	-
6098	Screw 3/8-24 x 1-3/8 hex. hd.	-	2	-	2	2
5506	Lockwasher 3/8	-	2	-	2	2
3877	Washer 3/8 plain	-	2	-	2	2
6040	Motor oil filler body clamp screw 5/16-24 x 2-5/8 hex. hd.	-	-	-	1	1
3874	Washer 5/16	-	-	-	1	1
5504	Lockwasher 5/16	-	-	-	1	1
7005	Nut 5/16-24	-	-	-	1	1
240462	Motor oil filler breather tube	-	-	-	1	1
232468	Motor oil filler breather tube	-	1	-	-	-
197711	Motor oil filler breather tube lock screw	-	1	-	1	1
197761	Motor oil filler breather tube seal	-	1	-	1	1
232692	Motor oil filler cap	1	-	1	-	-
197828	Motor oil filler cap	-	1	-	-	-
240529	Motor oil filler cap	-	-	-	1	1
197763	Motor oil filler gasket	-	1	-	1	1

MOTOR OIL FILTER

223079	Motor oil filter assembly	1	1	1	1	-
338242	Motor oil filter assembly	-	-	-	-	1
230238	Motor oil filter bracket	-	2	-	2	2
232582	Motor oil filter bracket--front	1	-	1	-	-
232654	Motor oil filter bracket--rear	1	-	1	-	-
7004	Nut 1/4-28	3	-	3	-	-
5447	Lockwasher 1/4 (Shakeproof)	3	-	3	-	-
230304	Motor oil filter bracket screw 5/16 special ...	-	4	-	-	-
205981	Motor oil filter bracket screw	-	-	-	4	4

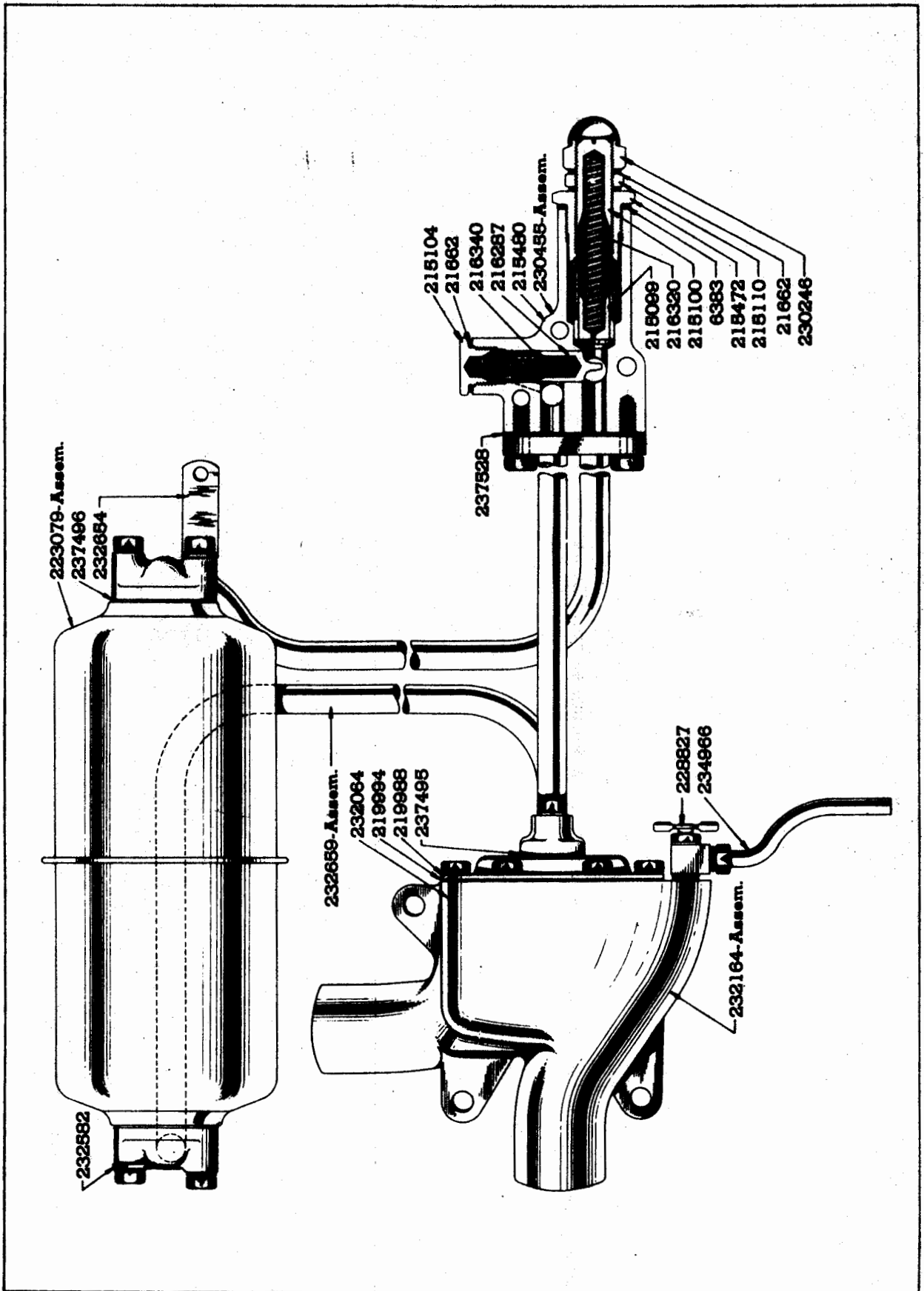

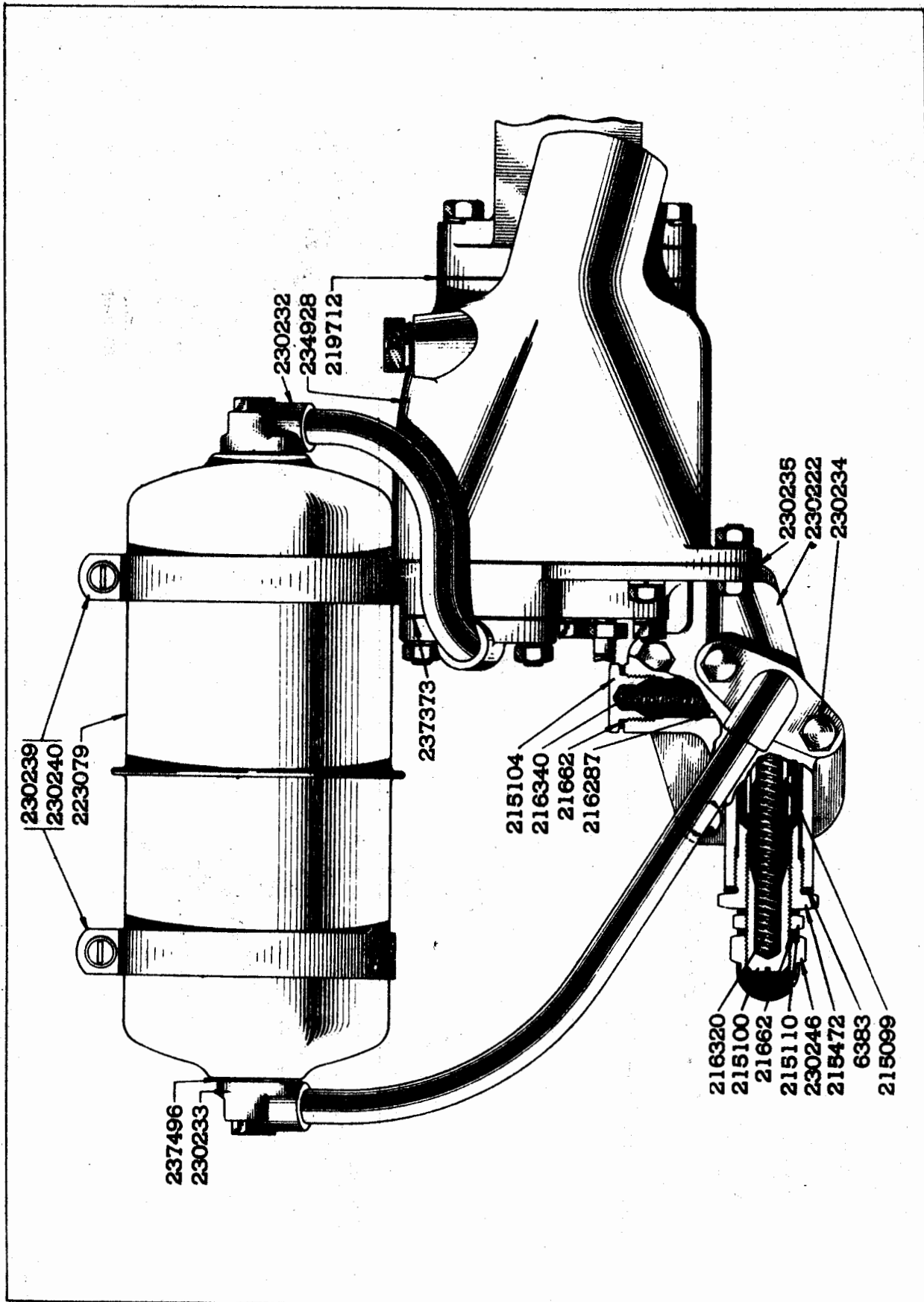

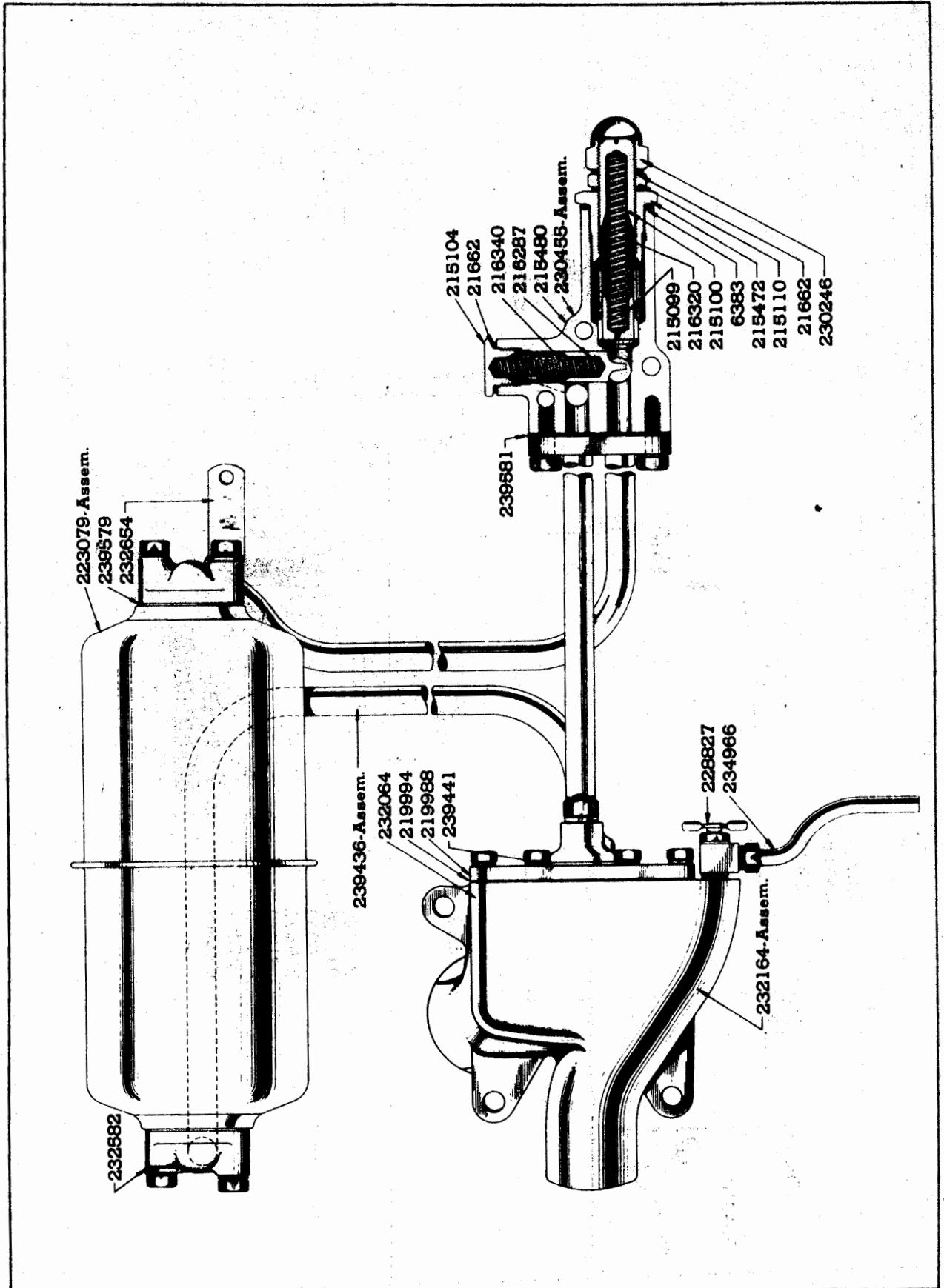

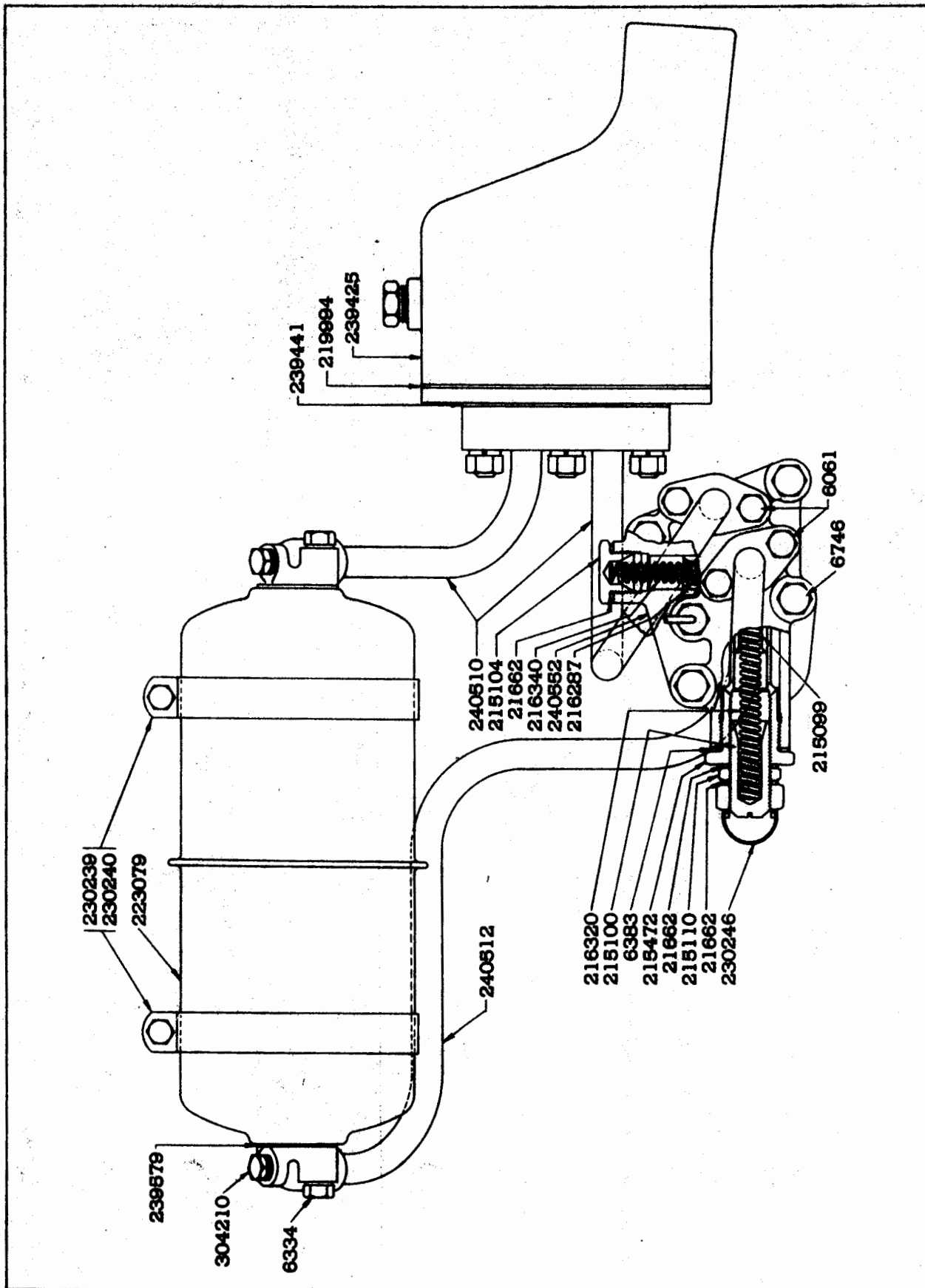

SERVICE PARTS LIST--PACKARD SUPER-EIGHT AND TWELVE

Motor Oil Filter 153

Piece No.	Name	1500	1506	1603	1607	1707	
		1501	1507	1604	1608	1708	
		1502	1508	1605	No. Required		
7005	Nut 5/16-24 plain	-	4	-	4	4	
209713	Washer	-	4	-	4	4	
5385	Lockwasher 5/16 (Shakeproof)	-	4	-	4	4	
239436	Motor oil filter and cooler tubes assembly	-	-	1	-	-	
240510	Motor oil filter and cooler tubes assembly	-	-	-	1	1	
7006	Motor oil filter and cooler tubes oil cooler flange stud nut 3/8-24	-	-	3	3	3	
5506	Lockwasher 3/8	-	-	3	3	3	
239441	Motor oil filter and cooler tubes oil cooler flange gasket	-	-	1	1	1	
239579	Motor oil filter and cooler tubes oil filter flange gasket	-	-	2	-	-	
8043	Screw 5/16-24 x 1-1/4 hex. hd.	-	-	4	-	-	
6044	Lockwasher 5/16 internal (Shakeproof)	-	-	4	-	-	
239581	Motor oil filter and cooler tubes oil relief valve flange gasket	-	-	1	-	-	
5577	Screw 5/16-24 x 7/8 hex. hd.	-	-	2	-	-	
5385	Lockwasher 5/16 (Shakeproof)	-	-	2	-	-	
239579	Motor oil filter flange gasket (Supersedes 237496)	2	2	-	-	-	
8043	Screw 5/16-24 x 1-1/4 hex. hd.	4	-	-	-	-	
6334	Screw 5/16-24 x 1 hex. hd.	-	4	-	-	-	
6044	Lockwasher 5/16 int. (Shakeproof or Everlock)	4	4	-	-	-	
232659	Motor oil filter inlet and outlet tube assembly	1	-	-	-	-	
239581	Motor oil filter inlet and outlet tube flange gasket (Supersedes 237528)	1	-	-	-	-	
5577	Screw 5/16-24 x 7/8 hex. hd.	2	-	-	-	-	
5385	Lockwasher 5/16 (Shakeproof)	2	-	-	-	-	
230233	Motor oil filter inlet tube assembly	-	1	-	-	-	
240512	Motor oil filter inlet tube assembly	-	-	-	1	1	
6334	Screw 5/16-24 x 1" hex. hd.	-	-	-	2	2	
6044	Lockwasher 5/16 internal (Shakeproof)	-	-	-	2	2	
239578	Motor oil filter inlet tube flange gasket (Supersedes 237372)	-	1	-	-	-	
239579	Motor oil filter inlet tube flange gasket	-	-	-	2	2	
6605	Screw 3/8-24 x 1 hex. hd.	-	1	-	-	-	
6048	Lockwasher 3/8 (Shakeproof)	-	1	-	-	-	
304210	Motor oil filter inlet tube flange--upper--plug	-	-	-	1	1	
6061	Screw 5/16-18 x 7/8 hex. hd.	-	-	-	2	2	
6044	Lockwasher 5/16 internal (Shakeproof)	-	-	-	2	2	
230232	Motor oil filter outlet tube assembly	-	1	-	-	-	
239580	Motor oil filter outlet tube flange gasket (Supersedes 237373)	-	1	-	-	-	
6334	Screw 5/16-24 x 1 hex. hd.	-	-	-	2	2	
6044	Lockwasher 5/16 internal (Shakeproof)	-	-	-	2	2	
304210	Motor oil filter outlet tube flange--upper--plug	-	-	-	1	1	
239579	Motor oil filter outlet tube flange--upper--gasket	-	-	-	1	1	
230239	Motor oil filter strap--long	-	2	-	2	2	
230240	Motor oil filter strap--short	-	2	-	2	2	
7858	Motor oil filter strap screw 1/4-20 x 1 fill. hd.	-	-	-	2	2	
6696	Screw 1/4-28 x 1 fill. hd.	-	2	-	-	-	
5447	Lockwasher 1/4 (Shakeproof)	-	2	-	2	2	
7004	Nut 1/4-28	-	2	-	-	-	
7304	Nut 1/4-20	-	-	-	2	2	

Piece No.	Name	1500	1506	1603	1607	1707	
		1501	1507	1604	1608	1708	
		1502	1508	1605	No. Required		

MOTOR OIL LEVEL INDICATOR

228895	Motor oil level indicator assembly	1	-	1	-	-
228896	Motor oil level indicator assembly	-	1	-	1	1
228899	Motor oil level indicator adapter	1	1	1	1	1
197762	Motor oil level indicator gland	1	1	1	1	1
197759	Motor oil level indicator gland packing	1	1	1	1	1

MOTOR OIL MANIFOLD

240034	Motor oil manifold assembly	-	-	-	1	1
221080	Motor oil manifold assembly	1	-	1	-	-
219815	Motor oil manifold assembly	-	1	-	-	-
7827	Screw 1/4-28 x 3/4 hex. hd.	18	-	18	-	-
7804	Screw 5/16-18 x 3/4 hex. hd.	-	6	-	6	6
5502	Lockwasher 1/4	18	-	18	-	-
5504	Lockwasher 5/16	-	6	-	6	6
197736	Motor oil manifold bearing flange gasket	-	3	-	3	3
114684	Motor oil manifold flange gasket (2 bolt spl.)	9	-	9	-	-
203802	Motor oil manifold to oil pump body stud	-	2	-	-	-
7809	Motor oil manifold to oil pump body screw 5/16-24 x 7/8 hex. hd.	2	-	2	-	-
6061	Motor oil manifold to oil pump body screw 5/16-18 x 7/8 hex. hd.	-	-	-	2	2
7005	Nut 5/16-24	-	2	-	-	-
5504	Lockwasher 5/16	2	2	2	2	2
6504	Motor oil manifold to oil pump crankcase flange tube flange stud 5/16-24 x 1-13/32 spl.	2	-	2	-	-
5504	Lockwasher 5/16	2	-	2	-	-
7005	Nut 5/16-24	2	-	2	-	-
215117	Motor oil manifold to oil pump crankcase flange tube flange gasket	1	-	1	-	-
197736	Motor oil manifold oil pump flange gasket	1	-	1	-	-
216448	Motor oil manifold oil pump flange gasket	-	1	-	-	-
219891	Motor oil manifold oil pump flange gasket	-	-	-	1	1
6061	Motor oil manifold oil relief flange to cylinder screw 5/16-18 x 7/8 hex. hd.	-	2	-	2	2
5504	Lockwasher 5/16	-	2	-	2	2
219891	Motor oil manifold oil relief flange gasket ...	-	1	-	1	1

MOTOR OIL PAN

240033	Motor oil pan	-	-	-	1	1
232008	Motor oil pan	1	-	1	-	-
219909	Motor oil pan	-	1	-	-	-
232011	Motor oil pan gasket	1	-	1	-	-
219920	Motor oil pan gasket	-	1	-	1	1
144930	Motor oil pan drain plug	1	1	1	1	1
20075	Motor oil pan drain plug gasket	1	1	1	1	1

SERVICE PARTS LIST--PACKARD SUPER-EIGHT AND TWELVE

Oil Pressure Relief Valve 155

Piece No.	Name	1500	1506	1603	1607	1707
		1501	1507	1604	1608	1708
		1502	1508	1605	No. Required	
6187	Motor oil pan retaining screw 5/16-18 x 1 hex. hd.	-	28	-	28	28
5504	Lockwasher 5/16	-	28	-	28	28
3874	Washer 5/16	-	28	-	28	28
MOTOR OIL PRESSURE BY-PASS VALVE PISTON						
216287	Motor oil pressure by-pass valve piston	1	1	1	1	1
216340	Motor oil pressure by-pass valve spring	1	1	1	1	1
215104	Motor oil pressure by-pass valve spring retainer	1	1	1	1	1
21662	Motor oil pressure by-pass valve spring retainer gasket 3/4 annular	1	1	1	1	1
MOTOR OIL PRESSURE RELIEF VALVE						
230455	Motor oil pressure relief and by-pass valves assembly	1	-	1	-	-
240626	Motor oil pressure relief and by-pass valves assembly	-	-	-	1	1
215100	Motor oil pressure relief valve adjusting screw	1	1	1	1	1
230246	Motor oil pressure relief valve adjusting screw cap	1	1	1	1	1
21662	Motor oil pressure relief valve adjusting screw cap gasket 3/4 annular	1	1	1	1	1
215110	Motor oil pressure relief valve adjusting screw nut	1	1	1	1	1
21662	Gasket 3/4 annular	1	1	1	1	1
215480	Motor oil pressure relief valve body	1	-	1	-	-
240552	Motor oil pressure relief valve body	-	-	-	1	1
6678	Screw 5/16-18 x 2-1/4	1	-	1	-	-
6746	Screw 3/8-24 x 2-1/16 hex. hd.	-	-	-	4	4
5506	Lockwasher 3/8	-	-	-	3	3
221415	Washer 3/8 special	-	-	-	1	1
6386	Stud--long 5/16 x 2-27/32 special	2	-	2	-	-
5385	Lockwasher 5/16 (Shakeproof)	3	-	3	-	-
7005	Nut 5/16-24	2	-	2	-	-
215119	Motor oil pressure relief valve body gasket ...	1	-	1	-	-
240556	Motor oil pressure relief valve body gasket ...	-	-	-	1	1
316226	Motor oil pressure relief valve body oil pressure gauge connection	-	-	-	1	1
304210	Motor oil pressure relief valve body oil pressure test hole plug	-	-	1	-	-
215472	Motor oil pressure relief valve body sleeve ...	1	1	1	1	1
6383	Gasket 1-1/8 annular	1	1	1	1	1
215099	Motor oil pressure relief valve piston	1	1	1	1	1
216320	Motor oil pressure relief valve spring	1	1	1	1	1

Piece No.	Name	1500	1506	1603	1607	1707	
		1501	1507	1604	1608	1708	
		1502	1508	1605	No. Required		
MOTOR OIL PUMP							
215475	Motor oil pump assembly	1	-	1	-	-	
240053	Motor oil pump assembly	-	-	-	1	1	
219907	Motor oil pump assembly	-	1	-	-	-	
197783	Motor oil pump to bearing cap stud	-	1	-	1	1	
5508	Lockwasher 7/16	-	1	-	1	1	
7007	Nut 7/16-20	-	1	-	1	1	
215474	Motor oil pump body assembly	1	-	1	-	-	
240055	Motor oil pump body assembly	-	-	-	1	1	
216464	Motor oil pump body assembly	-	1	-	-	-	
6438	Stud 5/16	2	-	2	-	-	
5504	Lockwasher 5/16	2	-	2	-	-	
7005	Nut 5/16-24	2	-	2	-	-	
216375	Motor oil pump body cover	-	1	-	-	-	
240049	Motor oil pump body cover	-	-	-	1	1	
215476	Motor oil pump cover and bushing assembly	1	-	1	-	-	
6174	Screw 1/4-28 x 7/8 fill. hd.	6	-	6	-	-	
7827	Screw 1/4-28 x 3/4 hex. hd.	-	5	-	-	-	
7824	Screw 1/4-28 x 5/8 hex. hd.	-	1	-	-	-	
8204	Screw--long 1/4-28 x 2 flat hd.	-	-	-	6	6	
5277	Screw--short 1/4-20 x 3/4 flat hd.	-	-	-	2	2	
7004	Nut 1/4-28	-	-	-	6	6	
5502	Lockwasher 1/4	6	6	6	8	8	
215454	Motor oil pump body cover casing	1	-	1	-	-	
216449	Motor oil pump body to crankshaft bearing cap gasket	-	1	-	1	1	
197681	Motor oil pump body dowel	-	1	-	1	1	
240017	Motor oil pump body dowel--large	-	-	-	1	1	
6384	Dowel 5/16 x 3/4	2	-	2	-	-	
216436	Motor oil pump body gasket	-	1	-	-	-	
240050	Motor oil pump body gasket	-	-	-	1	1	
215452	Motor oil pump body gasket	1	-	1	-	-	
162623	Motor oil pump drive shaft	1	-	1	-	-	
216406	Motor oil pump drive shaft bushing	1	-	1	-	-	
215947	Motor oil pump driven impeller and bushing assy.	1	1	1	-	-	
240015	Motor oil pump driven impeller and bushing assy.	-	-	-	1	1	
216138	Motor oil pump driven impeller shaft	-	1	-	-	-	
240016	Motor oil pump driven impeller shaft	-	-	-	1	1	
215458	Motor oil pump driven impeller shaft	1	-	1	-	-	
207622	Motor oil pump driving gear	1	-	1	-	-	
197682	Motor oil pump driving gear	-	1	-	1	1	
170082	Motor oil pump driving gear bearing	1	-	1	-	-	
197677	Motor oil pump driving gear lock ring	-	1	-	1	1	
197680	Motor oil pump driving gear thrust washer	-	1	-	1	1	
215489	Motor oil pump driving impeller	1	1	1	-	-	
240051	Motor oil pump driving impeller	-	-	-	1	1	
216140	Motor oil pump driving impeller shaft	-	1	-	-	-	
240013	Motor oil pump driving impeller shaft	-	-	-	1	1	
216164	Motor oil pump driving impeller shaft bushing	-	1	-	-	-	
240052	Motor oil pump driving impeller shaft bushing	-	-	-	1	1	

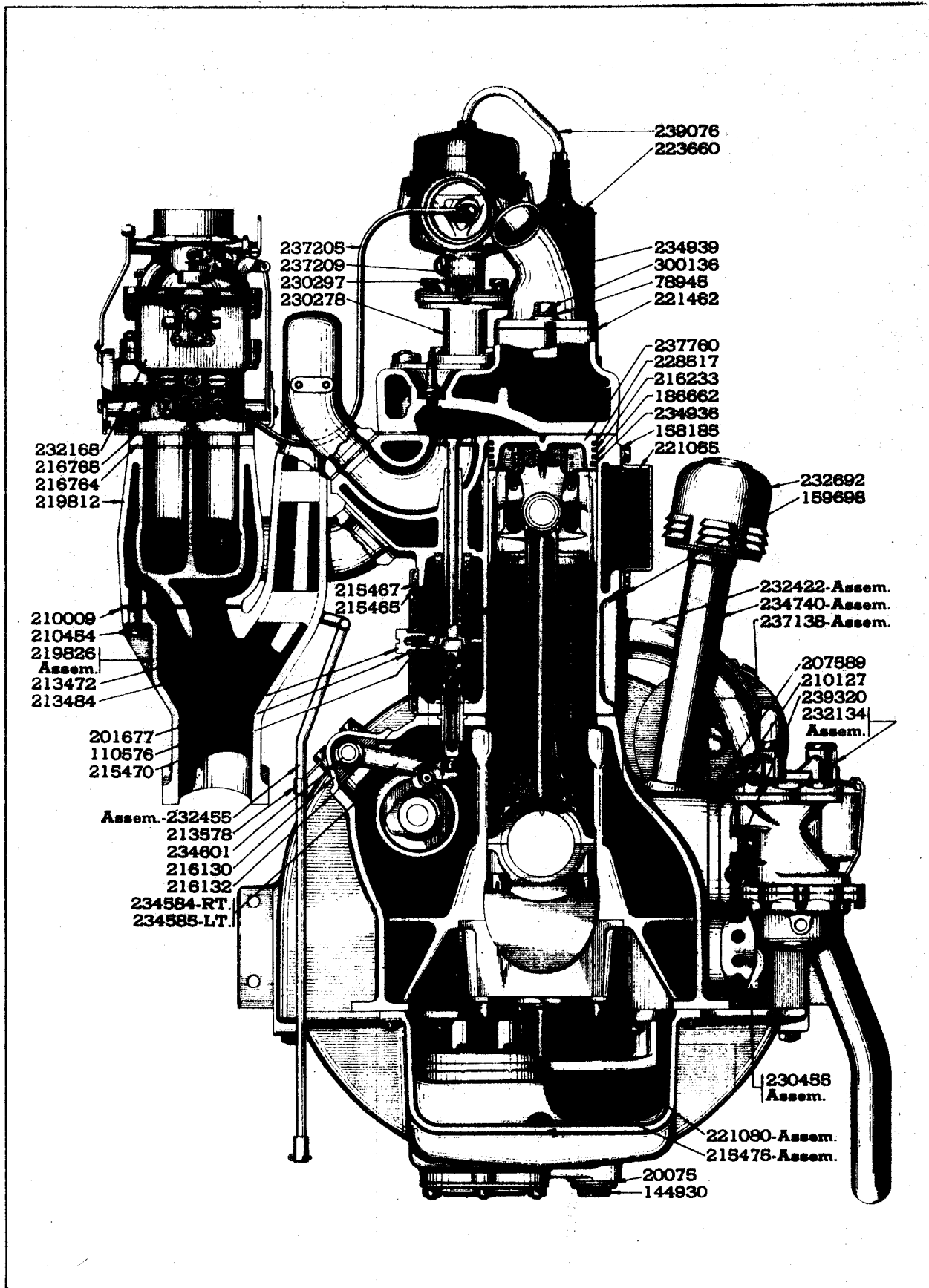

- 239076
- 223660
- 234939
- 300136
- 78948
- 221462
- 237760
- 228817
- 216233
- 186662
- 234936
- 158185
- 221065
- 232168
- 216768
- 216764
- 219812
- 210009
- 210454
- 219826
- Assem. 213472
- 213484
- 201677
- 110576
- 215470
- Assem. 232455
- 213578
- 234601
- 216130
- 216132
- 234584-RT.
- 234585-LT.
- 237205
- 237209
- 230297
- 230278
- 215487
- 215465
- 232892
- 159698
- 232422-Assem.
- 234740-Assem.
- 237138-Assem.
- 207589
- 210127
- 239320
- 232134
- Assem.
- 230455
- Assem.
- 221080-Assem.
- 215475-Assem.
- 20075
- 144930

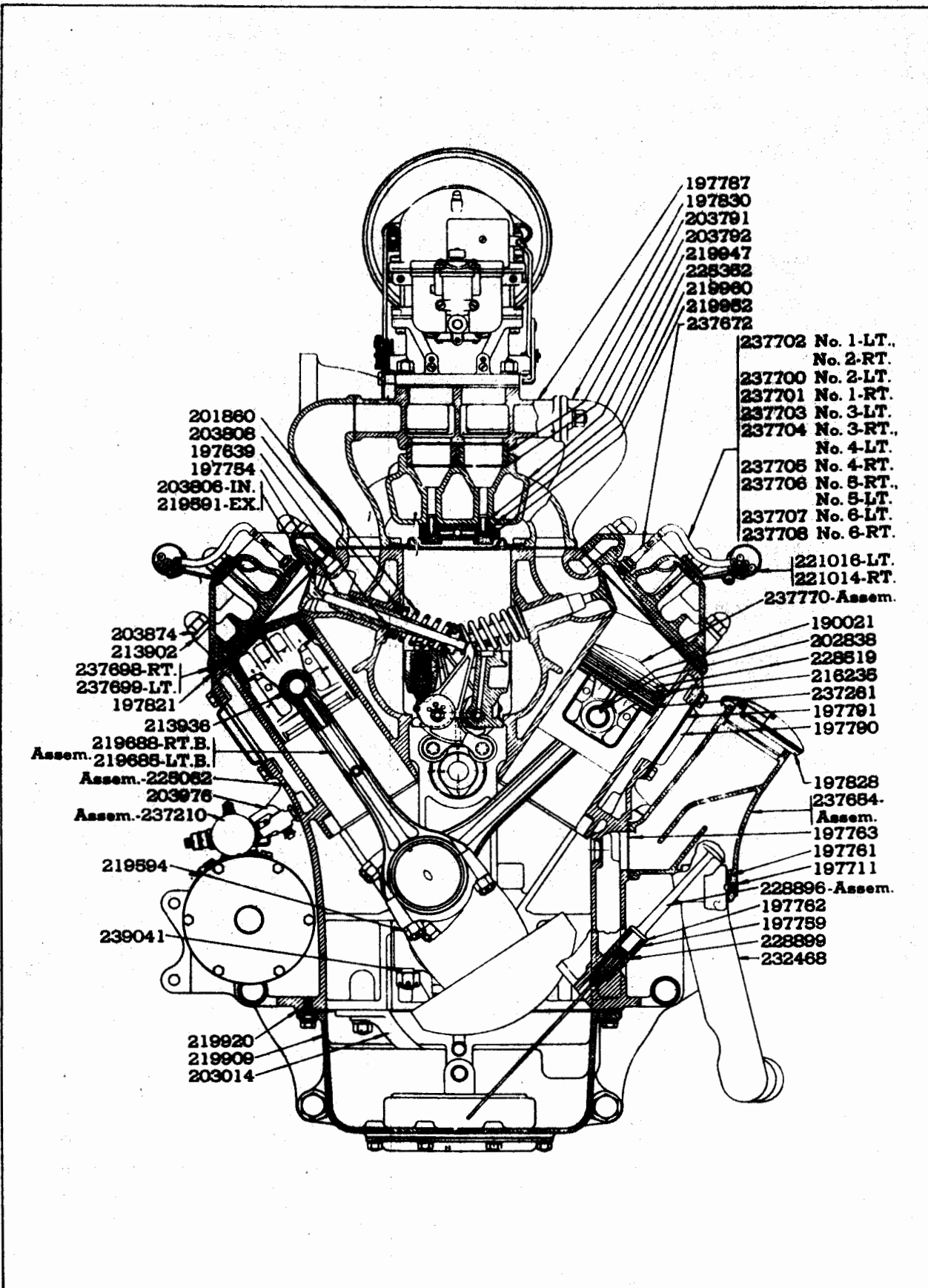

- 197787
- 197830
- 203791
- 203792
- 219947
- 228382
- 219960
- 219982
- 237672

- 237702 No. 1-LT.
- No. 2-RT.
- 237700 No. 2-LT.
- 237701 No. 1-RT.
- 237703 No. 3-LT.
- 237704 No. 3-RT.
- No. 4-LT.
- 237705 No. 4-RT.
- 237706 No. 5-RT.
- No. 5-LT.
- 237707 No. 6-LT.
- 237708 No. 6-RT.

- 201860
- 203808
- 197839
- 197784
- 203808-IN.
- 219891-EX.

- 221016-LT.
- 221014-RT.
- 237770-Assem.

- 203874
- 213902
- 237698-RT.
- 237699-LT.
- 197821
- 213936
- 219688-RT.B.
- Assem. 219688-LT.B.
- Assem. 228062
- 203978
- Assem. 237210

- 190021
- 202838
- 228619
- 216236
- 237281
- 197791
- 197790

- 219594
- 239041

- 197828
- 237684-Assem.
- 197763
- 197761
- 197711
- 228896-Assem.
- 197762
- 197759
- 228899
- 232468

- 219920
- 219909
- 203014

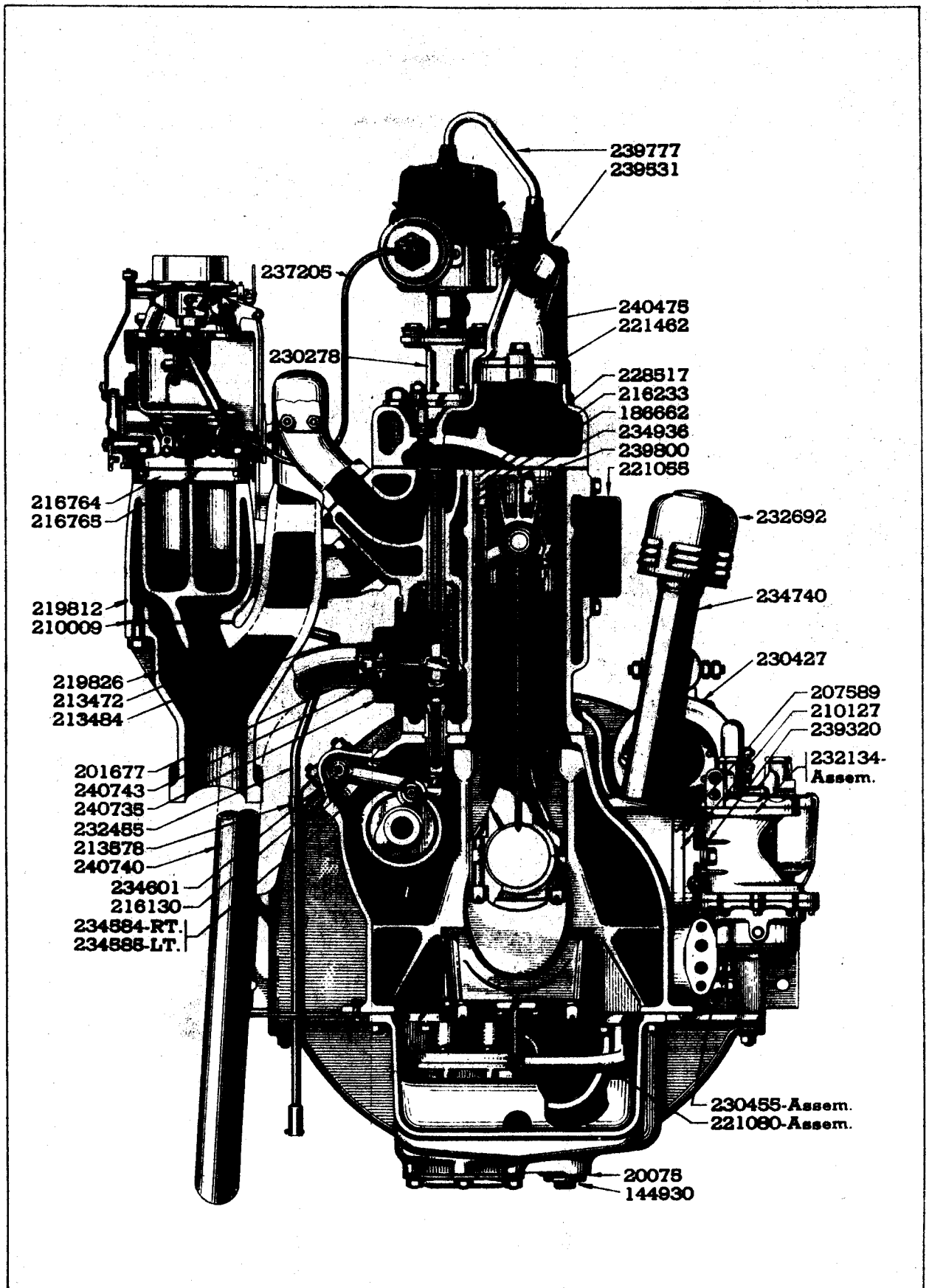

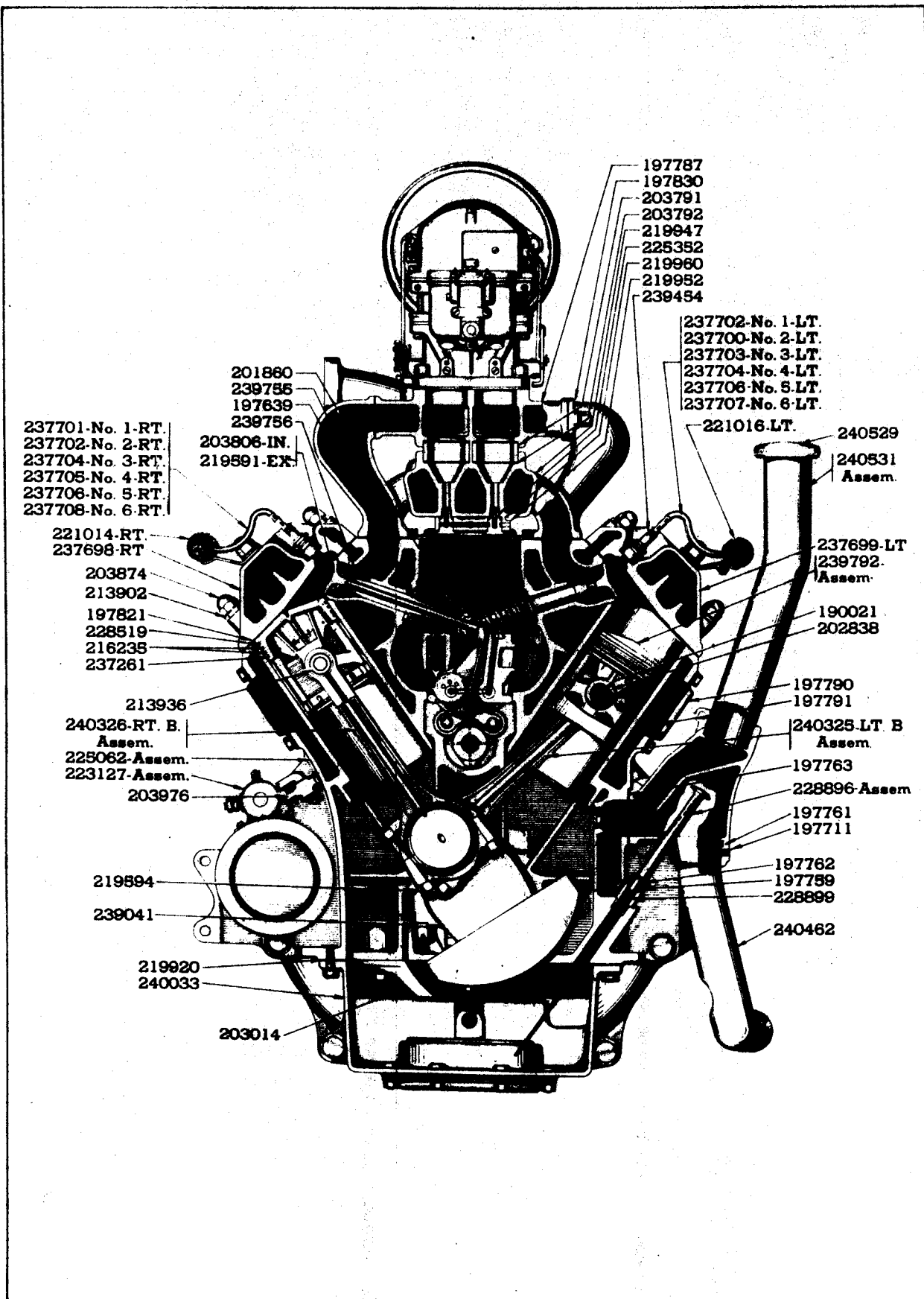

- 197787
- 197830
- 203791
- 203792
- 219947
- 225352
- 219960
- 219952
- 239454
- 237702-No. 1-LT.
- 237700-No. 2-LT.
- 237703-No. 3-LT.
- 237704-No. 4-LT.
- 237706-No. 5-LT.
- 237707-No. 6-LT.
- 221016-LT.
- 240529
- 240531 Assem.
- 237699-LT
- 239792-Assem.
- 190021
- 202838
- 197790
- 197791
- 240325-LT B Assem.
- 197763
- 228896-Assem.
- 197761
- 197711
- 197762
- 197759
- 228899
- 240462
- 201860
- 239755
- 197839
- 239756
- 203806-IN.
- 219591-EX.
- 237701-No. 1-RT.
- 237702-No. 2-RT.
- 237704-No. 3-RT.
- 237705-No. 4-RT.
- 237706-No. 5-RT.
- 237708-No. 6-RT.
- 221014-RT.
- 237698-RT.
- 203874
- 213902
- 197821
- 228519
- 216235
- 237261
- 213936
- 240326-RT. B. Assem.
- 225062-Assem.
- 223127-Assem.
- 203976
- 219594
- 239041
- 219920
- 240033
- 203014

SERVICE PARTS LIST--PACKARD SUPER-EIGHT AND TWELVE

Motor Piston 161

Piece No.	Name	1500	1506	1603	1607	1707	
		1501	1507	1604	1608	1708	
		1502	1508	1605	No. Required		

215491	Motor oil pump driving impeller shaft and collar assembly	1	-	1	-	-
4551	Motor oil pump driving impeller shaft key No. 5 Whitney	1	1	1	1	1
215488	Motor oil pump driving impeller shaft lock ring	1	1	1	1	1

MOTOR OIL STRAINER

240020	Motor oil strainer bracket cover and tube assy.	-	-	-	1	1
216378	Motor oil strainer bracket cover and tube assy.	-	1	-	-	-
197784	Motor oil strainer bracket cover and tube assembly retaining stud	-	1	-	1	1
7007	Nut 7/16-20	-	1	-	1	1
5508	Lockwasher 7/16	-	1	-	1	1
203802	Motor oil strainer bracket cover and tube assembly to motor oil pump body cover stud ..	-	2	-	-	-
7804	Screw 5/16-18 x 3/4 hex. hd.	-	-	-	2	2
7005	Nut 5/16-24	-	2	-	-	-
5504	Lockwasher 5/16	-	2	-	2	2
114542	Motor oil strainer cover plate	1	-	1	-	-
203001	Motor oil strainer cover plate	-	1	-	1	1
6015	Stud 5/16	6	8	6	8	8
5504	Lockwasher 5/16	6	8	6	8	8
7005	Nut 5/16-24	6	8	6	8	8
114886	Motor oil strainer cover plate gasket	1	-	1	-	-
203002	Motor oil strainer cover plate gasket	-	1	-	1	1
203008	Motor oil strainer frame and screen assembly ..	-	1	-	1	1
197733	Motor oil strainer lock wire	-	1	-	1	1
215455	Motor oil strainer screen assembly	1	-	1	-	-
203014	Motor oil strainer support	-	1	-	1	1
7828	Motor oil strainer support clamp bolt 5/16-24 x 1-1/8 hex. hd.	-	1	-	1	1
5504	Lockwasher 5/16	-	1	-	1	1
197736	Motor oil strainer tube flange gasket	-	1	-	1	1

MOTOR PISTON

0239800	Motor piston assembly--standard	8	-	8	-	-
0239801	Motor piston assembly---.003 oversize	8	-	8	-	-
0239802	Motor piston assembly---.005 oversize	8	-	8	-	-
0239803	Motor piston assembly---.010 oversize	8	-	8	-	-
0239804	Motor piston assembly---.015 oversize	8	-	8	-	-
0239805	Motor piston assembly---.020 oversize	8	-	8	-	-
0239806	Motor piston assembly---.025 oversize	8	-	8	-	-
0239807	Motor piston assembly---.030 oversize	8	-	8	-	-
0239808	Motor piston assembly---.035 oversize	8	-	8	-	-
0239809	Motor piston assembly---.045 oversize	8	-	8	-	-
0239792	Motor piston assembly--standard	-	12	-	12	12
0239793	Motor piston assembly---.003 oversize	-	12	-	12	12

Piece No.	Name	1500	1506	1603	1607	1707	
		1501	1507	1604	1608	1708	
		1502	1508	1605	No. Required		
0239794	Motor piston assembly--.005 oversize	-	12	-	12	12	
0239795	Motor piston assembly--.010 oversize	-	12	-	12	12	
0239796	Motor piston assembly--.015 oversize	-	12	-	12	12	
0239797	Motor piston assembly--.020 oversize	-	12	-	12	12	
0239798	Motor piston assembly--.030 oversize	-	12	-	12	12	
0239799	Motor piston assembly--.045 oversize	-	12	-	12	12	
158042	Motor piston pin	8	-	8	-	-	
202838	Motor piston pin	-	12	-	12	12	
0163879	Motor piston pin .003 oversize	8	-	8	-	-	
0163880	Motor piston pin--.006 oversize	8	-	8	-	-	
0202814	Motor piston pin--.003 oversize	-	12	-	12	12	
0202815	Motor piston pin--.006 oversize	-	12	-	12	12	
190021	Motor piston pin lock	16	24	16	24	24	
228517	Motor piston ring-plain compression--standard .	8	-	8	-	-	
0163881	Motor piston ring-plain compression--.003 oversize	8	-	8	-	-	
0163882	Motor piston ring-plain compression--.005 oversize	8	-	8	-	-	
0164630	Motor piston ring-plain compression--.010 oversize	8	-	8	-	-	
0164631	Motor piston ring-plain compression--.015 oversize	8	-	8	-	-	
0164632	Motor piston ring-plain compression--.020 oversize	8	-	8	-	-	
0213980	Motor piston ring-plain compression--.025 oversize	8	-	8	-	-	
0164633	Motor piston ring-plain compression--.030 oversize	8	-	8	-	-	
0213981	Motor piston ring-plain compression--.035 oversize	8	-	8	-	-	
0164634	Motor piston ring-plain compression--.045 oversize	8	-	8	-	-	
228519	Motor piston ring-plain compression--standard .	-	12	-	12	12	
0202800	Motor piston ring-plain compression--.003 oversize	-	12	-	12	12	
0202801	Motor piston ring-plain compression--.005 oversize	-	12	-	12	12	
0202802	Motor piston ring-plain compression--.010 oversize	-	12	-	12	12	
0202803	Motor piston ring-plain compression--.015 oversize	-	12	-	12	12	
0202804	Motor piston ring-plain compression--.020 oversize	-	12	-	12	12	
0202805	Motor piston ring-plain compression--.030 oversize	-	12	-	12	12	
0202806	Motor piston ring-plain compression--.045 oversize	-	12	-	12	12	
216233	Motor piston ring No. 70--standard	8	-	8	-	-	
0216660	Motor piston ring No. 70--.003 oversize	8	-	8	-	-	
0216661	Motor piston ring No. 70--.005 oversize	8	-	8	-	-	
0216662	Motor piston ring No. 70--.010 oversize	8	-	8	-	-	

SERVICE PARTS LIST--PACKARD SUPER-EIGHT AND TWELVE

Motor Piston 163

Piece No.	Name	1500	1506	1603	1607	1707	
		1501	1507	1604	1608	1708	
		1502	1508	1605	No. Required		
0216663	Motor piston ring No. 70--.015 oversize	8	-	8	-	-	
0216664	Motor piston ring No. 70--.020 oversize	8	-	8	-	-	
0216665	Motor piston ring No. 70--.025 oversize	8	-	8	-	-	
0216666	Motor piston ring No. 70--.030 oversize	8	-	8	-	-	
0216667	Motor piston ring No. 70--.035 oversize	8	-	8	-	-	
0216668	Motor piston ring No. 70--.045 oversize	8	-	8	-	-	
216235	Motor piston ring No. 70--standard	-	24	-	24	24	
0216678	Motor piston ring No. 70--.003 oversize	-	24	-	24	24	
0216679	Motor piston ring No. 70--.005 oversize	-	24	-	24	24	
0216680	Motor piston ring No. 70--.010 oversize	-	24	-	24	24	
0216681	Motor piston ring No. 70--.015 oversize	-	24	-	24	24	
0216682	Motor piston ring No. 70--.020 oversize	-	24	-	24	24	
0216684	Motor piston ring No. 70--.030 oversize	-	24	-	24	24	
0216686	Motor piston ring No. 70--.045 oversize	-	24	-	24	24	
186662	Motor piston ring-slotted No. 85--standard	8	-	8	-	-	
0194400	Motor piston ring-slotted No. 85--.003 oversize	8	-	8	-	-	
0194401	Motor piston ring-slotted No. 85--.005 oversize	8	-	8	-	-	
0194402	Motor piston ring-slotted No. 85--.010 oversize	8	-	8	-	-	
0194403	Motor piston ring-slotted No. 85--.015 oversize	8	-	8	-	-	
0194404	Motor piston ring-slotted No. 85--.020 oversize	8	-	8	-	-	
0213982	Motor piston ring-slotted No. 85--.025 oversize	8	-	8	-	-	
0194405	Motor piston ring-slotted No. 85--.030 oversize	8	-	8	-	-	
0213983	Motor piston ring-slotted No. 85--.035 oversize	8	-	8	-	-	
0194406	Motor piston ring-slotted No. 85--.045 oversize	8	-	8	-	-	
234936	Motor piston ring-slotted No. 90--standard	8	-	8	-	-	
234936	Motor piston ring-slotted No. 90--.003 oversize	8	-	8	-	-	
234936	Motor piston ring-slotted No. 90--.005 oversize	8	-	8	-	-	
234936	Motor piston ring-slotted No. 90--.010 oversize	8	-	8	-	-	
0311971	Motor piston ring-slotted No. 90--.015 oversize	8	-	8	-	-	
0311971	Motor piston ring-slotted No. 90--.020 oversize	8	-	8	-	-	
0311971	Motor piston ring-slotted No. 90--.025 oversize	8	-	8	-	-	
0311971	Motor piston ring-slotted No. 90--.030 oversize	8	-	8	-	-	
0311972	Motor piston ring-slotted No. 90--.035 oversize	8	-	8	-	-	
0311972	Motor piston ring-slotted No. 90--.045 oversize	8	-	8	-	-	
237261	Motor piston ring-slotted No. 90--standard	-	12	-	12	12	
237261	Motor piston ring-slotted No. 90--.003 oversize	-	12	-	12	12	
237261	Motor piston ring-slotted No. 90--.005 oversize	-	12	-	12	12	
237261	Motor piston ring-slotted No. 90--.010 oversize	-	12	-	12	12	
0311980	Motor piston ring-slotted No. 90--.015 oversize	-	12	-	12	12	
0311980	Motor piston ring-slotted No. 90--.020 oversize	-	12	-	12	12	
0311980	Motor piston ring-slotted No. 90--.030 oversize	-	12	-	12	12	
0311981	Motor piston ring-slotted No. 90--.045 oversize	-	12	-	12	12	
0242860	Motor piston ring set--standard	1	-	1	-	-	
0242861	Motor piston ring set--oversize	1	-	1	-	-	
0242892	Motor piston ring set--standard	-	1	-	1	1	
0242893	Motor piston ring set--oversize	-	1	-	1	1	
0239127	Motor piston skirt expander (3-3/16)	8	-	8	-	-	

Piece No.	Name	1500	1506	1603	1607	1707
		1501	1507	1604	1608	1708
		1502	1508	1605	No. Required	

MOTOR STABILIZER BRACKET

207815	Motor stabilizer bracket assembly	1	2	1	2	2
6039	Screw 5/16-24 x 11/16 hex. hd.	2	4	2	4	4
7005	Nut 5/16-24	2	4	2	4	4
5504	Lockwasher 5/16	2	4	2	4	4
207582	Motor stabilizer bracket bolt plate	2	3	2	3	3
7809	Screw 5/16-24 x 7/8 hex. hd.	2	4	2	4	4
7005	Nut 5/16-24	2	4	2	4	4
5504	Lockwasher 5/16	2	4	2	4	4
232645	Motor stabilizer bracket plate	1	-	1	-	-
232648	Motor stabilizer bracket plate--right	-	1	-	1	1
232645	Motor stabilizer bracket plate--left	-	1	-	1	1
7822	Motor to stabilizer bracket plate bolt 3/8-24 x 1-1/2 hex. hd.	2	4	2	4	4
5506	Lockwasher 3/8	2	2	2	2	2
7006	Nut 3/8-24	2	2	2	2	2

MOTOR STARTER MOTOR AND SWITCH

237138	Motor starter motor and switch assembly (Delco)	1	-	-	-	-
237210	Motor starter motor and switch assembly (Delco)	-	1	-	-	-
230427	Motor starter motor and switch assembly (Auto- Lite) (6 Volt)	1	-	1	-	-
223127	Motor starter motor and switch assembly (Auto-Lite)	-	1	-	1	1
242056	Motor starter motor and switch assembly (Auto- Lite) (12 Volt)	-	-	1	-	-
6516	Screw 1/4-20 x 1-1/4 hex. hd.	1	1	1	1	1
3884	Washer 1/2 plain	1	-	1	-	-
6047	Lockwasher 1/2 (Shakeproof)	1	-	1	-	-
5510	Lockwasher 1/2	-	1	-	1	1

MOTOR STARTER MOTOR AND SWITCH
(Delco Type No. 729-H)

The following parts are listed with the manufacturers' piece numbers and are to be ordered by these numbers. Dealers should order these parts through their distributor.

D-1866103	Frame and field assembly	x	-	-	-	-
D-810601	Pole shoe	x	-	-	-	-
D-828675	Pole shoe screw	x	-	-	-	-
D-826938	Terminal stud	x	-	-	-	-
D-1861076	Terminal stud ins. washer (3/4 O.D.)	x	-	-	-	-
D-809051	Terminal stud ins. washer (9/16 O.D.)	x	-	-	-	-
D-805790	Terminal stud plain washer	x	-	-	-	-
D-805258	Terminal stud nut	x	-	-	-	-

SERVICE PARTS LIST—PACKARD SUPER-EIGHT AND TWELVE

Starter Motor and Switch 165

Piece No.	Name	1500	1506	1603	1607	1707	
		1501	1507	1604	1608	1708	
		1502	1508	1605	No. Required		
D-142248	Terminal stud nut lock washer	X	-	-	-	-	
D-820153	Field coil assembly (2 coils - upper half) ..	X	-	-	-	-	
D-820154	Field coil assembly (2 coils - lower half) ..	X	-	-	-	-	
D-820171	Field coil ins. strip	X	-	-	-	-	
D-1866105	Armature	X	-	-	-	-	
D-817114	Commutator cover band	X	-	-	-	-	
D-815839	Commutator end frame and pin assembly	X	-	-	-	-	
D-817313	Brush holder hinge pin	X	-	-	-	-	
D-817314	Brush holder stop pin	X	-	-	-	-	
D-812016	Brush holder hinge pin and insulation	X	-	-	-	-	
D-812015	Brush holder stop pin and insulation	X	-	-	-	-	
D-809062	Dowel pin (C.E.)	X	-	-	-	-	
D-114998	Oiler (C.E.)	X	-	-	-	-	
D-802691	Oil wick (C.E.)	X	-	-	-	-	
D-1865182	End plug (C.E.)	X	-	-	-	-	
D-811553	Brush	X	-	-	-	-	

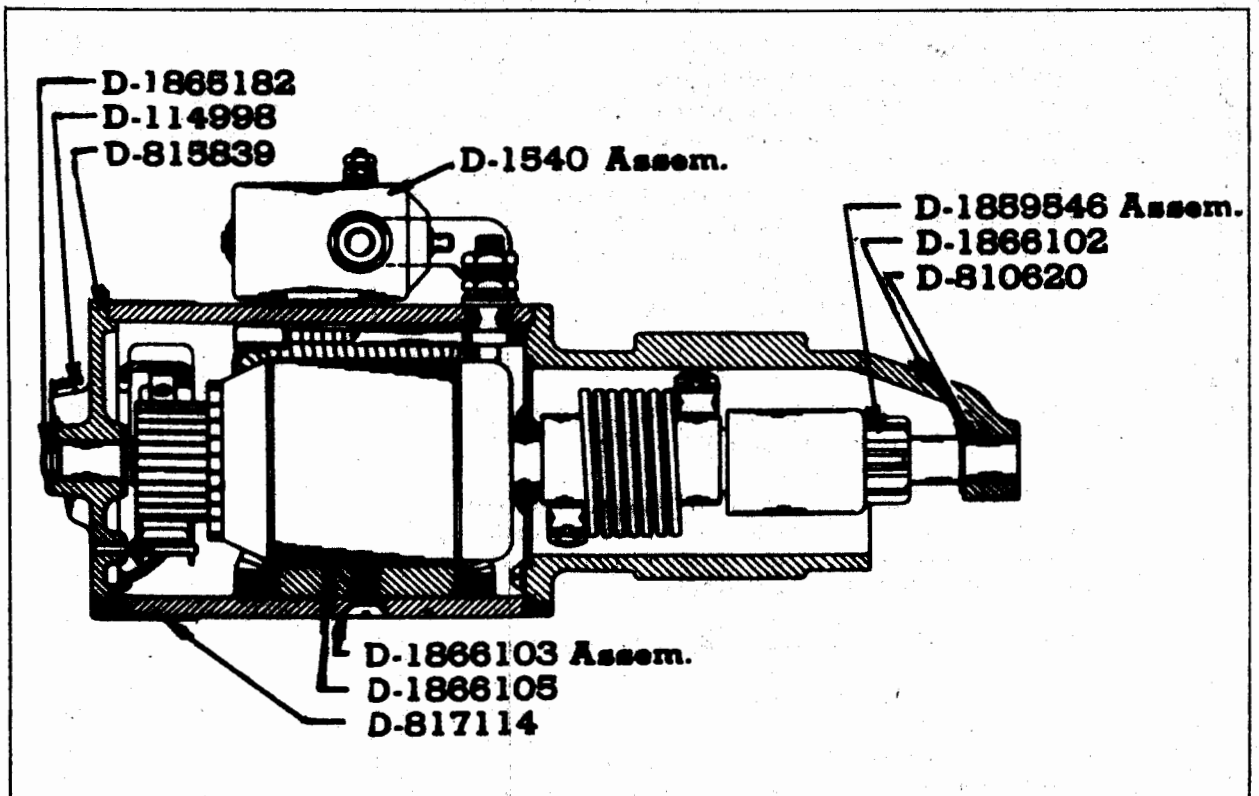

Models 1500-1-2

Piece No.	Name	1500	1506	1603	1607	1707	
		1501	1507	1604	1608	1708	
		1502	1508	1605	No. Required		
D-810226	Brush holder	x	-	-	-	-	
D-813521	Brush spring	x	-	-	-	-	
D-115903	Brush attaching screw	x	-	-	-	-	
D-141550	Brush attaching screw L.W.	x	-	-	-	-	
D-813554	Brush ground lead	x	-	-	-	-	
D-114935	Brush ground lead screw	x	-	-	-	-	
D-141551	Brush ground lead screw L.W.	x	-	-	-	-	
D-135616	Brush lead attaching screw	x	-	-	-	-	
D-141552	Brush lead attaching screw L.W.	x	-	-	-	-	
D-833602	Space washer (C.E.)	x	-	-	-	-	
D-1866102	Motor drive housing	x	-	-	-	-	
D-810620	Motor drive housing bushing	x	-	-	-	-	
D-1838667	Center bearing plate	x	-	-	-	-	
D-1838670	Center bearing bushing	x	-	-	-	-	
D-142210	Center bearing attaching screw	x	-	-	-	-	
D-802731	Center bearing attaching screw L.W.	x	-	-	-	-	
D-1853917	Space washer (D.E.)	x	-	-	-	-	
D-809593	Dowel washer (D.E.)	x	-	-	-	-	
D-124546	Woodruff key (D.E.)	x	-	-	-	-	
D-809053	Thru bolt	x	-	-	-	-	
D-141553	Thru bolt L.W.	x	-	-	-	-	
D-1540	Magnetic switch	x	-	-	-	-	
D-1860959	Magnetic switch mounting screw	x	-	-	-	-	
D-141553	Magnetic switch mounting screw L.W.	x	-	-	-	-	
D-1866107	Magnetic switch connector strap	x	-	-	-	-	
D-1859546	Motor drive assembly	x	-	-	-	-	
D-134569	Terminal stud nut (3/8-16 x 1/4 thick)	x	-	-	-	-	
D-142248	Terminal stud nut lockwasher (3/8)	x	-	-	-	-	
D-812622	Terminal stud nut plain washer (.380 I.D.) ..	x	-	-	-	-	
D-120622	Terminal stud nut (8-32)	x	-	-	-	-	
D-804485	Terminal stud nut lockwasher (No. 8)	x	-	-	-	-	

MOTOR STARTER MOTOR AND SWITCH - (6 Volt)
(Auto Lite Type MAX-4014)

The following parts are listed with the manufacturers' piece numbers and are to be ordered by these numbers. Dealers should order these parts through their distributor.

Frame and Field Assembly With Terminal Post

MAX-2123	Frame and field assembly	1	-	1	-	-
GK-38A	Pole piece screw	4	-	4	-	-
MAB-30	Field connection ins.	1	-	1	-	-
MAB-31	Insulating washer	1	-	1	-	-
MAB-85	Insulating bushing	1	-	1	-	-
MAK-80	Insulating washer	1	-	1	-	-
MAW-13	Brush assembly - grounded	2	-	2	-	-
MAW-29	Pole piece	4	-	4	-	-

SERVICE PARTS LIST—PACKARD SUPER-EIGHT AND TWELVE

Starter Motor and Switch 167

Piece No.	Name	1500	1506	1603	1607	1707	
		1501	1507	1604	1608	1708	
		1502	1508	1605	No. Required		
MAX-64	Field coil connector (Supersedes MAX-26)	2	-	2	-	-	
MAX-47	Terminal post	1	-	1	-	-	
MAX-58	Equalizer	1	-	1	-	-	
MAX-1007D	Field coil—U.L.	1	-	1	-	-	
MAX-1008S	Field coil assembly—L.R.	1	-	1	-	-	
MAW-12	Brush	1	-	1	-	-	
MAX-1009S	Field coil assembly—L.L.	1	-	1	-	-	
MAW-12	Brush	1	-	1	-	-	
MAX-1010D	Field coil—U.R.	1	-	1	-	-	
MN-21	Dowel pin	2	-	2	-	-	
MU-37	Plain washer 5/16"	1	-	1	-	-	
8X-61	Screw No. 10-32 x 7/16" flat hd.	2	-	2	-	-	
X-1014	Lockwasher 5/16"	1	-	1	-	-	
8X-1376	Nut 5/16-24 hex.	1	-	1	-	-	
MW-20B	Frame screw	2	-	2	-	-	
X-199	Lockwasher 1/4"	2	-	2	-	-	
X-1014	Lockwasher 5/16"	1	-	1	-	-	
8X-1376	Nut 5/16-24 hex.	1	-	1	-	-	

Commutator End Plate Assembly

MAX-2002B	Commutator end plate assembly	1	-	1	-	-
MAD-110	Felt pad	1	-	1	-	-
MZ-19	Brush spring	4	-	4	-	-
X-390	Oiler--1/4 hinged top	1	-	1	-	-

Armature Assembly

MAK-61	Steel washer 5/8"	1	-	1	-	-
MAW-2090	Armature assembly	1	-	1	-	-
MAB-35	Bearing thrust spacer	1	-	1	-	-
MU-54	Thrust washer	2	-	2	-	-
X-261	No. 6 Woodruff Key	1	-	1	-	-

Switch Assembly

SS-6RA	Connector	1	-	1	-	-
SS-4001	Solenoid starting switch	1	-	1	-	-
12X-196	Lockwasher No. 10	1	-	1	-	-
8X-832	Nut 5/16-24 hex.	2	-	2	-	-
12X-1014	Lockwasher 5/16"	2	-	2	-	-
8X-1372	Nut No. 10-32 hex.	1	-	1	-	-
2X-321	Screw No. 10-32 x 5/16" rnd. hd.	2	-	2	-	-
X-1270	Washer No. 10 (Shakeproof)	2	-	2	-	-

Piece No.	Name	1500	1506	1603	1607	1707
		1501	1507	1604	1608	1708
		1502	1508	1605	No. Required	

Miscellaneous Parts

EBA-12	Bendix drive assembly	1	-	1	-	-
MAB-2040	Intermediate bearing assembly	1	-	1	-	-
MG-77A	Absorbent bronze bearing	1	-	1	-	-
MAW-1024	Head band (Supersedes MAW-24A)	1	-	1	-	-
PS-1109	Pinion housing assembly	1	-	1	-	-
MAB-88	Dowel pin	1	-	1	-	-
MP-41A	Absorbent bronze bearing	1	-	1	-	-
X-489	1/4 oiler—press in type	1	-	1	-	-
2X-715	Screw No. 10-32 x 1-1/4" rnd. hd.	1	-	1	-	-
2X-794	Nut No. 10-32 square	1	-	1	-	-

MOTOR STARTER MOTOR AND SWITCH - 12 Volt
(Auto-Lite No. MAY-4017)

The following parts are listed with the manufacturers' piece numbers and are to be ordered by these numbers. Dealers should order these parts through their distributor.

Frame and Field Assembly

GK-38A	Pole piece screw	-	-	4	-	-
MAB-30	Field connection ins.	-	-	1	-	-
MAB-31	Insulating washer	-	-	1	-	-
MAB-85	Insulating bushing	-	-	1	-	-
MAK-80	Insulating washer	-	-	1	-	-
MAW-13	Brush assembly—grounded	-	-	2	-	-
MAW-29	Pole piece	-	-	4	-	-
MAX-64	Field coil connector	-	-	1	-	-
MAY-32	Field connection ins.	-	-	1	-	-
MAY-34	Terminal post	-	-	1	-	-
MAY-1007	Field coil—U.L.	-	-	1	-	-
MAY-1008	Field coil—L.R.	-	-	1	-	-
MAY-1009	Field coil—L.L.	-	-	1	-	-
MAY-1010A	Field coil and brush assembly—U.R.	-	-	1	-	-
MAY-1033	Connector and brush assembly	-	-	1	-	-
MAY-12A	Brush—long pigtail	-	-	2	-	-
MN-21	Dowel pin	-	-	2	-	-
MU-37	3/16 plain washer	-	-	1	-	-
8X-61	No. 10-32 x 5/16 flat hd. screw	-	-	2	-	-
X-1014	5/16 lockwasher	-	-	1	-	-
8X-1376	5/16-24 hex. nut	-	-	1	-	-
MW-20B	Frame screw	-	-	2	-	-
X-199	1/4 lockwasher	-	-	2	-	-
X-1014	5/16 lockwasher	-	-	1	-	-
8X-1376	5/16-24 hex. nut	-	-	1	-	-

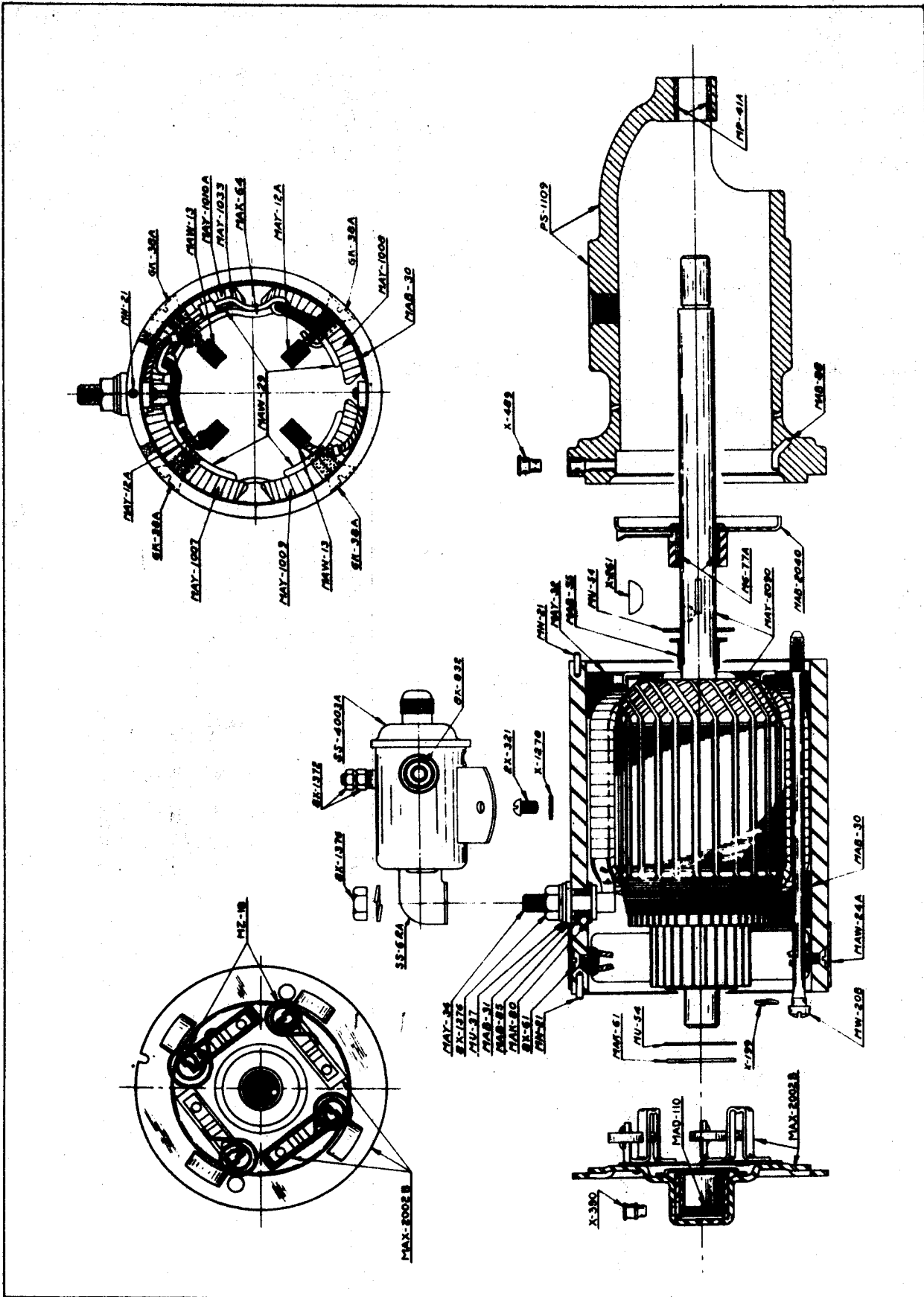

SERVICE PARTS LIST—PACKARD SUPER-EIGHT AND TWELVE

Starter Motor and Switch 171

Piece No.	Name	1500	1506	1603	1607	1707	
		1501	1507	1604	1608	1708	
		1502	1508	1605	No. Required		

Commutator End Plate Assembly

MAX-2002B	Commutator end plate assembly	-	-	1	-	-
MAD-110	Felt pad	-	-	1	-	-
MZ-19	Brush spring	-	-	4	-	-
X-390	Oiler—1/4 hinged top	-	-	1	-	-

Armature Assembly

MAK-61	5/8 steel washer	-	-	1	-	-
MAY-2090	Armature assembly	-	-	1	-	-
MAB-35	Bearing thrust spacer	-	-	1	-	-
MU-54	Thrust washer—1/32" thick	-	-	2	-	-
X-261	No. 6 Woodruff Key	-	-	1	-	-

Switch Assembly

SS-6RA	Connector	-	-	1	-	-
SS-4003A	Solenoid starting switch	-	-	1	-	-
12X-196	No. 10 lockwasher	-	-	1	-	-
8X-832	5/16-24 hex. nut	-	-	1	-	-
12X-1014	5/16 lockwasher	-	-	1	-	-
8X-1372	No. 10-32 hex. nut	-	-	1	-	-
2X-321	No. 10-32 x 5/16 rnd. hd. screw	-	-	2	-	-
8X-832	5/16-24 hex. nut	-	-	1	-	-
12X-1014	5/16 lockwasher	-	-	1	-	-
X-1270	No. 10 (Shakeproof) washer	-	-	2	-	-

Miscellaneous Parts

EBA-12	Bendix drive assembly	-	-	1	-	-
MAB-2040	Intermediate bearing assembly	-	-	1	-	-
MG-77A	Absorbent bronze bearing	-	-	1	-	-
MAW-24A	Head band	-	-	1	-	-
PS-1109	Pinion housing assembly	-	-	1	-	-
MAB-88	Dowel pin	-	-	1	-	-
MP-41A	Absorbent bronze bearing	-	-	1	-	-
X-489	1/4 oiler—press in type	-	-	1	-	-
2X-715	No. 10-32 x 1-1/4 rnd. hd. screw	-	-	1	-	-
2X-794	No. 10-32 square nut	-	-	1	-	-

Piece No.	Name	1500	1506	1603	1607	1707
		1501	1507	1604	1608	1708
		1502	1508	1605		
		No. Required				

MOTOR STARTER MOTOR AND MAGNETIC SWITCH
(Delco Type No. 664)

The following parts are listed with the manufacturers' piece numbers and are to be ordered by these numbers. Dealers should order these parts through their distributor.

D-1866085	Frame and field assembly	-	X	-	-	-
D-36497	Pole shoe	-	X	-	-	-
D-1866065	Pole shoe screw	-	X	-	-	-
D-1866087	Terminal stud	-	X	-	-	-
D-1861076	Terminal stud ins. washer (3/4 O.D.)	-	X	-	-	-
D-809051	Terminal stud ins. washer (9/16 O.D.)	-	X	-	-	-
D-1866089	Terminal stud plain washer	-	X	-	-	-
D-1866088	Terminal stud nut (5/32 thick)	-	X	-	-	-
D-1866011	Terminal stud nut (1/4 thick)	-	X	-	-	-
D-1866009	Terminal stud nut lockwasher	-	X	-	-	-
D-16818	Field coil assembly (2 coils--opposite stud)	-	X	-	-	-
D-16819	Field coil assembly (2 coils--right of stud)	-	X	-	-	-
D-16820	Field coil assembly (2 coils--left of stud)	-	X	-	-	-
D-33345	Field coil ins. strip	-	X	-	-	-
D-1866090	Armature	-	X	-	-	-
D-1866094	Commutator band	-	X	-	-	-
D-1866098	Commutator end frame	-	X	-	-	-
D-110794	Brush holder rivet	-	X	-	-	-
D-24754	Brush holder rivet plain washer	-	X	-	-	-
D-35728	Brush holder rivet ins. bushing washer	-	X	-	-	-
D-1860389	Brush holder rivet ins. washer	-	X	-	-	-
D-1839345	Bushing (C.E.)	-	X	-	-	-
D-810819	End plug (C.E.)	-	X	-	-	-
D-16083	Brush	-	X	-	-	-
D-34846	Brush spring	-	X	-	-	-
D-115607	Brush lead attaching screw	-	X	-	-	-
D-141551	Brush lead attaching screw lockwasher	-	X	-	-	-
D-1838568	Space washer (C.E.)	-	X	-	-	-
D-37872	C.E. frame attaching screw	-	X	-	-	-
D-115693	C.E. frame attaching screw lockwasher	-	X	-	-	-
D-820149	Center bearing plate	-	X	-	-	-
D-820148	Center bearing bushing	-	X	-	-	-
D-142210	Center bearing attaching screw	-	X	-	-	-
D-802731	Center bearing attaching screw lockwasher	-	X	-	-	-
D-1866093	Motor drive housing	-	X	-	-	-
D-1839345	Motor drive housing bushing	-	X	-	-	-
D-37872	Motor drive housing attaching screw	-	X	-	-	-
D-115693	Motor drive housing attaching screw L.W.	-	X	-	-	-
D-124546	Woodruff key	-	X	-	-	-
D-1541	Magnetic switch	-	X	-	-	-
D-1866097	Magnetic switch mounting screw	-	X	-	-	-
D-116131	Magnetic switch mounting screw L.W.	-	X	-	-	-
D-1866096	Magnetic switch connector strap	-	X	-	-	-
D-1866095	Motor drive assembly	-	X	-	-	-

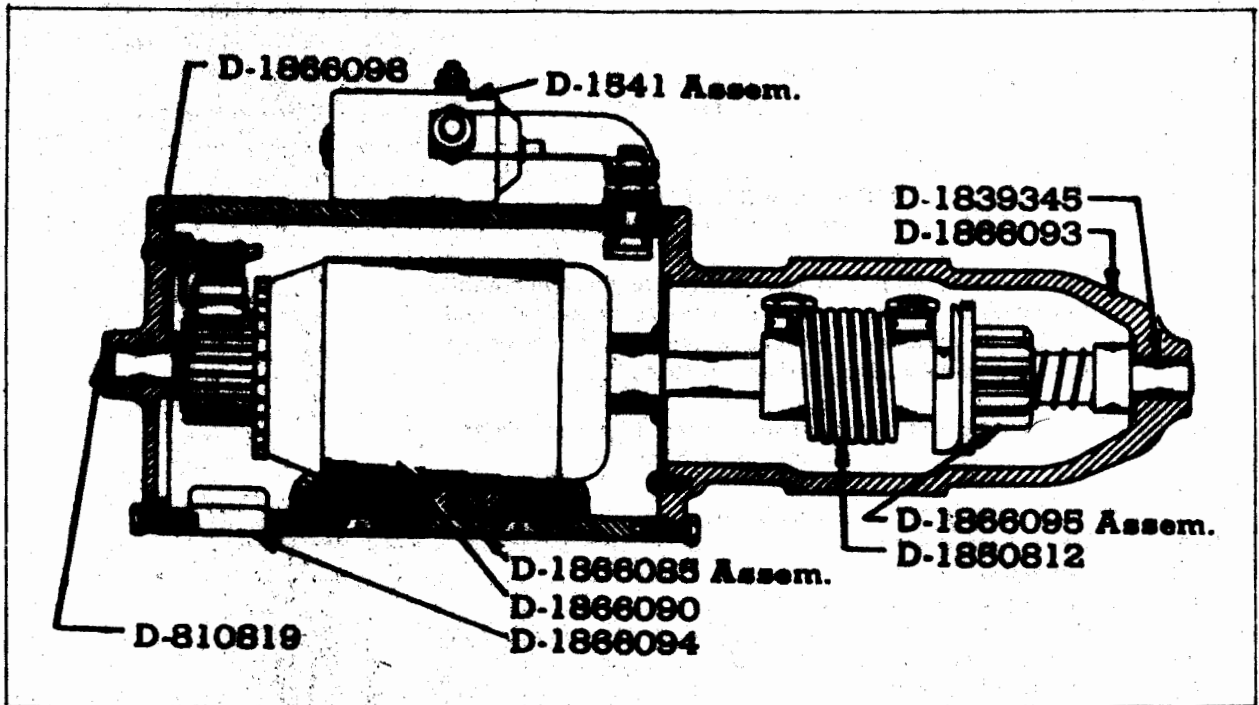

Models 1506-7-8

Piece No.	Name	1500	1506	1603	1607	1707
		1501	1507	1604	1608	1708
		1502	1508	1605	No. Required	
D-186612	Gear and shaft assembly	-	X	-	-	-
D-1849782	Service sleeve	-	X	-	-	-
D-1848530	Drive head	-	X	-	-	-
D-1850812	Drive spring	-	X	-	-	-
D-1850811	Head spring screw	-	X	-	-	-
D-1850810	Shaft spring screw	-	X	-	-	-
D-805057	Lockwasher	-	X	-	-	-
D-1866011	Terminal stud nut (3/8-16 x 1/4 thick)	-	X	-	-	-
D-1866009	Terminal stud nut lockwasher (3/8)	-	X	-	-	-
D-1866010	Terminal stud nut plain washer (.380 I.D.) ..	-	X	-	-	-
D-1866017	Terminal stud nut (8-32)	-	X	-	-	-
D-1866016	Terminal stud nut lockwasher (No. 8)	-	X	-	-	-

Piece No.	Name	1500	1506	1603	1607	1707	
		1501	1507	1604	1608	1708	
		1502	1508	1605	No. Required		

MOTOR STARTER MOTOR
(Electric Auto-Lite No. DN-1389)

The following parts are listed with the manufacturers' piece numbers and are to be ordered by these numbers. Dealers should order these parts through their distributor.

**Frame and Field Assembly With Terminal Post
and Parts Used With**

13617	Field connection insulation	-	1	-	1	1
14L05	5/16 lockwasher	-	1	-	1	1
13389	Terminal washer	-	2	-	2	2
13391	5/16-18 hex. nut	-	1	-	1	1
13622	Pole piece	-	6	-	6	6
13626	Field coil assembly--comp.	-	1	-	1	1
13701	Insulating washer	-	2	-	2	2
13702	Insulating bushing	-	1	-	1	1
13915	Field connection insulation	-	1	-	1	1
16135	Terminal post	-	1	-	1	1
14205410	Pole piece screw	-	2	-	2	2
14305410	Pole piece screw	-	10	-	10	10

Commutator End Head Assembly and Parts Used With

14L60	No. 10 lockwasher	-	2	-	2	2
13592	Brush--short pigtail	-	3	-	3	3
13593	Brush--long pigtail	-	1	-	1	1
13627	Commutator end head assembly	-	1	-	1	1
12N1600	No. 10-32 hex. nut	-	2	-	2	2
13576	Absorbent bronze bearing	-	1	-	1	1
13980	Brush holder plate assembly	-	1	-	1	1
13979	Brush spring	-	4	-	4	4
22169	No. 10 lockwasher	-	2	-	2	2
22549	Dowel pin	-	1	-	1	1
12160010	No. 10-32 x 5/8 rnd. hd. screw	-	2	-	2	2
13629	Cover	-	1	-	1	1
16398	No. 10-32 x 3/8 bdg. hd. screw	-	1	-	1	1
20053	No. 10 (Shakeproof) washer	-	1	-	1	1
14204308	1/4-20 x 1/2 flat hd. screw	-	3	-	3	3
20160004	No. 10-32 x 1/4 rnd. hd. screw	-	2	-	2	2
24158005	No. 8-32 x 5/16 rnd. hd. screw	-	1	-	1	1

Armature Assembly and Parts Used With

13170	Thrust washer	-	4	-	4	4
13348	No. 6 Woodruff Key	-	1	-	1	1
13409	Armature assembly	-	1	-	1	1

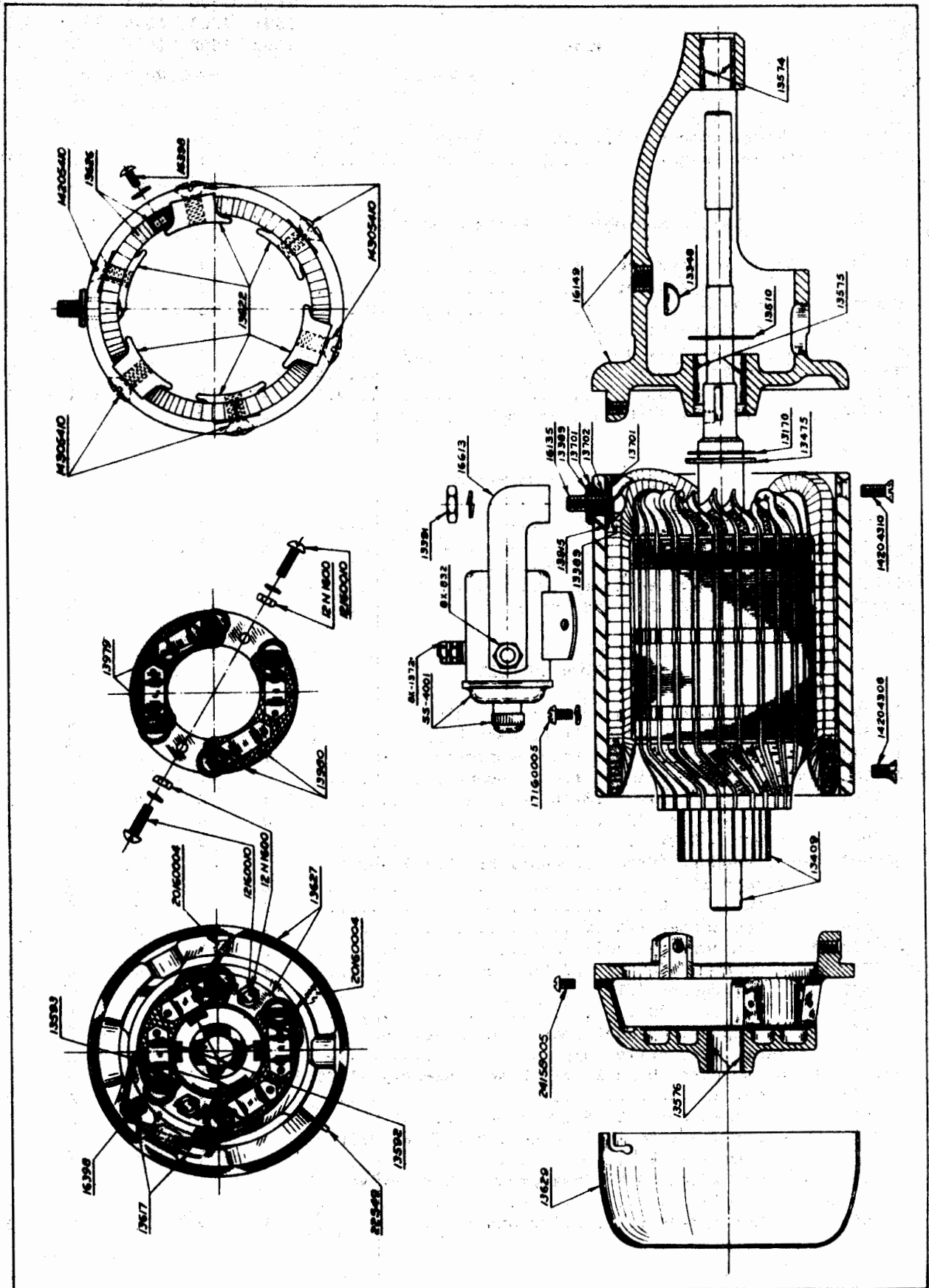

Models 1506-7-8, 1607-8, 1707-8

Piece No.	Name	1500	1506	1603	1607	1707
		1501	1507	1604	1608	1708
		1502	1508	1605	No. Required	

13475	Thrust washer	-	1	-	1	1
13510	Thrust washer	-	1	-	1	1

Switch Assembly, and Parts Used With

SS-4001	Solenoid starting switch	-	1	-	1	1
12X-196	No. 10 lockwasher	-	1	-	1	1
8X-832	5/16-24 hex. nut	-	2	-	2	2
12X-1014	5/16 lockwasher	-	2	-	2	2
8X-1372	No. 10-32 hex. nut	-	1	-	1	1
16613	Connector	-	1	-	1	1
22169	No. 10 lockwasher	-	2	-	2	2
17160005	No. 10-32 x 5/16 rnd. hd. screw	-	2	-	2	2

Miscellaneous Parts

16149	Pinion housing assembly	-	1	-	1	1
13574	Absorbent bronze bearing	-	1	-	1	1
13575	Absorbent bronze bearing	-	1	-	1	1
16511	Bendix drive assembly	-	1	-	1	1
14204310	1/4-20 x 5/8 flat hd. screw	-	3	-	3	3

MOTOR SUPPORT

232292	Motor support channel front assembly	-	1	-	-	-
240502	Motor support channel front assembly	-	-	1	-	-
231444	Motor support channel front assembly	1	-	-	-	-
240066	Motor support channel front assembly	-	-	-	1	1
5958	Screw 3/8-24 x 13/16 hex. hd.	4	4	2	2	2
5506	Lockwasher 3/8	4	4	2	2	2
7006	Nut 3/8-24	4	4	-	-	-
300903	Motor support (front) channel bracket lower to frame bolt	2	-	2	-	-
7008	Nut 1/2-20	2	-	2	-	-
5510	Lockwasher 1/2	2	-	2	-	-
232133	Motor support channel rear	1	1	1	1	1
7952	Screw 7/16-20 x 7/8 hex. hd.	4	4	4	4	4
5508	Lockwasher 7/16	4	4	4	4	4
7007	Nut 7/16-20	4	4	4	4	4
232152	Motor support channel rear brace assembly-- right (L.H. drive only)	1	1	1	1	1
237219	Motor support channel rear brace assembly--left 7008 Nut 1/2-20	-	1	-	1	1
6047	Lockwasher 1/2 (Shakeproof)	-	2	-	2	2
7823	Screw 3/8-24 x 15/16 hex. hd. (L.H. drive only)	-	1	-	1	1
6048	Lockwasher 3/8 (Shakeproof) (L.H. drive only)	1	2	1	2	2
7006	Nut 3/8-24 (L.H. drive only)	1	2	1	2	2

SERVICE PARTS LIST—PACKARD SUPER-EIGHT AND TWELVE

Motor Vacuum Check Valve 177

Piece No.	Name	1500	1506	1603	1607	1707	
		1501	1507	1604	1608	1708	
		1502	1508	1605	No. Required		
234838	Motor support channel rear brace left spacer ..	-	1	-	1	1	
232132	Motor support channel rear bracket--left	1	1	1	1	1	
232139	Motor support channel rear bracket--right	1	1	1	-	-	
5958	Screw 3/8-24 x 13/16 hex. hd.	12	12	12	12	12	
5506	Lockwasher 3/8	12	12	12	12	12	
7006	Nut 3/8-24	12	12	12	12	12	
207542	Motor support rear insulator assembly	2	2	2	2	2	
7846	Screw 3/8-24 x 2-5/8 hex. hd.	5	4	5	4	4	
7844	Screw 3/8-24 x 2-7/8 hex. hd. (R.H. drive)	-	-	2	4	4	
5506	Lockwasher 3/8	5	4	5	4	4	
7006	Nut 3/8-24	5	4	5	4	4	
3877	Washer 3/8	2	2	2	2	2	
5506	Motor support rear insulator upper bolt lock- washer 3/8	4	4	4	4	4	
7006	Nut 3/8-24	4	4	4	4	4	
207657	Motor support rear insulator bracket	2	2	-	-	-	
240153	Motor support rear insulator bracket--right ...	-	-	1	1	1	
240152	Motor support rear insulator bracket--left	-	-	1	1	1	
5506	Lockwasher 3/8	8	8	8	8	8	
7006	Nut 3/8-24	8	8	8	8	8	
3877	Washer 3/8	1	1	1	1	1	
207661	Motor support rear insulator spacer	2	2	2	2	2	

MOTOR VACUUM CHECK VALVE

221035	Motor vacuum check valve assembly	-	1	-	1	1
221036	Motor vacuum check valve body and tube assembly	-	1	-	1	1
202573	Motor vacuum check valve body to manifold stud 1/4-28 x 1-1/8	-	3	-	3	3
5447	Lockwasher 1/4 (Shakeproof)	-	3	-	3	3
7004	Nut 1/4-28	-	3	-	3	3
202572	Motor vacuum check valve body to manifold gasket	-	1	-	1	1
219997	Motor vacuum check valve and cover assembly ...	-	1	-	1	1
5822	Screw 1/4-28 x 5/8 hex. hd.	-	4	-	4	4
5502	Lockwasher 1/4	-	4	-	4	4
225614	Motor vacuum check valve cover gasket	-	1	-	1	1
203178	Motor vacuum check valve tube to dash con- nection union	-	1	-	1	1
203177	Motor vacuum check valve tube to dash con- nection union nut	-	1	-	1	1
237558	Motor vacuum check valve to vacuum pump tube assembly	-	1	-	1	1
6657	Motor vacuum check valve to vacuum pump tube elbow 5/16 flared tube inverted weatherhead .	-	1	-	1	1
6258	Connector 5/16 flared tube inverted weatherhead	-	1	-	1	1
6262	Nut 5/16 flared tube inverted weatherhead.	-	2	-	2	2

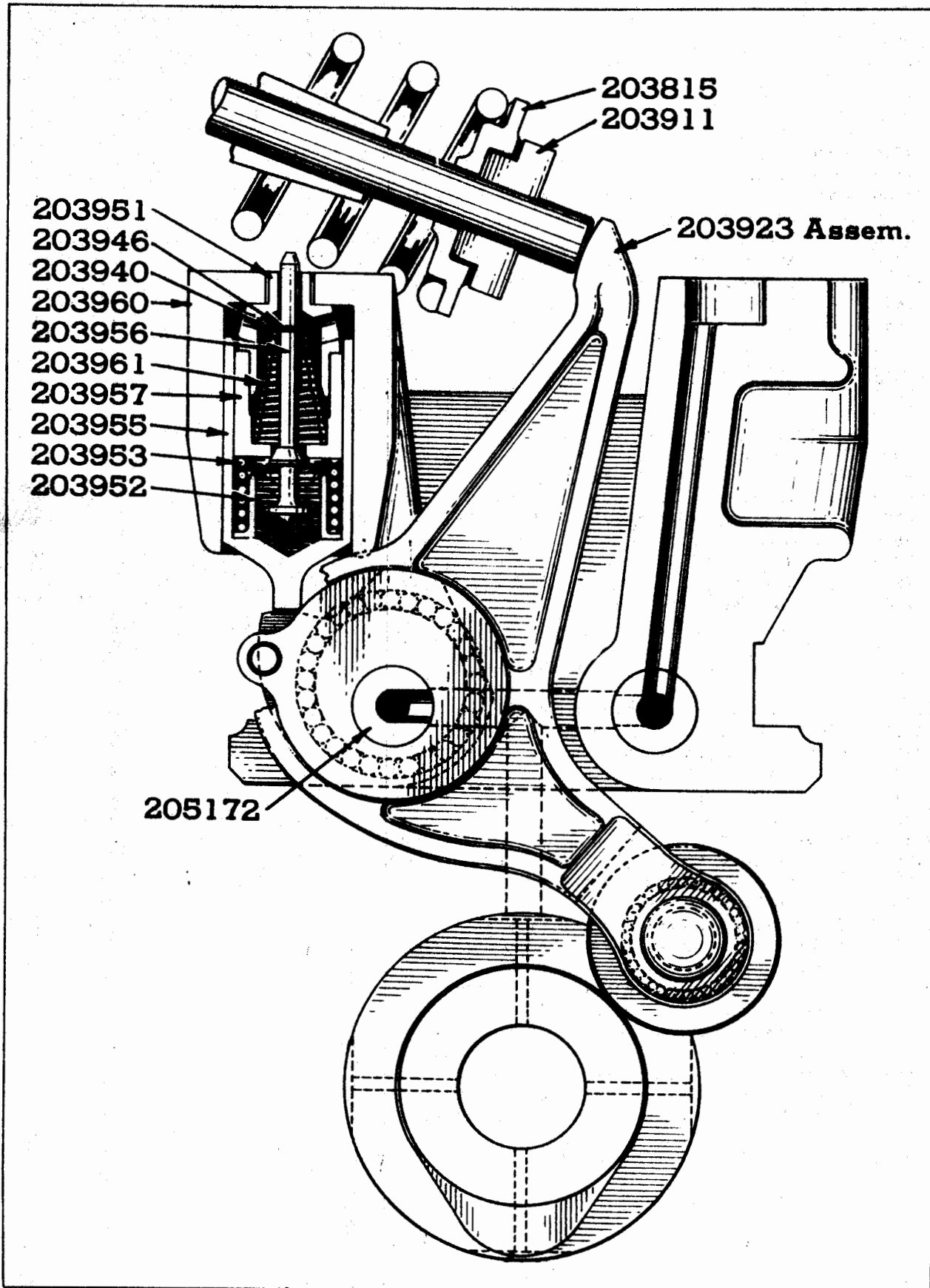

SERVICE PARTS LIST--PACKARD SUPER-EIGHT AND TWELVE

Motor Valve 179

Piece No.	Name	1500	1506	1603	1607	1707-	
		1501	1507	1604	1608	1708	
		1502	1508	1605	No. Required		
MOTOR VALVE							
219286	Motor valve-exhaust	8	-	8	-	-	
219591	Motor valve-exhaust	-	12	-	12	12	
219284	Motor valve-inlet	8	-	8	-	-	
203806	Motor valve-inlet	-	12	-	12	12	
205042	Motor valve chamber breather	-	1	-	1	1	
205043	Motor valve chamber breather baffle	-	1	-	1	1	
201946	Motor valve chamber breather baffle stud	-	2	-	2	2	
3874	Washer 5/16	-	2	-	2	2	
5504	Lockwasher 5/16	-	2	-	2	2	
7005	Nut 5/16-24	-	2	-	2	2	
197638	Motor valve chamber breather gasket	-	1	-	1	1	
215465	Motor valve cover assembly	2	-	-	-	-	
219967	Motor valve cover assembly	-	1	-	1	1	
240735	Motor valve cover (front) assembly	-	-	1	-	-	
215465	Motor valve cover (rear) assembly	-	-	1	-	-	
5391	Screw (long) 5/16-18 x 1-1/4 hex. hd.	-	1	-	1	1	
6185	Screw (short) 5/16-18 x 5/8 hex. hd.	-	8	-	8	8	
6044	Lockwasher 5/16 (Shakeproof)	-	9	-	9	9	
215467	Motor valve cover gasket	2	-	2	-	-	
219969	Motor valve cover gasket	-	1	-	1	1	
219968	Motor valve cover gasket retainer	-	1	-	1	1	
201052	Motor valve cover gasket retainer rivet	-	12	-	12	12	
240745	Motor valve cover (front) stud	-	-	2	-	-	
240185	Motor valve cover (rear) stud	-	-	2	-	-	
215470	Motor valve cover stud	4	-	-	-	-	
201677	Motor valve cover stud nut	4	-	4	4	4	
110576	Motor valve cover stud nut gasket	4	-	4	4	4	
240740	Motor valve cover ventilator tube assembly	-	-	1	-	-	
240742	Motor valve cover ventilator tube bracket	-	-	1	-	-	
5471	Screw 1/4-28 x 3/4 hex. hd.	-	-	1	-	-	
5502	Lockwasher 1/4	-	-	1	-	-	
7004	Nut 1/4-28	-	-	1	-	-	
240743	Motor valve cover ventilator tube clamp	-	-	1	-	-	
132177	Motor valve push rod	16	-	16	-	-	
170088	Motor valve push rod guide	16	-	16	-	-	
132179	Motor valve push rod screw	16	-	16	-	-	
300684	Motor valve push rod screw nut	16	-	16	-	-	
205176	Motor valve silencer bracket and rocker lever assembly	-	3	-	3	3	
203960	Motor valve silencer bracket	-	3	-	3	3	
6190	Stud 1/2-20 x 4-3/4 special	-	8	-	8	8	
5510	Lockwasher 1/2	-	8	-	8	8	
7008	Nut 1/2-20	-	8	-	8	8	
203954	Motor valve silencer bracket retaining clamp-end	-	2	-	2	2	
203950	Motor valve silencer bracket retaining clamp-- center	-	2	-	2	2	
203952	Motor valve silencer dash pot	-	24	-	24	24	
203955	Motor valve silencer piston	-	24	-	24	24	
203953	Motor valve silencer piston spring	-	24	-	24	24	
203956	Motor valve silencer valve	-	24	-	24	24	

180 Motor Water Pump

SERVICE PARTS LIST—PACKARD SUPER-EIGHT AND TWELVE

Piece No.	Name	1500	1506	1603	1607	1707
		1501	1507	1604	1608	1708
		1502	1508	1605	No. Required	
203951	Motor valve silencer valve guide	-	24	-	24	24
203957	Motor valve silencer valve seat	-	24	-	24	24
203961	Motor valve silencer valve spring	-	24	-	24	24
203940	Motor valve silencer valve spring retainer	-	24	-	24	24
203946	Motor valve silencer valve spring retainer lock ring	-	24	-	24	24
147289	Motor valve spring assembly	16	-	16	-	-
201860	Motor valve spring	-	24	-	24	24
203808	Motor valve spring seat—upper	-	24	-	-	-
239755	Motor valve spring seat—upper	-	-	-	24	24
203815	Motor valve spring seat—lower	-	24	-	24	24
203911	Motor valve spring seat key	-	24	-	24	24
147294	Motor valve spring seat key—special	16	-	16	-	-
215481	Motor valve stem guide	16	-	16	-	-
239756	Motor valve stem guide (Supersedes 197754)	-	24	-	24	24
197639	Motor valve stem guide lock ring	-	24	-	24	24

MOTOR VIBRATION DAMPER

210647	Motor vibration damper assembly	1	-	1	-	-
219921	Motor vibration damper assembly	-	1	-	1	1
183761	Motor vibration damper dowel pin	6	6	6	6	6
195916	Motor vibration damper flywheel assembly—front half	1	1	1	1	1
195917	Motor vibration damper flywheel assembly—rear half	1	-	1	-	-
219957	Motor vibration damper flywheel assembly—rear half	-	1	-	1	1
195903	Motor vibration damper flywheel bushing	2	2	2	2	2
183770	Motor vibration damper flywheel clamp screw	6	6	6	6	6
5504	Lockwasher 5/16	6	6	6	6	6
190472	Motor vibration damper flywheel spring	-	12	-	12	12
210629	Motor vibration damper flywheel spring	12	-	12	-	-
183763	Motor vibration damper friction disc	2	2	2	2	2
183764	Motor vibration damper friction plate	2	2	2	2	2
185416	Motor vibration damper friction plate spacer	1	1	1	1	1
195919	Motor vibration damper hub assembly	1	-	1	-	-
197766	Motor vibration damper hub assembly	-	1	-	1	1
183759	Motor vibration damper hub spacer	1	-	1	-	-
197698	Motor vibration damper hub spacer	-	1	-	1	1
183758	Motor vibration damper key	1	-	1	-	-

MOTOR WATER PUMP

240200	Motor water pump assembly	-	-	1	-	-
240060	Motor water pump assembly	-	-	-	1	1
232153	Motor water pump assembly	1	-	-	-	-
219958	Motor water pump assembly	-	1	-	-	-
232893	Motor water pump body	1	-	-	-	-
240158	Motor water pump body	-	-	1	-	-

SERVICE PARTS LIST—PACKARD SUPER-EIGHT AND TWELVE

Motor Water Pump 181

Piece No.	Name	1500	1506	1603	1607	1707
		1501	1507	1604	1608	1708
		1502	1508	1605	No. Required	
219820	Motor water pump body	-	1	-	1	1
232052	Motor water pump body gasket	1	-	1	-	-
219959	Motor water pump body gasket	-	1	-	1	1
221005	Motor water pump body to gear cover inlet hose.	-	1	-	1	1
201218	Motor water pump body to gear cover inlet hose clamp	-	2	-	2	2
175911	Motor water pump stud	5	-	5	-	-
5385	Lockwasher 5/16 (Shakeproof)	5	-	5	-	-
7005	Nut 5/16-24	5	-	5	-	-
203280	Motor water pump felt	-	5	3	5	5
232068	Motor water pump felt	4	-	-	-	-
219254	Motor water pump felt	-	-	1	-	-
232072	Motor water pump felt retainer	2	-	-	-	-
203269	Motor water pump felt retainer	-	2	2	2	2
117970	Motor water pump impeller screw	1	1	1	1	1
300072	Motor water pump oil cup	1	-	1	-	-
184722	Motor water pump oil cup	-	1	-	1	1
197720	Motor water pump outlet sleeve	-	2	-	2	2
197706	Motor water pump outlet sleeve gasket	-	2	-	2	2
197820	Motor water pump retaining stud—short	-	2	-	2	2
201894	Motor water pump retaining stud—long	-	4	-	4	4
7006	Nut 3/8-24	-	6	-	6	6
5506	Lockwasher 3/8	-	6	-	6	6
232058	Motor water pump shaft bearing	2	-	-	-	-
202953	Motor water pump shaft bearing .NO. 3504.....	-	2	2	2	2
232053	Motor water pump shaft bearing retainer	1	-	-	-	-
203275	Motor water pump shaft bearing retainer	-	1	1	1	1
5687	Screw 1/4-28 x 5/8 fill. hd.	3	4	4	4	4
5447	Lockwasher 1/4 (Shakeproof)	3	4	4	4	4
232129	Motor water pump shaft bearing retaining ring .	1	-	-	-	-
203286	Motor water pump shaft bearing retainer gasket.	-	x	x	x	x
216631	Motor water pump shaft bearing retainer gasket.	-	x	x	x	x
232063	Motor water pump shaft bearing spacer	1	-	-	-	-
240182	Motor water pump shaft bearing spacer	-	-	1	-	-
221084	Motor water pump shaft bearing spacer	-	1	-	1	1
232898	Motor water pump shaft impeller and fan pulley assembly	1	-	-	-	-
240197	Motor water pump shaft impeller and fan pulley assembly	-	-	1	-	-
221076	Motor water pump shaft impeller and fan pulley assembly	-	1	-	-	-
240062	Motor water pump shaft impeller and fan pulley assembly	-	-	-	1	1
0231176	Motor water pump shaft packing	-	x	x	x	x
0242941	Motor water pump shaft packing	x	-	-	-	-
232895	Motor water pump shaft packing nut	1	-	-	-	-
203460	Motor water pump shaft packing nut	-	1	1	1	1

Piece No.	Name	1500	1506	1603	1607	1707
		1501	1507	1604	1608	1708
		1502	1508	1605	No. Required	

PATENT PLATE

133933	Packard patent plate	1	1	-	-	-
324418	Packard patent plate	-	-	1	1	-
335494	Packard patent plate	-	-	-	-	1
5984	Screw No. 6 x 3/8 rnd. hd. (Parker Kalon).	4	4	4	4	4

RADIATOR

237420	Radiator assembly	1	-	-	-	-
237421	Radiator assembly	-	1	-	-	-
230450	Radiator bonnet ledge liner	2	2	-	-	-
187260	Radiator bonnet ledge liner hook	4	4	-	-	-
7002	Nut No. 8-32	4	4	-	-	-
191654	Radiator bonnet ledge liner hook saddle	2	2	-	-	-
215091	Radiator cap assembly	1	1	-	-	-
215090	Radiator cap bail	1	1	-	-	-
203782	Radiator cap bail set screw	1	1	-	-	-
203803	Radiator cap gasket	1	1	-	-	-
203809	Radiator cap gasket spring	1	1	-	-	-
194829	Radiator cap lock plate	1	1	-	-	-
6229	Screw 5/16-18 x 1/2 hex. hd.	1	1	-	-	-
5504	Lockwasher 5/16	1	1	-	-	-
6359	Washer 5/16 special	1	1	-	-	-
194831	Radiator cap lock plate gasket	1	1	-	-	-
237218	Radiator core and anchorage assembly	1	-	-	-	-
237904	Radiator core and anchorage assembly	-	1	-	-	-
223742	Radiator core and anchorage cradle assembly ...	1	-	-	-	-
223740	Radiator core and anchorage cradle assembly ...	-	1	-	-	-
7007	Radiator core and anchorage to cradle bolt nut 7/16 standard	2	2	-	-	-
5508	Lockwasher 7/16	2	2	-	-	-
3883	Washer plain 7/16 "N" standard	2	2	-	-	-
223236	Radiator core and anchorage cradle brace	1	1	-	-	-
7608	Bolt 5/16-24 x 3/4 carriage	4	4	-	-	-
5504	Lockwasher 5/16	4	4	-	-	-
7005	Nut 5/16-24	4	4	-	-	-
223242	Radiator core and anchorage cradle brace lock .	1	1	-	-	-
221953	Radiator core and anchorage cradle to frame bolt	1	1	-	-	-
231438	Radiator core and anchorage cradle to frame bolt spacer--upper	1	1	-	-	-
221978	Radiator core and anchorage cradle to frame bolt spacer--lower	1	1	-	-	-
221981	Radiator core and anchorage cradle to frame bolt washer	1	1	-	-	-
7108	Nut 1/2-20 castle	1	1	-	-	-
4291	Cotter pin 3/32 x 3/4	1	1	-	-	-
223265	Radiator core and anchorage cradle liner	1	1	-	-	-
223472	Radiator core to shell liner side	2	2	-	-	-
194894	Radiator core to shell liner top	2	2	-	-	-
223473	Radiator core to shell liner--top center	1	1	-	-	-

NOTE: SEE SERVICE BULLETINS FOR RADIATOR CORE EXCHANGES.

SERVICE PARTS LIST--PACKARD SUPER-EIGHT AND TWELVE

Radiator 183

Piece No.	Name	1500	1506	1603	1607	1707
		1501	1507	1604	1608	1708
		No. Required				
230307	Radiator to dash tie rod--right	1	-	-	-	-
230305	Radiator to dash tie rod--left	1	-	-	-	-
230306	Radiator to dash tie rod	-	2	-	-	-
5394	Bolt 3/8-24 x 1-1/2 hex. hd.	1	1	-	-	-
7006	Nut 3/8-24	1	1	-	-	-
5506	Lockwasher 3/8	1	1	-	-	-
7008	Nut 1/2-20	4	4	-	-	-
6047	Lockwasher 1/2 (Shakeproof)	2	2	-	-	-
3886	Plain washer 5/16 special	4	4	-	-	-
232806	Radiator drain cock	-	1	-	-	-
232807	Radiator drain cock outlet tube assembly	-	1	-	-	-
6475	Nut 5/16 flared tube inverted	-	1	-	-	-
225397	Radiator expansion tank assembly	-	1	-	-	-
6679	Radiator expansion tank connection tube lock- washer 11/16	-	1	-	-	-
190680	Nut 11/16-16 special	-	1	-	-	-
6669	Radiator expansion tank to core tube connector 7/16 flared-inverted	-	1	-	-	-
5421	Radiator expansion tank drain hose plug 1/8 pipe	-	1	-	-	-
225436	Radiator expansion tank to radiator tube hose	-	1	-	-	-
205975	Radiator expansion tank to radiator tube hose clamp	-	2	-	-	-
5449	Radiator expansion tank retaining screw 5/16-24 x 3/4 hex. hd.	-	2	-	-	-
5504	Lockwasher 5/16	-	2	-	-	-
7005	Nut 5/16-24	-	2	-	-	-
232841	Radiator expansion tank tube assembly--front ..	-	1	-	-	-
232840	Radiator expansion tank tube assembly--rear ...	-	1	-	-	-
6670	Radiator expansion tank tube--front nut 7/16 flared inverted	-	1	-	-	-
6235	Radiator expansion tank tube--rear union nut 7/16 flared	-	1	-	-	-
162552	Radiator expansion tank tube clip	-	1	-	-	-
303939	Radiator expansion tank tube clip sorew (washer type) 5/16-18 x 1/2 hex. hd.	-	1	-	-	-
223504	Radiator fan shroud assembly	-	1	-	-	-
7713	Screw 1/4-28 x 1/2 fill. hd.	-	6	-	-	-
7004	Nut 1/4-28	-	4	-	-	-
5502	Lockwasher 1/4	-	6	-	-	-
62065	Washer 1/4" special	-	2	-	-	-
223522	Radiator hose (inlet)	1	-	-	-	-
205680	Radiator hose (inlet)--long	-	1	-	-	-
205679	Radiator hose (inlet)--short	-	1	-	-	-
232034	Radiator hose (outlet)	1	-	-	-	-
219933	Radiator hose (outlet)	-	1	-	-	-
203083	Radiator hose clamp	4	-	-	-	-
142989	Radiator hose clamp--small	-	4	-	-	-
201218	Radiator hose clamp--large	-	2	-	-	-
207286	Radiator hose spring--small	-	2	-	-	-
223503	Radiator hose spring--large	-	1	-	-	-
202188	Radiator overflow tube hose	1	-	-	-	-
231380	Radiator shell assembly	1	1	-	-	-

Piece No.	Name	1500	1506	1603	1607	1707	
		1501	1507	1604	1608	1708	
		1502	1508	1605	No. Required		
230179	Radiator shell center bar	1	1	-	-	-	
8201	Radiator shell to core and anchorage assembly screw 1/4-28 x 5/8 flat hd.	4	4	-	-	-	
5701	Screw 1/4-28 x 9/16 flat hd.	2	2	-	-	-	
6488	Screw 1/4-28 x 5/8 flat hd.	4	4	-	-	-	
5502	Lockwasher 1/4	6	6	-	-	-	
3868	Washer 1/4	6	6	-	-	-	
7004	Nut 1/4-28	6	6	-	-	-	
5396	Lockwasher 1/4 (Shakeproof)	4	4	-	-	-	
213192	Radiator shell emblem	1	-	-	-	-	
210121	Radiator shell emblem	-	1	-	-	-	
239617	Radiator shell emblem nut 1/4-20	1	1	-	-	-	
239618	Radiator shell emblem washer 1/4	1	1	-	-	-	
5447	Lockwasher 1/4 (Shakeproof)	1	1	-	-	-	
232055	Radiator shell to fender liner	1	1	-	-	-	
6497	Rivet 9/64 x 3/16 flat hd. tubular	8	8	-	-	-	
201669	Radiator shell to thimble gasket	1	1	-	-	-	
231442	Radiator shutter assembly	1	1	-	-	-	
5739	Radiator shutter (bell crank bracket) to core screw No. 10-32 x 1/2 hex. hd.	1	1	-	-	-	
5500	Lockwasher No. 10	1	1	-	-	-	
3866	Washer 3/16 plain	1	1	-	-	-	
5427	Radiator shutter to core and cradle bolt	6	6	-	-	-	
5385	Lockwasher 5/16 (Shakeproof)	6	6	-	-	-	
3874	Washer 5/16 plain	6	6	-	-	-	
5573	Radiator shutter to radiator shell screw No. 10-32 x 1/2 flat hd. special	4	4	-	-	-	
7003	Nut No. 10-32	4	4	-	-	-	
5500	Lockwasher No. 10	4	4	-	-	-	
231456	Radiator shutter blade assembly--left center ..	7	7	-	-	-	
231457	Radiator shutter blade assembly--right center .	7	7	-	-	-	
231462	Radiator shutter blade assembly--left end	1	1	-	-	-	
231463	Radiator shutter blade assembly--right end	1	1	-	-	-	
231468	Radiator shutter blade bearing assembly--lower.	2	2	-	-	-	
230365	Radiator shutter blade bearing assembly--upper.	2	2	-	-	-	
230367	Radiator shutter operating bar and stud assy. .	2	2	-	-	-	
4690	Cotter pin 1/16 x 3/8	2	2	-	-	-	
230362	Radiator shutter operating link--left	1	1	-	-	-	
230363	Radiator shutter operating link--right	1	1	-	-	-	
225136	Radiator shutter operating link--left center ..	1	1	-	-	-	
230364	Radiator shutter operating link--right center .	1	1	-	-	-	
225105	Radiator shutter operating link bell crank and bushing assembly	1	1	-	-	-	
225111	Radiator shutter operating link screw	2	2	-	-	-	
6056	Lockwasher No. 10 (Shakeproof)	2	2	-	-	-	
230429	Radiator shutter operating rod and yoke end assembly	1	1	-	-	-	
225132	Radiator shutter operating rod bell crank	1	1	-	-	-	
225123	Radiator shutter operating rod bell crank pin .	1	1	-	-	-	
4280	Cotter pin 1/16 x 1/2	2	2	-	-	-	
184710	Radiator shutter operating rod yoke end	1	1	-	-	-	
7005	Nut 5/16-24	2	2	-	-	-	

SERVICE PARTS LIST—PACKARD SUPER-EIGHT AND TWELVE

Radiator 185

Piece No.	Name	1500	1506	1603	1607	1707	
		1501	1507	1604	1608	1708	
		1502	1508	1605	No. Required		
5504	Lockwasher 5/16	1	1	-	-	-	
180523	Radiator shutter operating rod yoke end pin	1	1	-	-	-	
4280	Cotter pin 1/16 x 1/2	1	1	-	-	-	
231486	Radiator shutter panel bottom assembly	1	1	-	-	-	
231044	Radiator shutter panel top assembly	1	1	-	-	-	
225134	Radiator shutter spring	1	1	-	-	-	
207518	Radiator shutter thermostat and cover assembly .	1	1	-	-	-	
207536	Radiator shutter thermostat cover gasket	1	1	-	-	-	
5389	Radiator shutter thermostat cover screw No. 10-32 x 7/16 fill. hd.	6	6	-	-	-	
5500	Lockwasher No. 10	6	6	-	-	-	
0239564	Radiator shutter thermostat sylvon assembly (160° to 170°)	1	1	-	-	-	
231471	Radiator shutter tie bar assembly--left	1	1	-	-	-	
231472	Radiator shutter tie bar assembly--right	1	1	-	-	-	
225116	Radiator shutter tie bar center screw fill. hd..	1	1	-	-	-	
225114	Radiator shutter tie bar screw flat hd.	4	4	-	-	-	
225117	Radiator shutter tie bar screw fill. hd.	14	14	-	-	-	
7003	Nut No. 10-32	19	19	-	-	-	
5500	Lockwasher No. 10	19	19	-	-	-	
230219	Radiator shutter top tie bar assembly	1	1	-	-	-	
230378	Radiator shutter top tie bar operating rod bell crank support bracket assembly	1	1	-	-	-	

RADIATOR

240457	Radiator assembly	-	-	1	-	-
240458	Radiator assembly	-	-	-	1	1
240494	Radiator core and brackets assembly	-	-	1	-	-
240364	Radiator core and brackets assembly	-	-	-	1	1
240348	Radiator core cradle	-	-	1	1	1
223265	Radiator core cradle anti-squeak	-	-	1	1	1
7007	Radiator core cradle to radiator core screw nut 7/16-20	-	-	2	2	2
5508	Lockwasher 7/16	-	-	2	2	2
3883	Plain washer 7/16	-	-	2	2	2
223236	Radiator core cradle tie bar	-	-	1	1	1
7608	Bolt 5/16-24 x 3/4 carriage	-	-	4	4	4
7005	Nut 5/16-24	-	-	4	4	4
5504	Lockwasher 5/16	-	-	4	4	4
223242	Radiator core cradle tie bar lock	-	-	1	1	1
240357	Radiator core to shell anti-squeak top	-	-	2	2	2
240274	Radiator core to shell anti-squeak top center ..	-	-	1	1	1
240454	Radiator to dash tie rod--left	-	-	1	2	2
240455	Radiator to dash tie rod--right	-	-	1	-	-
7008	Nut 1/2-20	-	-	6	6	6
6047	Lockwasher 1/2 (Shakeproof)	-	-	4	4	4
3886	Plain washer 1/2 special	-	-	4	4	4
304362	Radiator drain cock	-	-	1	-	-
240528	Radiator drain cock	-	-	-	1	1

Piece No.	Name	1500	1506	1603	1607	1707
		1501	1507	1604	1608	1708
		1502	1508	1605	No. Required	
240405	Radiator drain cock outlet tube assembly	-	-	-	1	1
6475	Nut 5/16 flared tube inverted weatherhead .	-	-	-	1	1
240652	Radiator expansion tank assembly	-	-	-	1	1
7826	Radiator expansion tank assembly to frame screw 5/16-24 x 5/8 hex. hd.	-	-	-	2	2
7005	Nut 5/16-24	-	-	-	2	2
5504	Lockwasher 5/16	-	-	-	2	2
6679	Radiator expansion tank connection lockwasher 11/16 (Shakeproof)	-	-	-	1	1
190680	Radiator expansion tank connection nut 11/16-16 special	-	-	-	1	1
5421	Radiator expansion tank drain plug	-	-	-	1	1
232841	Radiator expansion tank to radiator core tube assembly—front	-	-	-	1	1
240678	Radiator expansion tank to radiator core tube assembly—rear	-	-	-	1	1
162552	Radiator expansion tank to radiator core tube clip style No. 18	-	-	-	1	1
303939	Radiator expansion tank to radiator core tube clip screw 5/16-18 x 1/2 washer—type hex. hd.	-	-	-	1	1
6669	Radiator expansion tank to radiator core tube connector 7/16 flared inverted	-	-	-	1	1
225436	Radiator expansion tank to radiator core tube hose	-	-	-	1	1
205975	Radiator expansion tank to radiator core tube hose clamp	-	-	-	2	2
6670	Radiator expansion tank to radiator core tube (front) union nut 7/16 flared inverted	-	-	-	1	1
6235	Radiator expansion tank to radiator core tube (rear) union nut 7/16 flared	-	-	-	1	1
240464	Radiator fan shroud assembly	-	-	-	1	1
7801	Screw 1/4-28 x 1/2 hex. hd.	-	-	-	6	6
182215	Radiator fan shroud assembly screw No. 10-32 special	-	-	-	2	2
7004	Nut 1/4-28	-	-	-	4	4
7003	Nut No. 10-32	-	-	-	2	2
5502	Lockwasher 1/4	-	-	-	6	6
5500	Lockwasher No. 10	-	-	-	2	2
62065	Plain washer 1/4 special	-	-	-	2	2
6757	Plain washer	-	-	-	2	2
221953	Radiator to frame bolt	-	-	-	1	1
240625	Radiator to frame bolt	-	-	1	-	-
7108	Nut 1/2-20 castle	-	-	1	1	1
221981	Radiator to frame bolt washer	-	-	1	1	1
4291	Cotter pin 3/32 x 3/4	-	-	1	1	1
221978	Radiator to frame bolt spacer—lower	-	-	1	1	1
231438	Radiator to frame bolt spacer—upper	-	-	1	1	1
300593	Radiator filler neck cap assembly	-	-	1	-	-

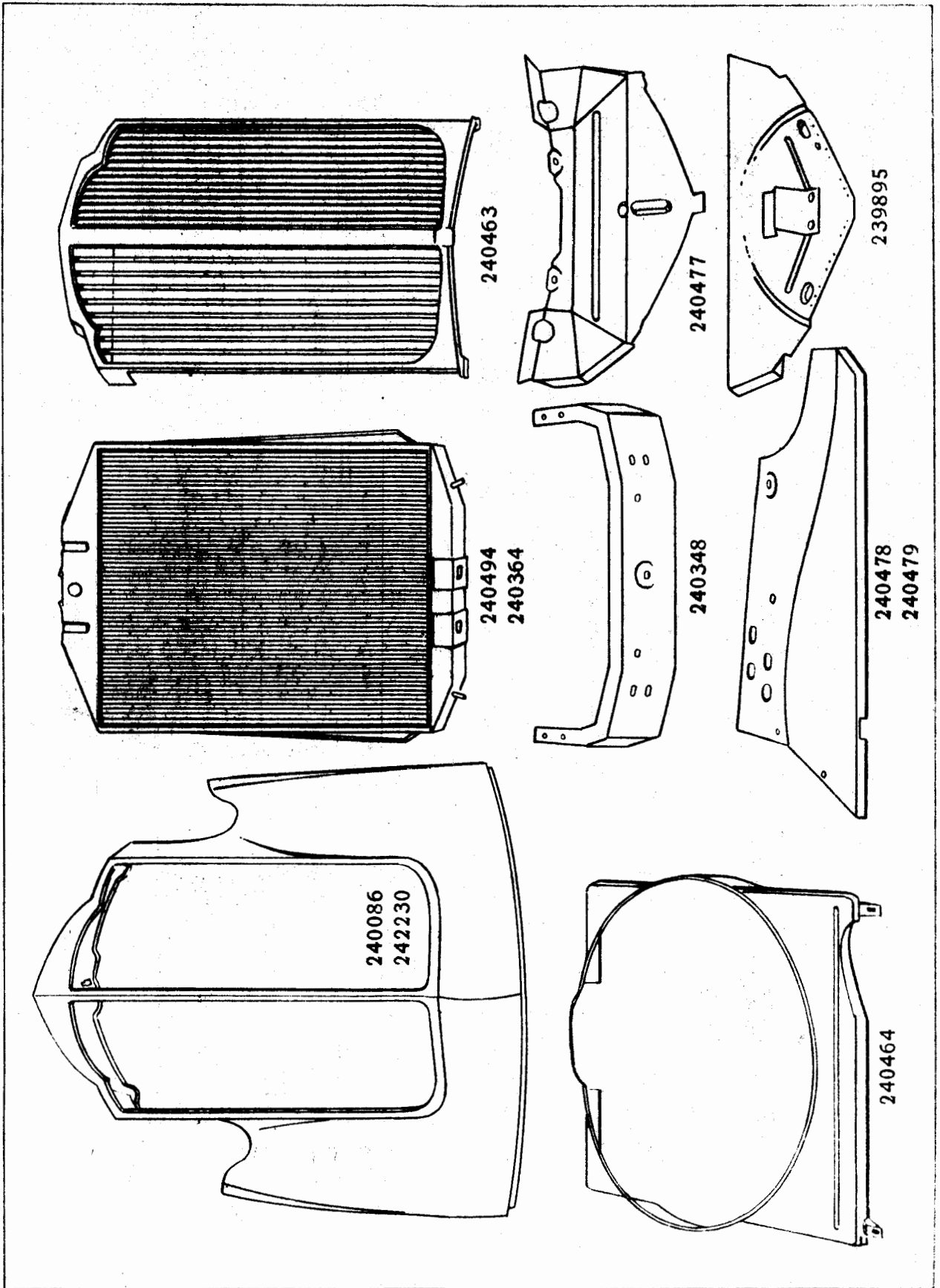

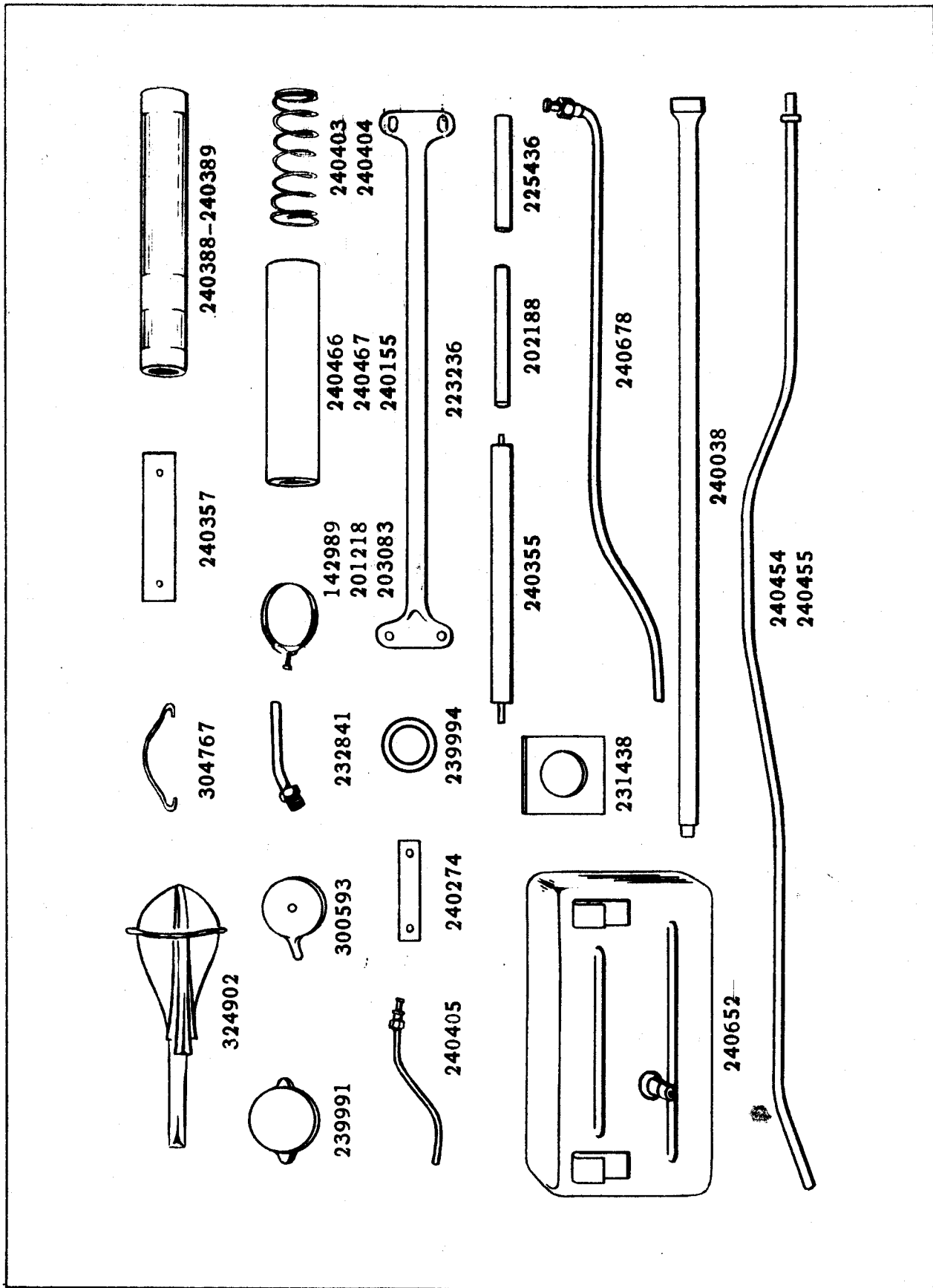



162652



205975

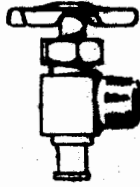

304362



240528



240361



221953
240625



240482



182215

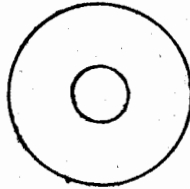

221978

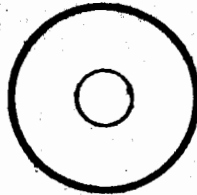

221981



240362



223242

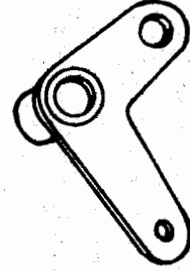

239883-239884



326579



326569



326568

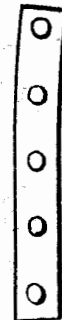

239868

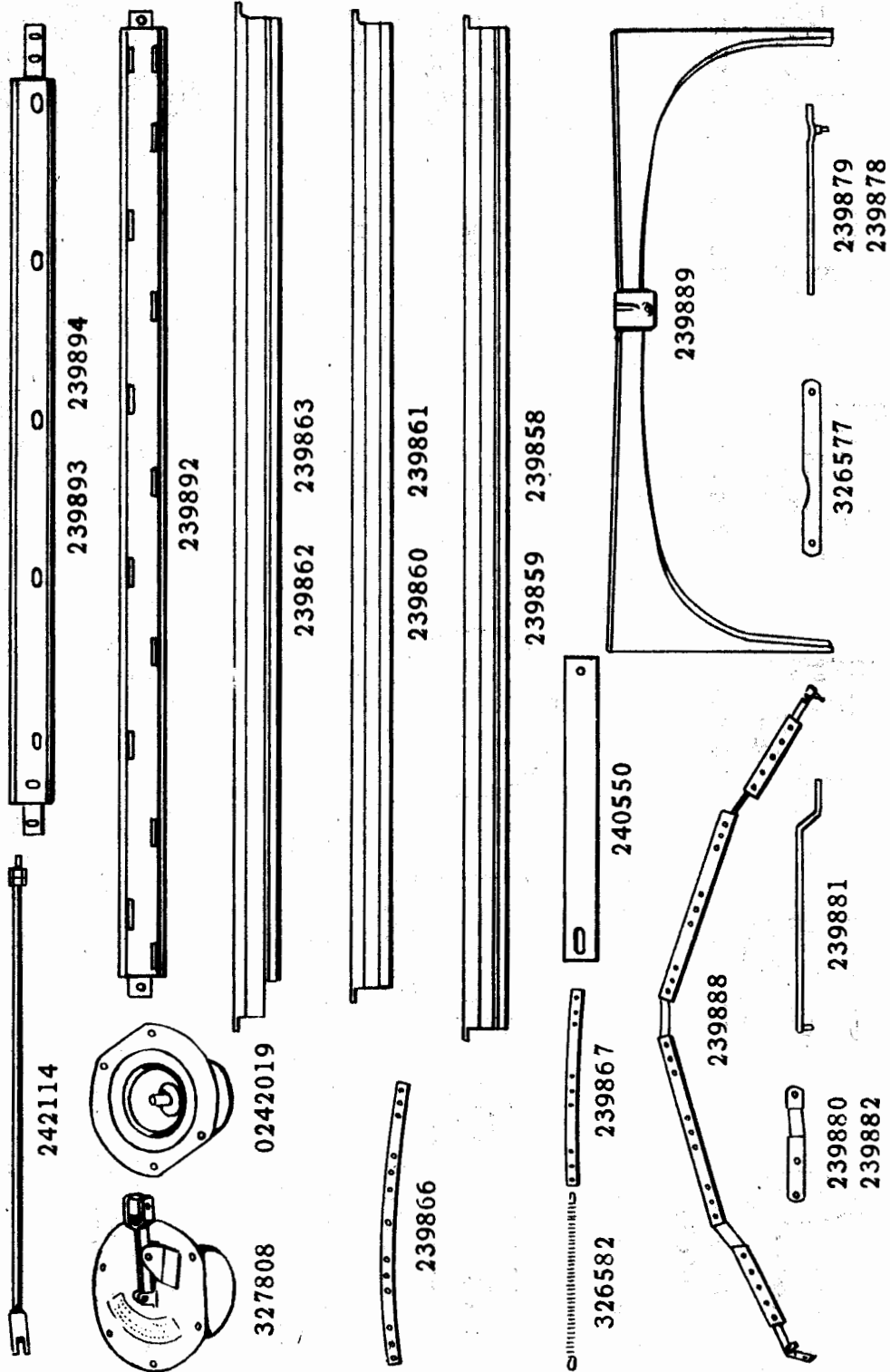

SERVICE PARTS LIST—PACKARD SUPER-EIGHT AND TWELVE

Radiator 191

Piece No.	Name	1500	1506	1603	1607	1707	
		1501	1507	1604	1608	1708	
		1502	1508	1605	No. Required		
239991	Radiator filler neck cap assembly	-	-	-	1	1	
0242554	Radiator filler cap gasket (in cap)	-	-	-	1	1	
239994	Radiator filler neck gasket (in filler neck) ..	-	-	-	1	1	
240466	Radiator hose (inlet)	-	-	1	-	-	
240389	Radiator hose (inlet) long	-	-	-	1	1	
240388	Radiator hose (inlet) short	-	-	-	1	1	
240467	Radiator hose (outlet)	-	-	1	-	-	
240155	Radiator hose (outlet)	-	-	-	1	1	
203083	Radiator hose clamp	-	-	4	-	-	
201218	Radiator hose clamp (large)	-	-	-	2	2	
142989	Radiator hose clamp (small)	-	-	-	4	4	
240403	Radiator hose spring (large)	-	-	-	1	1	
240404	Radiator hose spring (small)	-	-	-	2	2	
202188	Radiator overflow tube hose	-	-	1	-	-	
240086	Radiator shell assembly	-	-	1	1	1	
242230	Radiator shell assembly (Chrome plate)	-	-	1	1	1	
5701	Radiator shell assembly to radiator core screw 1/4-28 x 9/16 flat hd.	-	-	4	4	4	
7824	Screw 1/4-28 x 5/8 hex. hd.	-	-	4	4	4	
7004	Nut 1/4-28	-	-	4	4	4	
5502	Lockwasher 1/4	-	-	8	8	8	
3868	Plain washer	-	-	8	8	8	
240038	Radiator shell center bar	-	-	1	1	1	
240355	Radiator shell lace	-	-	2	2	2	
240356	Radiator shell lace staple	-	-	2	2	2	
239550	Radiator shell ornament assembly	-	-	-	-	1	
324902	Radiator shell ornament and bail assembly	-	-	1	1	-	
304767	Radiator shell ornament bail	-	-	1	1	-	
6631	Set screw No. 12-24 x 3/4 headless	-	-	1	1	-	
240363	Radiator shell ornament retaining lug	-	-	1	1	1	
5696	Screw No. 8-32 x 3/8 fill. hd.	-	-	1	1	1	
5861	Lockwasher No. B (Shakeproof)	-	-	1	1	1	
240361	Radiator shell ornament retaining spring	-	-	3	3	3	
240362	Radiator shell ornament retaining spring plate.	-	-	1	1	1	
4302	Cotter pin 1/8 x 1/2	-	-	1	1	1	
249463	Radiator shutter assembly	-	-	1	1	-	
242398	Radiator shutter assembly	-	-	-	-	1	
240550	Radiator shutter assembly to core strap	-	-	1	1	1	
6185	Screw 5/16-18 x 5/8 hex. hd.	-	-	1	1	1	
7870	Screw 1/4-28 x 5/8 hex. hd.	-	-	1	1	1	
7004	Nut 1/4-28	-	-	1	1	1	
5502	Lockwasher 1/4	-	-	1	1	1	
5504	Lockwasher 5/16	-	-	1	1	1	
3874	Plain washer 5/16	-	-	1	1	1	
7709	Radiator shutter assembly to radiator shell screw No. 10-32 x 7/16 fill. hd.	-	-	10	10	10	
5500	Lockwasher No. 10	-	-	10	10	10	

Piece No.	Name	1500	1506	1603	1607	1707
		1501	1507	1604	1608	1708
		1502	1508	1605	No. Required	
3866	Plain washer No. 10	-	-	10	10	10
239858	Radiator shutter blade assembly--long left	-	-	5	5	2
242392	Radiator shutter blade assembly--long left (Painted) (Specify color)	-	-	-	-	3
239859	Radiator shutter blade assembly--long-right ...	-	-	5	5	2
242393	Radiator shutter blade assembly--long right (Painted) (Specify color)	-	-	-	-	3
239860	Radiator shutter blade assembly--short left ...	-	-	3	3	1
242394	Radiator shutter blade assembly--short left (Painted) (Specify color)	-	-	-	-	2
239861	Radiator shutter blade assembly--short right ..	-	-	3	3	1
242395	Radiator shutter blade assembly--short right (Painted) (Specify color)	-	-	-	-	2
239862	Radiator shutter blade assembly--notched left .	-	-	1	1	1
239863	Radiator shutter blade assembly--notched right.	-	-	1	1	1
239866	Radiator shutter blade bearing assembly--lower.	-	-	2	2	2
239867	Radiator shutter blade bearing assembly--upper long	-	-	2	2	2
239868	Radiator shutter blade bearing assembly--upper short	-	-	2	2	2
239878	Radiator shutter operating bar and stud left assembly	-	-	1	1	1
239879	Radiator shutter operating bar and stud right assembly	-	-	1	1	1
326585	Radiator shutter operating bar and stud assembly cotter pin 1/16 x 5/8	-	-	4	4	4
239880	Radiator shutter operating link--left	-	-	1	1	1
239882	Radiator shutter operating link--right	-	-	1	1	1
326577	Radiator shutter operating link--right center .	-	-	1	1	1
239883	Radiator shutter operating link bell crank and bushing assembly--left	-	-	1	1	1
239884	Radiator shutter operating link bell crank and bushing assembly--right	-	-	1	1	1
326570	Radiator shutter operating link bell crank bushing	-	-	2	2	2
239881	Radiator shutter operating link left and stud assembly	-	-	1	1	1
225111	Radiator shutter operating link screw	-	-	2	2	2
6056	Lockwasher No. 10 (Shakeproof).....	-	-	2	2	2
242114	Radiator shutter operating rod assembly	-	-	1	1	1
326569	Radiator shutter operating rod bell crank pin .	-	-	2	2	2
7005	Radiator shutter operating rod nut 5/16-24	-	-	2	2	2
5504	Lockwasher 5/16	-	-	1	1	1
326568	Radiator shutter operating rod yoke end pin ...	-	-	1	1	1

SERVICE PARTS LIST—PACKARD SUPER-EIGHT AND TWELVE

Radiator 193

Piece No.	Name	1500	1506	1603	1607	1707
		1501	1507	1604	1608	1708
		1502	1508	1605	No. Required	
326579	Radiator shutter operating rod yoke end pin lock	-	-	1	1	1
239888	Radiator shutter panel top	-	-	1	1	1
326582	Radiator shutter spring	-	-	1	1	1
239889	Radiator shutter tie bar bottom assembly	-	-	1	1	1
239892	Radiator shutter tie bar center	-	-	1	1	1
239893	Radiator shutter tie bar—left	-	-	1	1	1
239894	Radiator shutter tie bar—right	-	-	1	1	1
225117	Radiator shutter tie bar screw No. 10-32 x 3/8 fill. hd.	-	-	10	10	5
7003	Nut No. 10-32	-	-	10	10	5
5500	Lockwasher No. 10	-	-	10	10	5
6528	Radiator shutter top tie bar to panel top rivet 3/16 x 3/16 rnd. hd. tubular	-	-	-	-	5
239895	Radiator shutter top tie bar assembly	-	-	1	1	1
327808	Radiator shutter thermostat and cover assembly (Supersedes 324399)	-	-	1	1	1
324226	Radiator shutter thermostat cover gasket	-	-	1	1	1
5389	Radiator shutter thermostat cover screw No. No. 10-32 x 7/16 fill. hd.	-	-	6	6	6
5500	Lockwasher No. 10	-	-	6	6	6
0242019	Radiator shutter thermostat syphon (150° to 165°)	-	-	1	1	1
0327796	Radiator shutter thermostat syphon (135° to 150°)	-	-	1	1	1
240477	Radiator splasher—lower	-	-	1	1	1
6603	Radiator splasher lower to radiator core cradle screw 1/4-28 x 3/8 hex. hd.	-	-	4	4	4
5502	Lockwasher 1/4	-	-	4	4	4
7709	Radiator splasher lower to radiator shutter screw No. 10-32 x 7/16 fill. hd.	-	-	8	8	8
7003	Nut No. 10-32	-	-	8	8	8
5500	Lockwasher No. 10	-	-	8	8	8
3866	Plain washer No. 10	-	-	8	8	8
7709	Radiator splasher lower to side splasher screw No. 10-32 x 7/16 fill. hd.	-	-	2	2	2
7003	Nut No. 10-32	-	-	2	2	2
5500	Lockwasher No. 10	-	-	2	2	2
3866	Plain washer No. 10	-	-	4	4	4
240478	Radiator splasher side assembly—left	-	-	1	1	1
240479	Radiator splasher side assembly—right	-	-	1	1	1
6588	Radiator splasher side assembly to radiator core screw 1/4-28 x 1/2 rnd. hd.	-	-	2	2	2
5502	Lockwasher 1/4	-	-	2	2	2
62065	Plain washer 1/4 special	-	-	2	2	2
7709	Radiator splasher side assembly to radiator shutter screw No. 10-32 x 7/16 fill. hd.	-	-	2	2	2
5500	Lockwasher No. 10	-	-	2	2	2
3866	Plain washer No. 10	-	-	2	2	2
240482	Radiator splasher side rubber bumper	-	-	2	2	2

Piece No.	Name	1500	1506	1603	1607	1707	
		1501	1507	1604	1608	1708	
		1502	1508	1605	No. Required		
REAR AXLE							
234735	Rear axle case assembly	1	-	1	-	-	
231154	Rear axle case assembly	-	1	-	1	1	
197093	Rear axle case cover	1	-	1	-	-	
196708	Rear axle case cover	-	1	-	1	1	
201508	Rear axle case cover stud--long	2	-	2	-	-	
7106	Nut 3/8-24 castle	2	-	2	-	-	
3877	Washer 3/8 plain	2	-	2	-	-	
4290	Cotter pin 3/32 x 5/8.	2	-	2	-	-	
5997	Rear axle case cover stud-short 3/8-24 x 1-3/16	8	-	8	-	-	
7006	Nut (short) 3/8-24	8	-	8	-	-	
5506	Lockwasher 3/8	8	-	8	-	-	
5999	Stud 7/16-20 x 1-1/4	-	8	-	8	8	
7007	Nut 7/16-20	-	8	-	8	8	
5508	Lockwasher 7/16	-	8	-	8	8	
197094	Rear axle case cover gasket	1	-	1	-	-	
201259	Rear axle case cover gasket	-	1	-	1	1	
232960	Rear axle case ventilator assembly	1	1	1	1	1	
197095	Rear axle differential bearing adjusting nut ..	2	-	2	-	-	
138121	Rear axle differential bearing adjusting nut ..	-	2	-	2	2	
6025	Cotter pin 3/16 x 7/8	2	-	2	-	-	
4332	Cotter pin 3/16 x 1-1/4	-	2	-	2	2	
140067	Rear axle differential bearing adjusting nut lock	-	2	-	2	2	
0202843	Rear axle differential bearing assembly	2	-	2	-	-	
0180750	Rear axle differential bearing assembly	-	2	-	2	2	
223840	Rear axle differential carrier assembly (4.69 to 1 ratio) (Standard)	1	-	1	-	-	
223842	Rear axle differential carrier assembly (4.36 to 1 ratio) (Special)	1	-	1	-	-	
237660	Rear axle differential carrier assembly (4.9 to 1 ratio) (Special)	1	-	1	-	-	
219524	Rear axle differential carrier assembly (4.41 to 1 ratio) (Standard)	-	1	-	1	1	
219525	Rear axle differential carrier assembly (4.69 to 1 ratio) (Special)	-	1	-	1	1	
219526	Rear axle differential carrier assembly (4.06 to 1 ratio) (Special)	-	1	-	1	1	
231330	Rear axle differential carrier and caps assy. .	1	-	1	-	-	
231331	Rear axle differential carrier and caps assy. .	-	1	-	1	1	
197101	Rear axle differential carrier cap	2	-	2	-	-	
196709	Rear axle differential carrier cap	-	2	-	2	2	
196850	Rear axle differential carrier cap stud	4	-	4	-	-	
196849	Rear axle differential carrier cap stud	-	4	-	4	4	
7107	Nut 7/16-20 castle	4	-	4	-	-	
7108	Nut 1/2-20 castle	-	4	-	4	4	
4291	Cotter pin 3/32 x 3/4	4	4	4	4	4	
196801	Rear axle differential carrier cap stud washer.	4	-	4	-	-	
196807	Washer	-	4	4	-	-	
5690	Rear axle differential carrier cap stud gasket 7/16 annular	4	-	4	-	-	

SERVICE PARTS LIST--PACKARD SUPER-EIGHT AND TWELVE

Rear Axle 195

Piece No.	Name	1500	1506	1603	1607	1707	
		1501	1507	1604	1608	1708	
		1502	1508	1605	No. Required		
45933	Gasket 1/2 annular	-	4	-	4	4	
197102	Rear axle differential carrier cap spacer nut .	4	-	4	-	-	
196808	Rear axle differential carrier cap spacer nut .	-	4	-	4	4	
210201	Rear axle differential carrier to case gasket .	1	-	1	-	-	
201260	Rear axle differential carrier to case gasket .	-	1	-	1	1	
6012	Rear axle differential carrier to case stud-- short 3/8-24 x 1-13/32	5	-	5	-	-	
6331	Stud--long 3/8-24 x 1-27/32	3	-	3	-	-	
7006	Nut 3/8-24	8	-	8	-	-	
5506	Lockwasher 3/8	8	-	8	-	-	
201253	Rear axle differential carrier to case stud-- long	-	2	-	2	2	
7107	Nut 7/16-20 castle	-	2	-	2	2	
3912	Washer 7/16	-	2	-	2	2	
4291	Cotter pin 3/32 x 3/4	-	2	-	2	2	
5998	Stud--short 7/16-20 x 1-9/16	-	8	-	8	8	
7007	Nut 7/16-20	-	8	-	8	8	
5508	Lockwasher 7/16	-	8	-	8	8	
6343	Rear axle differential carrier dowel pin (3/8 x 13/16)	2	2	2	2	2	
6099	Rear axle differential carrier oil plug 1/2 sq. hd.	2	-	2	-	-	
107889	Rear axle differential carrier oil plug	-	2	-	2	2	
20075	Rear axle differential carrier oil plug gasket.	-	2	-	2	2	
197106	Rear axle differential case assembly	1	-	1	-	-	
242206	Rear axle differential case assembly (Supersedes 239032)	-	1	-	1	1	
197107	Rear axle differential case stud	8	-	8	-	-	
196741	Rear axle differential case stud	-	8	-	8	8	
7106	Nut 3/8-24 castle	8	8	8	8	8	
120813	Rear axle differential case stud nut lockwire 7" long	4	4	4	4	4	
202370	Rear axle differential driving gear and pinion assembly (4.69 to 1 ratio) (61-13 teeth)	1	-	1	-	-	
202369	Rear axle differential driving gear and pinion assembly (4.36 to 1 ratio) (61-14 teeth)	1	-	1	-	-	
141903	Rear axle differential driving gear and pinion assembly (4.41 to 1 ratio) (75-17 teeth)	-	1	-	1	1	
141460	Rear axle differential driving gear and pinion assembly (4.69 to 1 ratio) (75-16 teeth)	-	1	-	1	1	
141459	Rear axle differential driving gear and pinion assembly (4.06 to 1 ratio) (69-17 teeth)	-	1	-	1	1	
239031	Rear axle differential driving gear and pinion assembly (4.9 to 1 ratio) (59-12 teeth)	1	-	1	-	-	
194182	Rear axle differential driving gear screw	12	16	12	16	16	
120813	Rear axle differential driving gear screw lock-wire 7" long	6	8	6	8	8	
197114	Rear axle differential driving pinion adjusting shim--thin	x	-	x	-	-	
196739	Rear axle differential driving pinion adjusting shim--thin	-	x	-	x	x	

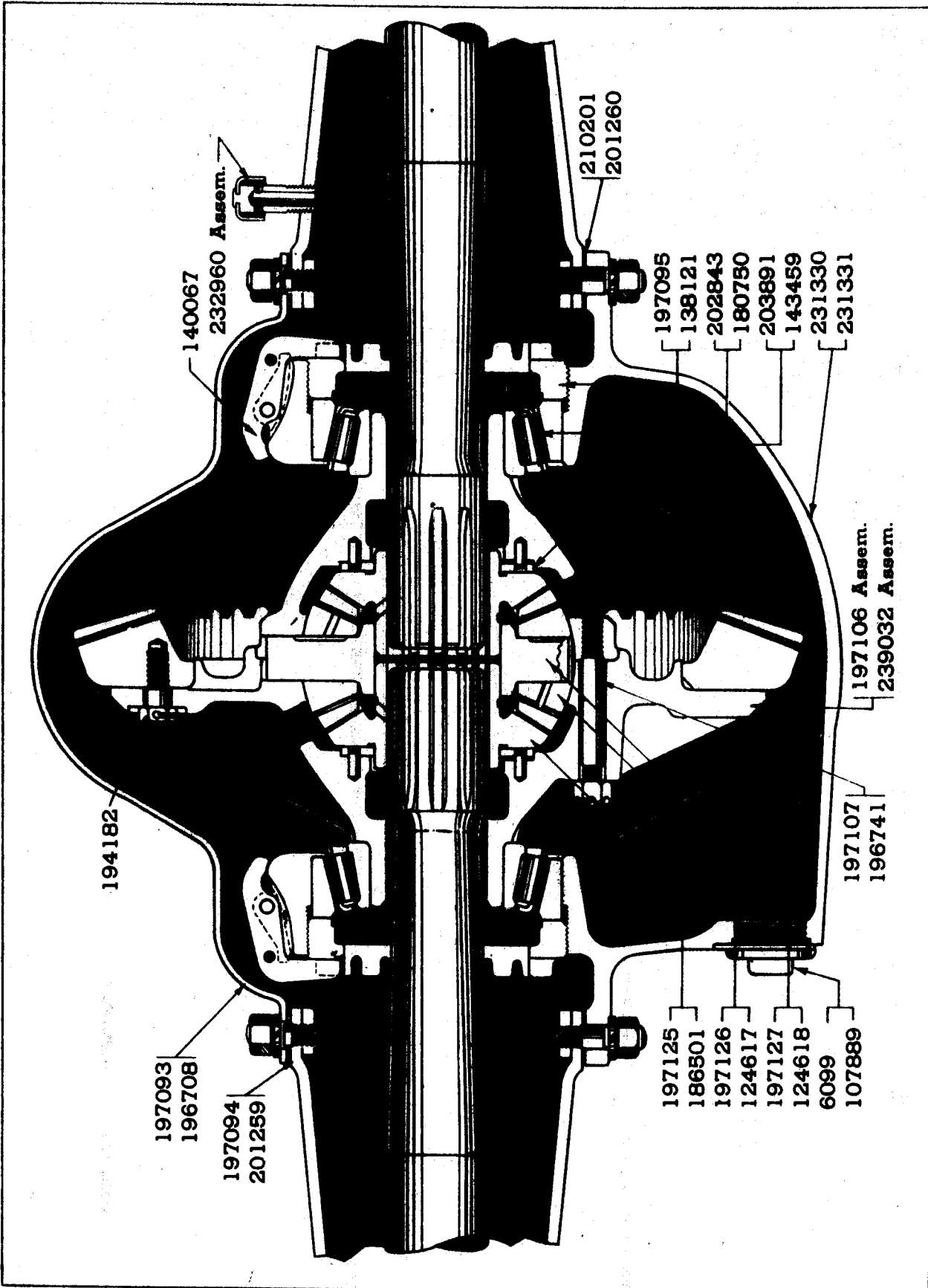

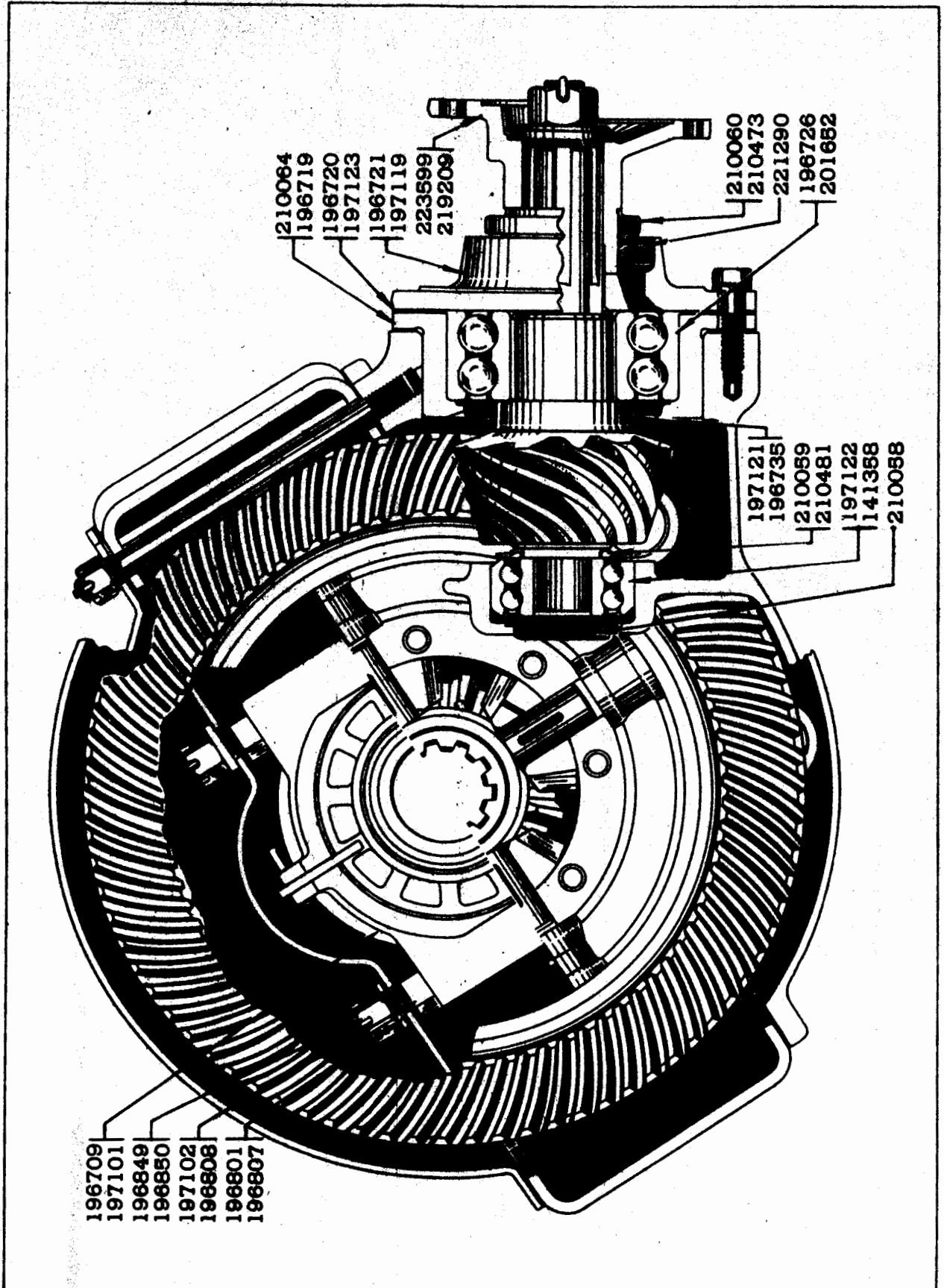

Piece No.	Name	1500	1506	1603	1607	1707	
		1501	1507	1604	1608	1708	
		1502	1508	1605	No. Required		
197115	Rear axle differential driving pinion adjusting shim--thick	x	-	x	-	-	
196738	Rear axle differential driving pinion adjusting shim--thick	-	x	-	x	x	
196740	Rear axle differential driving pinion adjusting shim--medium	-	x	-	x	x	
201652	Rear axle differential driving pinion bearing-- front	1	-	1	-	-	
196726	Rear axle differential driving pinion bearing-- front	-	1	-	1	1	
197116	Rear axle differential driving pinion bearing front dust shield	1	1	1	1	1	
197123	Rear axle differential driving pinion bearing front gasket	1	-	1	-	-	
196720	Rear axle differential driving pinion bearing front gasket	-	1	-	1	1	
210060	Rear axle differential driving pinion bearing front oil filter assembly	1	-	1	-	-	
210473	Rear axle differential driving pinion bearing front oil filter assembly	-	1	-	1	1	
221290	Rear axle differential driving pinion bearing front oil seal	1	1	1	1	1	
197119	Rear axle differential driving pinion bearing front retainer	1	-	1	-	-	
196721	Rear axle differential driving pinion bearing front retainer	-	1	-	1	1	
7824	Screw 1/4-28 x 5/8 hex. hd.	2	-	2	-	-	
6011	Screw 1/4-28 x 11/16 hex. hd.	-	2	-	2	2	
5502	Lockwasher 1/4	2	2	2	2	2	
210064	Rear axle differential driving pinion bearing front sleeve	1	-	1	-	-	
196719	Rear axle differential driving pinion bearing front sleeve	-	1	-	1	1	
7820	Screw 3/8-24 x 1-3/8 hex. hd.	7	-	7	-	-	
7822	Screw 3/8-24 x 1-1/2 hex. hd.	-	8	-	8	8	
5506	Lockwasher 3/8	7	8	7	8	8	
197121	Rear axle differential driving pinion bearing front spacer	1	-	1	-	-	
196735	Rear axle differential driving pinion bearing front spacer	-	1	-	1	1	
197122	Rear axle differential driving pinion bearing-- rear	1	-	1	-	-	
141358	Rear axle differential driving pinion bearing-- rear	-	1	-	1	1	
210058	Rear axle differential driving pinion bearing rear oil filter assembly	1	1	1	1	1	
210059	Rear axle differential driving pinion bearing rear oil thrower	1	-	1	-	-	
210481	Rear axle differential driving pinion bearing rear oil thrower	-	1	-	1	1	
223599	Rear axle differential driving pinion universal joint flange	1	-	1	-	-	

SERVICE PARTS LIST--PACKARD SUPER-EIGHT AND TWELVE

Rear Axle 199

Piece No.	Name	1500	1506	1603	1607	1707
		1501	1507	1604	1608	1708
		1502	1508	1605	No. Required	
219209	Rear axle differential driving pinion universal joint flange	-	1	-	1	1
127273	Nut	1	1	1	1	1
4320	Cotter pin 5/32 x 1-1/8	1	1	1	1	1
140079	Rear axle differential driving pinion universal joint flange washer	1	1	1	1	1
197125	Rear axle differential gear	2	-	2	-	-
186501	Rear axle differential gear	-	2	-	2	2
203891	Rear axle differential gear thrust washer	2	-	2	-	-
143459	Rear axle differential gear thrust washer	-	2	-	2	2
4724	Dowel pin 3/16 x 1/2	-	4	-	4	4
197126	Rear axle differential pinion	4	-	4	-	-
124617	Rear axle differential pinion	-	4	-	4	4
197127	Rear axle differential pinion spider	1	-	1	-	-
124618	Rear axle differential pinion spider	-	1	-	1	1
207085	Rear axle differential pinion thrust washer ...	4	-	4	-	-
242207	Rear axle differential pinion thrust washer (bronze)	-	-	-	4	4
221717	Rear axle shaft--left	1	-	1	-	-
231153	Rear axle shaft--left	-	1	-	1	1
221716	Rear axle shaft--right	1	-	1	-	-
231152	Rear axle shaft--right	-	1	-	1	1
0176592	Rear axle shaft bearing assembly	4	-	4	-	-
0205684	Rear axle shaft bearing assembly	-	4	-	4	4
231160	Rear axle shaft bearing oil guard	-	2	-	2	2
234655	Rear axle shaft bearing oil guard	2	-	2	-	-
309522	Rear axle shaft bearing oil seal--inner (Supersedes 170290)	2	-	2	-	-
196742	Rear axle shaft bearing oil seal--inner	-	2	-	2	2
210140	Rear axle shaft bearing oil seal--outer	2	-	2	-	-
232676	Rear axle shaft bearing oil seal--outer	-	2	-	2	2
231158	Rear axle shaft bearing oil seal retainer	-	2	-	2	2
234654	Rear axle shaft bearing oil seal retainer	2	-	2	-	-
231159	Gasket	-	6	-	6	6
234656	Gasket	6	-	6	-	-
196743	Rear axle shaft bearing shim .005	-	x	-	x	x
207428	Rear axle shaft bearing shim .005	x	-	x	-	-
203736	Rear axle shaft bearing shim .016	-	x	-	x	x
207430	Rear axle shaft bearing shim .016	x	-	x	-	-
203734	Rear axle shaft bearing shim .003	-	x	-	x	x
207427	Rear axle shaft bearing shim .003	x	-	x	-	-
203735	Rear axle shaft bearing shim .008	-	x	-	x	x
197130	Rear axle shaft key	2	-	2	-	-
231310	Rear axle shaft key	-	2	-	2	2
215185	Rear axle shaft nut	2	-	2	-	-
124631	Rear axle shaft nut	-	2	-	2	2
6024	Cotter pin	2	-	2	-	-
4334	Cotter pin 3/16 x 1-3/4	-	2	-	2	2
126985	Washer	2	-	2	-	-
3896	Washer 1" plain	-	2	-	2	2
237750	Rear axle stabilizer bracket	-	2	-	2	2

Piece No.	Name	1500	1506	1603	1607	1707	
		1501	1507	1604	1608	1708	
		1502	1508	1605	No. Required		
RUNNING BOARD							
0239513	Running board left assembly--complete (Use on 1500)	1	-	-	-	-	
0239514	Running board left assembly--complete (Use on 1501)	1	-	-	-	-	
0239515	Running board left assembly--complete (Use on 1502)	1	-	-	-	-	
0239516	Running board left assembly--complete (Use on 1506)	-	1	-	-	-	
0239517	Running board left assembly--complete (Use on 1507)	-	1	-	-	-	
0239518	Running board left assembly--complete (Use on 1508)	-	1	-	-	-	
0239519	Running board right assembly--complete (Use on 1500)	1	-	-	-	-	
0239520	Running board right assembly--complete (Use on 1501)	1	-	-	-	-	
0239521	Running board right assembly--complete (Use on 1502)	1	-	-	-	-	
0239522	Running board right assembly--complete (Use on 1506)	-	1	-	-	-	
0239523	Running board right assembly--complete (Use on 1507)	-	1	-	-	-	
0239524	Running board right assembly--complete (Use on 1508)	-	1	-	-	-	
223904	Running board to body liner (Specify color) (Use on 1500 and 1506)	2	2	-	-	-	
223905	Running board to body liner (Specify color) (Use on 1501 and 1507)	2	2	-	-	-	
223906	Running board to body liner (Specify color) (Use on 1502 and 1508)	2	2	-	-	-	
21964	Rivet 9/64 x 5/16 flat head tubular	x	x	-	-	-	
139521	Running board to body liner to fender rivet 5/32 x 7/16 oval head split	4	2	-	-	-	
223822	Running board bracket front assembly	2	2	-	-	-	
5449	Running board bracket front to frame bolt 5/16-24 x 3/4 hex. head (Use with bodies 1027-1039-1073)	-	2	-	-	-	
6044	Lockwasher 5/16 (Use with bodies 1027- 1039-1073)	-	2	-	-	-	
7005	Nut 5/16-24 plain (Use with bodies 1027- 1039-1073)	-	2	-	-	-	
209524	Running board bracket--center	2	2	-	-	-	
209525	Running board bracket--rear	2	2	-	-	-	
4175	Rivet 5/16 x 7/8 round head	20	22	-	-	-	
4176	Rivet 5/16 x 1 round head	2	-	-	-	-	

SERVICE PARTS LIST--PACKARD SUPER-EIGHT AND TWELVE

Running Board 201

Piece No.	Name	1500	1506	1603	1607	1707	
		1501	1507	1604	1608	1708	
		1502	1508	1605	No. Required		
7600	Running board to bracket bolt 5/16-24 x 7/8 carriage	12	12	-	-	-	
5504	Lockwasher 5/16	12	12	-	-	-	
3874	Washer 5/16 plain	12	12	-	-	-	
7005	Nut 5/16-24	12	12	-	-	-	
216915	Running board to bracket liner	6	6	-	-	-	
223638	Running board mat assembly--right (Use on 1500)	1	-	-	-	-	
223634	Running board mat assembly--right (1501)	1	-	-	-	-	
223632	Running board mat assembly--right (Use on 1502 and 1507)	1	1	-	-	-	
223636	Running board mat assembly--right (Use on 1506)	-	1	-	-	-	
223630	Running board mat assembly--right (Use on 1508)	-	1	-	-	-	
223639	Running board mat assembly--left (Use on 1500)	1	-	-	-	-	
223635	Running board mat assembly--left (Use on 1501)	1	-	-	-	-	
223633	Running board mat assembly--left (Use on 1502 and 1507)	1	1	-	-	-	
223637	Running board mat assembly--left (Use on 1506)	-	1	-	-	-	
223631	Running board mat assembly--left (Use on 1508)	-	1	-	-	-	
228731	Running board moulding (inboard) (Use on 1500)	2	-	-	-	-	
228733	Running board moulding (inboard) (Use on 1501)	2	-	-	-	-	
228734	Running board moulding (inboard) (Use on 1502 and 1507)	2	2	-	-	-	
228732	Running board moulding (inboard) (Use on 1506)	-	2	-	-	-	
228735	Running board moulding (inboard) (Use on 1508)	-	2	-	-	-	
232545	Running board moulding--front right	1	1	-	-	-	
232544	Running board moulding--front left	1	1	-	-	-	
232546	Running board moulding--rear right	1	1	-	-	-	
232547	Running board moulding--rear left	1	1	-	-	-	
237028	Running board moulding (outboard)--right (Use on 1500)	1	-	-	-	-	
237027	Running board moulding (outboard)--left (Use on 1500)	1	-	-	-	-	
237030	Running board moulding (outboard)--right (Use on 1501)	1	-	-	-	-	
237029	Running board moulding (outboard)--left (Use on 1501)	1	-	-	-	-	
237032	Running board moulding (outboard)--right (Use on 1502 and 1507)	1	1	-	-	-	
237031	Running board moulding (outboard)--left (Use on 1502 and 1507)	1	1	-	-	-	
237034	Running board moulding (outboard)--right (Use on 1506)	-	1	-	-	-	
237033	Running board moulding (outboard)--left (Use on 1506)	-	1	-	-	-	
237036	Running board moulding (outboard)--right (Use on 1508)	-	1	-	-	-	
237035	Running board moulding (outboard)--left (Use on 1508)	-	1	-	-	-	
5840	Running board moulding screw No. 10-24 x 13/32 fill. head (Used with front and rear mouldgs.	24	24	-	-	-	
183962	Running board moulding cup washer (Used with front and rear mouldings)	24	24	-	-	-	

Piece No.	Name	1500	1506	1603	1607	1707
		1501	1507	1604	1608	1708
		1502	1508	1605	No. Required	
5935	Lockwasher No. 10 (Shakeproof) (Used with front and rear mouldings)	24	24	-	-	-
225681	Running board moulding screw	30	30	-	-	-
6587	Lockwasher 3/16 (Shakeproof)	30	30	-	-	-
7003	Nut No. 10-32	30	30	-	-	-

RUNNING BOARD

240146	Running board assembly--left (Use on 1603)	-	-	1	-	-
240147	Running board assembly--right (Use on 1603) ...	-	-	1	-	-
240148	Running board assembly--left (Use on 1604-1607-1707)	-	-	1	1	1
240149	Running board assembly--right (Use on 1604-1607-1707)	-	-	1	1	1
240150	Running board assembly--left (Use on 1605-1608-1708)	-	-	1	1	1
240151	Running board assembly--right (Use on 1605-1608-1708)	-	-	1	1	1
7600	Running board assembly to frame bracket bolt 5/16-24 x 7/8 carriage	-	-	12	12	12
7005	Nut 5/16-24	-	-	12	12	12
5504	Lockwasher 5/16	-	-	12	12	12
3874	Plain washer 5/16	-	-	12	12	12
216915	Running board assembly to frame bracket liner .	-	-	6	6	6
7870	Running board assembly to splasher screw 1/4-28 x 5/8 hex. head	-	-	16	16	16
7004	Nut 1/4-28	-	-	16	16	16
5502	Lockwasher 1/4	-	-	16	16	16
3868	Plain washer 1/4	-	-	16	16	16
240335	Running board bracket center	-	-	2	2	2
240130	Running board bracket front assembly	-	-	2	2	2
7809	Running board bracket front assembly to frame bolt 5/16-24 x 7/8 hex. head	-	-	-	2	2
7005	Nut 5/16-24	-	-	-	2	2
6044	Lockwasher 5/16 (Shakeproof)	-	-	-	2	2
240336	Running board bracket--rear	-	-	2	2	2
4175	Running board bracket rivet 5/16 x 7/8 round hd.	-	-	20	19	19
4176	Rivet 5/16 x 1 round head	-	-	2	-	-
4177	Rivet 5/16 x 1-1/8 round head	-	-	-	2	2
240379	Running board moulding (Use on 1603)	-	-	2	-	-
240380	Running board moulding (Use on 1604-1607-1707)	-	-	2	2	2
240381	Running board moulding (Use on 1605-1608-1708)	-	-	2	2	2
307040	Running board moulding clip (Gagnier Type)	-	-	26	26	26
307041	Running board moulding clip (Cinch Type)	-	-	4	4	4
240337	Running board and splasher assembly to body liner (Use on 1603)	-	-	2	-	-
240338	Running board and splasher assembly to body liner (Use on 1604-1607-1707)	-	-	2	2	2

SERVICE PARTS LIST--SUPER EIGHT AND TWELVE

Shock Absorber 203

Piece No.	Name	1500	1506	1603	1607	1707
		1501	1507	1604	1608	1708
		1502	1508	1605	No. Required	
240339	Running board and splasher assembly to body liner (Use on 1605-1608-1708)	-	-	2	2	2
21964	Running board and splasher assembly to body liner rivet No. 632--9/64 x 5/16 flat head tubular	-	-	26	26	26
240371	Running board splasher assembly--left (Use on 1603)	-	-	1	-	-
240372	Running board splasher assembly--right (Use on 1603)	-	-	1	-	-
240373	Running board splasher assembly--left (Use on 1604-1607-1707)	-	-	1	1	1
240374	Running board splasher assembly--right (Use on 1604-1607-1707)	-	-	1	1	1
240375	Running board splasher assembly--left (Use on 1605-1608-1708)	-	-	1	1	1
240376	Running board splasher assembly--right (Use on 1605-1608-1708)	-	-	1	1	1

SHOCK ABSORBER

303808	Shock absorber (front) assembly--right (Use with bodies 1012-1013-1016-L394)	1	-	-	-	-
237079	Shock absorber (front) assembly--right (Use with bodies 1027-1032-1033-1036-1038-1039-L394)	-	1	-	-	-
317521	Shock absorber (front) assembly--right (Use with bodies 1003-1014-1015-1063-L395)	1	-	-	-	-
317513	Shock absorber (front) assembly--right (Use with bodies 1007-1018-1019)	1	-	-	-	-
317616	Shock absorber (front) assembly--right (Use with body 1017)	1	-	-	-	-
237552	Shock absorber (front) assembly--left (Use with bodies 1023-1034-1035-1037-73-L395)	-	1	-	-	-
237551	Shock absorber (front) assembly--right (Use with bodies 1023-1034-1035-1037-73-L395)	-	1	-	-	-
303807	Shock absorber (front) assembly--left (Use with bodies 1012-1013-1016-L394)	-	1	-	-	-
237078	Shock absorber (front) assembly--left (Use with bodies 1027-1032-1033-1036-1038-1039-L394) ..	-	1	-	-	-
317520	Shock absorber (front) assembly--left (Use with bodies 1003-1014-1015-1063-L395)	1	-	-	-	-
317512	Shock absorber (front) assembly--left (Use with bodies 1007-1018-1019)	1	-	-	-	-
317615	Shock absorber (front) assembly--left (Use with body 1017)	1	-	-	-	-
303808	Shock absorber assembly--front right (Export) (Use with bodies 1018-1019)	1	-	-	-	-
303807	Shock absorber assembly--front left (Export) (Use with bodies 1018-1019)	1	-	-	-	-
239091	Shock absorber assembly--front right (Export) (Use with bodies 1023-1037-1038-1039)	-	1	-	-	-

Piece No.	Name	1500	1506	1603	1607	1707
		1501	1507	1604	1608	1708
		1502	1508	1605	No. Required	
239090	Shock absorber assembly--front right (Export) (Use with bodies 1023-1037-1038-1039)	-	1	-	-	-
239224	Shock absorber assembly--front right (Export) (Use with bodies 1032-1033-1034-1035-1073- L395)	-	1	-	-	-
239223	Shock absorber assembly--front left (Export) (Use with bodies 1032-1033-1034-1035-1073- L395)	-	1	-	-	-
303661	Shock absorber assembly--front right (Export) (Use with bodies 1003-1033-1012-1013-1014- 1015-1016-1063)	1	-	-	-	-
303660	Shock absorber assembly--front left (Export) (Use with bodies 1003-1012-1013-1014-1015- 1016-1063)	1	-	-	-	-
317521	Shock absorber assembly--front right (Export) (Use with body 1007)	1	-	-	-	-
317520	Shock absorber assembly--front left (Export) (Use with body 1007)	1	-	-	-	-
302564	Shock absorber (front) assembly screw 1/2-20 x 1-7/8 hex. head	2	-	-	-	-
223966	Shock absorber (front) assembly screw 1/2-20 x 5-1/4 hex. head	-	8	-	-	-
311705	Shock absorber (front) assembly screw 1/2-20 x 1-7/8 hex. head	2	-	-	-	-
6042	Shock absorber (front) assembly screw 1/2-20 x 3 hex. head	4	-	-	-	-
6047	Lockwasher 1/2	8	8	-	-	-
316934	Shock absorber (front) assembly bolt plain washer	4	-	-	-	-
303943	Shim	x	x	-	-	-
232700	Shock absorber assembly--rear left (Use with bodies 1003-1007-1014-1015-1017-1018-1019- 1063-L395 and hearse chassis)	1	-	-	-	-
234525	Shock absorber assembly--rear left (Use with bodies 1027-1032-1033-1038-1039-L394)	-	1	-	-	-
237554	Shock absorber assembly--rear left (Use with bodies 1023-1034-1035-1037-1073-L395) (Supersedes 237500)	-	1	-	-	-
239260	Shock absorber assembly--rear left (Use with body 1036)	-	1	-	-	-
237992	Shock absorber assembly--rear left (Use with bodies 1012-1013-1016-L394)	1	-	-	-	-
232701	Shock absorber assembly--rear right (Use with bodies 1003-1007-1014-1015-1017-1018-1019- 1063-L395 and hearse chassis)	1	-	-	-	-
234524	Shock absorber assembly--rear right (Use with bodies 1027-1032-1033-1038-1039-L394)	-	1	-	-	-
237553	Shock absorber assembly--rear right (Use with bodies 1034-1035-1023-1037-1073-L395) (Supersedes 237499)	-	1	-	-	-
239261	Shock absorber assembly--rear right (Use with body 1036)	-	1	-	-	-

SERVICE PARTS LIST--PACKARD SUPER-EIGHT AND TWELVE

Shock Absorber 205

Piece No.	Name	1500	1506	1603	1607	1707	
		1501	1507	1604	1608	1708	
		1502	1508	1605	No. Required		
237993	Shock absorber assembly--rear right (Use with bodies 1011-1013-1016-L394)	1	-	-	-	-	
237553	Shock absorber assembly--rear right (Export) (Use with bodies 1038-1039)	-	1	-	-	-	
237554	Shock absorber assembly--rear left (Export) (Use with bodies 1038-1039)	-	1	-	-	-	
237993	Shock absorber assembly--rear right (Export) (Use with body 1007)	1	-	-	-	-	
237992	Shock absorber assembly--rear left (Export) (Use with body 1007)	1	-	-	-	-	
239079	Shock absorber assembly--rear right (Export) (Use with bodies 1003-1012-1013-1014-1015-1016-1018-1019-1063)	1	-	-	-	-	
239078	Shock absorber assembly--rear left (Export) (Use with bodies 1003-1012-1013-1014-1015-1016-1018-1019-1063)	1	-	-	-	-	
239092	Shock absorber assembly--rear right (Export) (Use with body 1023)	-	1	-	-	-	
239093	Shock absorber assembly--rear left (Export) (Use with body 1023)	-	1	-	-	-	
239312	Shock absorber assembly--rear right (Export) (Use with body 1037)	-	1	-	-	-	
239311	Shock absorber assembly--rear left (Export) (Use with body 1037)	-	1	-	-	-	
239415	Shock absorber assembly--rear right (Export) (Use with bodies 1032-1033)	-	1	-	-	-	
239414	Shock absorber assembly--rear left (Export) (Use with bodies 1032-1033)	-	1	-	-	-	
232144	Shock absorber--rear to frame bolt 9/16-18 x 4-5/8 hex. head	4	-	-	-	-	
234522	Shock absorber--rear to frame screw	-	4	-	-	-	
7009	Nut 9/16-18	4	4	-	-	-	
6674	Lockwasher 9/16 (Shakeproof)	4	4	-	-	-	
237005	Shock absorber--rear link assembly	2	2	-	-	-	
237006	Shock absorber--rear link stud nut 1/2-20 thread self-locking type	2	2	-	-	-	
221725	Shock absorber--rear link grommet	4	4	-	-	-	
221721	Shock absorber--rear link grommet retainer	4	4	-	-	-	
216371	Shock absorber--rear link grommet retainer nut 7/16-20	2	2	-	-	-	
4291	Cotter pin 3/32 x 3/4	2	2	-	-	-	

SHOCK ABSORBER

240693	Shock absorber (front) assembly--right (Use with bodies 1112-1113-1116-1117-1118-1119) ..	-	-	1	-	-
242245	Shock absorber (front) assembly--left (Use with body 1103)	-	-	1	-	-
242246	Shock absorber (front) assembly--right (Use with body 1103)	-	-	1	-	-

NOTE: SEE SERVICE BULLETINS FOR SHOCK ABSORBER EXCHANGES.

Piece No.	Name	1500	1506	1603	1607	1707	
		1501	1507	1604	1608	1708	
		1502	1508	1605	No. Required		
242044	Shock absorber (front) assembly--left (Use with bodies 1132-33-34-35-36-53-1232-33-34-35-36-53)	-	-	-	1	1	
242041	Shock absorber (front) assembly--left (Use with bodies 1137-38-39-1227-37-38-39)	-	-	-	1	1	
242043	Shock absorber (front) assembly--right (Use with bodies 1132-33-35-36-53-1232-33-34-35-36-53)	-	-	-	1	1	
242040	Shock absorber (front) assembly--right (Use with bodies 1137-38-39-1227-37-38-39)	-	-	-	1	1	
240692	Shock absorber (front) assembly--left (Use with bodies 1112-13-16-17-18-19)	-	-	1	-	-	
242148	Shock absorber (front) assembly--left (Use with body 1107)	-	-	1	-	-	
242149	Shock absorber (front) assembly--right (Use with body 1107)	-	-	1	-	-	
242133	Shock absorber (front) assembly--left (Use with bodies 1114-1115-1144-1145-1143)	-	-	1	-	-	
242134	Shock absorber (front) assembly--right (Use with bodies 1114-1115-1144-1145-1143)	-	-	1	-	-	
6765	Screw 1/4-20 x 2-1/8 hex. head	-	-	2	-	-	
324486	Shock absorber (front) assembly screw 1/2-20 x 2-1/8 hex. head	-	-	2	-	-	
6042	Screw 1/2-20 x 3 hex. head	-	-	4	-	-	
223966	Shock absorber (front) assembly screw 1/2-20 x 5-1/4 hex. head	-	-	-	8	8	
6047	Lockwasher 1/2 (Shakeproof)	-	-	8	8	8	
316934	Shock absorber (front) assembly screw plain washer	-	-	4	-	-	
303943	Shock absorber (front) assembly screw shim	-	-	x	x	x	
240703	Shock absorber assembly--rear left (Use with bodies 1103-07-12-13-16-17-18-19)	-	-	1	-	-	
242132	Shock absorber assembly--rear right (Use with bodies 1114-15-44-45-43)	-	-	1	-	-	
242038	Shock absorber assembly--rear left (Use with bodies 1127-32-33-34-35-36-37-38-39-53-1227-32-33-34-35-36-37-38-39-53)	-	-	-	1	1	
240704	Shock absorber assembly--rear right (Use with bodies 1103-07-12-13-16-17-18-19)	-	-	1	-	-	
242131	Shock absorber assembly--rear left (Use with bodies 1114-15-44-45-43)	-	-	1	-	-	
242039	Shock absorber assembly--rear right (Use with bodies 1127-32-33-34-35-36-37-38-39-53-1227-32-33-34-35-36-37-38-39-53)	-	-	-	1	1	
232144	Shock absorber rear to frame bolt 9/16 18 x 4-5/8 hex. head	-	-	4	-	-	
234522	Shock absorber rear to frame screw	-	-	-	4	4	
7009	Nut 9/16-18	-	-	4	4	4	

SERVICE PARTS LIST--PACKARD SUPER-EIGHT AND TWELVE

Shock Absorber 207

Piece No.	Name	1500	1506	1603	1607	1707
		1501	1507	1604	1608	1708
		1502	1508	1605	No. Required	
6674	Lockwasher 9/16 internal (Shakeproof)	-	-	4	4	4
237005	Shock absorber--rear link assembly	-	-	2	2	2
237006	Shock absorber--rear link stud nut 1/2-20 thread--self-locking type	-	-	2	2	2
221725	Shock absorber--rear link grommet	-	-	4	4	4
221721	Shock absorber--rear link grommet retainer	-	-	4	4	4
216371	Shock absorber--rear link grommet retainer nut 7/16-20	-	-	2	2	2
4291	Cotter pin 3/32 x 3/4	-	-	2	2	2

SHOCK ABSORBER VALVES
(1500-1-2-6-7-8)

FRONT SHOCK ABSORBER

REAR SHOCK ABSORBER

FRONT SHOCK ABSORBER						REAR SHOCK ABSORBER					
Shock Abs. No.		Rebound Valve		Compr. Valve		Shock Abs. No.		Rebound Valve		Compr. Valve	
Right	Left	Sym.	Pc. No.	Sym.	Pc. No.	Right	Left	Sym.	Pc. No.	Sym.	Pc. No.
317521	317520	3-F	0317946	2-C	0303918	232701	232700	1-F	0304542	E-2	0304813
317513	317512	2-B	0317859	2-B	0317859	237992	237992	5-F	0317947	G-0	0317948
303808	303807	2-F	0303915	2-C	0303918	237553	237554	1-N	0239030	E-1	0231028
317616	317615	2-B	0317859	2-C	0303918	234524	234525	1-N	0239030	E-3	0225673
237551	237552	3-C	0239080	C3-W	0239029
237079	237078	4-C	0239027	A3-W	0239028
303661	303660	2-F	0303915	2-D	0303917	239261	239260	1-H	0213164	C-2	0239330
239091	239090	3-C	0239080	E-2	0304813	239079	239078	1-F	0304542	G-0	0317948
239224	239223	4-C	0239027	A-3	0239494	239092	239093	2-N	0239498	C3-W	0239029
.....	239415	239414	1-J	0239507	C-3	0239495
.....	239312	239311	3-C	0239080	E-3	0225673

SHOCK ABSORBER VALVES
(1603-4-5-7-8, 1707-8)

FRONT SHOCK ABSORBER

REAR SHOCK ABSORBER

FRONT SHOCK ABSORBER						REAR SHOCK ABSORBER					
Shock Abs. No.		Rebound Valve		Compr. Valve		Shock Abs. No.		Rebound Valve		Compr. Valve	
Right	Left	Sym.	Pc. No.	Sym.	Pc. No.	Right	Left	Sym.	Pc. No.	Sym.	Pc. No.
240693	240692	2-E-1	0327872	3-D-1	0327875	240704	240703	5-J	0230399	E-O-2	0327877
242043	242044	3-E	0242234	C-1-W	0242231	242131	242132	5-P-4	0327879	E-O-2	0327877
242040	242041	C-3	0239495	C-4	0242233	242039	242038	1-J	0239507	E-1-W	0242232
242149	242148	3-C-3	0327873	4-D-1	0327876
242134	242133	3-E-5	0327874	3-D-1	0327875
242246	242245	2-C-5	0242327	6-D-1	0242328

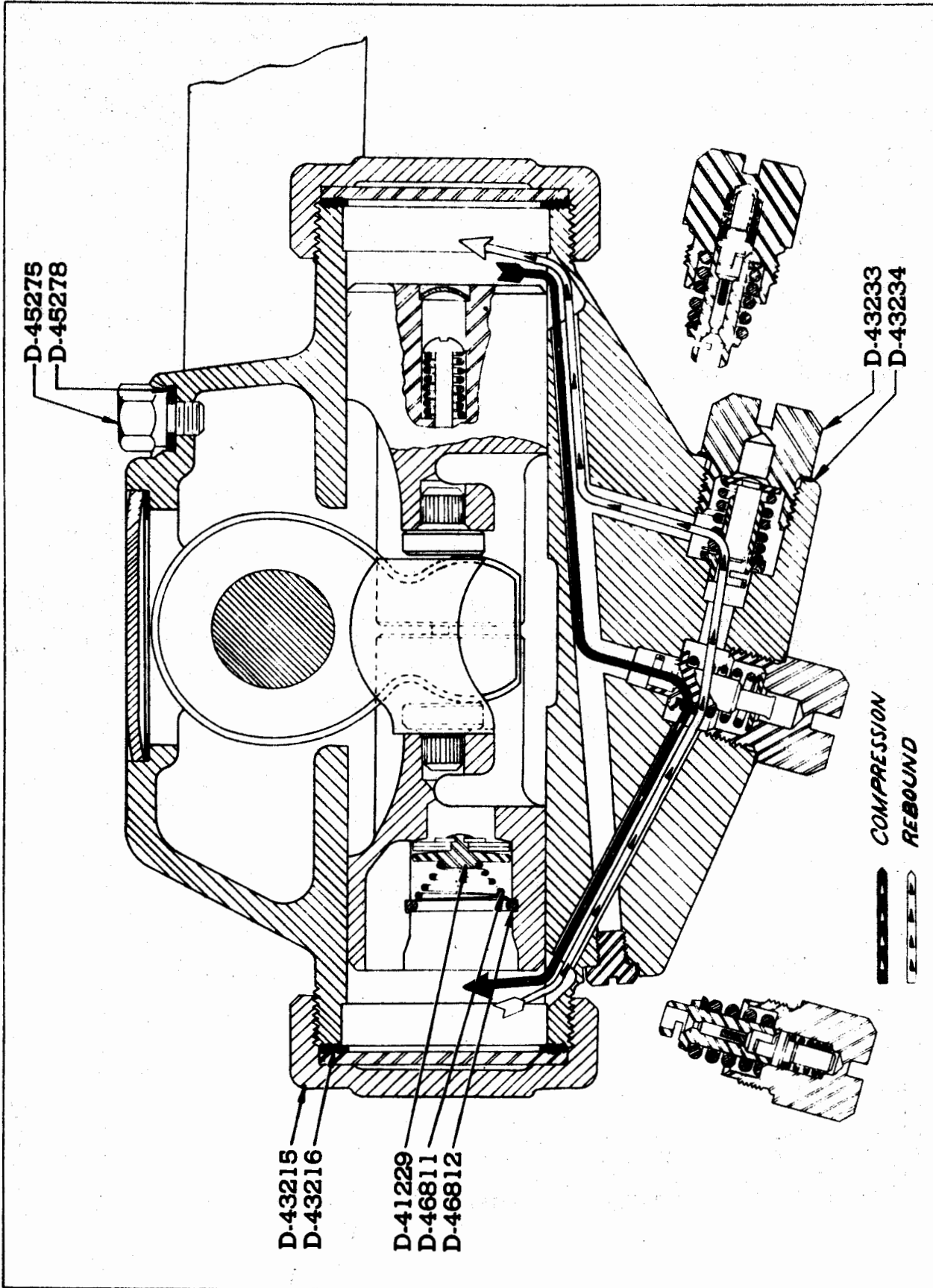

SERVICE PARTS LIST--PACKARD SUPER-EIGHT AND TWELVE

Splasher 209

Piece No.	Name	1500	1506	1603	1607	1707	
		1501	1507	1604	1608	1708	
		1502	1508	1605	No. Required		
SPLASHERS							
232511	Splasher--frame to crankcase--left	1	-	-	-	-	
240289	Splasher--frame to crankcase--left	-	-	1	-	-	
234748	Splasher--frame to crankcase--right assembly (L.H. drive)	1	-	-	-	-	
240308	Splasher--frame to crankcase--right assembly (L.H. drive)	-	-	1	-	-	
237120	Splasher--frame to crankcase--left assembly ...	-	1	-	-	-	
240299	Splasher--frame to crankcase--left assembly ...	-	-	-	1	-	
237121	Splasher--frame to crankcase--right assembly ..	-	1	-	-	-	
240300	Splasher--frame to crankcase--right assembly ..	-	-	-	1	1	
237317	Splasher--frame to crankcase--front left assembly (R.H. drive)	1	-	1	-	-	
237318	Splasher--frame to crankcase--front right assembly (R.H. drive)	1	-	1	-	-	
237314	Splasher--frame to crankcase--right (R.H. drive)	1	-	-	-	-	
240307	Splasher--frame to crankcase--right (R.H. drive)	-	-	1	-	-	
232780	Splasher--frame to crankcase front	-	1	-	-	-	
6359	Splasher--frame to crankcase spacer	-	8	-	8	8	
232791	Splasher--frame to crankcase screw 5/16-18 x 5/8 hex. hd. (Shakeproof) washer type	6	8	6	8	8	
234529	Splasher--frame to crankcase front--left assembly (L.H. drive)	1	-	1	-	-	
234530	Splasher--frame to crankcase front--right assembly (L.H. drive)	1	-	1	-	-	
308352	Splasher--frame to crankcase front left screw No. 6 x 1/4 Parker Kalon	3	-	3	-	-	
3866	Washer 3/16	3	-	3	-	-	
232502	Splasher--frame to crankcase brace--left	1	-	-	-	-	
240623	Splasher--frame to crankcase brace--left	-	-	1	-	-	
232503	Splasher--frame to crankcase brace--right	1	-	-	-	-	
240624	Splasher--frame to crankcase brace--right	-	-	1	-	-	
232778	Splasher--frame to crankcase brace--left	-	1	-	1	1	
232779	Splasher--frame to crankcase brace--right	-	1	-	1	1	
304078	Splasher--frame to crankcase brace to frame screw 3/8-16 x 1/2 hex. head (Shakeproof) washer type	2	2	2	2	2	
7801	Splasher--frame to crankcase brace to splasher screw 1/4-28 x 1/2 hex. head	2	2	2	2	2	
3868	Washer 1/4 plain	2	2	2	2	2	
5502	Lockwasher 1/4	2	2	2	2	2	
7004	Nut 1/4-28	2	2	2	2	2	
232791	Splasher--frame to crankcase front to frame screw 5/16-18 x 5/8 hex. head (Shakeproof) washer type	2	2	2	2	2	
7801	Splasher--frame to crankcase front to side splasher screw 1/4-28 x 1/2 hex. head	-	4	-	2	2	
3868	Washer 1/4 plain	-	4	-	2	2	
5502	Lockwasher 1/4	-	4	-	2	2	
7004	Nut 1/4-28	-	4	-	2	2	

SPRING (REAR) CHART

Spring Assembly	Load and Rate	Canvas	Spring Covers			Bushing Rear
			Upper	Lower Front	Lower Rear	
237640	1400# x 145	232462	232460	232461	232476	231181
237643	1500# x 145	232462	232460	232461	232476	231181
237642	1400# x 150	232750	232747	232748	232749	231182
237645	1500# x 150	232750	232747	232748	232749	231182
237641	1300# x 145	232462	232460	232461	232476	231181
237644	1300# x 150	232750	232747	232748	232749	231182
237925	1500# x 165	237931	237933	237921	237922	231181
237926	1400# x 165	237931	237933	237921	237922	231181
237927	1600# x 165	237931	237933	237921	237922	231181
237929	1500# x 165	237932	232747	237923	237924	231182
237930	1400# x 165	237932	232747	237923	237924	231182
239147	1600# x 185	237932	239222	239220	239221	231182
239367	1500# x 155	237931	237933	239405	239406	231181
239472	1500# x 175	237932	232747	239477	239478	231182
242033	1400# x 135	232462	242128	242124	242125	231181
242017	1300# x 120	232462	242128	242120	242121	231181
242037	1500# x 135	242130	242128	242122	242123	231181
242018	1300# x 120	232750	242129	242126	242127	231182

Piece No.	Name	1500	1506	1603	1607	1707
		1501	1507	1604	1608	1708
		1502	1508	1605		
					No. Required	

SPRING (REAR)

NOTE: See spring chart for spring covers and canvas.

237640	Spring (rear) cover and bushings assembly (1400 lbs. x 145 rate) (Use with bodies 1003-07-12-13-16-63)	2	-	-	-	-
237641	Spring (rear) cover and bushings assembly (1300 lbs. x 145 rate) (Use with bodies 1017-1018-1019)	2	-	-	-	-
237642	Spring (rear) cover and bushings assembly (1400 lbs. x 150 rate) (Use with bodies 1023-27-32-33-36-73-1127-32-33-36-53-1227-32-33-36-43)	-	2	-	2	2
237643	Spring (rear) cover and bushings assembly (1500 lbs. x 145 rate) (Use with bodies 1014-1015-L394-L395)	2	-	-	-	-
237644	Spring (rear) cover and bushings assembly (1300 lbs. x 150 rate) (Use with bodies 1037-1038-1039)	-	2	-	-	-
237645	Spring (rear) cover and bushings assembly (1500 lbs. x 150 rate) (Use with bodies 1034-35-L394-L395-1134-1135-1234-35)	-	2	-	2	2

SERVICE PARTS LIST--PACKARD SUPER-EIGHT AND TWELVE

Spring (Rear) 211

Piece No.	Name	1500	1506	1603	1607	1707	
		1501	1507	1604	1608	1708	
		1502	1508	1605	No. Required		
237653	Spring (rear) cover and bushing assembly (1700 lbs. x 165 rate) (Use with Hearse Chassis) ..	2	-	-	-	-	
242033	Spring (rear) cover and bushing assembly (1400 lbs. x 135 rate) (Use with bodies 1103-1107-1112-1113-1116-1143)	-	-	2	-	-	
242017	Spring (rear) cover and bushing assembly (1300 lbs. x 120 rate) (Use with bodies 1117-1118-1119)	-	-	2	-	-	
242037	Spring (rear) cover and bushing assembly (1500 lbs. x 135 rate) (Use with bodies 1114-1115) ..	-	-	2	-	-	
242018	Spring (rear) cover and bushing assembly (1300 lbs. x 120 rate) (Use with bodies 1137-1138-1139-1237-38-39)	-	-	-	2	2	
237642	Spring (rear) cover and bushing assembly (Export) (1400 lbs. x 150 rate) (Use with body 1037)	-	2	-	-	-	
239472	Spring (rear) cover and bushing assembly (Export) (1500 lbs. x 175 rate) (Use with body 1033)	-	2	-	-	-	
239367	Spring (rear) cover and bushing assembly (Export) (1500 lbs. x 155 rate) (Use with body 1007)	2	-	-	-	-	
237925	Spring (rear) cover and bushing assembly (Export) (1500 lbs. x 165 rate) (Use with bodies 1003-1012-1013-1016-1063)	2	-	-	-	-	
237926	Spring (rear) cover and bushings assembly (Export) (1400 lbs. x 165 rate) (Use with bodies 1017-1018-1019)	2	-	-	-	-	
237927	Spring (rear) cover and bushings assembly (Export) (1600 lbs. x 165 rate) (Use with bodies 1014-1015)	2	-	-	-	-	
237929	Spring (rear) cover and bushings assembly (Export) (1500 lbs. x 165 rate) (Use with bodies 1023-1027-1032-1036)	-	2	-	-	-	
237930	Spring (rear) cover and bushings assembly (Export) (1400 lbs. x 165 rate) (Use with bodies 1038-1039)	-	2	-	-	-	
239147	Spring (rear) cover and bushings assembly (Export) (1600 lbs. x 185 rate) (Use with bodies 1034-1035-L395) (Supersedes 237928) ..	-	2	-	-	-	
232044	Spring (rear) block--left	1	-	1	-	-	
232390	Spring (rear) block--left	-	1	-	1	1	
237911	Spring (rear) block--right (Use with bodies 1007-1019-1063)	1	-	-	-	-	
232045	Spring (rear) block--right (Use with bodies 1003-1012-1013-1014-1015-1016-1017-1018)	1	-	-	-	-	
237912	Spring (rear) block--right	-	1	-	-	-	
239899	Spring (rear) block--right	-	-	1	-	-	
239900	Spring (rear) block--right	-	-	-	1	1	
232742	Spring (rear) bolt--front	-	2	-	2	2	
232517	Spring (rear) bolt--front	2	-	2	-	-	
232518	Spring (rear) bolt--front washer	2	2	2	2	2	

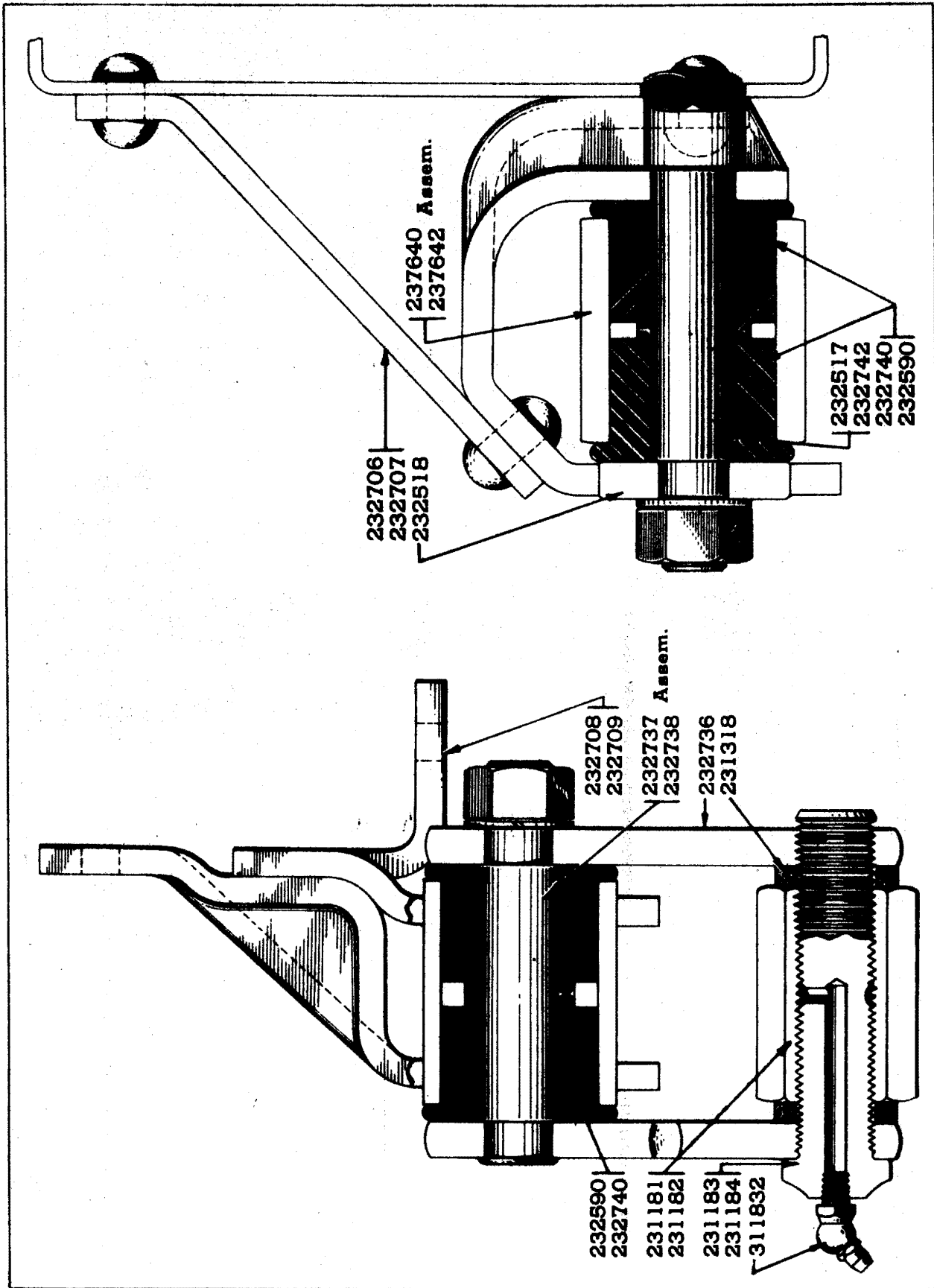

Models 1500-1-2-6-7-8

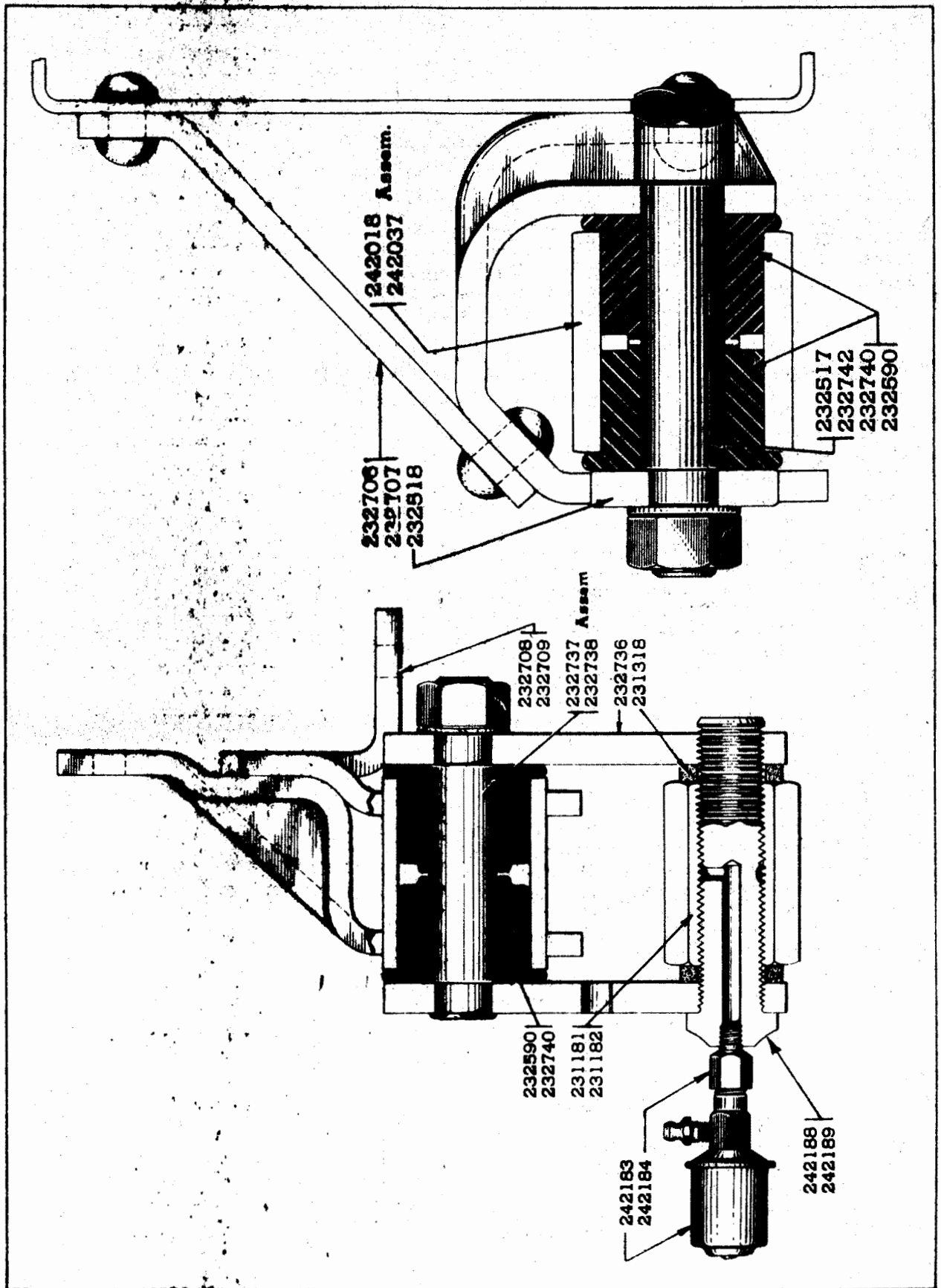

Piece No.	Name	1500	1506	1603	1607	1707
		1501	1507	1604	1608	1708
		1502	1508	1605	No. Required	
6439	Lockwasher 5/8 heavy duty (Shakeproof) ...	2	2	2	2	2
7010	Nut 5/8-18	2	2	2	2	2
232590	Spring (rear) bushing--front	4	-	4	-	-
232740	Spring (rear) bushing--front	-	4	-	4	4
0239057	Spring (rear) center bolt and nut	-	2	-	2	2
0242236	Spring (rear) center bolt and nut	2	-	2	-	-
237834	Spring (rear) clip (Use with Export springs) ..	4	-	-	-	-
203427	Spring (rear) clip (Use with bodies 1103-1107- 1112-1113-1116-1117-1118-1119-1143)	-	-	4	-	-
237834	Spring (rear) clip (Use with bodies 1114-1115- 1144-1145)	-	-	4	-	-
179157	Spring (rear) clip	-	-	-	4	4
138551	Spring (rear) clip (Use with export spring for 1707-8)	-	4	-	-	-
139515	Spring (rear) clip nut	8	-	8	-	-
62455	Spring (rear) clip nut	-	8	-	8	8
6047	Lockwasher 1/2 heavy duty (Shakeproof) ...	8	-	8	-	-
6439	Lockwasher 5/8 heavy duty (Shakeproof) ...	-	8	-	8	8
0237549	Spring (rear) main leaf	2	-	2	-	-
0239056	Spring (rear) main leaf	-	2	-	2	2
186242	Spring (rear) rubber bumper	2	2	-	-	-
326953	Spring (rear) rubber bumper	-	-	2	2	2
186243	Spring (rear) rubber bumper bracket	2	2	2	2	2
7822	Screw 3/8-24 x 1-1/2 hex. hd.	4	4	4	4	4
5506	Lockwasher 3/8	4	4	4	4	4
232736	Spring (rear) shackle inner	2	2	2	2	2
232737	Spring (rear) shackle (outer) assembly	2	-	2	-	-
232738	Spring (rear) shackle (outer) assembly	-	2	-	2	2
231183	Spring (rear) shackle bolt	2	-	-	-	-
231184	Spring (rear) shackle bolt	-	2	-	-	-
242188	Spring (rear) shackle bolt	-	-	2	-	-
242189	Spring (rear) shackle bolt	-	-	-	2	2
232590	Spring (rear) shackle bushing (frame bracket) .	4	-	4	-	-
232740	Spring (rear) shackle bushing (frame bracket) .	-	4	-	4	4
231181	Spring (rear) shackle bolt bushing (spring eye)	2	-	2	-	-
231182	Spring (rear) shackle bolt bushing (spring eye)	-	2	-	2	2
231318	Spring (rear) shackle bolt gasket	4	4	4	4	4
311832	Spring (rear) shackle bolt oiler	2	2	-	-	-
242183	Spring (rear) shackle bolt oiler	-	-	2	2	2
242184	Spring (rear) shackle bolt oiler adapter	-	-	2	2	2
6439	Spring (rear) shackle stud lockwasher 5/8 heavy duty	2	2	2	2	2
7010	Nut 5/8-18 plain	2	2	2	2	2

STABILIZER

0239303	Stabilizer front equipment	1	-	-	-	-
234561	Stabilizer front assembly	1	-	1	-	-
237452	Stabilizer front assembly	-	1	-	-	-
239781	Stabilizer front assembly	-	-	-	1	1
234560	Stabilizer front to frame bracket	2	2	2	2	2

SERVICE PARTS LIST--PACKARD SUPER-EIGHT AND TWELVE

Stabilizer 215

Piece No.	Name	1500	1506	1603	1607	1707	
		1501	1507	1604	1608	1708	
		1502	1508	1605	No. Required		
7952	Stabilizer front to frame bolt 7/16-20 x 7/8 hex. hd.	4	4	4	4	4	
6045	Lockwasher 7/16 (Shakeproof)	4	4	4	4	4	
7007	Nut 7/16-20	4	4	4	4	4	
7008	Stabilizer front to jack bracket nut 1/2-20 ...	4	2	4	2	2	
6047	Lockwasher 1/2 (Shakeproof)	2	2	2	2	2	
0341072	Stabilizer front link assembly	2	2	2	-	-	
0341078	Stabilizer front link assembly--right	-	-	-	1	1	
0341079	Stabilizer front link assembly--left	-	-	-	1	1	
0341073	Stabilizer front link adjusting plug	4	4	4	4	4	
0341074	Stabilizer front link cushion	8	8	8	8	8	
0341075	Stabilizer front link cushion retainer	4	4	4	4	4	
0341080	Stabilizer front link stud	-	2	-	2	2	
0341076	Stabilizer front link stud	2	-	2	-	-	
0341077	Stabilizer front rod	1	1	1	-	-	
0341081	Stabilizer front rod	-	-	-	1	1	
0341082	Stabilizer front rod bearing	2	2	2	2	2	
237941	Stabilizer lateral bracket brace (Use with bodies 1007-19-63-23-27-32-33-34-35-36-37-38-39-73-L394-L395)	1	1	1	1	1	
158003	Stabilizer lateral bracket brace nut 3/8 plain (Use with bodies 1007-19-63-23-27-32-33-34-35-36-37-38-39-73-L394-L395)	4	4	4	4	4	
6361	Stabilizer lateral bracket brace lockwasher 3/4 (Shakeproof) (Use with bodies 1007-19-63-23-27-32-33-34-35-36-37-38-39-73-L394-L395)	4	4	4	4	4	
237945	Stabilizer lateral bracket left and reinforcement assembly (Use with bodies 1007-19-63-23-27-32-33-34-35-36-37-38-39-73-L394-L395)	1	1	-	-	-	
239850	Stabilizer lateral bracket left and reinforcement assembly	-	-	1	1	1	
6039	Stabilizer lateral bracket left and reinforcement assembly to frame screw 5/16-24 x 11/16 hex. hd. (Use with bodies 1007-19-63-23-27-32-33-34-35-36-37-38-39-73-L394-L395)	4	4	4	4	4	
7952	Stabilizer lateral bracket left and reinforcement assembly to frame screw 7/16-20 x 7/8 hex. hd. (Use with bodies 1007-19-63-L394-L395)	1	-	1	-	-	
6044	Lockwasher (Shakeproof) (Use with bodies 1007-19-63-23-27-32-33-34-35-36-37-38-39-73-L394-L395)	4	4	4	4	4	
6045	Lockwasher (Shakeproof) (Use with bodies 1007-19-63-L394-L395)	1	-	1	-	-	
237759	Stabilizer lateral tube and bushing assembly (Use with bodies 1007-19-63-23-27-32-33-34-35-36-37-38-39-73-L394-L395)	1	1	-	-	-	
237756	Stabilizer lateral tube bushing (Use with bodies 1007-19-63-23-27-32-33-34-35-36-37-38-39-73-L394-L395)	2	2	-	-	-	
239844	Stabilizer lateral tube bushing	-	-	2	2	2	
237244	Stabilizer lateral tube bushing bolt 1/2 x 3-1/2 hex. hd. (Use with bodies 1007-19-63-23-27-32-33-34-35-36-37-38-39-73-L394-L395) ..	2	2	-	-	-	

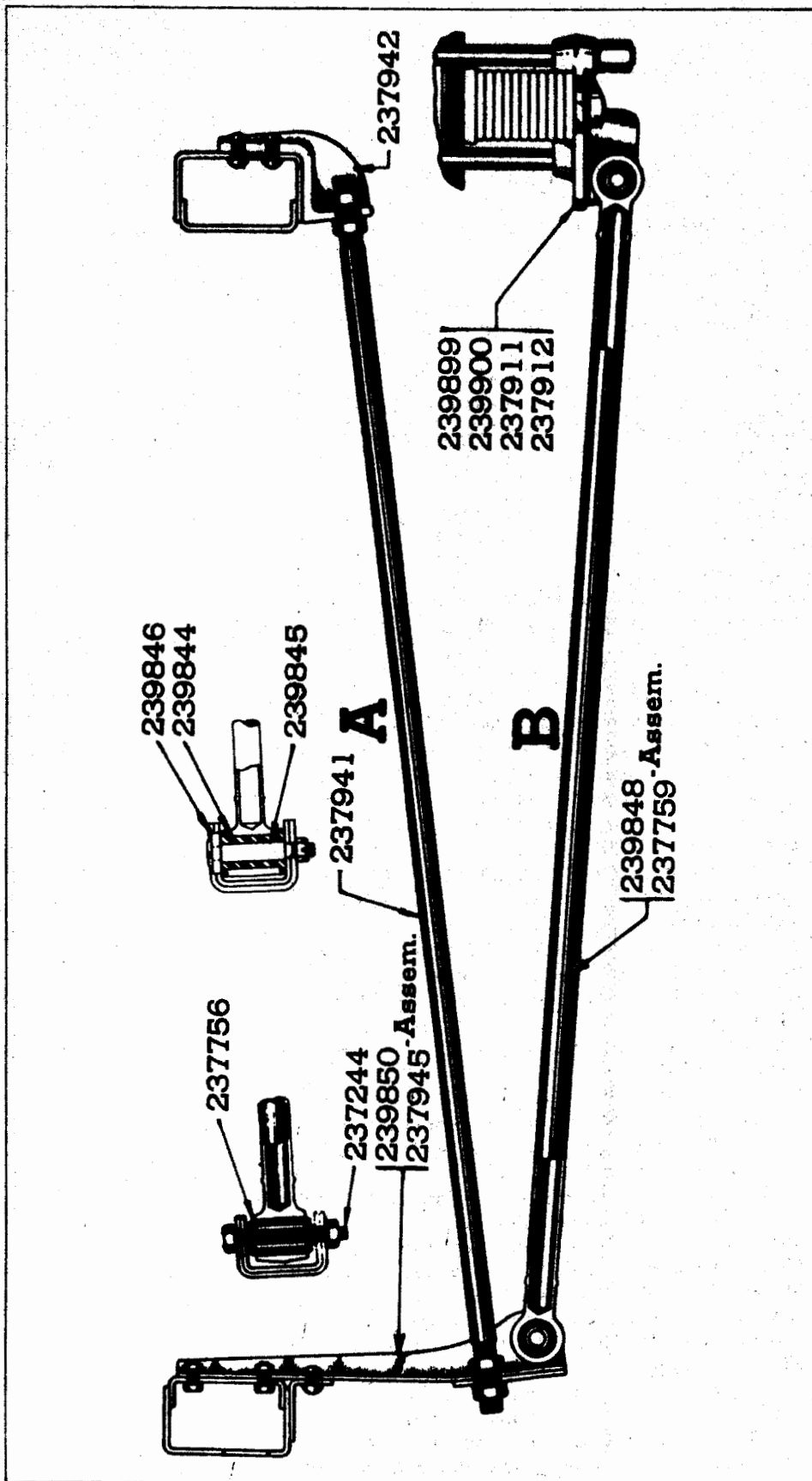

Models 1500-1-2-7-8, 1603-4-5-7-8, 1707-8

SERVICE PARTS LIST--PACKARD SUPER-EIGHT AND TWELVE

Steering 217

Piece No.	Name	1500	1506	1603	1607	1707	
		1501	1507	1604	1608	1708	
		1502	1508	1605	No. Required		
7008	Nut 1/2 (Use with bodies 1007-19-63-23-27-32-33-34-35-36-37-38-39-73-L394-L395)	2	2	-	-	-	
6047	Lockwasher 1/2 (Shakeproof) (Use with bodies 1007-19-63-27-23-32-33-34-35-36-37-38-39-73-L394-L395)	2	2	-	-	-	
239848	Stabilizer (lateral) tube and bush. retainerassy.	-	-	1	1	1	
239845	Stabilizer (lateral) tube bush. stud	-	-	2	2	2	
320534	Stabilizer (lateral) tube bush. stud nut	-	-	2	2	2	
239846	Stabilizer (lateral) tube bushing stud plug	-	-	2	2	2	
237949	Stabilizer rear to frame bracket	-	2	-	2	2	
7884	Screw	-	2	-	2	2	
7952	Screw 7/16-20 x 7/8 hex. hd.	-	2	-	2	2	
7007	Nut 7/16-20	-	2	-	2	2	
6045	Lockwasher 7/16 (Shakeproof)	-	4	-	4	4	
239258	Stabilizer rear link assembly (Use with 7/8" Dia. Rod) (Supersedes 237005)	-	2	-	2	2	
0341072	Stabilizer rear link assy. (Use with 3/4" Dia. Rod)	-	2	-	-	-	
0341073	Stabilizer rear link adjusting plug	-	4	-	-	-	
0341074	Stabilizer rear link cushion	-	8	-	-	-	
0341075	Stabilizer rear link cushion retainer	-	4	-	-	-	
221725	Stabilizer rear link grommet	-	4	-	4	4	
221721	Stabilizer rear link grommet retainer	-	4	-	4	4	
216371	Stabilizer rear link grommet retainer nut 7/16-20	-	2	-	2	2	
4291	Cotter pin 3/32 x 3/4	-	2	-	2	2	
0341088	Stabilizer rear link stud	-	2	-	-	-	
237006	Stabilizer rear link stud nut 1/2-20 self locking type	-	2	-	2	2	
231499	Stabilizer-rear rod	1	-	-	-	-	
240702	Stabilizer-rear rod	-	-	1	-	-	
237989	Stabilizer-rear rod (7/8" Dia.)	-	1	-	1	1	
0341089	Stabilizer-rear rod (3/4" Dia.)	-	1	-	-	-	
7835	Bolt 3/8-24 x 1-9/16 hex. hd.	4	-	4	-	-	
7006	Nut 3/8-24	4	-	4	-	-	
6048	Lockwasher 3/8 (Shakeproof)	4	-	4	-	-	
237990	Stabilizer-rear rod bearing (3/4" Dia. hole)	-	2	-	2	2	
0341090	Stabilizer-rear rod bearing (17/32" Dia. hole)	-	2	-	-	-	
304061	Stabilizer-rear rod shim 1/64 thick	x	-	x	-	-	
304060	Stabilizer-rear rod shim 1/32 thick	x	-	x	-	-	
304059	Stabilizer-rear rod shim 1/16 thick	x	-	x	-	-	

STEERING (CANE SHIFT)

231447	Steering column grommet	1	1	1	1	1
0239058	Steering column to instru. board bracket and cap	1	1	-	-	-
239683	Steering column to instru. board bracket (L.H. drive)	-	-	1	1	1
239684	Steering column to instru. board bracket (R.H. drive)	-	-	1	-	-
239682	Steering column to instru. board bracket cap	-	-	1	1	1
7724	Steering column to instru. board bracket cap screw 1/4-20 x 1 fill. hd.	2	2	2	2	2
6699	Lockwasher 1/4 internal (Shakeproof)	2	2	2	2	2
3907	Washer 1/4	2	2	2	2	2

Piece No.	Name	1500	1506	1603	1607	1707
		1501	1507	1604	1608	1708
		1502	1508	1605	No. Required	
223713	Steering column to instrument board bracket clamp plate	1	1	1	1	1
6077	Screw 1/2-20 x 1-3/8 hex. hd.	1	1	-	-	-
6517	Screw 1/2-20 x 1-1/4 hex. hd.	-	-	1	1	1
5133	Washer 1/2 plain	1	1	1	1	1
6673	Lockwasher 1/2 internal (Shakeproof)	1	1	1	1	1
7008	Nut 1/2-20	1	1	1	1	1
232969	Steering connecting rod assembly (L.H. drive) .	1	-	1	-	-
237515	Steering connecting rod assembly (R.H. drive) .	1	-	1	-	-
237060	Steering connecting rod assembly	-	1	-	-	-
240206	Steering connecting rod assembly	-	-	-	1	-
232968	Steering connecting rod	1	-	1	-	-
237059	Steering connecting rod	-	1	-	-	-
240205	Steering connecting rod	-	-	-	1	1
209228	Steering connecting rod adjusting plug	2	2	2	2	2
232040	Steering connecting rod ball socket spring seat (small)	1	1	1	1	1
232966	Steering connecting rod ball socket seat (large)	2	2	2	2	2
239038	Steering connecting rod ball socket (Supersedes 237459)	4	4	4	4	4
232039	Steering conn. rod ball joint housing (L.H. drive)	1	1	1	1	1
237514	Steering conn. rod ball joint housing (R.H. drive)	1	-	1	-	-
7820	Screw 3/8-24 x 1-3/8 hex. hd.	1	1	1	1	1
7006	Nut 3/8-24	1	1	1	1	1
6048	Lockwasher 3/8 internal (Shakeproof)	1	1	1	1	1
4312	Cotter pin 1/8 x 1-1/2	2	2	2	2	2
316260	Steering connecting rod ball seat spring--small	1	1	1	1	1
234608	Steering connecting rod ball seat spring--large	2	2	2	2	2
232024	Steering connecting rod dust cover	2	2	2	2	2
232025	Steering connecting rod dust cover spring	2	2	2	2	2
216549	Steering connecting rod lubricator (Alemite Zerk)	2	2	2	2	2
231439	Steering crank assembly (L.H. drive)	1	-	1	-	-
237286	Steering crank assembly (R.H. drive)	1	-	1	-	-
237056	Steering crank assembly	-	1	-	-	-
240112	Steering crank assembly	-	-	-	1	1
231432	Steering crank ball stud	1	1	1	1	1
302046	Steering crank bearing	2	-	2	-	-
232494	Steering crank bearing assembly	-	1	-	1	1
221432	Steering crank bearing dust washer	-	2	-	2	2
221441	Steering crank bearing dust washer retainer ...	-	2	-	2	2
311880	Steering crank bearing pin	1	-	1	-	-
232604	Steering crank bearing pin nut	1	-	1	-	-
302769	Steering crank bearing pin nut lock	1	-	1	-	-
231426	Steering crank housing assembly	1	-	1	-	-
240106	Steering crank housing (Supersedes 232612)	-	1	-	1	1
7823	Screw 3/8-24 x 15/16 hex. hd.	2	-	2	-	-
7006	Nut 3/8-24	2	-	2	-	-
6048	Lockwasher 3/8 internal (Shakeproof)	2	-	2	-	-
7890	Steering crank and housing assembly to frame screw 7/16-20 x 1-1/2 hex. hd.	-	4	-	4	4

SERVICE PARTS LIST--PACKARD SUPER-EIGHT AND TWELVE

Steering 219

Piece No.	Name	1500	1506	1603	1607	1707	
		1501	1507	1604	1608	1708	
		1502	1508	1605	No. Required		
5806	Lockwasher 7/16 internal (Shakeproof)	-	4	-	4	4	
7007	Nut 7/16-20	-	4	-	4	4	
232505	Steering crank housing cover	-	2	-	2	2	
232491	Steering crank housing cover gasket--thick	-	x	-	x	x	
232686	Steering crank housing cover gasket--thin	-	x	-	x	x	
5449	Screw 5/16-24 x 3/4 hex. hd.	-	6	-	6	6	
6044	Lockwasher 5/16 internal (Shakeproof)	-	6	-	6	6	
234540	Steering cross tube assembly	2	-	2	-	-	
239300	Steering cross tube assembly--left (Supersedes 237057)	-	1	-	-	-	
240210	Steering cross tube assembly--left	-	-	-	1	1	
239301	Steering cross tube assembly--right (Supersedes 237057)	-	1	-	-	-	
240211	Steering cross tube assembly--right	-	-	-	1	1	
234541	Steering cross tube	2	-	2	-	-	
237058	Steering cross tube (Prior to Motor No. 906133) ..	-	2	-	-	-	
239255	Steering cross tube (After Motor No. 906132) ..	-	2	-	2	2	
232679	Steering cross tube bearing assembly--right-short	-	1	-	-	-	
240136	Steering cross tube bearing assembly--right-short	-	-	-	1	1	
232678	Steering cross tube bearing assembly--left-short	-	1	-	-	-	
240135	Steering cross tube bearing assembly--left-short	-	-	-	1	1	
239256	Steering cross tube bearing assembly--left-long ..	-	1	-	-	-	
240295	Steering cross tube bearing assembly--left-long ..	-	-	-	1	1	
239302	Steering cross tube bearing assembly--right-long	-	1	-	-	-	
240296	Steering cross tube bearing assembly--right-long	-	-	-	1	1	
234542	Steering cross tube bearing assembly--right ...	2	-	2	-	-	
234543	Steering cross tube bearing assembly--left	2	-	2	-	-	
216548	Steering cross tube bearing lubricator connector (Alemite Zerk)	4	4	4	4	4	
303475	Steering cross tube clamp	4	-	4	-	-	
232677	Steering cross tube clamp	-	4	-	4	4	
5890	Screw 5/16-24 x 1-1/4 hex. hd.	4	-	4	-	-	
5561	Screw 7/16-20 x 1-7/8 hex. hd.	-	4	-	4	4	
6044	Lockwasher 5/16 internal (Shakeproof)	4	-	4	-	-	
5806	Lockwasher 7/16 internal (Shakeproof)	-	4	-	4	4	
7005	Nut 5/16-24	4	-	4	-	-	
7007	Nut 7/16-20	-	4	-	4	4	
234551	Steering cross tube stud dust seal	4	-	4	-	-	
232682	Steering cross tube stud dust seal	-	4	-	4	4	
234558	Steering cross tube stud dust seal spring	4	4	4	4	4	
234550	Steering cross tube stud dust seal washer	8	-	8	-	-	
232680	Steering cross tube stud dust seal washer--large	-	4	-	4	4	
232681	Steering cross tube stud dust seal washer--small	-	4	-	4	4	

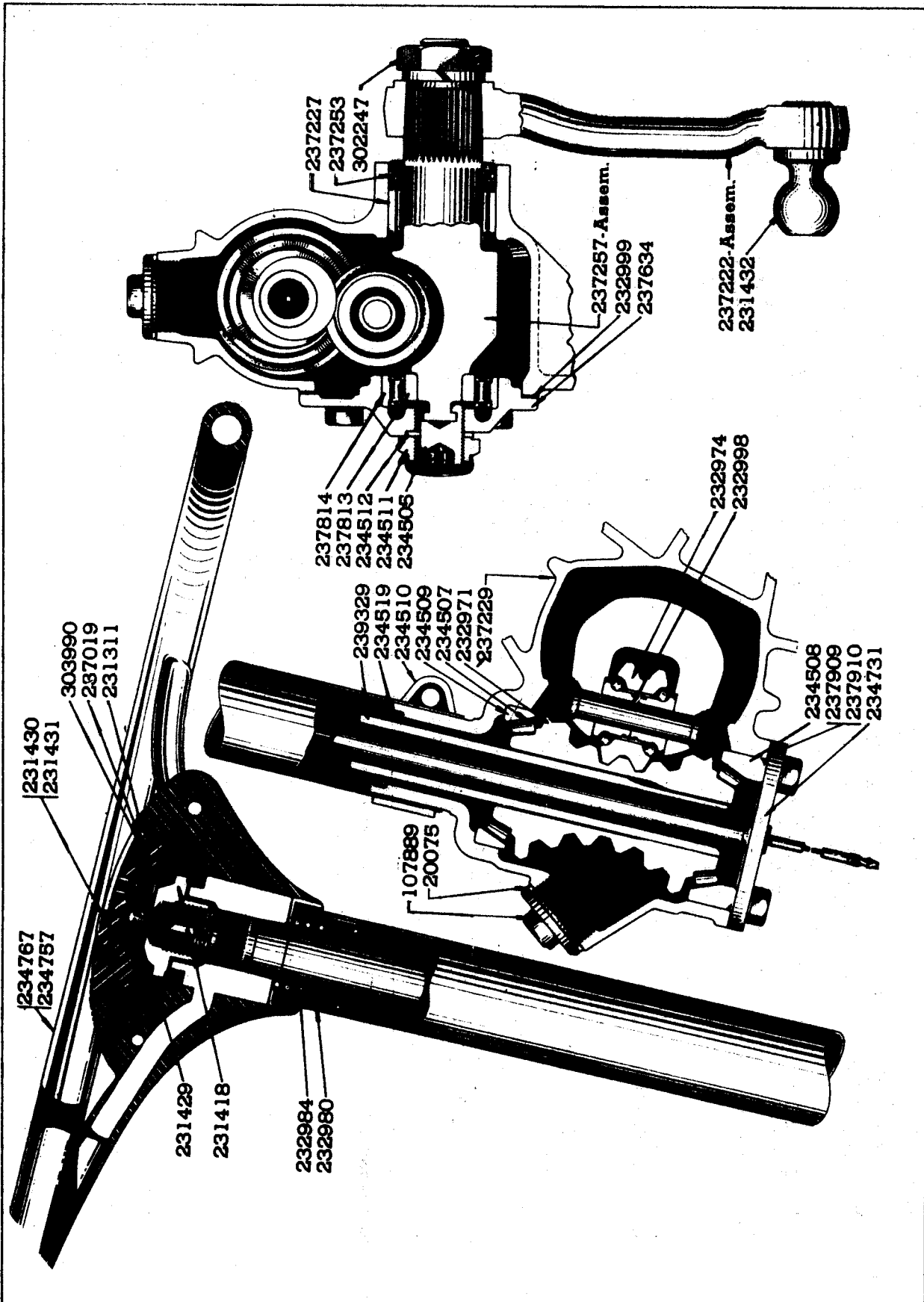

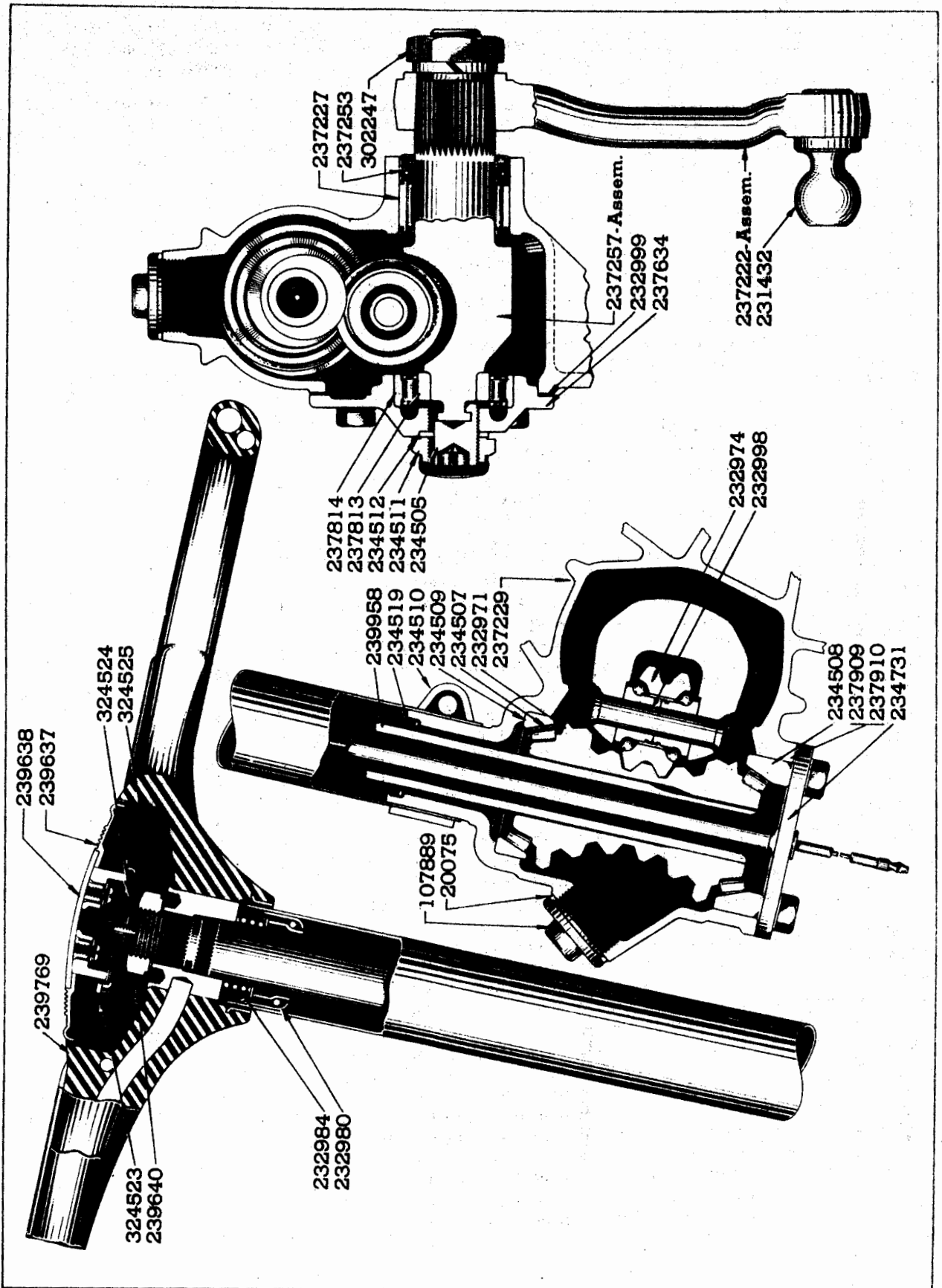

Models 1603-4-5-7-8

Piece No.	Name	1500	1506	1603	1607	1707	
		1501	1507	1604	1608	1708	
		1502	1508	1605	No. Required		
303515	Steering cross tube stud nut	4	-	4	-	-	
240154	Steering cross tube stud nut	-	-	-	4	4	
7110	Steering cross tube stud nut	-	4	-	-	-	
4291	Cotter pin 3/32 x 3/4	4	-	4	-	-	
4306	Cotter pin 1/8 x 1	-	4	-	4	4	
231365	Steering gear assembly (L.H. drive)	1	-	-	-	-	
232646	Steering gear assembly	-	1	-	-	-	
239674	Steering gear assembly (L.H. drive)	-	-	1	-	-	
239676	Steering gear assembly	-	-	-	1	1	
237319	Steering gear assembly (R.H. drive)	1	-	-	-	-	
239675	Steering gear assembly (R.H. drive)	-	-	1	-	-	
231428	Steering gear assembly to frame bolt 7/16-20 x 5-1/2 hex. hd.	3	3	3	3	3	
7007	Nut 7/16-20	3	3	3	3	3	
6045	Lockwasher 7/16 internal (Shakeproof)	3	3	3	3	3	
131046	Plain washer 7/16 special	2	2	2	2	2	
237519	Steering gear bolt spacer--long (R.H. drive) ..	1	-	1	-	-	
237520	Steering gear bolt spacer--intermediate (R.H. drive)	1	-	1	-	-	
237521	Steering gear bolt spacer--short (R.H. drive) .	1	-	1	-	-	
237229	Steering gear case assembly (L.H. drive)	1	1	1	1	1	
237321	Steering gear case assembly (R.H. drive)	1	-	1	-	-	
237634	Steering gear case cross shaft cover	1	1	1	1	1	
232999	Steering gear case cross shaft cover gasket ...	1	1	1	1	1	
6720	Steering gear case cross shaft cover stud	4	4	4	4	4	
7006	Nut 3/8-24	4	4	4	4	4	
6048	Lockwasher 3/8 internal (Shakeproof)	4	4	4	4	4	
107889	Steering gear case oil filler plug	1	1	1	1	1	
20075	Steering gear case oil filler plug gasket	1	1	1	1	1	
6720	Steering gear case worm cover stud	4	4	4	4	4	
6048	Lockwasher 3/8 internal (Shakeproof)	4	4	4	4	4	
7006	Nut	4	4	4	4	4	
237910	Steering gear case worm cover shim--thick	x	x	x	x	x	
237909	Steering gear case worm cover shim--thin	x	x	x	x	x	
239044	Steering gear case worm cover shim--medium	x	x	x	x	x	
234731	Steering gear case worm cover grease retaining tube assembly	1	1	1	1	1	
237257	Steering gear cross shaft assembly (L.H. drive)	1	1	1	1	1	
237322	Steering gear cross shaft assembly (R.H. drive)	1	-	1	-	-	
234505	Steering gear cross shaft adjusting screw	1	1	1	1	1	
234511	Steering gear cross shaft adjusting screw locknut 7/8-20 blind	1	1	1	1	1	
234512	Steering gear cross shaft adjusting screw lock plate	1	1	1	1	1	
237227	Steering gear cross shaft bearing--inner	1	1	1	1	1	
237814	Steering gear cross shaft bearing--outer	1	1	1	1	1	
237813	Steering gear cross shaft bearing--outer-inner race	1	1	1	1	1	
237222	Steering gear cross shaft lever assembly (L.H. drive)	1	1	1	1	1	
237325	Steering gear cross shaft lever assembly (R.H. drive)	1	-	1	-	-	

SERVICE PARTS LIST - PACKARD SUPER EIGHT AND TWELVE

Steering 223

Piece No.	Name	1500	1506	1603	1607	1707
		1501	1507	1604	1608	1708
		1502	1508	1605	No. Required	
231432	Steering gear cross shaft lever ball stud	1	1	1	1	1
302247	Steering gear cross shaft lever nut	1	1	1	1	1
5520	Lockwasher 7/8	1	1	1	1	1
237253	Steering gear cross shaft oil seal assembly ...	1	1	1	1	1
232974	Steering gear cross shaft roller assembly	1	1	1	1	1
232998	Steering gear cross shaft roller pin	1	1	1	1	1
239637	Steering gear horn button (Antiqua tan)	-	-	1	1	1
242362	Steering gear horn button (Gypsy brown)	-	-	1	1	1
201736	Steering gear horn button cable terminal	1	1	-	-	-
240635	Steering gear horn button cable terminal	-	-	1	1	1
324520	Steering gear horn button cable terminal insulator	-	-	1	1	1
324517	Steering gear horn button cable assembly	-	-	1	1	1
324525	Steering gear horn button contact cup	-	-	1	1	1
324524	Steering gear horn button contact plate	-	-	1	1	1
239678	Steering gear horn button contact plate insulator	-	-	1	1	1
231429	Steering gear horn button contact plate and cable assembly	1	1	-	-	-
231430	Steering gear horn button and emblem assembly .	1	-	-	-	-
231431	Steering gear horn button and emblem assembly .	-	1	-	-	-
231420	Steering gear horn button emblem	1	-	-	-	-
231417	Steering gear horn button emblem	-	1	-	-	-
239638	Steering gear horn button emblem	-	-	1	1	1
203819	Steering gear horn button emblem screw	-	2	2	2	2
5861	Lockwasher No. 8 internal (Shakeproof) ...	-	2	2	2	2
6387	Plain washer No. 8 (Special)	-	2	2	2	2
303990	Steering gear horn button spring	1	1	-	-	-
237019	Steering gear horn button stabilizer spring ...	1	1	-	-	-
231311	Steering gear horn button retainer	1	1	-	-	-
239640	Steering gear horn button retainer	-	-	1	1	1
324523	Steering gear horn button retainer spring	-	-	1	1	1
324519	Steering gear horn button terminal--upper end .	-	-	1	1	1
303490	Steering gear horn button wire terminal--upper.	1	1	-	-	-
0239329	Steering gear shaft and worm assembly (L.H. drive)	1	1	-	-	-
239958	Steering gear shaft and worm assembly (L.H. drive)	-	-	1	1	1
0239327	Steering gear shaft and worm assembly (R.H. drive)	1	-	-	-	-
239959	Steering gear shaft and worm assembly (R.H. drive)	-	-	1	-	-
232980	Steering gear shaft bearing assembly	1	1	1	1	1
232984	Steering gear shaft bearing retaining spring ..	1	1	1	1	1
234519	Steering gear shaft oil seal assembly	1	1	1	1	1
234516	Steering gear tube and bearing assembly	1	-	-	-	-
239670	Steering gear tube and bearing assembly (Antiqua tan).....	-	-	1	-	-
330591	Steering gear tube and bearing assembly (Gypsy brown)	-	-	1	-	-
234518	Steering gear tube and bearing assembly	-	1	-	-	-

Piece No.	Name	1500	1506	1603	1607	1707	
		1501	1507	1604	1608	1708	
		1502	1508	1605	No. Required		
239672	Steering gear tube and bearing assembly	-	-	-	1	1	
234510	Steering gear tube clamp	1	1	1	1	1	
5753	Screw 5/16-24 x 1-7/8 hex. hd.	1	1	1	1	1	
6044	Lockwasher 5/16 internal (Shakeproof)	1	1	1	1	1	
7005	Nut 5/16-24	1	1	1	1	1	
231418	Steering gear wheel nut	1	1	-	-	-	
239677	Steering gear wheel nut	-	-	1	1	1	
232971	Steering gear worm (L.H. drive)	1	1	1	1	1	
237296	Steering worm (R.H. drive)	1	-	1	-	-	
234508	Steering gear worm bearing adjusting ring	1	1	1	1	1	
234507	Steering gear worm bearing cage and rollers assembly	2	2	2	2	2	
234509	Steering gear worm bearing cup	1	1	1	1	1	
234767	Steering wheel assembly	1	-	-	-	-	
234757	Steering wheel assembly	-	1	-	-	-	
239769	Steering wheel assembly (Antiqua tan)	-	-	1	1	-	
242360	Steering wheel assembly (Gypsy brown)	-	-	1	1	-	
242402	Steering wheel assembly	-	-	-	-	1	

STEERING (COLUMN SHIFT)

242797	Steering column and bearing assembly	-	-	-	-	1
234510	Steering column clamp	-	-	-	-	1
5753	Screw 5/16-24 x 1-7/8 hex. hd.	-	-	-	-	1
6044	Lockwasher 5/16 Shakeproof	-	-	-	-	1
7005	Nut 5/16-24	-	-	-	-	1
242831	Steering column gear shift (first and reverse) idler lever assembly	-	-	-	-	1
242838	Steering column gear shift (direct and second) idler lever assembly	-	-	-	-	1
242844	Steering column gear shift (first and reverse) idler lever pin	-	-	-	-	1
242824	Steering column gear shift (direct and second) idler lever washer	-	-	-	-	1
335866	Steering column gear shift idler lever hub bushing	-	-	-	-	4
333761	Steering column gear shift (direct and second) idler lever hub friction washer	-	-	-	-	1
242828	Steering column gear shift idler lever shaft assembly bracket	-	-	-	-	1
7823	Screw 3/8-24 x 15/16 hex. hd.	-	-	-	-	2
5506	Lockwasher 3/8	-	-	-	-	2
7006	Nut 3/8-24 plain	-	-	-	-	2
316934	Steering column gear shift idler lever shaft assembly bracket screw plain washer 17/32 x 1 x 1/8	-	-	-	-	1
242834	Steering column gear shift idler lever shaft ..	-	-	-	-	1
7008	Steering column gear shift idler lever shaft nut 1/2-20	-	-	-	-	1
5510	Lockwasher 1/2	-	-	-	-	1

SERVICE PARTS LIST--PACKARD SUPER-EIGHT AND TWELVE

Steering (Column Shift) 225

Piece No.	Name	1500	1506	1603	1607	1707	
		1501	1507	1604	1608	1708	
		1502	1508	1605	No. Required		
3884	Steering column gear shift idler lever retaining washer 1/2 plain "N"	-	-	-	-	1	
4305	Cotter pin 1/8 x 7/8	-	-	-	-	1	
242854	Steering column gear shift idler lever spring .	-	-	-	-	1	
242823	Steering column gear shift (first and reverse) idler lever to transmission rod	-	-	-	-	1	
242774	Steering column gear shift (direct and second) idler lever to transmission rod	-	-	-	-	1	
3874	Steering column gear shift idler lever to transmission rod retaining washer 5/16 plain "N"	-	-	-	-	2	
330344	Steering column gear shift idler lever to transmission rod retaining spring washer 5/16	-	-	-	-	2	
4280	Cotter pin 1/16 x 1/2	-	-	-	-	2	
333146	Steering column gear shift idler lever rod insulator bushing	-	-	-	-	4	
333181	Steering column gear shift idler lever rod insulator bushing spacer	-	-	-	-	4	
338405	Washer 5/16	-	-	-	-	4	
4290	Cotter pin 3/32 x 5/8	-	-	-	-	4	
330344	Spring washer 5/16	-	-	-	-	2	
242772	Steering column gear shift lever	-	-	-	-	1	
330394	Steering column gear shift lever boot	-	-	-	-	1	
330922	Steering column gear shift lever housing	-	-	-	-	1	
330939	Steering column gear shift lever housing bracket	-	-	-	-	1	
242761	Steering column gear shift lever knob	-	-	-	-	1	
333826	Steering column gear shift lever knob trim ring	-	-	-	-	1	
335594	Steering column gear shift lever pin	-	-	-	-	1	
4290	Cotter pin 3/32 x 5/8	-	-	-	-	1	
330344	Spring washer 5/16	-	-	-	-	1	
333151	Steering column gear shift selector	-	-	-	-	1	
333154	Steering column gear shift selector pin	-	-	-	-	1	
242765	Steering column gear shift selector rod assy. .	-	-	-	-	1	
333789	Steering column gear shift selector rod anti-rattler	-	-	-	-	1	
330936	Steering column gear shift selector rod end plunger	-	-	-	-	1	
330937	Steering column gear shift selector rod end plunger spring	-	-	-	-	1	
333201	Steering column gear shift selector rod spring.	-	-	-	-	1	
333204	Steering column gear shift selector rod spring retainer	-	-	-	-	1	
4306	Cotter pin 1/8 x 1	-	-	-	-	1	
242764	Steering column gear shift shaft	-	-	-	-	1	
338044	Steering column gear shift shaft anti-rattle spring	-	-	-	-	1	
338043	Spring plug	-	-	-	-	1	
333013	Steering column gear shift shaft bracket	-	-	-	-	1	
333018	Steering column gear shift shaft bracket clamp.	-	-	-	-	1	
7004	Nut 1/4-28	-	-	-	-	2	

Piece No.	Name	1500	1506	1603	1607	1707
		1501	1507	1604	1608	1708
		1502	1508	1605	No. Required	
5502	Lockwasher	-	-	-	-	2
242803	Steering column gear shift shaft (first and reverse) lever	-	-	-	-	1
309841	Steering column gear shift shaft (first and reverse) lever retaining washer	-	-	-	-	1
225615	Steering column gear shift shaft (first and reverse) lever spring washer	-	-	-	-	1
324007	Steering column gear shift shaft (first and reverse) lever retaining ring	-	-	-	-	1
333534	Steering column gear shift shaft (second and direct) lever	-	-	-	-	1
114316	Steering column gear shift shaft (second and direct) lever retaining washer	-	-	-	-	1
333189	Steering column gear shift shaft (second and direct) lever spring washer	-	-	-	-	1
333171	Steering column gear shift shaft (second and direct) lever retaining ring	-	-	-	-	1
242835	Steering column gear shift (direct and second) shaft lever to idler lever rod-lower	-	-	-	-	1
242836	Steering column gear shift (first and reverse) shaft lever to idler lever rod-lower	-	-	-	-	1
242833	Steering column gear shift (direct and second) shaft lever to idler lever rod-upper	-	-	-	-	1
242832	Steering column gear shift (first and reverse) shaft lever to idler lever rod-upper	-	-	-	-	1
3874	Washer 5/16	-	-	-	-	2
330344	Spring washer 5/16	-	-	-	-	2
4290	Cotter pin 3/32 x 5/8	-	-	-	-	2
335512	Steering column gear shift shaft lever to idler lever rod turnbuckle	-	-	-	-	2
335513	Steering column gear shift shaft lever to idler lever rod turnbuckle lock nut (RH thread) ...	-	-	-	-	2
335514	Steering column gear shift shaft lever to idler lever rod turnbuckle lock nut (LH thread) ...	-	-	-	-	2
242826	Steering column gear shift (first and reverse) transmission lever (make from 333164)	-	-	-	-	1
242825	Steering column gear shift (direct and second) transmission lever (make from 333164)	-	-	-	-	1
7828	Clamp screw 5/16-24 x 1-1/8 hex. hd.	-	-	-	-	2
5504	Lockwasher 5/16	-	-	-	-	2
242762	Steering column grommet	-	-	-	-	1
242848	Steering column to instrument board bracket and cap assembly	-	-	-	-	1
242847	Steering column to instrument board bracket cap	-	-	-	-	1
7724	Screw 1/4-20 x 1" fill. hd.	-	-	-	-	2
6699	Lockwasher 1/4	-	-	-	-	2
3907	Washer 1/4"	-	-	-	-	2
223713	Steering column to instrument board bracket clamp plate	-	-	-	-	1
6516	Screw 1/2-20 x 1-1/4 hex. hd. (Make from 6517)	-	-	-	-	1
5133	Washer 1/2	-	-	-	-	1

SERVICE PARTS LIST--PACKARD SUPER-EIGHT AND TWELVE

Steering (Column Shift) 227

Piece No.	Name	1500	1506	1603	1607	1707
		1501	1507	1604	1608	1708
		1502	1508	1605	No. Required	
7008	Nut 1/2-20	-	-	-	-	1
6673	Lockwasher 1/2" Shakeproof	-	-	-	-	1
240206	Steering connecting rod assembly	-	-	-	-	1
240205	Steering connecting rod	-	-	-	-	1
209228	Steering connecting rod adjusting plug	-	-	-	-	2
232039	Steering connecting rod ball joint housing	-	-	-	-	1
239038	Steering connecting rod ball socket	-	-	-	-	4
232966	Steering connecting rod ball socket seat--large	-	-	-	-	2
232040	Steering connecting rod ball socket spring seat--small	-	-	-	-	1
7820	Steering connecting rod ball socket spring seat screw 3/8-24 x 1-3/8 hex. hd.	-	-	-	-	1
7006	Nut 3/8-24	-	-	-	-	1
6048	Lockwasher 3/8 Shakeproof	-	-	-	-	1
4312	Cotter pin 1/8 x 1-1/2	-	-	-	-	2
316260	Steering connecting rod ball seat spring--small	-	-	-	-	1
234608	Steering connecting rod ball seat spring--large	-	-	-	-	2
232024	Steering connecting rod dust cover	-	-	-	-	2
232025	Steering connecting rod dust cover spring	-	-	-	-	2
216549	Steering connecting rod oiler (Alemite Zerk No. 1612)	-	-	-	-	2
240112	Steering crank assembly	-	-	-	-	1
231432	Steering crank ball stud	-	-	-	-	1
232494	Steering crank bearing assembly	-	-	-	-	1
221432	Steering crank bearing dust washer	-	-	-	-	2
221441	Steering crank bearing dust washer retainer ...	-	-	-	-	2
240106	Steering crank housing	-	-	-	-	1
7890	Steering crank and housing assembly to frame screw 7/16-20 x 1-1/2 hex. hd.	-	-	-	-	4
5806	Lockwasher 7/16 Shakeproof	-	-	-	-	4
7007	Nut 7/16-20	-	-	-	-	4
232505	Steering crank housing cover	-	-	-	-	2
232491	Steering crank housing cover gasket--thick	-	-	-	-	x
232686	Steering crank housing cover gasket--thin	-	-	-	-	x
5449	Steering crank housing cover screw 5/16-24 x 3/4 hex. hd.	-	-	-	-	6
6044	Lockwasher 5/16 Shakeproof	-	-	-	-	6
240210	Steering cross tube assembly--left	-	-	-	-	1
240211	Steering cross tube assembly--right	-	-	-	-	1
239255	Steering cross tube	-	-	-	-	2
240295	Steering cross tube bearing assembly--long (LH thread)	-	-	-	-	1
240296	Steering cross tube bearing assembly--long (RH thread)	-	-	-	-	1
240135	Steering cross tube bearing assembly--short (LH thread)	-	-	-	-	1
240136	Steering cross tube bearing assembly--short (RH thread)	-	-	-	-	1
216548	Steering cross tube bearing oiler (Alemite Zerk No. 1610)	-	-	-	-	4
232677	Steering cross tube clamp	-	-	-	-	4

Piece No.	Name	1500	1506	1603	1607	1707
		1501	1507	1604	1608	1708
		1502	1508	1605	No. Required	
5561	Screw 7/16-20 x 1-7/8 hex. hd.	-	-	-	-	4
5806	Lockwasher 7/16 Shakeproof	-	-	-	-	4
7007	Nut 7/16-20	-	-	-	-	4
232682	Steering cross tube stud dust seal	-	-	-	-	4
232680	Steering cross tube stud dust seal washer-- large	-	-	-	-	4
232681	Steering cross tube stud dust seal washer-- small	-	-	-	-	4
240154	Steering cross tube stud nut	-	-	-	-	4
4306	Cotter pin 1/8 x 1	-	-	-	-	4
242820	Steering gear assembly	-	-	-	-	1
231428	Steering gear assembly to frame bolt 7/16-20 x 5-1/2 hex. hd.	-	-	-	-	3
7007	Nut 7/16-20	-	-	-	-	3
6045	Lockwasher 7/16 Shakeproof	-	-	-	-	3
131046	Plain washer 7/16 special	-	-	-	-	2
237521	Steering gear bolt spacer--short	-	-	-	-	1
242630	Steering gear case assembly	-	-	-	-	1
338639	Steering gear case to column dowel	-	-	-	-	1
237634	Steering gear case cross shaft cover	-	-	-	-	1
232999	Steering gear case cross shaft cover gasket ...	-	-	-	-	1
6720	Steering gear case cross shaft cover stud	-	-	-	-	4
7006	Nut 3/8-24	-	-	-	-	4
6048	Lockwasher 3/8 Shakeproof	-	-	-	-	4
107889	Steering gear base oil filler plug	-	-	-	-	1
20075	Steering gear case oil filler plug gasket	-	-	-	-	1
6720	Steering gear case worm cover stud	-	-	-	-	4
7006	Nut 3/8-24	-	-	-	-	4
6048	Lockwasher 3/8 Shakeproof	-	-	-	-	4
239044	Steering gear case worm cover shim--medium	-	-	-	-	x
237910	Steering gear case worm cover shim--thick	-	-	-	-	x
237909	Steering gear case worm cover shim--thin	-	-	-	-	x
234731	Steering gear case worm cover grease retaining tube assembly	-	-	-	-	1
338168	Steering gear case worm cover grease retaining tube gasket	-	-	-	-	1
237257	Steering gear cross shaft assembly	-	-	-	-	1
234505	Steering gear cross shaft adjusting screw	-	-	-	-	1
234511	Steering gear cross shaft adjusting screw locknut 7/8-20 blind	-	-	-	-	1
234512	Steering gear cross shaft adjusting screw lock plate	-	-	-	-	1
237227	Steering gear cross shaft bearing--inner	-	-	-	-	1
237814	Steering gear cross shaft bearing--outer	-	-	-	-	1
237813	Steering gear cross shaft bearing--outer-inner race	-	-	-	-	1
237222	Steering gear cross shaft lever assembly	-	-	-	-	1
231432	Steering gear cross shaft lever ball stud	-	-	-	-	1
302247	Steering gear cross shaft lever nut	-	-	-	-	1
5520	Steering gear cross shaft lever lockwasher	-	-	-	-	1
237253	Steering gear cross shaft oil seal assembly ...	-	-	-	-	1

SERVICE PARTS LIST--PACKARD SUPER-EIGHT AND TWELVE

Toe Board 229

Piece No.	Name	1500	1506	1603	1607	1707
		1501	1507	1604	1608	1708
		1502	1508	1605	No. Required	
232974	Steering gear cross shaft roller assembly	-	-	-	-	1
232998	Steering gear cross shaft roller pin	-	-	-	-	1
242362	Steering gear horn button	-	-	-	-	1
240635	Steering gear horn button cable terminal	-	-	-	-	1
324520	Steering gear horn button cable terminal insulator	-	-	-	-	1
324517	Steering gear horn button cable assembly	-	-	-	-	1
324525	Steering gear horn button contact cup	-	-	-	-	1
324524	Steering gear horn button contact plate	-	-	-	-	1
239678	Steering gear horn button contact plate insulator	-	-	-	-	1
239638	Steering gear horn button emblem	-	-	-	-	1
203819	Steering gear horn button emblem screw	-	-	-	-	2
5861	Lockwasher No. 8 Shakeproof	-	-	-	-	2
6387	Plain washer No. 8 Special	-	-	-	-	2
239640	Steering gear horn button retainer	-	-	-	-	1
324523	Steering gear horn button retainer spring	-	-	-	-	1
324519	Steering gear horn button cable terminal--upper end	-	-	-	-	1
323778	Steering gear shaft bearing assembly	-	-	-	-	1
335986	Steering gear shaft bearing retaining spring ..	-	-	-	-	1
234519	Steering gear shaft oil seal assembly	-	-	-	-	1
242788	Steering gear shaft and worm assembly	-	-	-	-	1
232971	Steering gear worm	-	-	-	-	1
234508	Steering gear worm bearing adjusting ring	-	-	-	-	1
234507	Steering gear worm bearing cage and rollers assembly	-	-	-	-	2
234509	Steering gear worm bearing cup	-	-	-	-	1
335345	Steering wheel assembly	-	-	-	-	1
335380	Steering wheel nut (3/4 Special)	-	-	-	-	1
338692	Steering wheel nut washer	-	-	-	-	1

TOE BOARD

232453	Toe board assembly (L.H. drive) (Use with cane shift steering)	1	1	1	1	1
242802	Toe board assembly (Use with column shift steering)	-	-	-	-	1
237511	Toe board assembly (R.H. drive)	1	-	1	-	-
237011	Toe board accelerator pedal stop (L.H. drive) .	1	1	1	1	1
7005	Nut 5/16-24 (L.H. drive)	2	2	2	2	2
221405	Toe board change speed lever support liner	1	1	1	1	1
221406	Toe board change speed lever support liner plate	1	1	1	1	1
132776	Toe board change speed lever support liner plate rivet No. 2132 x 11/32 flat head tubular	7	7	7	7	7
221942	Toe board clutch pedal spring	1	1	1	1	1
5485	Bolt 1/4-28 x 5/8 carriage	1	1	1	1	1
7004	Nut 1/4-28	1	1	1	1	1

Piece No.	Name	1500	1506	1603	1607	1707
		1501	1507	1604	1608	1708
		1502	1508	1605	No. Required	
5502	Lockwasher 1/4	1	1	1	1	1
3877	Washer 3/8	1	1	1	1	1
209486	Toe board clutch pedal spring pad	1	1	1	1	1
48317	Toe board clutch pedal spring pad rivet	1	1	1	1	1
232322	Toe board insulation	1	1	-	-	-
239745	Toe board insulator assembly (L.H. drive) (Use with cane shift steering)	-	-	1	1	1
242800	Toe board insulator assembly (Use with column shift steering)	-	-	-	-	1
239765	Toe board insulator assembly (R.H. drive)	-	-	1	-	-
6252	Rivet 3/16 x 1 oval head	8	8	-	-	-
3867	Washer 3/16 (Special)	8	8	-	-	-
221629	Toe board liner side	2	2	2	2	2
48317	Rivet 9/64 x 9/32	8	8	8	8	8
205954	Toe board pedal hole bumper	2	2	2	2	2
205953	Toe board pedal hole dust cover	2	2	2	2	2
5315	Toe board screw (top) 1/4-28 x 1-3/8 hex. hd. .	5	5	2	2	2
5317	Screw (top) 1/4-28 x 1-1/8" hex. hd.	-	-	3	3	3
5447	Lockwasher 1/4 (Shakeproof)	5	5	5	5	5
5251	Toe board screw (side) 1/4-28 x 1 fill. hd. ...	2	2	2	2	2
5502	Lockwasher 1/4	2	2	2	2	2
119143	Toe board screw boss 1/4-28	2	2	2	2	2

TOOLS

190681	Tool roll	1	1	1	1	1
237829	Tool roll-equipped	1	1	1	1	1
128287	Tool-hammer	1	1	1	1	1
0213029	Tool jack and handle	1	1	1	1	1
311682	Tool and jack bag	1	1	1	1	1
232854	Tool jack handle	1	1	1	1	1
311896	Tool grease gun (Supersedes 303241)	1	1	1	1	1
128288	Tool-monkey wrench	1	1	1	1	1
128289	Tool pliers	1	1	1	1	1
71030	Tool-punch	1	1	1	1	1
128290	Tool-screw driver (3" blade)	1	1	1	1	1
128291	Tool-screw driver (6" blade)	1	1	1	1	1
237879	Tool-spark plug wrench and handle assembly	1	1	1	1	1
239748	Tool tire pump (Supersedes 210404)	1	1	1	1	1
47669	Tool-wrench 15 degrees double head (1/4 and 5/16 openings)	1	1	1	1	1
46707	Tool-wrench 15 degrees double head (7/16 and 1/2 openings)	1	1	1	1	1
45706	Tool-wrench 15 degrees double head (5/16 and 5/8 openings)	1	1	1	1	1
115773	Tool-wrench 15 degrees single head (9/16 opening-special)	1	1	1	1	1
115774	Tool-wrench 15 degrees double head (3/4 x 13/16 openings)	1	1	1	1	1
237401	Tool-wheel and jack wrench	1	1	1	1	1

SERVICE PARTS LIST--PACKARD SUPER-EIGHT AND TWELVE

Transmission 231

Piece No.	Name	1500	1506	1603	1607	1707	
		1501	1507	1604	1608	1708	
		1502	1508	1605	No. Required		
TRANSMISSION							
0239049	Transmission assembly (18-6 speedometer ratio) (4.69 to 1 ratio) (Standard)	1	-	1	-	-	
0239050	Transmission assembly (17-6 speedometer ratio) (4.36 to 1 ratio) (Special)	1	-	1	-	-	
0239051	Transmission assembly (16-5 speedometer ratio) (4.9 to 1 rear axle ratio) (Special)	1	-	1	-	-	
0239052	Transmission assembly (17-6 speedometer ratio) (4.41 to 1 ratio) (Standard) (Use with cane shift steering)	-	1	-	1	1	
0239053	Transmission assembly (26-10 speedometer ratio) (4.06 to 1 ratio) (Special) (Use with cane shift steering)	-	1	-	1	1	
0239054	Transmission assembly (18-6 speedometer ratio) (4.69 to 1 ratio) (Special) (Use with cane shift steering)	-	1	-	1	1	
242807	Transmission assembly (4.41 to 1 ratio) (Standard) (Use with column shift steering) ..	-	-	-	-	1	
242806	Transmission assembly (4.06 to 1 ratio) (Special) (Use with column shift steering) ..	-	-	-	-	1	
242808	Transmission assembly (4.69 to 1 ratio) (Special) (Use with column shift steering) ..	-	-	-	-	1	
215371	Transmission backing light switch (Use with cane shift steering)	1	1	1	1	1	
242798	Transmission backing light switch (Use with column shift steering)	-	-	-	-	1	
6650	Screw 1/4-20 x 1/2 hex. hd. (Use with column shift steering)	-	-	-	-	2	
3868	Washer 1/4 (Use with column shift steering) ..	-	-	-	-	1	
5502	Lockwasher 1/4 (Use with column shift steering)	-	-	-	-	2	
242804	Transmission backing light switch seal (Use with column shift steering)	-	-	-	-	1	
145255	Transmission backing light switch cable clip (Use with column shift steering)	-	-	-	-	1	
157696	Transmission backing light switch cable clip (Use with cane shift steering)	1	1	1	1	1	
237337	Transmission case and plug assembly (Use with cane shift steering)	1	1	1	1	1	
242787	Transmission case (Use with column shift steering)	-	-	-	-	1	
7822	Transmission case to crankcase screw 3/8-24 x 1-1/2 hex. hd.	2	-	2	-	-	
7841	Screw 3/8-24 x 1-1/4 hex. hd.	2	-	2	-	-	
5506	Lockwasher 3/8	4	-	4	-	-	
225107	Transmission case cover	1	1	1	1	1	
242794	Transmission case cover screw (Use with column shift steering)	-	-	-	-	1	
330347	Transmission case cover screw breather cap (Use with column shift steering)	-	-	-	-	1	

232 Transmission

SERVICE PARTS LIST--PACKARD SUPER-EIGHT AND TWELVE

Piece No.	Name	1500	1506	1603	1607	1707
		1501	1507	1604	1608	1708
		1502	1508	1605	No. Required	
7826	Screw 5/16-24 x 5/8 hex. hd.	8	8	8	8	7
5504	Lockwasher 5/16	8	8	8	8	8
196547	Transmission case cover gasket	1	1	1	1	1
219932	Transmission case inspection hole cover assy. .	1	1	1	1	1
5699	Screw 1/4-28 x 13/32 flat hd.	4	4	4	4	4
5396	Lockwasher 1/4 Countersunk (Shakeproof) ..	4	4	4	4	4
6006	Transmission case motor support insulator bracket stud--short 3/8	7	7	7	7	7
6106	Stud--long 3/8	1	1	1	1	1
107889	Transmission case oil hole plug	2	2	2	2	2
20075	Gasket 1-1/4 annular	2	2	2	2	2
201320	Transmission case plug (Use with cane shift steering)	1	1	1	1	1
234878	Transmission change speed lever	1	1	-	-	-
240384	Transmission change speed lever (Use with cane shift steering)	-	-	1	1	1
186781	Transmission change speed lever anti-rattle spring (Use with cane shift steering)	1	1	1	1	1
234877	Transmission change speed lever ball	1	1	-	-	-
324337	Transmission change speed lever ball (Use with cane shift steering)	-	-	1	1	1
196620	Transmission change speed lever cap (Use with cane shift steering)	1	1	1	1	1
186778	Transmission change speed lever cap felt (Use with cane shift steering)	1	1	1	1	1
186779	Transmission change speed lever cap retaining screw No. 10-24 x 3/8 oval hd. (Use with cane shift steering)	3	3	3	3	3
186780	Transmission change speed lever pivot pin (Use with cane shift steering)	1	1	1	1	1
5533	Transmission change speed lever and support assembly screw 5/16-24 x 5/8 flat hd. (Use with cane shift steering)	6	6	6	6	6
196619	Transmission change speed lever support (Use with cane shift steering)	1	1	1	1	1
219121	Transmission change speed lever support gasket (Use with cane shift steering)	1	1	1	1	1
197542	Transmission change speed lever support spring (Use with cane shift steering)	1	1	1	1	1
190984	Transmission change speed lever support spring washer (Use with cane shift steering)	1	1	1	1	1
4306	Cotter pin 1/8 x 1 (Use with cane shift steering)	1	1	1	1	1
210346	Transmission clutch shaft assembly (Use with cane shift steering)	1	1	1	1	1
242813	Transmission clutch shaft assembly (Use with column shift steering)	-	-	-	-	1
205454	Transmission clutch shaft bearing front	1	1	1	1	1
205784	Transmission clutch shaft bearing front spacer.	1	1	1	1	1
196611	Transmission clutch shaft bearing rear	1	1	1	1	1
215101	Transmission clutch shaft bearing rear cover ..	1	1	1	1	1

SERVICE PARTS LIST--PACKARD SUPER-EIGHT AND TWELVE

Transmission 233

Piece No.	Name	1500	1506	1603	1607	1707	
		1501	1507	1604	1608	1708	
		1502	1508	1605	No. Required		
196573	Transmission clutch shaft bearing rear cover gasket	1	1	1	1	1	
6105	Transmission clutch shaft bearing rear cover stud 5/16	7	7	7	7	7	
6335	Stud 5/16-24 x 1-13/32	1	1	1	1	1	
5504	Lockwasher 5/16	8	8	8	8	8	
7005	Nut 5/16-24	8	8	8	8	8	
201358	Transmission clutch shaft bearing rear oil thrower (.288 thick)	x	x	x	x	x	
201359	Oil thrower (.230 thick)	x	x	x	x	x	
201360	Oil thrower (.232 thick)	x	x	x	x	x	
201361	Oil thrower (.234 thick)	x	x	x	x	x	
201362	Oil thrower (.236 thick)	x	x	x	x	x	
201363	Oil thrower (.238 thick)	x	x	x	x	x	
201364	Oil thrower (.240 thick)	x	x	x	x	x	
201365	Oil thrower (.242 thick)	x	x	x	x	x	
201366	Oil thrower (.244 thick)	x	x	x	x	x	
201367	Oil thrower (.246 thick)	x	x	x	x	x	
201368	Oil thrower (.248 thick)	x	x	x	x	x	
201369	Oil thrower (.250 thick)	x	x	x	x	x	
201370	Oil thrower (.252 thick)	x	x	x	x	x	
201371	Oil thrower (.254 thick)	x	x	x	x	x	
201372	Oil thrower (.256 thick)	x	x	x	x	x	
201354	Oil thrower (.220 thick)	x	x	x	x	x	
201355	Oil thrower (.222 thick)	x	x	x	x	x	
201356	Oil thrower (.224 thick)	x	x	x	x	x	
201357	Oil thrower (.226 thick)	x	x	x	x	x	
196675	Transmission clutch shaft bearing rear retaining ring (.086)	x	x	x	x	x	
196676	Retaining ring (.088)	x	x	x	x	x	
196677	Retaining ring (.090)	x	x	x	x	x	
196681	Retaining ring (.092)	x	x	x	x	x	
196612	Retaining ring (.094)	x	x	x	x	x	
196680	Retaining ring (.096)	x	x	x	x	x	
196679	Retaining ring (.098)	x	x	x	x	x	
196678	Retaining ring (.100)	x	x	x	x	x	
196696	Transmission clutch shaft bearing rear and ring assembly	1	1	1	1	1	
195879	Transmission clutch shaft bearing rear retaining nut (left hand thread)	1	1	1	1	1	
209194	Transmission clutch shifter lever (Use with cane shift steering)	1	1	1	1	1	
242842	Transmission clutch shifter lever (Use with column shift steering)	-	-	-	-	1	
196610	Transmission clutch shifter lever spring	1	1	1	1	1	
190245	Transmission clutch shifter lever spring retainer	1	1	1	1	1	
4310	Cotter pin 1/8 x 1-1/2	1	1	1	1	1	
209196	Transmission clutch shifter lever trunion ball	2	2	2	2	2	
209197	Transmission clutch shifter lever trunion oil seal	1	1	1	1	1	

Piece No.	Name	1500	1506	1603	1607	1707	
		1501	1507	1604	1608	1708	
		1502	1508	1605	No. Required		
209198	Transmission clutch shifter lever trunnion oil seal retainer	1	1	1	1	1	
209199	Transmission clutch shifter lever trunnion pin	1	1	1	1	1	
209200	Transmission clutch shifter lever trunnion retainer	1	1	1	1	1	
209201	Transmission clutch shifter lever trunnion roller	18	18	18	18	18	
230328	Transmission clutch shifter thrust bearing	1	1	1	1	1	
4559	Transmission clutch shifter thrust bearing oil plug 1/8 headless pipe plug	1	1	1	1	1	
215040	Transmission clutch shifter thrust bearing sleeve assembly	1	1	1	1	1	
144891	Transmission clutch shifter thrust bearing sleeve collar spring	2	2	2	2	2	
5397	Rivet (1/8 x 5/8 Countersunk hd.)	2	2	2	2	2	
210310	Transmission countershaft	1	1	1	1	1	
201328	Transmission countershaft bearing front	1	1	1	1	1	
201381	Transmission countershaft bearing rear	1	1	1	1	1	
201329	Transmission countershaft bearing front retaining ring (.0937)	x	x	x	x	x	
201330	Retaining ring (.0947)	x	x	x	x	x	
201331	Retaining ring (.0957)	x	x	x	x	x	
201332	Retaining ring (.0967)	x	x	x	x	x	
201353	Transmission countershaft bearing rear spacer	1	1	1	1	1	
201302	Transmission countershaft bushing	1	1	1	1	1	
210334	Transmission countershaft bushing gasket	1	1	1	1	1	
210323	Transmission countershaft gear cluster	1	1	1	1	1	
210305	Transmission countershaft lock	x	x	x	x	x	
210306	Transmission countershaft lock	x	x	x	x	x	
210307	Transmission countershaft lock	x	x	x	x	x	
210308	Transmission countershaft lock	x	x	x	x	x	
127273	Transmission countershaft nut front	1	1	1	1	1	
4320	Cotter pin 5/32 x 1-1/8	1	1	1	1	1	
201317	Transmission countershaft nut front washer (Special)	1	1	1	1	1	
7108	Transmission countershaft nut rear 1/2-20 castle	1	1	1	1	1	
4291	Cotter pin 3/32 x 3/4	1	1	1	1	1	
242778	Transmission direct drive and second speed gear shifter arm and shoe assembly--left (Use with column shift steering)	-	-	-	-	1	
242779	Transmission direct drive and second speed gear shifter arm and shoe assembly--right (Use with column shift steering)	-	-	-	-	1	
242773	Transmission direct drive and second speed gear shifter arm shoe (Use with column shift steering)	-	-	-	-	2	
3868	Washer (Use with column shift steering) ..	-	-	-	-	2	

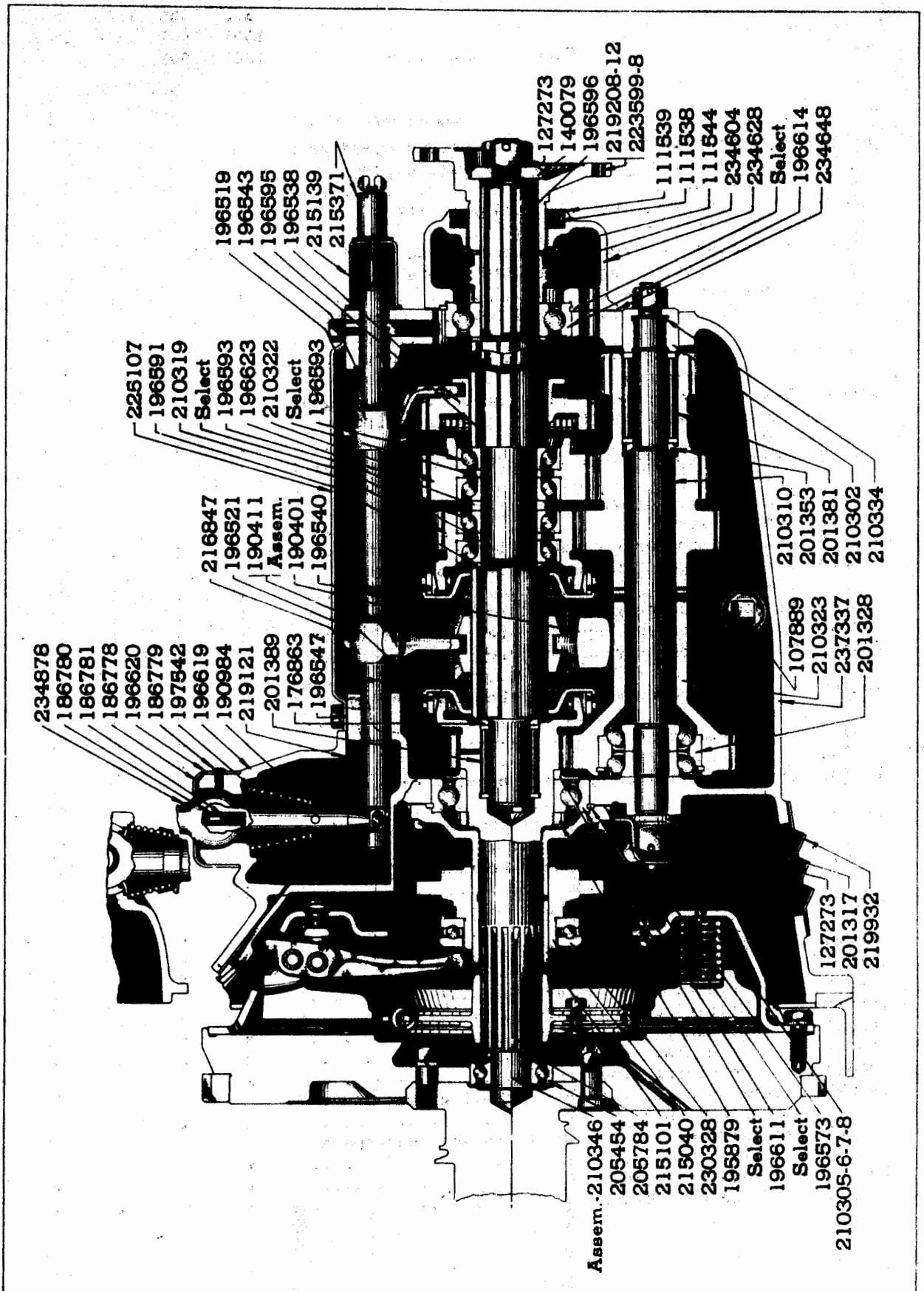

Models 1500-1-2-6-7-8

Piece No.	Name	1500	1506	1603	1607	1707
		1501	1507	1604	1608	1708
		1502	1508	1605	No. Required	
300313	Transmission direct drive and second speed gear shifter arm lock screw (Use with column shift steering).....	-	-	-	-	2
120813	Lock wire (Use with column shift steering)	-	-	-	-	2
196521	Transmission direct drive and second speed gear shifter fork (Use with cane shift steering)	1	1	1	1	1
5762	Screw 5/16-24 x 1-3/8 hex. hd. (Use with cane shift steering)	1	1	1	1	1
5504	Lockwasher 5/16 (Use with cane shift steering)	1	1	1	1	1
216847	Transmission direct drive and second speed gear shifter fork shaft (Use with cane shift steering)	1	1	1	1	1
196596	Transmission driving shaft (Use with cane shift steering)	1	1	1	1	1
242840	Transmission driving shaft (Use with column shift steering)	-	-	-	-	1
201389	Transmission driving shaft bearing front	1	1	1	1	1
176863	Transmission driving shaft bearing front spacer	1	1	1	1	1
196614	Transmission driving shaft bearing rear	1	1	1	1	1
234628	Transmission driving shaft bearing rear cover	1	1	1	1	1
234648	Transmission driving shaft bearing rear cover gasket	1	1	1	1	1
196551	Transmission driving shaft bearing rear cover stud	4	4	4	4	4
5506	Lockwasher 3/8	4	4	4	4	4
7006	Nut 3/8-24	4	4	4	4	4
111538	Transmission driving shaft bearing rear dust washer	1	1	1	1	1
111539	Transmission driving shaft bearing rear dust washer retainer	1	1	1	1	1
111544	Transmission driving shaft bearing rear oil thrower	1	1	1	1	1
196682	Transmission driving shaft bearing rear retaining ring (.086)	x	x	x	x	x
196683	Retaining ring (.088)	x	x	x	x	x
196684	Retaining ring (.090)	x	x	x	x	x
196685	Retaining ring (.092)	x	x	x	x	x
196615	Retaining ring (.094)	x	x	x	x	x
196686	Retaining ring (.096)	x	x	x	x	x
196687	Retaining ring (.098)	x	x	x	x	x
196688	Retaining ring (.100)	x	x	x	x	x
196699	Transmission driving shaft bearing rear and ring assembly	x	x	-	-	-
191513	Transmission driving shaft bearing rear spacer (.0725 thick)	x	x	x	x	x
191514	Spacer (.0745)	x	x	x	x	x
191515	Spacer (.0765)	x	x	x	x	x

SERVICE PARTS LIST--PACKARD SUPER-EIGHT AND TWELVE

Transmission 237

Piece No.	Name	1500	1506	1603	1607	1707	
		1501	1507	1604	1608	1708	
		1502	1508	1605	No. Required		
191516	Spacer (.0785)	x	x	x	x	x	
196582	Spacer (.0805)	x	x	x	x	x	
196583	Spacer (.0825)	x	x	x	x	x	
196584	Spacer (.0845)	x	x	x	x	x	
196585	Spacer (.0865)	x	x	x	x	x	
196586	Spacer (.0885)	x	x	x	x	x	
196587	Spacer (.0905)	x	x	x	x	x	
196588	Spacer (.0925)	x	x	x	x	x	
196589	Spacer (.0945)	x	x	x	x	x	
196590	Spacer (.0965)	x	x	x	x	x	
196689	Spacer (.0985)	x	x	x	x	x	
196690	Spacer (.1005)	x	x	x	x	x	
196691	Spacer (.1025)	x	x	x	x	x	
196692	Spacer (.1045)	x	x	x	x	x	
196693	Spacer (.1065)	x	x	x	x	x	
196694	Spacer (.1085)	x	x	x	x	x	
196695	Spacer (.1105)	x	x	x	x	x	
190401	Transmission driving shaft direct drive and second speed clutch gear (Use with cane shift steering)	1	1	1	1	1	
242780	Transmission driving shaft direct drive and second speed clutch gear (Use with column shift steering)	-	-	-	-	1	
210322	Transmission driving shaft first speed gear	1	1	1	1	1	
210340	Transmission driving shaft first speed gear and bearing assembly	1	1	1	1	1	
196593	Transmission driving shaft first speed gear bearing	2	2	2	2	2	
196592	Transmission driving shaft first speed gear bearing spacer (.1875)	x	x	x	x	x	
201373	Spacer (.1885)	x	x	x	x	x	
201374	Spacer (.1895)	x	x	x	x	x	
196538	Transmission driving shaft first speed and reverse clutch gear	1	1	1	1	1	
210319	Transmission driving shaft second speed gear (Use with cane shift steering)	1	1	1	1	1	
242770	Transmission driving shaft second speed gear (Use with column shift steering)	-	-	-	-	1	
196593	Transmission driving shaft second speed gear bearing	2	2	2	2	2	
201373	Transmission driving shaft second speed gear bearing spacer (.1885)	x	x	x	x	x	
196592	Spacer (.1875)	x	x	x	x	x	
201374	Spacer (.1895)	x	x	x	x	x	
196623	Transmission driving shaft second and first speed gear bearing spacer	1	1	1	1	1	
196591	Transmission driving shaft and second speed gear bearing spacer	1	1	1	1	1	
196595	Transmission driving shaft sleeve	1	1	1	1	1	
219208	Transmission driving shaft universal joint flange	-	1	-	1	1	

Piece No.	Name	1500	1506	1603	1607	1707
		1501	1507	1604	1608	1708
		1502	1508	1605	No. Required	
223599	Transmission driving shaft universal joint flange	1	-	1	-	-
4320	Cotter pin 5/32 x 1-1/8	1	1	1	1	1
127273	Transmission driving shaft universal joint flange nut	1	1	1	1	1
140079	Transmission driving shaft universal joint flange washer	1	1	1	1	1
242784	Transmission first speed and reverse gear shifter arm left (Use with column shift steering)	-	-	-	-	1
242785	Transmission first speed and reverse gear shifter arm right (Use with column shift steering)	-	-	-	-	1
300313	Lock screw (Use with column shift steering)	-	-	-	-	2
120813	Lock wire (Use with column shift steering)	-	-	-	-	2
196519	Transmission first speed and reverse gear shifter fork (Use with cane shift steering)	1	1	1	1	1
5762	Screw 5/16-24 x 1-3/8 hex. hd. (Use with cane shift steering)	1	1	1	1	1
5504	Lockwasher 5/16 (Use with cane shift steering)	1	1	1	1	1
196543	Transmission first speed and reverse gear shifter fork shaft (Use with cane shift steering)	1	1	1	1	1
242782	Transmission first speed and reverse gear shifter yoke (Use with column shift steering)	-	-	-	-	1
5761	Transmission gear shifter shaft interlocking ball 1/2 diameter (Use with cane shift steering)	1	1	1	1	1
215139	Transmission gear shifter shaft stop cover (Use with cane shift steering)	1	1	1	1	1
196558	Transmission gear shifter shaft stop cover gasket (Use with cane shift steering)	1	1	1	1	1
196527	Transmission gear shifter shaft stop cover screw 5/16-24 x 2-5/16 mach. (Use with cane shift steering)	2	2	2	2	2
5504	Lockwasher 5/16 (Use with cane shift steering)	2	2	2	2	2
196520	Transmission reversing pinion	1	1	1	1	1
196552	Transmission reversing pinion bushing	1	1	1	1	1
196556	Transmission reversing pinion pin	1	1	1	1	1
196526	Transmission reversing pinion pin lock screw ..	1	1	1	1	1
179531	Transmission reversing pinion pin lock screw gasket	1	1	1	1	1
5079	Transmission shifter forks detent ball 5/16 (Use with column shift steering)	-	-	-	-	1
330235	Transmission shifter forks detent ball spring (Use with column shift steering)	-	-	-	-	1
242793	Transmission shifter forks interlock bracket (Use with column shift steering)	-	-	-	-	1
242789	Screw 5/16-24 x 2-5/16 hex. hd. (Use with column shift steering)	-	-	-	-	2

SERVICE PARTS LIST--PACKARD SUPER-EIGHT AND TWELVE

Transmission 239

Piece No.	Name	1500	1506	1603	1607	1707	
		1501	1507	1604	1608	1708	
		1502	1508	1605	No. Required		
7105	Nut 5/16-24 castle (Use with column shift steering)	-	-	-	-	2	
4280	Cotter pin 1/16 x 1/2 (Use with column shift steering)	-	-	-	-	2	
5079	Transmission shifter fork interlock ball 5/16 (Use with column shift steering)	-	-	-	-	2	
335126	Transmission shifter fork interlock ball spacer (Use with column shift steering)	-	-	-	-	1	
242768	Transmission shifter fork shaft (Use with column shift steering)	-	-	-	-	2	
5034	Transmission shifter fork shaft lock ball 3/8 diameter (Use with cane shift steering)	2	2	2	2	2	
196530	Transmission shifter fork shaft lock ball spring (Use with cane shift steering)	2	2	2	2	2	
103871	Transmission shifter fork shaft lock expansion plug (9/16) (Use with cane shift steering) ..	1	1	1	1	1	
234604	Transmission speedometer driving gear (18-6 speedometer ratio) (4.69-1 rear axle ratio) (Standard for 1500-1-2-1603-4-5) (Special for 1506-7-8-1607-8-1707-8)	1	1	1	1	1	
234605	Transmission speedometer driving gear (17-6 speedometer ratio) (4.36-1 rear axle ratio) (Special)	1	-	1	-	-	
237655	Transmission speedometer driving gear (16-5 speedometer ratio) (4.9 to 1 rear axle ratio) (Special)	1	-	1	-	-	
237885	Transmission speedometer driving gear (22-8 speedometer ratio) (4.41-1 rear axle ratio) (Standard)	-	1	-	1	1	
234603	Transmission speedometer driving gear (26-10 speedometer ratio) (4.06 to 1 rear axle ratio) (Special)	-	1	-	1	1	
242805	Transmission synchronizer assembly (Use with column shift steering)	-	-	-	-	1	
237128	Transmission speedometer pinion and shaft assembly (18-6 speedometer ratio) (4.69 to 1 rear axle ratio) (Standard for 1500-1501-1502-1603-4-5 and Special for 1506-1707-1508-1607-1608-1707-1708)	1	1	1	1	1	
316278	Transmission speedometer pinion and shaft assembly (17-6 speedometer ratio) (4.36 to 1 rear axle ratio) (Special)	1	-	1	-	-	
237667	Transmission speedometer pinion and shaft assembly (16-5 speedometer ratio) (4.9 to 1 rear axle ratio) (Special)	1	-	1	-	-	
237886	Transmission speedometer pinion and shaft assembly (4.41 to 1 rear axle ratio) (Standard)	-	1	-	1	1	
237129	Transmission speedometer pinion and shaft assembly (26-10 speedometer ratio) (4.06 to 1 rear axle ratio) (Special)	-	1	-	1	1	

Piece No.	Name	1500	1506	1603	1607	1707	
		1501	1507	1604	1608	1708	
		1502	1508	1605	No. Required		
300536	Transmission speedometer pinion shaft bearing .	1	1	1	1	1	
190411	Transmission synchronizer brake and housing assembly (Use with cane shift steering)	2	2	2	2	2	
190441	Transmission synchronizer connecting link (Use with cane shift steering)	2	2	2	2	2	
242791	Transmission synchronizer detent spring (Use with column shift steering)	-	-	-	-	3	
186625	Transmission synchronizer plunger assembly (Use with cane shift steering)	2	2	2	2	2	
196540	Transmission synchronizer yoke (Use with cane shift steering)	1	1	1	1	1	
186611	Transmission synchronizer yoke centralizing spring (Use with cane shift steering)	2	2	2	2	2	
186615	Transmission synchronizer yoke centralizing spring cap (Use with cane shift steering) ...	2	2	2	2	2	
4294	Cotter pin 3/32 x 1-1/8 (Use with cane shift steering)	2	2	2	2	2	
196621	Transmission synchronizer yoke centralizing spring screw (Use with cane shift steering) .	1	1	1	1	1	
5508	Lockwasher 7/16 (Use with cane shift steering)	1	1	1	1	1	
186838	Transmission synchronizer yoke pin (Use with cane shift steering)	2	2	2	2	2	
191507	Transmission synchronizer yoke pin retaining ring (Use with cane shift steering)	2	2	2	2	2	
190423	Transmission synchronizer yoke pivot pin (Use with cane shift steering)	2	2	2	2	2	
191562	Transmission synchronizer yoke pivot pin packing (Use with cane shift steering)	2	2	2	2	2	
191561	Transmission synchronizer yoke pivot pin packing housing (Use with cane shift steering) ..	2	2	2	2	2	
191505	Transmission synchronizer yoke pivot pin retaining clip (Use with cane shift steering)	2	2	2	2	2	
5687	Screw 1/4-28 x 5/8 fill. hd. (Use with cane shift steering)	2	2	2	2	2	
5502	Lockwasher 1/4 std. (Use with cane shift steering)	2	2	2	2	2	

TRUNK RACK

Specify color on all painted Trunk Rack parts

0239070	Trunk rack equipment (Used on 1003-12-13-14-15-1063)	1	-	-	-	-
0242193	Trunk rack equipment (Used on 1103-12-13-14-15-1143)	-	-	1	-	-
0239071	Trunk rack equipment (Used on 1018-1019)	1	-	-	-	-
0242195	Trunk rack equipment (Used on 1118-1119)	-	-	1	-	-
0239072	Trunk rack equipment (Used on 1016-1017-1007) .	1	-	-	-	-
0242196	Trunk rack equipment (Used on 1116-1117-1107) .	-	-	1	-	-

239623 9/08
237624

10/19/1938 37 C/CC

239627 CASTING
239628 CASTING
1603?

SERVICE PARTS LIST--PACKARD SUPER-EIGHT AND TWELVE Trunk Rack 241

Piece No.	Name	1500	1506	1603	1607	1707	
		1501	1507	1604	1608	1708	
		1502	1508	1605	No. Required		
0239073	Trunk rack equipment (Used on 1023-32-33-34-35-1073)	-	1	-	-	-	
0242194	Trunk rack equipment (Used on 1132-33-34-35-1153-1232-33-34-35-1253)	-	-	-	1	1	
0239074	Trunk rack equipment (Used on 1027-1036-1037)	-	1	-	-	-	
0242197	Trunk rack equipment (Used on 1127-1136-1137-1227-1236-1237)	-	-	-	1	1	
0239075	Trunk rack equipment (Used on 1038-1039)	-	1	-	-	-	
0242198	Trunk rack equipment (Used on 1138-1139-1238-1239)	-	-	-	1	1	
223532	Trunk rack assembly (Specify color)	-	1	-	-	-	
239622	Trunk rack assembly (Specify color)	-	-	-	1	1	
230126	Trunk rack assembly (Specify color)	1	-	-	-	-	
239621	Trunk rack assembly (Specify color)	-	-	1	-	-	
194251	Trunk rack brace joint assembly	2	2	2	2	2	
234809	Trunk rack bracket assembly--left (Specify color) (Use with bodies 1012-1032-1003-1013-14-15-1023-1033-34-35-1063-1073) ^{SEPARATE}	1	1	-	-	-	
234813	Trunk rack bracket assembly--left (Specify color) (Use with bodies 1018-19-1038-39) ^{1937 COUPE/CONV. COUPE}	1	1	-	-	-	
234811	Trunk rack bracket assembly--left (Specify color) (Use with bodies 1016-17-1036-37-1007-1027) ^{1937 VICT. COUPE/CONV. COUPE}	1	1	-	-	-	
234810	Trunk rack bracket assembly--right (Specify color) (Use with bodies 1012-13-14-15-1032-33-34-35-1003-1023-1063-1073)	1	1	-	-	-	
234814	Trunk rack bracket assembly--right (Specify color) (Use with bodies 1018-19-1038-39)	1	1	-	-	-	
234812	Trunk rack bracket assembly--right (Specify color) (Use with bodies 1016-17-1036-37-1007-1027)	1	1	-	-	-	
239629	Trunk rack bracket assembly--left (Use with bodies 1103-1112-13-14-15-1132-33-34-35-43-53-1232-33-34-35-53) ^{38-39 SEPARATE}	-	-	1	1	1	
239633	Trunk rack bracket assembly--left (Use with bodies 1118-19-38-39-1238-39) ^{1937 COUPE/CONV. COUPE}	-	-	1	1	1	
239631	Trunk rack bracket assembly--left (Use with bodies 1116-17-36-37-1107-27-1236-37-27)	-	-	1	1	1	
239630	Trunk rack bracket assembly--right (Use with bodies 1103-12-13-14-15-1132-33-34-35-43-53-1232-33-34-35-53)	-	-	1	1	1	
239634	Trunk rack bracket assembly--right (Use with bodies 1118-1119-38-39-1238-39)	-	-	1	1	1	
239632	Trunk rack bracket assembly--right (Use with bodies 1116-17-1136-37-1107-27-1236-37-27) ..	-	-	1	1	1	
223507	Trunk rack bracket pivot pin	2	2	2	2	2	
239620	Trunk rack bracket pivot pin long bushing	-	-	2	2	2	
223512	Trunk rack bracket pivot pin shim	x	x	-	-	-	
239656	Trunk rack bracket pivot pin shim	-	-	x	x	x	
5665	Trunk rack bracket pivot pin nut 5/16-24 blind.	2	2	2	2	2	
5504	Lockwasher 5/16	2	2	2	2	2	

9/08 New
234804
803

1937 COUPE/CONV. COUPE
234803, 234804
234807 1938/1939
234808 CONV./COUPE
CONV. VICT.
(GILMORE CAS)
Also 27 1/2 coupe!

Piece No.	Name	1500	1506	1603	1607	1707	
		1501	1507	1604	1608	1708	
		1502	1508	1605	No. Required		
3874	Washer 5/16	2	2	2	2	2	
303463	Trunk rack bracket screw	4	4	4	4	4	
6045	Lockwasher 7/16 (Shakeproof)	4	4	4	4	4	
237627	Trunk rack to bracket lock plunger	2	2	2	2	2	
237626	Trunk rack to bracket lock plunger knob	2	2	2	2	2	
300693	Trunk rack to bracket lock plunger to knob pin.	2	2	2	2	2	
230007	Trunk rack to bracket lock plunger seat	2	2	2	2	2	
237625	Trunk rack to bracket lock plunger spring	2	2	2	2	2	
213013	Trunk rack emblem	1	-	1	-	-	
203166	Trunk rack emblem	-	1	-	1	1	
5447	Lockwasher 1/4 (Shakeproof)	-	1	-	-	-	
5502	Lockwasher 1/4 (Standard)	-	-	-	2	2	
5500	Lockwasher No. 10	2	-	2	-	-	
7003	Trunk rack emblem nut No. 10-32	2	-	2	-	-	
239617	Trunk rack emblem nut	-	-	-	2	2	
209963	Trunk rack emblem mounting plate	-	1	-	1	1	
223505	Trunk rack pivot pin--short	2	2	2	2	2	
223506	Trunk rack pivot pin--long	2	2	-	-	-	
239619	Trunk rack pivot pin--long	-	-	2	2	2	
5665	Trunk rack pivot pin nut 5/16-24 blind	4	4	4	4	4	
5504	Lockwasher 5/16	4	4	4	4	4	
3874	Washer 5/16	4	4	4	4	4	
191403	Trunk rack trim stick--upper	-	1	-	1	1	
230124	Trunk rack trim strip--upper	1	-	1	-	-	
230125	Trunk rack trim strip--lower	4	-	4	-	-	
191404	Trunk rack trim stick--lower	-	4	-	4	4	
303270	Trunk rack trim strip clip	20	-	20	-	-	
6373	Trunk rack trim stick screw 1/4-20 x 3/8 rnd. hd.	-	20	-	20	20	

UNIVERSAL JOINT

221670	Universal joint shaft assembly (Used on 1500-1603)	1	-	1	-	-
221671	Universal joint shaft assembly (Used on 1501-1604)	1	-	1	-	-
221672	Universal joint shaft assembly (Used on 1502-1605)	1	-	1	-	-
221676	Universal joint shaft assembly (Used on 1506) .	-	1	-	-	-
221677	Universal joint shaft assembly (Used on 1507-1607-1707)	-	1	-	1	1
221678	Universal joint shaft assembly (Used on 1508-1608-1708)	-	1	-	1	1
242247	Universal joint shaft assembly bolt	8	-	8	-	-
140065	Universal joint shaft assembly bolt	-	12	-	12	12
7007	Nut 7/16-20	8	-	8	-	-
7005	Nut 5/16-24	-	12	-	12	12
5508	Lockwasher 7/16	8	-	8	-	-
5504	Lockwasher 5/16	-	12	-	12	12
0228645	Universal joint assembly--front	1	-	1	-	-

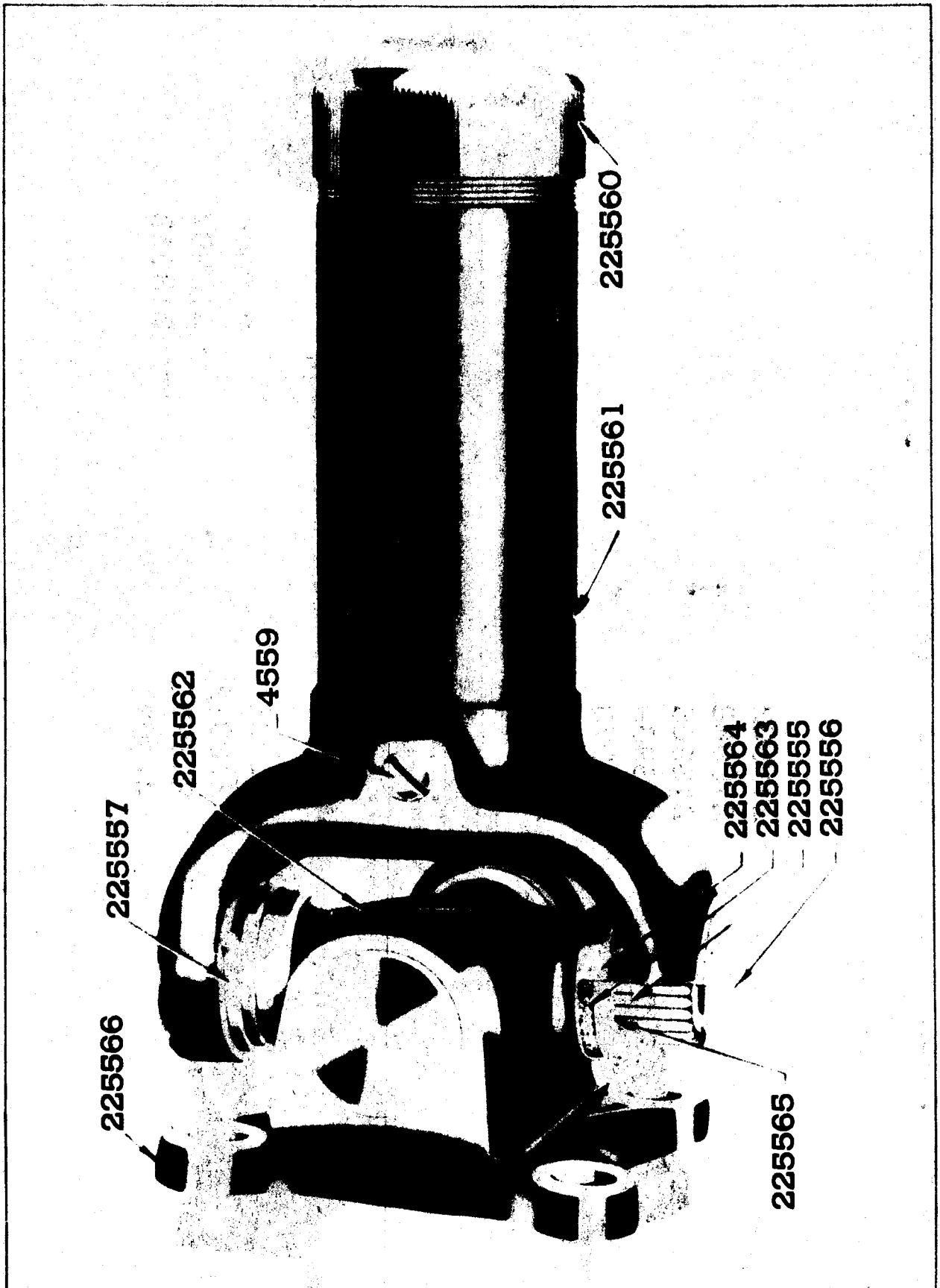

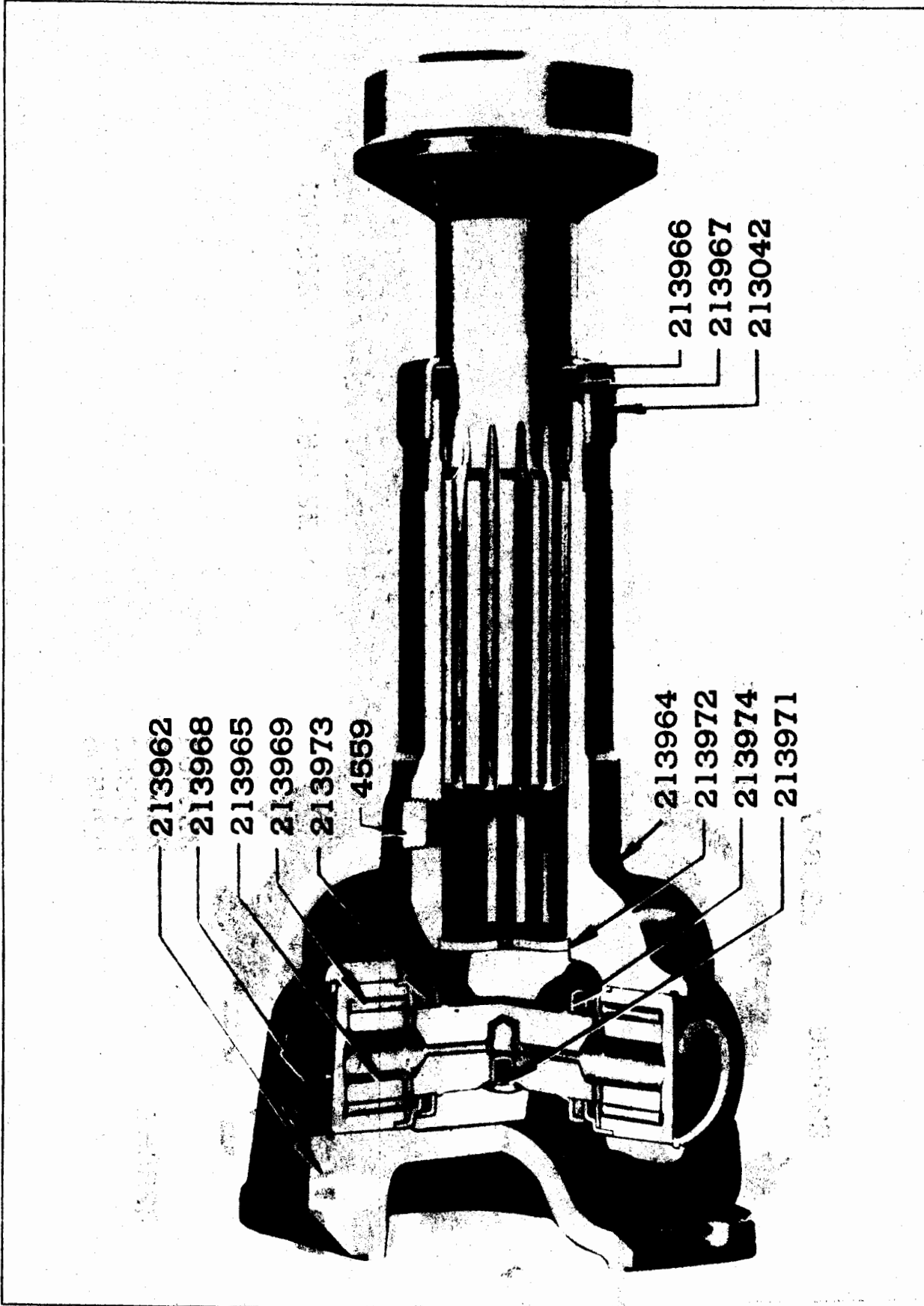

Models 1506-7-8, 1607-8, 1707-8

SERVICE PARTS LIST--PACKARD SUPER-EIGHT AND TWELVE

Wheels 245

Piece No.	Name	1500	1506	1603	1607	1707	
		1501	1507	1604	1608	1708	
		1502	1508	1605	No. Required		
0225566	Universal joint companion flange	2	-	2	-	-	
0225562	Universal joint cross assembly	2	-	2	-	-	
0225564	Universal joint dust excluder	8	-	8	-	-	
0213962	Universal joint flange yoke	-	2	-	2	2	
0213968	Universal joint journal snap ring	-	8	-	8	8	
0213969	Universal joint needle bearing assembly	-	8	-	8	8	
4559	Universal joint oil hole plug	-	1	-	1	1	
0225555	Universal joint roller bearing assembly	8	-	8	-	-	
0225556	Universal joint roller bushing	8	-	8	-	-	
0225563	Universal joint roller bushing cork	8	-	8	-	-	
0225557	Universal joint roller bushing retainer	8	-	8	-	-	
0225565	Universal joint roller retainer	8	-	8	-	-	
0225552	Universal joint shaft (Used on 1500-1603)	1	-	1	-	-	
0225553	Universal joint shaft (Used on 1501-1604)	1	-	1	-	-	
0225554	Universal joint shaft (Used on 1502-1605)	1	-	1	-	-	
0225539	Universal joint shaft (Used on 1506)	-	1	-	-	-	
0225540	Universal joint shaft (Used on 1507-1607-1707)	-	1	-	1	1	
0225541	Universal joint shaft (Used on 1508-1608-1708)	-	1	-	1	1	
0213965	Universal joint sleeve journal assembly	-	2	-	2	2	
0213973	Universal joint sleeve journal gasket	-	8	-	8	8	
0213974	Universal joint sleeve journal gasket retainer	-	8	-	8	8	
0213970	Universal joint sleeve nipple	-	2	-	2	2	
0213971	Universal joint sleeve relief valve	-	2	-	2	2	
0213966	Universal joint sleeve washer	-	1	-	1	1	
0213967	Universal joint sleeve washer (cork)	-	1	-	1	1	
0225561	Universal joint sleeve yoke assembly	1	-	1	-	-	
0213964	Universal joint sleeve yoke assembly	-	1	-	1	1	
0213972	Universal joint sleeve yoke plug	-	1	-	1	1	
0225560	Universal joint spline dust cap	1	-	1	-	-	
4559	Universal joint spline grease plug	1	-	-	-	-	
0225558	Universal joint spline washer--felt (plain) ...	1	-	1	-	-	
0225559	Universal joint spline washer--steel (plain) ..	1	-	1	-	-	
0242372	Universal joint spline washer--steel (splined) ..	-	-	2	-	-	
0242373	Universal joint spline washer--felt (splined) ..	-	-	1	-	-	

WHEELS

(Specify Color and Striping on all orders for wheels)

234526	Wheel assembly--disc (16 x 5.00 rim)	5	-	5	-	-
237830	Wheel assembly (artillery type, stamped steel spokes)	5	-	5	-	-
234700	Wheel assembly--disc (16 x 6.00) (16 x 8.25 tire)	-	5	-	5	5
338811	Wheel bolt (10 required for bodies 1144-1145) (Supersedes 197382)	20	24	20	24	24
234839	Wheel brake drum dampener spring	4	-	4	-	-
216558	Wheel brake drum dampener spring	-	4	-	4	4
304815	Wheel brake drum inspection hole cover	4	-	4	-	-
209444	Wheel brake drum inspection hole cover	-	4	-	4	4
231217	Wheel hub cap front	2	2	2	2	2

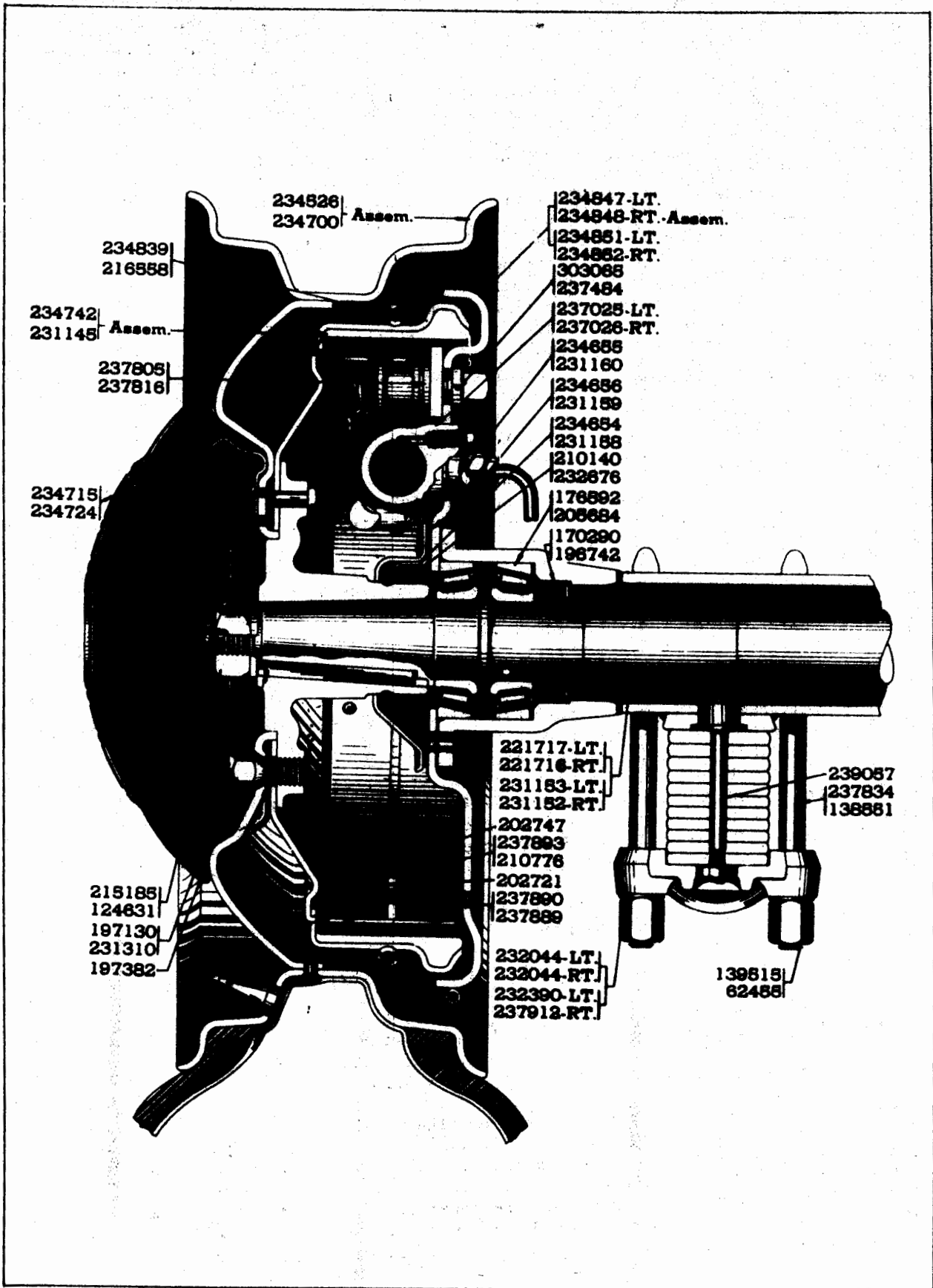

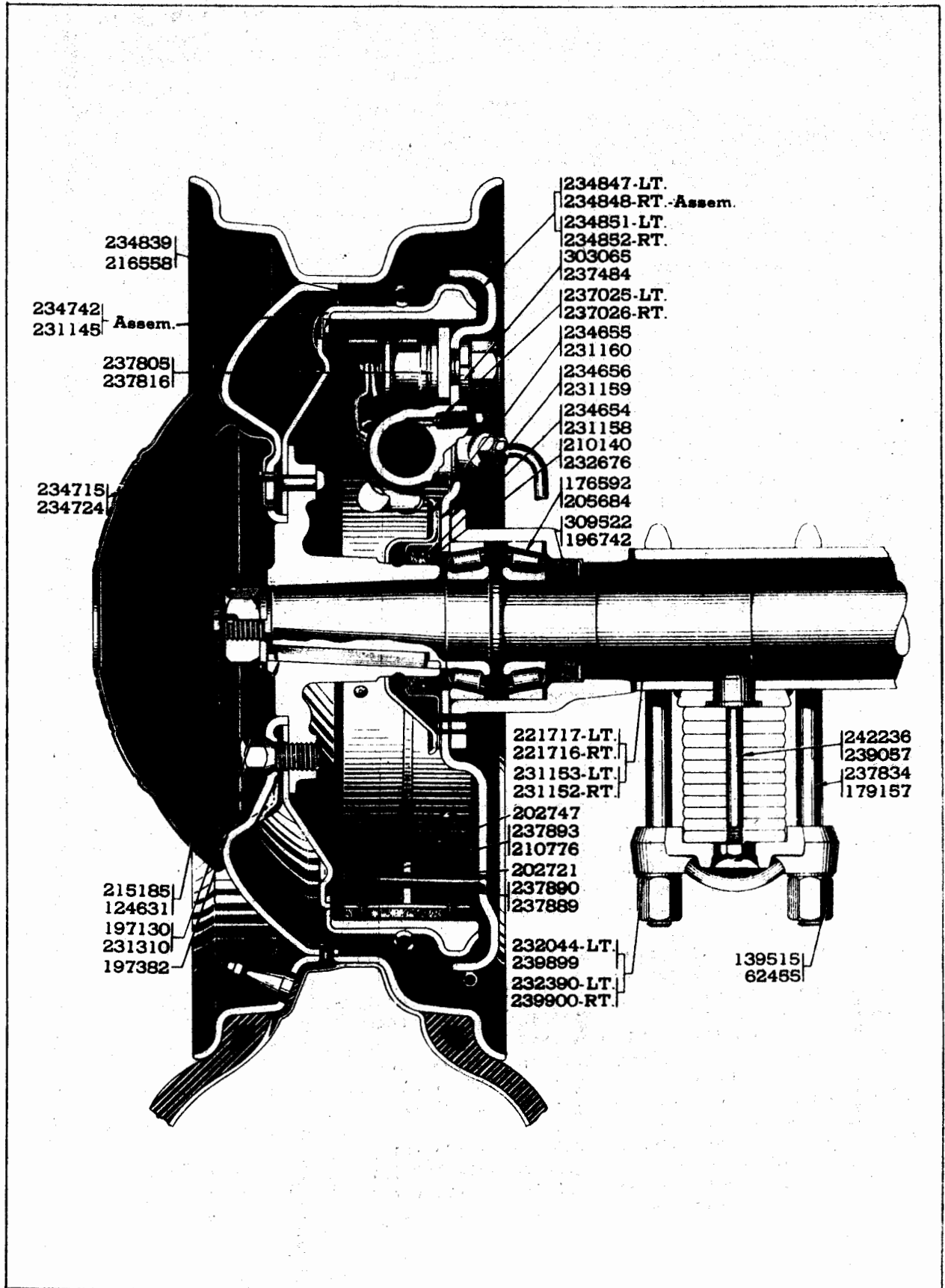

234839
216558

234742
231145 Assem.

237805
237816

234715
234724

215185
124631
197130
231310
197382

234847-LT.
234848-RT.-Assem.
234851-LT.
234852-RT.
303065
237484
237025-LT.
237026-RT.
234655
231160
234656
231159
234654
231158
210140
232676
176592
205684
309522
196742

221717-LT.
221716-RT.
231153-LT.
231152-RT.
202747
237893
210776
202721
237890
237889

232044-LT.
239899
232390-LT.
239900-RT.

242236
239057
237834
179157

139515
62455

Piece No.	Name	1500	1506	1603	1607	1707
		1501	1507	1604	1608	1708
		1502	1508	1605	No. Required	
234734	Wheel hub and drum assembly--front	2	-	2	-	-
237091	Wheel hub and drum assembly--front	-	2	-	2	2
234742	Wheel hub and drum assembly--rear	2	-	2	-	-
231145	Wheel hub and drum assembly--rear	-	2	-	2	2
237476	Wheel hub front oil seal	2	-	2	-	-
237477	Wheel hub front oil seal	-	2	-	2	2
234715	Wheel hub shell cover (Black)	4	-	4	-	-
234716	Wheel hub shell cover (Specify color) (Special paint)	4	-	4	-	-
234724	Wheel hub shell cover and emblem assembly (Black)	-	4	-	4	-
242427	Wheel hub shell cover and emblem assembly (Black)	-	-	-	-	4
234725	Wheel hub shell cover and emblem assembly (Specify color) (Special paint)	-	4	-	4	-
242559	Wheel hub shell cover and emblem assembly (Specify color) (Special paint)	-	-	-	-	4
234801	Wheel hub shell cover emblem	-	4	-	4	4
5502	Lockwasher 1/4	-	4	-	4	4
239617	Nut	-	4	-	4	4
0239476	Wheel hub shell cover retaining clip	20	-	20	-	-
0239601	Wheel hub shell cover retaining clip	-	20	-	20	20
4152	Rivet	20	-	20	20	20
231391	Wheel trim ring	-	5	-	5	5

WHEEL SUSPENSION FRONT

237965	Wheel (front) jack bracket	2	-	2	-	-
239773	Wheel (front) jack bracket--left (Supersedes 237450)	-	1	-	1	1
239774	Wheel (front) jack bracket--right (Supersedes 237451)	-	1	-	1	1
232561	Wheel (front) spring (1750 lbs. x 90 rate) (Use on 1500-1603)	2	-	2	-	-
237559	Wheel (front) spring (1925 lbs. x 105 rate) (Side wheel carrier) (Use on 1500-1501-1603- 1604)	2	-	2	-	-
237854	Wheel (front) spring (Used on bodies 1144-1145) (Side wheel carrier)	-	-	2	-	-
237853	Wheel (front) spring (Used on bodies 1144-1145)	-	-	2	-	-
232480	Wheel (front) spring (1850 lbs. x 95 rate) (Use on 1501-1502-1604-1605)	2	-	2	-	-
237425	Wheel (front) spring (2025 lbs. x 105 rate) (Side wheel carrier) (Use on 1502-1605)	2	-	2	-	-
237905	Wheel (front) spring (2125 lbs. x 120 rate) (Use on 1506)	-	2	-	-	-
237686	Wheel (front) spring (2325 lbs. x 120 rate) (Side wheel carrier) (Use on 1506-1507)	-	2	-	-	-
237906	Wheel (front) spring (2225 lbs. x 120 rate) (Use on 1507-1508)	-	2	-	-	-

SERVICE PARTS LIST--SUPER-EIGHT AND TWELVE

Wheel Suspension Front 249

Piece No.	Name	1500	1506	1603	1607	1707	
		1501	1507	1604	1608	1708	
		1502	1508	1605	No. Required		
237686	Wheel (front) spring (2325 lbs. x 120 rate)....	-	-	-	2	2	
240293	Wheel (front) spring (2550 lbs. x 125 rate) (Side wheel carrier) (Used on 1608-1708)	-	-	-	2	2	
237907	Wheel (front) spring (2450 lbs. x 120 rate) (Side wheel carrier) (Use on 1508-1607- 1707)	-	2	-	2	2	
239106	Wheel (front) spring (2450 lbs. x 139 rate) (Hearse chassis only)	2	-	-	-	-	
237851	Wheel (front) spring (1750 lbs. x 130 rate) (Export) (Use with body 1003)	2	-	-	-	-	
237853	Wheel (front) spring (1850 lbs. x 130 rate) (Export) (Use with bodies 1007-12-13-14-15- 16-17-18-19-63)	2	-	-	-	-	
237852	Wheel (front) spring (1925 lbs. x 130 rate) (Export) (Side wheel carrier) (Use with bodies 1003-07-12-13-16-17-18-19)	2	-	-	-	-	
237854	Wheel (front) spring (2025 lbs. x 130 rate) (Export) (Side wheel carrier) (Use with bodies 1014-15-63)	2	-	-	-	-	
237855	Wheel (front) spring (2125 lbs. x 145 rate) (Export) (Use with body 1023)	-	2	-	-	-	
237857	Wheel (front) spring (2225 lbs. x 145 rate) (Export) (Use with bodies 1027-32-33-34-35- 36-37-38-39-73-L395)	-	2	-	-	-	
237858	Wheel (front) spring (2450 lbs. x 155 rate) (Export) (Side wheel carrier) (Use with bodies 1034-35-73-L395)	-	2	-	-	-	
237856	Wheel (front) spring (2325 lbs. x 150 rate) (Export) (Side wheel carrier) (Use with bodies 1023-27-32-33-36-37-38-39)	-	2	-	-	-	
234930	Wheel (front) spring bumper assembly	2	2	2	2	-	
333038	Wheel (front) spring bumper assembly	-	-	-	-	2	
7005	Nut 5/16-24	6	6	6	6	6	
5504	Lockwasher 5/16	6	6	6	6	6	
232014	Wheel (front) spring bumper seat	2	-	2	-	-	
232012	Wheel (front) spring bumper seat	-	2	-	2	-	
242405	Wheel (front) spring bumper seat	-	-	-	-	2	
300948	Wheel (front) spring bumper striker lower	2	-	2	-	-	
232004	Wheel (front) spring bumper striker lower	-	2	-	2	2	
300982	Wheel (front) spring insulator	4	-	4	-	-	
232010	Wheel (front) spring insulator	-	4	-	4	4	
237492	Wheel (front) spring rebound bumper assembly ..	2	-	2	-	-	
237096	Wheel (front) spring rebound bumper assembly ..	-	2	-	2	2	
7006	Nut 3/8-24	2	2	2	2	2	
5506	Lockwasher 3/8	2	2	2	2	2	
231186	Wheel (front) steering knuckle assembly	2	-	-	-	-	
240044	Wheel (front) steering knuckle assembly	-	-	2	-	-	
237090	Wheel (front) steering knuckle	-	2	-	2	2	
302721	Wheel (front) steering knuckle adjusting nut inner	2	-	2	-	-	

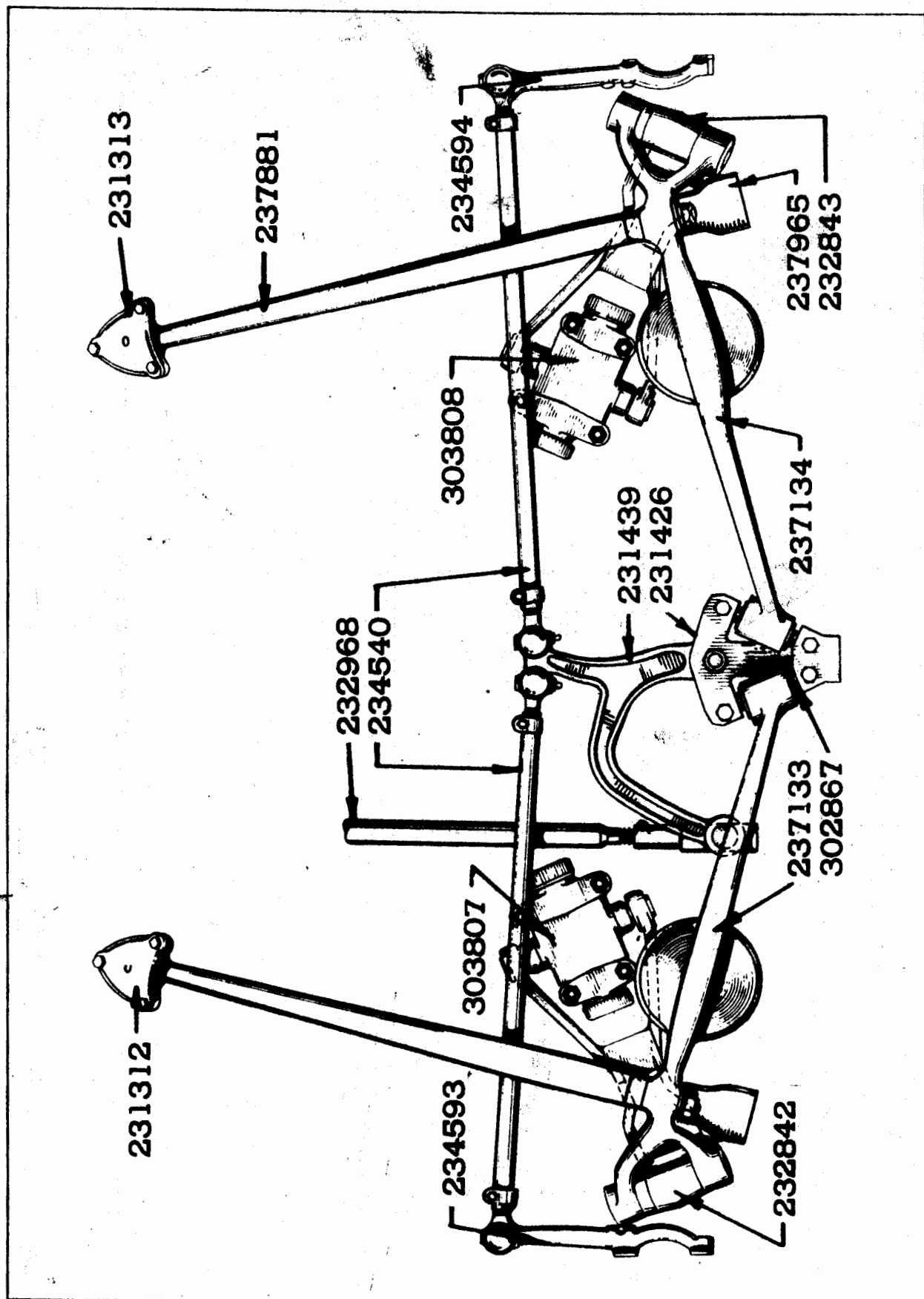

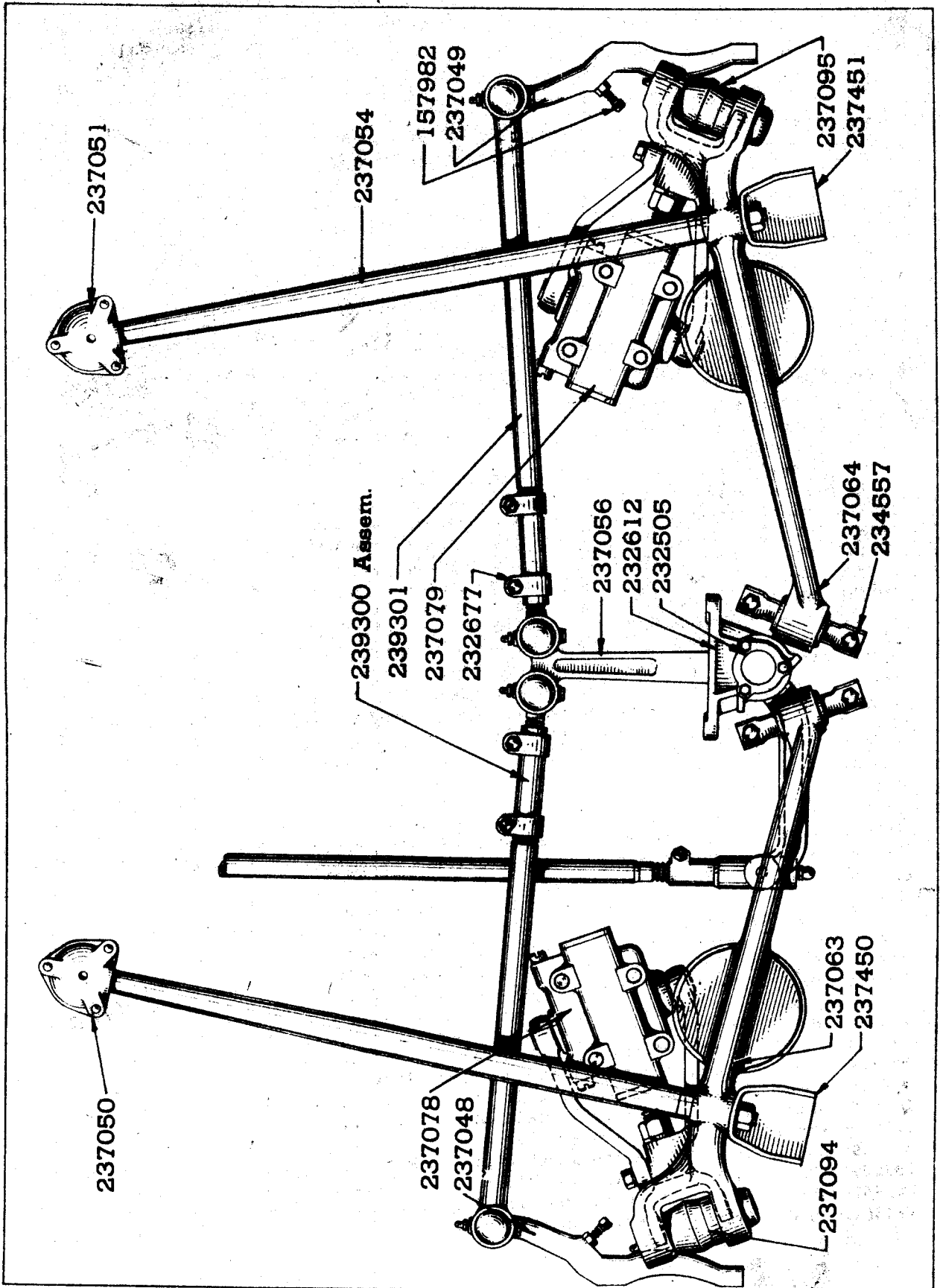

Models 1506-7-8

Piece No.	Name	1500	1506	1603	1607	1707	
		1501	1507	1604	1608	1708	
		1502	1508	1605	No. Required		
118228	Wheel (front) steering knuckle adjusting nut ..	-	4	-	4	4	
302684	Wheel (front) steering knuckle adjusting nut outer	2	-	2	-	-	
4308	Cotter pin 1/8 x 1-1/4	2	-	2	-	-	
4320	Cotter pin 5/32 x 1-1/8	-	2	-	2	2	
43293	Pin	2	2	2	2	2	
302720	Wheel (front) steering knuckle adjusting nut lockwasher	2	-	2	-	-	
118230	Wheel (front) steering knuckle adjusting nut lockwasher	-	2	-	2	2	
0176593	Wheel (front) steering knuckle bearing assembly-inboard	2	-	2	-	-	
0139769	Wheel (front) steering knuckle bearing assembly-inboard	-	2	-	2	2	
237615	Wheel (front) steering knuckle bearing inboard spacer	-	2	-	2	2	
097056	Wheel (front) steering knuckle bearing assembly-outboard	2	2	2	2	2	
300278	Wheel (front) steering knuckle bearing (thrust)	2	-	-	-	-	
240032	Wheel (front) steering knuckle bearing (thrust)	-	-	2	-	-	
237081	Wheel (front) steering knuckle bearing (thrust)	-	2	-	2	2	
311942	Wheel (front) steering knuckle bushing	4	-	-	-	-	
240031	Wheel (front) steering knuckle bushing	-	-	4	-	-	
234593	Wheel (front) steering knuckle lever--left	1	-	-	-	-	
240042	Wheel (front) steering knuckle lever--left	-	-	1	-	-	
237048	Wheel (front) steering knuckle lever--left	-	1	-	1	1	
234594	Wheel (front) steering knuckle lever--right ...	1	-	-	-	-	
240043	Wheel (front) steering knuckle lever--right ...	-	-	1	-	-	
237049	Wheel (front) steering knuckle lever--right ...	-	1	-	1	1	
234577	Screw--short	2	-	2	-	-	
234578	Screw--short	-	2	-	2	2	
234579	Screw--long	2	-	2	2	2	
234606	Screw--long	-	2	-	2	2	
180803	Wheel (front) steering knuckle lever stop screw	2	-	2	-	-	
157982	Wheel (front) steering knuckle lever stop screw	-	2	-	2	2	
7006	Nut 3/8-24	2	2	2	2	2	
232776	Wheel (front) steering knuckle oil guard and baffle assembly	2	-	2	-	-	
237104	Wheel (front) steering knuckle oil guard assy..	-	2	-	2	2	
237107	Wheel (front) steering knuckle oil guard felt .	-	2	-	2	2	
237108	Wheel (front) steering knuckle oil guard felt retainer	-	2	-	2	2	
216549	Wheel (front) steering knuckle oiler	2	2	-	-	-	
242183	Wheel (front) steering knuckle oiler	-	-	2	2	2	
242185	Wheel (front) steering knuckle oiler elbow	-	-	2	2	2	
237163	Wheel (front) steering knuckle pin	2	-	-	-	-	
240030	Wheel (front) steering knuckle pin	-	-	2	-	-	
237077	Wheel (front) steering knuckle pin	-	2	-	2	2	
304599	Wheel (front) steering knuckle pin lock pin ...	2	2	2	2	2	
105242	Wheel (front) steering knuckle plug	-	4	-	4	4	
302551	Wheel (front) steering knuckle plug	4	-	-	-	-	
111561	Wheel (front) steering knuckle plug	-	-	4	-	-	

SERVICE PARTS LIST--PACKARD SUPER-EIGHT AND TWELVE

Wheel Suspension Front 253

Piece No.	Name	1500	1506	1603	1607	1707	
		1501	1507	1604	1608	1708	
		1502	1508	1605	No. Required		
302958	Wheel (front) steering knuckle shim (.053)	x	-	x	-	-	
316978	Shim (.054)	x	-	x	-	-	
316979	Shim (.055)	x	-	x	-	-	
302957	Shim (.056)	x	-	x	-	-	
316980	Shim (.057)	x	-	x	-	-	
316981	Shim (.058)	x	-	x	-	-	
302956	Shim (.059)	x	-	x	-	-	
316982	Shim (.060)	x	-	x	-	-	
316983	Shim (.061)	x	-	x	-	-	
302952	Shim (.062)	x	-	x	-	-	
316984	Shim (.063)	x	-	x	-	-	
316985	Shim (.064)	x	-	x	-	-	
302955	Shim (.065)	x	-	x	-	-	
316986	Shim (.066)	x	-	x	-	-	
316987	Shim (.067)	x	-	x	-	-	
302954	Shim (.068)	x	-	x	-	-	
316988	Shim (.069)	x	-	x	-	-	
316989	Shim (.070)	x	-	x	-	-	
302953	Shim (.071)	x	-	x	-	-	
316990	Shim (.072)	x	-	x	-	-	
237083	Wheel (front) steering knuckle shim (.053)	-	x	x	x	x	
237970	Shim (.054)	-	x	x	x	x	
237971	Shim (.055)	-	x	x	x	x	
237084	Shim (.056)	-	x	x	x	x	
237972	Shim (.057)	-	x	x	x	x	
237973	Shim (.058)	-	x	x	x	x	
237085	Shim (.059)	-	x	x	x	x	
237974	Shim (.060)	-	x	x	x	x	
237975	Shim (.061)	-	x	x	x	x	
237082	Shim (.062)	-	x	x	x	x	
237976	Shim (.063)	-	x	x	x	x	
237977	Shim (.064)	-	x	x	x	x	
237086	Shim (.065)	-	x	x	x	x	
237978	Shim (.066)	-	x	x	x	x	
237979	Shim (.067)	-	x	x	x	x	
237087	Shim (.068)	-	x	x	x	x	
237980	Shim (.069)	-	x	x	x	x	
237981	Shim (.070)	-	x	x	x	x	
237088	Shim (.071)	-	x	x	x	x	
237982	Shim (.072)	-	x	x	x	x	
232843	Wheel (front) support--right	1	-	-	-	-	
240040	Wheel (front) support--right	-	-	1	-	-	
232842	Wheel (front) support--left	1	-	-	-	-	
240039	Wheel (front) support--left	-	-	1	-	-	
237094	Wheel (front) support--left assembly	-	1	-	1	1	
237095	Wheel (front) support--right assembly	-	1	-	1	1	
237134	Wheel (front) support-arm assembly--right	1	-	1	-	-	
237064	Wheel (front) support-arm assembly--right	-	1	-	1	1	
237133	Wheel (front) support-arm assembly--left	1	-	1	-	-	
237063	Wheel (front) support-arm assembly--left	-	1	-	1	1	

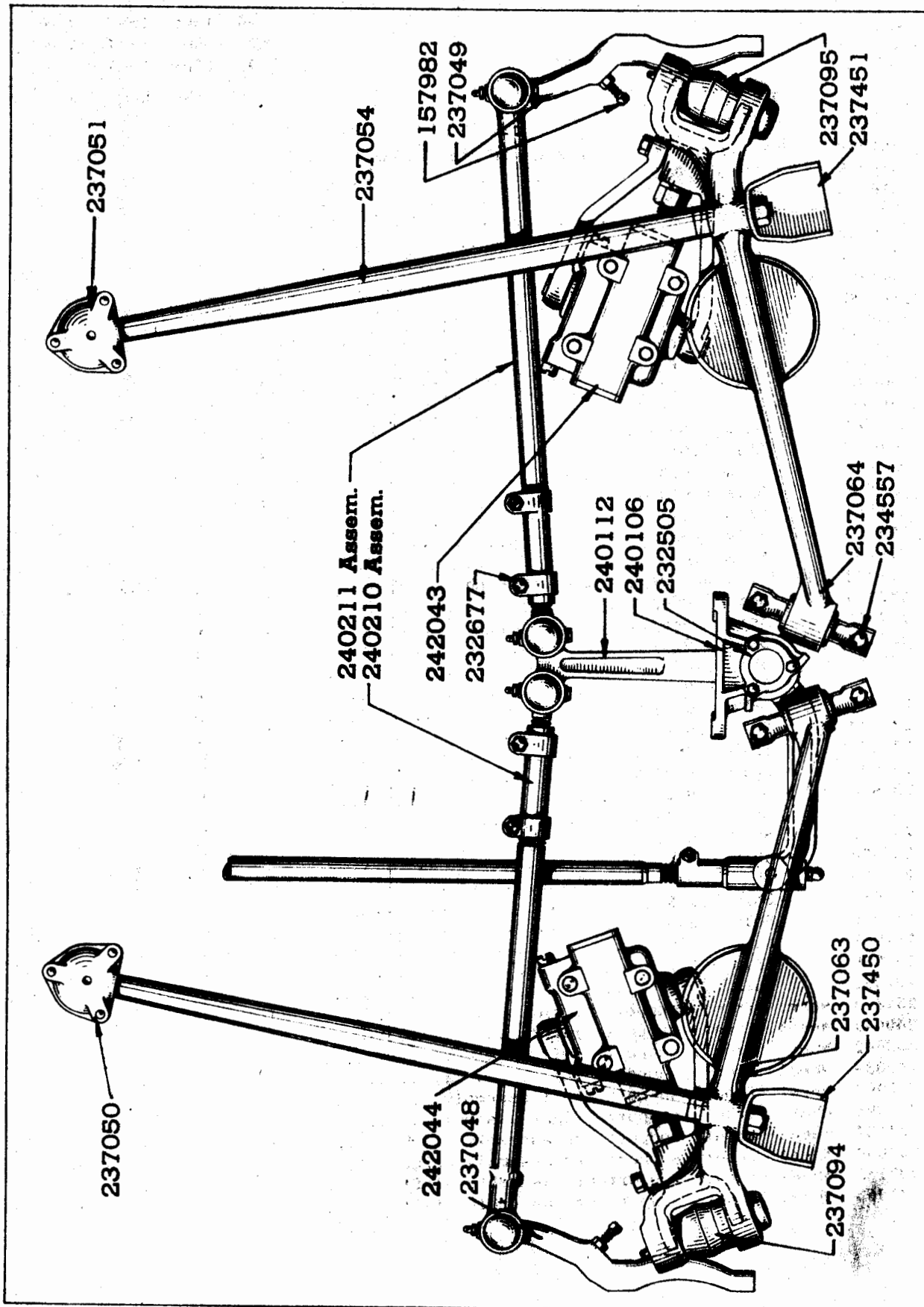

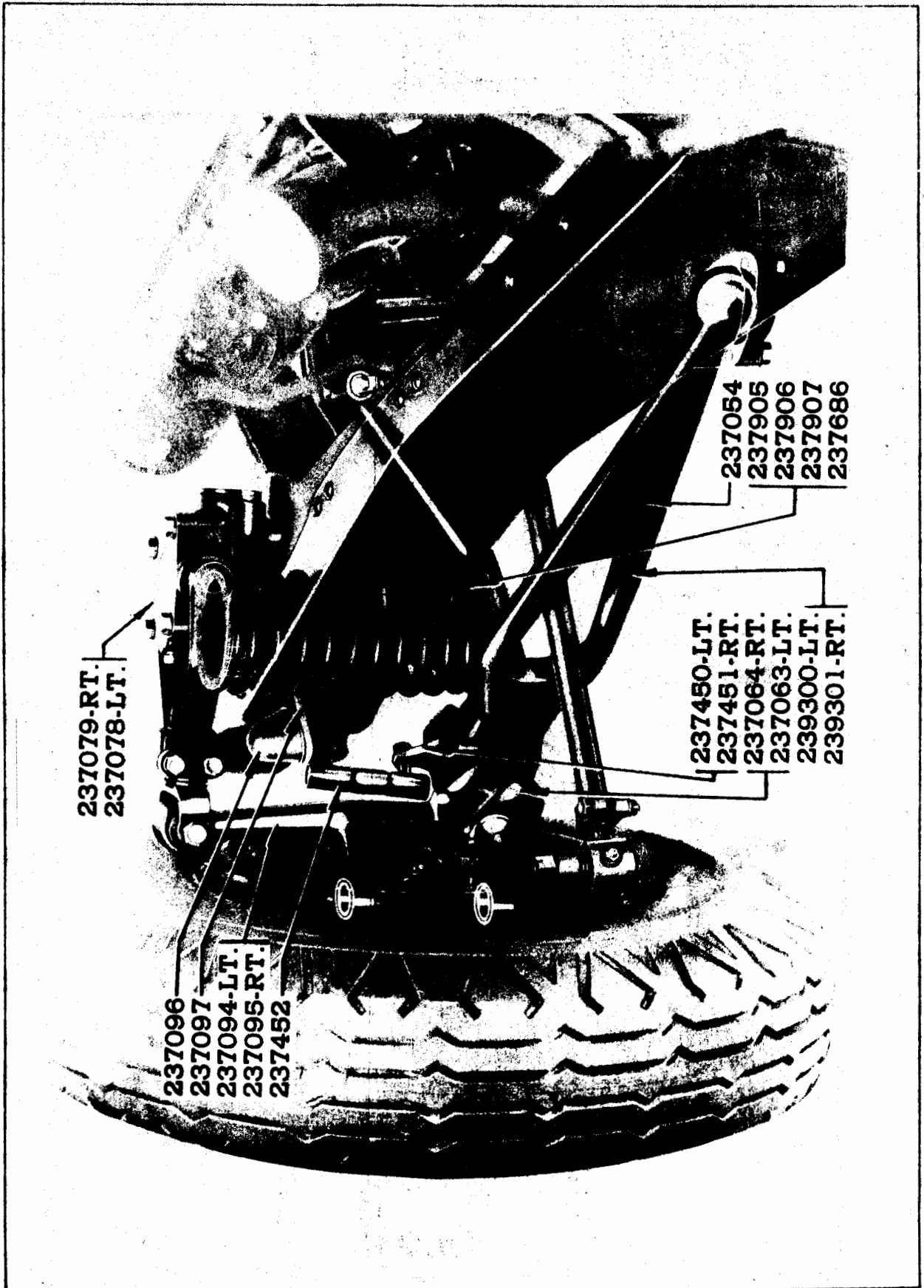

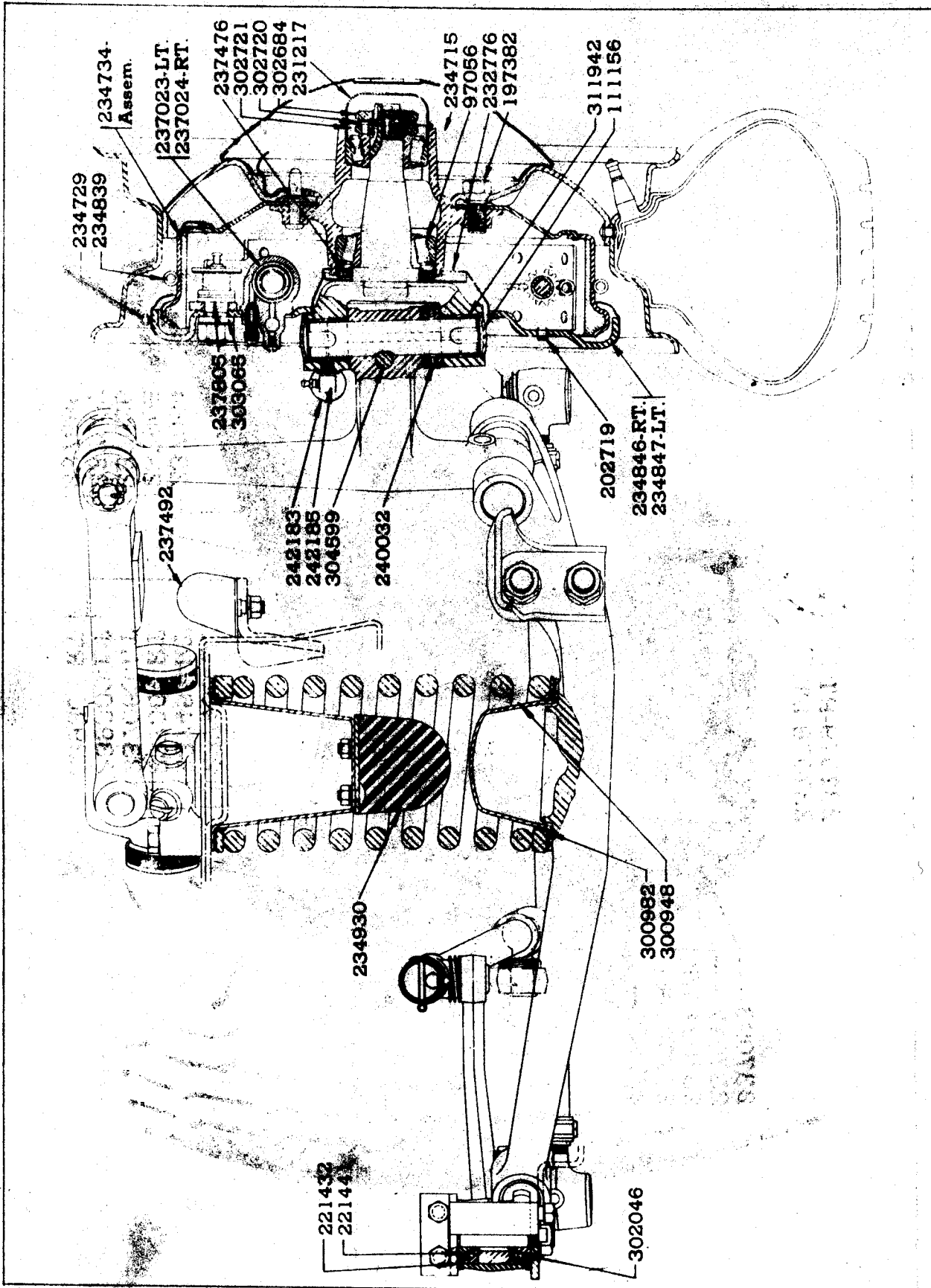

Models 1603-4-5

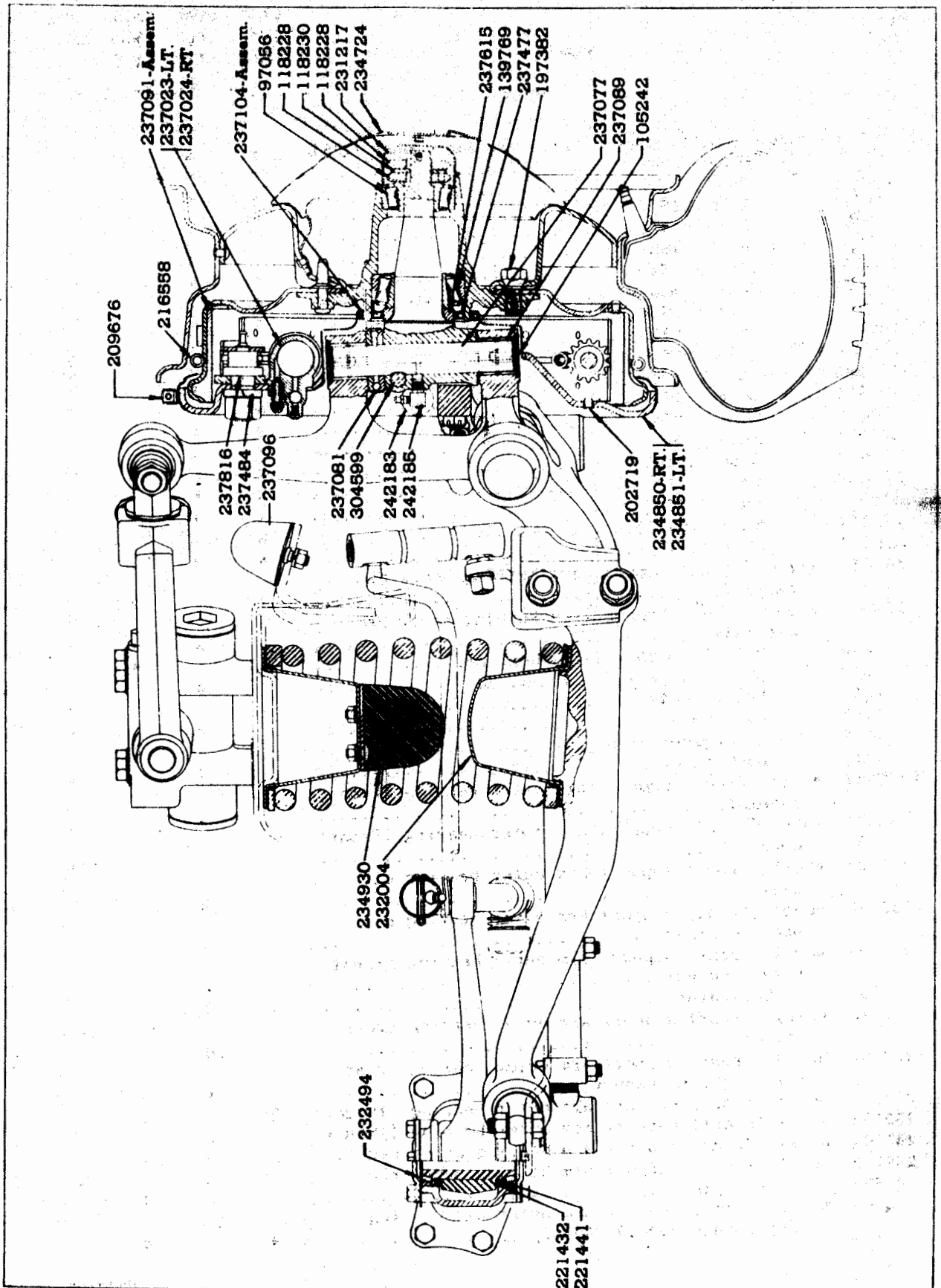

Models 1607-8, 1707-8

Piece No.	Name	1500	1506	1603	1607	1707	
		1501	1507	1604	1608	1708	
		1502	1508	1605	No. Required		
302958	Wheel (front) support arm brg. outer shim (.053)	x	x	-	-	-	
316978	Shim (.054)	x	x	-	-	-	
316978	Shim (.055)	x	x	-	-	-	
302957	Shim (.056)	x	x	-	-	-	
316980	Shim (.057)	x	x	-	-	-	
316981	Shim (.058)	x	x	-	-	-	
302956	Shim (.059)	x	x	-	-	-	
316982	Shim (.060)	x	x	-	-	-	
316983	Shim (.061)	x	x	-	-	-	
302952	Shim (.062)	x	x	-	-	-	
316984	Shim (.063)	x	x	-	-	-	
316985	Shim (.064)	x	x	-	-	-	
302955	Shim (.065)	x	x	-	-	-	
316986	Shim (.066)	x	x	-	-	-	
316987	Shim (.067)	x	x	-	-	-	
302954	Shim (.068)	x	x	-	-	-	
316988	Shim (.069)	x	x	-	-	-	
316989	Shim (.070)	x	x	-	-	-	
302953	Shim (.071)	x	x	-	-	-	
316990	Shim (.072)	x	x	-	-	-	
302867	Wheel (front) support arm bearing inner pin assembly	2	-	2	-	-	
234557	Wheel (front) support arm bearing inner pin assembly	-	2	-	2	2	
7890	Bolt 7/16-20 x 1-1/2 hex. hd.	4	-	4	-	-	
7843	Bolt 1/2-20 x 1-1/2 hex. hd.	-	4	-	4	4	
7007	Nut 7/16-20	4	-	4	-	-	
7008	Nut 1/2-20	-	4	-	4	4	
6045	Lockwasher 7/16	4	-	4	-	-	
6047	Lockwasher 1/2	-	4	-	4	4	
0239039	Wheel (front) support arm outer bearing (front) assembly	-	2	-	2	2	
232605	Wheel (front) support arm outer bearing (front) cover	-	2	-	2	2	
232722	Wheel (front) support arm outer bearing oil seal	-	2	-	2	2	
232723	Wheel (front) support arm outer bearing oil seal retainer	-	2	-	2	2	
232705	Wheel (front) support arm outer bearing (front) retaining nut	-	4	-	4	4	
70134	Lockwasher	-	2	-	2	2	
302578	Wheel (front) support arm outer bearing (rear) roller	-	66	-	66	66	
232962	Wheel (front) support arm outer bearing (rear) roller thrust washer	-	4	-	4	4	
300278	Wheel (front) support arm outer bearing (thrust)	2	-	2	-	-	
232759	Wheel (front) support arm outer bearing (thrust)	-	2	-	2	2	
237164	Wheel (front) support arm bearing outer pin	2	-	2	-	-	
232763	Wheel (front) support arm bearing outer pin	-	2	-	2	2	
304599	Lock pin	2	-	2	-	-	
326765	Wheel (front) support arm outer pin bearing (Supersedes 300659-300421)	4	-	4	-	-	

SERVICE PARTS LIST—PACKARD SUPER-EIGHT AND TWELVE

Wheel Suspension Front 259

Piece No.	Name	1500	1506	1603	1607	1707
		1501	1507	1604	1608	1708
		1502	1508	1605	No. Required	
4506	Wheel (front) support arm bearing outer pin key No. 110--3/16 x 7/8	-	2	-	2	2
300413	Wheel (front) support arm bearing plug-- tapped	2	-	2	-	-
232720	Wheel (front) support arm bearing plug--rear ..	-	2	-	2	2
302739	Wheel (front) support arm bearing plug--rear oiler	2	2	2	2	2
302738	Wheel (front) support arm bearing plug-- plain	2	-	2	-	-
6343	Wheel (front) support arm to torque arm dowel .	2	2	2	2	2
302738	Wheel (front) support arm plug front	2	-	2	-	-
302739	Wheel (front) support arm plug front oiler	2	-	-	-	-
300413	Wheel (front) support arm plug--rear	2	-	2	-	-
231481	Wheel (front) support bushing assembly--upper .	2	-	2	-	-
234929	Wheel (front) support bushing upper assembly ..	-	2	-	2	2
237089	Wheel (front) support bushing	-	4	-	4	4
303073	Wheel (front) support bushing upper bolt	2	-	2	-	-
232274	Wheel (front) support bushing upper bolt	-	2	-	2	2
196878	Wheel (front) support bushing upper bolt nut ..	2	-	2	-	-
232604	Wheel (front) support bushing upper bolt nut ..	-	2	-	2	2
4308	Cotter pin 1/8 x 1-3/8	2	-	2	-	-
6679	Lockwasher 11/16 (Shakeproof)	-	2	-	2	2
234926	Wheel (front) support bushing upper clevis	-	2	-	2	2
237065	Wheel (front) support bushing upper clevis spacer 1/8 thick	-	4	-	4	4
237066	Clevis spacer 3/16 thick	-	x	-	x	x
237067	Clevis spacer 1/4 thick	-	x	-	x	x
237753	Clevis spacer 5/16 thick	-	x	-	x	x
7014	Nut 7/8-14 hex.	-	2	-	2	2
5520	Lockwasher 7/8	-	2	-	2	2
303083	Wheel (front) support bushing upper bolt washer	4	-	4	-	-
303075	Wheel (front) support bushing upper pilot (no offset)	x	-	x	-	-
303076	Pilot (1/16 offset)	x	-	x	-	-
303077	Pilot (1/8 offset)	x	-	x	-	-
303078	Pilot (3/16 offset)	x	-	x	-	-
237881	Wheel (front) torque arm and studs assembly ...	2	-	2	-	-
237054	Wheel (front) torque arm and studs assembly ...	-	2	-	2	2
304442	Wheel (front) torque arm rubber bushing	2	2	2	2	2
0239342	Wheel (front) torque arm shim 1°	-	x	-	x	x
304698	Wheel (front) torque arm shim 1°	x	-	x	-	-
0304699	Wheel (front) torque arm shim 1/2°	x	-	x	-	-
0239343	Wheel (front) torque arm shim 1/2°	-	x	-	x	x
237962	Wheel (front) torque arm stud	4	-	4	-	-
237963	Wheel (front) torque arm stud	-	4	-	4	4
237964	Nut	4	4	4	4	4
6717	Lockwasher	4	4	4	4	4

Piece No.	Name	1500	1506	1603	1607	1707
		1501	1507	1604	1608	1708
		1502	1508	1605	No. Required	
WHEEL CARRIER (REAR)						
225825	Rear wheel carrier bracket (Specify color) (Use with bodies 1018-19-38-39-1118-19- 38-39-1238-39)	1	1	1	1	1
225727	Rear wheel carrier bracket brace (Specify color) (Use with bodies 1018-19-38-39-1118- 19-38-39-1238-39)	1	1	1	1	1
6361	Lockwasher 3/4 (Shakeproof) (Use with bodies 1018-19-38-39-1118-19-38-39- 1238-39)	2	2	2	2	2
158003	Nut (Specify color) (Use with bodies 1018-19-38-39-1118-19-38-39-1238-39) ...	2	2	2	2	2
225817	Rear wheel carrier bracket brace grommet (Use with bodies 1018-19-38-39-1118-19-38-39- 1238-39)	1	1	1	1	1
207332	Rear wheel carrier bracket dowel (Use with bodies 1018-19-38-39-1118-19-38-39-1238-39) .	1	1	1	1	1
225806	Rear wheel carrier bracket to frame screw (Use with bodies 1018-19-38-39-1118-19-38-39- 1238-39)	2	2	2	2	2
6361	Lockwasher 3/4 (Shakeproof) (Use with bodies 1018-19-38-39-1118-19-38-39- 1238-39)	2	2	2	2	2
225821	Rear wheel carrier bracket grommet (Use with bodies 1018-19-38-39-1118-19-38-39-1238-39) .	2	2	2	2	2
234785	Rear wheel carrier bracket spacer and dowel assembly (Specify color) (Use with bodies 1018-19-1118-19)	1	-	1	-	-
239198	Rear wheel carrier bracket spacer and dowel assembly (Specify color) (Use with bodies 1038-39-1138-39-1238-39)	-	1	-	1	1
7890	Rear wheel carrier bracket spacer to bracket screw 7/16-20 x 1-1/2 hex. hd. (Use with bodies 1018-19-38-39-1118-19-38-39-1238-39) .	3	3	3	3	3
5806	Lockwasher 7/16 (Shakeproof) (Use with bodies 1018-19-38-39-1118-19-38-39- 1238-39)	3	3	3	3	3
338811	Bolt 9/16 (Use with bodies 1018-19-1118- 19-38-39-1238-39) (Supersedes 197382) ..	1	-	1	1	1
234768	Rear wheel carrier lock (Use with bodies 1018- 19-1118-19)	1	-	1	-	-
201644	Rear wheel carrier lock (Use with bodies 1038- 39-1138-39-1238-39)	-	1	-	1	1
201643	Rear wheel carrier lock plate (Use with bodies 1038-39-1138-39-1238-39)	-	1	-	1	1
234686	Rear wheel carrier lock plate (Use with bodies 1018-19-1118-19)	1	-	1	-	-
338811	Rear wheel carrier wheel bolt (Use with bodies 1018-19-38-39-1118-19-38-39-1238-39) (Supersedes 197382)	3	2	3	3	3

SERVICE PARTS LIST--PACKARD SUPER-EIGHT AND TWELVE

Wheel Carrier (Side) 261

Piece No.	Name	1500	1506	1603	1607	1707	
		1501	1507	1604	1608	1708	
		1502	1508	1605	No. Required		
WHEEL CARRIER (SIDE)							
0239340	Side wheel carrier equipment (Used on bodies 1018-1019)	1	-	-	-	-	
0239341	Side wheel carrier equipment (Used on bodies 1003-07-12-13-16-17)	1	-	-	-	-	
0239344	Side wheel carrier equipment (Used on bodies 1014-15)	1	-	-	-	-	
0239345	Side wheel carrier equipment (Used on bodies 1038-1039)	-	1	-	-	-	
0239346	Side wheel carrier equipment (Used on bodies 1027-32-33-36-37)	-	1	-	-	-	
0239347	Side wheel carrier equipment (Used on bodies 1034-1035)	-	1	-	-	-	
0242313	Side wheel carrier equipment (Used on bodies 1118-19)	-	-	1	-	-	
0242315	Side wheel carrier equipment (Used on bodies 1103-07-12-13-16-17)	-	-	1	-	-	
0242316	Side wheel carrier equipment (Used on bodies 1114-15)	-	-	1	-	-	
0242314	Side wheel carrier equipment (Used on bodies 1138-39)	-	-	-	1	-	
0242317	Side wheel carrier equipment (Used on bodies 1127-32-33-36-37)	-	-	-	1	-	
0242318	Side wheel carrier equipment (Used on bodies 1134-1135)	-	-	-	1	-	
0242894	Side wheel carrier equipment (Used on bodies 1238-39)	-	-	-	-	1	
0242895	Side wheel carrier equipment (Used on bodies 1227-32-33-36-37)	-	-	-	-	1	
0242896	Side wheel carrier equipment (Used on bodies 1234-35)	-	-	-	-	1	
234639	Side wheel carrier brace (Specify color)	2	-	-	-	-	
240594	Side wheel carrier brace (Specify color)	-	-	2	-	-	
234640	Side wheel carrier brace (Specify color)	-	2	-	-	-	
240592	Side wheel carrier brace (Specify color)	-	-	-	2	2	
219752	Nut 7/8	4	4	-	-	-	
6280	Lockwasher 7/8 (Shakeproof)	2	2	-	-	-	
5510	Lockwasher 1/2	2	2	2	2	2	
7008	Nut 1/2-20	2	2	2	2	2	
234960	Side wheel carrier brace bracket lower--left (Specify color)	1	-	-	-	-	
234962	Side wheel carrier brace bracket lower--left (Specify color)	-	1	-	-	-	
234961	Side wheel carrier brace bracket lower--right (Specify color)	1	-	-	-	-	
234963	Side wheel carrier brace bracket lower--right (Specify color)	-	1	-	-	-	

Piece No.	Name	1500	1506	1603	1607	1707	
		1501	1507	1604	1608	1708	
		1502	1508	1605	No. Required		
240593	Side wheel carrier brace bracket	-	-	2	2	2	
303173	Side wheel carrier brace bracket pivot pin	-	-	2	2	2	
304704	Side wheel carrier brace upper grommet	2	2	-	-	-	
237045	Side wheel carrier brace to fender grommet	2	2	-	-	-	
316398	Side wheel carrier lock (with key)	2	2	-	-	-	
234768	Side wheel carrier lock	-	-	2	2	2	
304479	Side wheel carrier lock anchor (Specify color).	2	-	-	-	-	
234853	Side wheel carrier lock anchor (Specify color).	-	2	-	-	-	
303173	Side wheel carrier lock anchor pin	2	2	-	-	-	
304480	Side wheel carrier lock anchor bracket (Specify color)	2	2	-	-	-	
6092	Clamp bolt 3/8-24 x 1-1/2 hex. hd.	2	2	-	-	-	
7006	Nut 3/8-24	2	2	-	-	-	
5506	Lockwasher 3/8	2	2	-	-	-	
303623	Side wheel carrier lock cylinder	2	2	2	2	2	
234638	Side wheel carrier lock plate	2	-	-	-	-	
240565	Side wheel carrier lock plate	-	-	2	-	-	
234899	Side wheel carrier lock plate	-	2	-	-	-	
240582	Side wheel carrier lock plate	-	-	-	2	2	
234853	Side wheel carrier lock rod	-	-	2	2	2	
5976	Screw 5/16-18 x 5/8 hex. hd.	-	-	4	4	4	
5504	Lockwasher 5/16	-	-	4	4	4	
6357	Washer 5/16	-	-	4	4	4	
240590	Side wheel carrier lock rod bracket	-	-	2	2	2	
303173	Side wheel carrier lock rod bracket pivot pin .	-	-	2	2	2	
207750	Spring washer	-	-	x	x	x	
234994	Side wheel carrier wheel support	-	2	-	-	-	
234630	Side wheel carrier wheel support	2	-	-	-	-	
6092	Clamp bolt 3/8-24 x 1 hex. hd.	2	2	-	-	-	
7006	Nut 3/8-24	2	2	-	-	-	
5506	Lockwa	2	2	-	-	-	

Piece No.	Name	(15th Series)									
		1012-32 5 P. Formal Sedan	1003-13-23-33 5 P. Tour. Sedan	1014-34 7 P. Tour. Sedan	1015-35 7 P. Tour. Sedan Lim.	1016-36 5 P. Club Sedan	1017-37 5 P. Coupe	1018-38 2-4 P. Coupe	1019-39 2-4 P. Conv. Coupe	1063-73 5 P. Conv. Sedan	1007-37 5 P. Victoria
		No. Required									
BODY ATTACHING PARTS											
7886	Body to frame bolt No. 1 (7/16-20 x 1-3/4 hex. hd.)	2	2	2	2	2	2	2	2	2	2
5282	Body to frame bolt No. 2 (7/16-20 x 3-1/2 hex. hd.)	2	2	2	2	2	2	2	2	2	2
235359	Body to frame bolt No. 2 (inside) (7/16-20 x 10-1/4 flat hd.)	-	-	-	-	-	-	-	2	2	2
5282	Body to frame bolt No. 3 (7/16-20 x 3-1/2 hex. hd.)	2	2	2	2	2	2	2	2	2	2
7954	Body to frame bolt No. 4 (7/16-20 x 3-1/4 hex. hd.)	-	-	-	-	-	2	2	2	-	2
7834	Body to frame bolt No. 4 (7/16-20 x 3-1/8 hex. hd.)	2	2	2	2	2	-	-	-	4	-
7954	Body to frame bolt No. 5 (7/16-20 x 3-1/4 hex. hd.)	4	4	4	4	4	4	4	4	-	4
7834	Body to frame bolt No. 5 (7/16-20 x 3-1/8 hex. hd.)	-	-	-	-	-	-	-	-	4	-
231547	Body to frame bolt No. 6 (7/16-20 x 5-5/8 hex. hd.)	2	2	2	2	2	2	2	2	2	2
7890	Body to frame bolt No. 7 (7/16-20 x 1-1/2 hex. hd.)	2	2	2	2	2	2	2	2	2	2
7890	Body to frame bolt No. 8 (7/16-20 x 1-1/2 hex. hd.)	2	2	2	2	2	2	2	2	2	2
3883	Body to frame bolt No. 1 washer 7/16 plain	1	1	1	1	1	1	-	-	1	1
131809	Body to frame bolt washer--large (7/16 spl.)	4	4	4	4	4	4	4	4	-	4
131046	Body to frame bolt washer--small(7/16 spl.)	26	26	26	26	24	24	24	24	28	24
5508	Body to frame bolt lockwasher 7/16	6	6	6	6	8	8	8	8	12	8
5806	Body to frame bolt lockwasher 7/16 (Shakeproof)	12	12	12	12	10	10	10	10	8	10
7007	Body to frame bolt nut 7/16-20	14	14	14	14	14	14	14	14	16	16
182439	Body to frame bolt nut lock	12	12	12	12	12	10	10	12	10	12
235416	Body to frame liner (1/16 thick)	-	-	-	-	-	-	-	-	X	X
185273	Body to frame liner (3/16 thick)	X	X	X	X	X	X	X	-	-	-
231975	Body to frame liner (1/8 thick)	-	-	-	-	-	-	-	X	X	X
185270	Body to frame liner (3/8 thick)	X	X	X	X	X	X	X	-	-	-
185274	Body to frame liner (1/4 thick)	X	X	X	X	X	X	X	-	-	-
226790	Body to frame liner (3/8 thick)	-	-	-	-	2	2	2	-	-	-
235397	Body to frame liner anti-squeak	-	-	-	-	-	-	-	X	X	X
308954	Body to frame liner shim--short (1/16 thick)	-	-	-	-	-	-	-	X	-	X
308953	Body to frame liner shim--short (1/8 thick)	-	-	-	-	-	-	-	4	-	4
235082	Body to frame liner--rear	1	1	1	1	-	-	4	-	1	-
235419	Body to frame liner--rear anti-squeak	-	-	-	-	-	-	-	4	-	4
185274	Body hold down bolt bracket liner (1/4 thick)	X	X	X	X	X	X	X	-	-	-
235416	Body hold down bolt bracket liner (1/16 thick)	-	-	-	-	-	-	-	X	X	X
185270	Body hold down bolt bracket liner (3/8 thick)	X	X	X	X	X	X	X	-	-	-
231975	Body hold down bolt bracket liner (1/8 thick)	-	-	-	-	-	-	-	X	X	X
185273	Body hold down bolt bracket liner (3/16 thick)	X	X	X	X	X	X	X	-	-	-
235397	Body hold down bolt bracket liner anti-squeak	-	-	-	-	-	-	-	X	X	X

Piece No.	(15th Series) Name	No. Required									
		1012-32 5 P. Formal Sedan	1003-13-23-33 5 P. Tour Sedan	1014-34 7 P. Tour Sedan	1015-35 7 P. Tour Sedan Lim	1016-36 5 P. Club Sedan	1017-37 5 P. Coupe	1018-38 2-4 P. Coupe	1019-39 2-4 P. Conv. Coupe	1063-73 5 P. Conv. Sedan	1007-27 5 P. Victoria
ANTI-RUMBLE AND ANTI-SQUEAK											
193674	Anti-rumble (body panel) adhesive compound .	x	x	x	x	x	x	x	x	-	-
184876	Anti-squeak compound	x	x	x	x	x	x	x	x	-	-
224775	Anti-squeak felt (1/4 x 2" wide strip)	x	x	x	x	x	-	-	-	-	-
181545	Anti-squeak tape 2"	x	x	x	x	x	x	x	x	-	-
187525	Anti-squeak tape 1-1/4"	x	x	x	x	x	x	x	x	-	-
51331	Anti-squeak tape 1-1/2"	x	x	x	x	x	x	x	x	-	-
39403	Anti-squeak tape 3/4"	x	x	x	x	x	x	x	x	-	-
314440	Body sealer--under body M.M.M.E.C. 93	x	x	x	x	x	x	x	x	-	-
314441	Body sealer--inner body M.M.M.E.C. 108	x	x	x	x	x	x	x	x	-	-

ARM REST

Always send samples of material when ordering trimmed assemblies, as the assemblies are upholstered to match the body interior.

233392	Arm rest (trimmed) assembly--right (Used on 1012-1003-1013)	1	1	-	-	-	-	-	-	-	-
233393	Arm rest (trimmed) assembly--left (Used on 1012-1003-1013)	1	1	-	-	-	-	-	-	-	-
224376	Arm rest (trimmed) assembly--right (Used on 1014)	-	-	1	-	-	-	-	-	-	-
224377	Arm rest (trimmed) assembly--left (Used on 1014)	-	-	1	-	-	-	-	-	-	-
224378	Arm rest (trimmed) assembly--right (Used on 1015)	-	-	-	1	-	-	-	-	-	-
224379	Arm rest (trimmed) assembly--left (Used on 1015)	-	-	-	1	-	-	-	-	-	-
224992	Arm rest (trimmed) assembly--right (Used on 1016)	-	-	-	-	1	-	-	-	-	-
224993	Arm rest (trimmed) assembly--left (Used on 1016)	-	-	-	-	1	-	-	-	-	-
226058	Arm rest (trimmed) assembly--right (Used on 1017)	-	-	-	-	-	1	-	-	-	-
226059	Arm rest (trimmed) assembly--left (Used on 1017)	-	-	-	-	-	1	-	-	-	-
233350	Arm rest (trimmed) assembly--right (Used on 1032)	1	-	-	-	-	-	-	-	-	-
233194	Arm rest (trimmed) assembly--right (Used on 1023-1033)	-	1	-	-	-	-	-	-	-	-
233195	Arm rest (trimmed) assembly--left (Used on 1023-1033)	-	1	-	-	-	-	-	-	-	-
233351	Arm rest (trimmed) assembly--left (Used on 1032)	1	-	-	-	-	-	-	-	-	-
233196	Arm rest (trimmed) assembly--right (Used on 1034)	-	-	1	-	-	-	-	-	-	-
233197	Arm rest (trimmed) assembly--left (Used on 1034)	-	-	1	-	-	-	-	-	-	-
233198	Arm rest (trimmed) assembly--right (Used on 1035)	-	-	-	1	-	-	-	-	-	-
233199	Arm rest (trimmed) assembly--left (Used on 1035)	-	-	-	1	-	-	-	-	-	-

Piece No.	Name	(15th Series)									
		1012-32 5 P. Formal Sedan	1003-13-23-33 5 P. Tour Sedan	1014-34 7 P. Tour Sedan	1015-35 7 P. Tour Sedan Lim.	1016-36 5 P. Club Sedan	1017-37 5 P. Coupe	1018-38 2-4 P. Coupe	1019-39 2-4 P. Conv. Coupe	1063-73 5 P. Conv. Sedan	1007-27 5 P. Victoria
		No. Required									
233200	Arm rest (trimmed) assembly--right (Used on 1036)	-	-	-	-	1	-	-	-	-	-
233201	Arm rest (trimmed) assembly--left (Used on 1036)	-	-	-	-	1	-	-	-	-	-
233202	Arm rest (trimmed) assembly--right (Used on 1037)	-	-	-	-	-	1	-	-	-	-
233203	Arm rest (trimmed) assembly--left (Used on 1037)	-	-	-	-	-	1	-	-	-	-
231806	Arm rest ash tray trim block-cover plate (Used on 1023-33-34-35-37)	-	2	2	2	-	2	-	-	-	-
29664	Tack 4 oz. trimmers Japanned (Used on 1023-33-34-35-37)	-	x	x	x	-	x	-	-	-	-
6230	Arm rest attaching screw 1/4-28 x 11/16 flat hd.	2	2	2	2	4	-	-	-	-	-
193730	Arm rest attaching screw ferrule 1/4	2	2	2	2	4	-	-	-	-	-
224142	Arm rest attaching key hole plate--right (Used on 1014-15-16-17-36-37)	-	-	1	1	1	1	-	-	-	-
235192	Arm rest attaching key hole plate--right (Used on 1012-32-1003-1013)	1	1	-	-	-	-	-	-	-	-
235193	Arm rest attaching key hole plate--left (Used on 1012-32-1003-1013)	1	1	-	-	-	-	-	-	-	-
224143	Arm rest attaching key hole plate--left (Used on 1014-15-16-17-36-37)	-	-	1	1	1	1	-	-	-	-
224914	Arm rest cushion--right (Used on 1017)	-	-	-	-	-	1	-	-	-	-
231890	Arm rest cushion--right (Used on 1037)	-	-	-	-	-	1	-	-	-	-
235186	Arm rest cushion--right (Used on 1012-32-1003-1013)	1	1	-	-	-	-	-	-	-	-
231800	Arm rest cushion--right (Used on 1023-1033)	-	1	-	-	-	-	-	-	-	-
224951	Arm rest cushion--left (Used on 1016)	-	-	-	-	1	-	-	-	-	-
224952	Arm rest cushion--left (Used on 1036)	-	-	-	-	1	-	-	-	-	-
224998	Arm rest cushion--left (Used on 1017)	-	-	-	-	-	1	-	-	-	-
231891	Arm rest cushion--left (Used on 1037)	-	-	-	-	-	1	-	-	-	-
235187	Arm rest cushion--left (Used on 1012-32-1003-1013)	1	1	-	-	-	-	-	-	-	-
231801	Arm rest cushion--left (Used on 1023-1033)	-	1	-	-	-	-	-	-	-	-
224188	Arm rest cushion--right (Used on 1014-15) ..	-	-	1	1	-	-	-	-	-	-
231804	Arm rest cushion--right (Used on 1034-35) ..	-	-	1	1	-	-	-	-	-	-
224860	Arm rest cushion--right (Used on 1016)	-	-	-	-	1	-	-	-	-	-
226387	Arm rest cushion--right (Used on 1036)	-	-	-	-	1	-	-	-	-	-
224876	Arm rest cushion--left (Used on 1014-15) ...	-	-	1	1	-	-	-	-	-	-
231805	Arm rest cushion--left (Used on 1034-35) ...	-	-	1	1	-	-	-	-	-	-

ASH TRAY

226032	Ash tray assembly (Used on 1016)	-	-	-	-	1	-	-	-	-	-
231814	Ash tray assembly--right (Used on 1036)	-	-	-	-	1	-	-	-	-	-
231815	Ash tray assembly--left (Used on 1036)	-	-	-	-	1	-	-	-	-	-
231808	Ash tray assembly (Used on 1023-33-34-35-37-1007-27-1063-73)	-	2	2	2	-	2	-	-	2	2
105029	Ash tray assembly spring dowel (1 required for 1016, 2 required for 1036)	-	-	-	-	-	-	-	-	-	-
235227	Ash tray (windshield moulding)	1	1	1	1	1	1	1	-	-	-
211026	Ash tray ash receiver (1 required for 1012-1003-1013-14-15-17, 2 required for 1032)	-	-	-	-	-	-	-	-	-	-



235227



16th Series
Only



0239616



225262-3-4-5



235266



231808



226306



211026

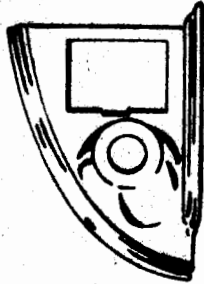

224504
224519
235102



226032



16th Series
Only

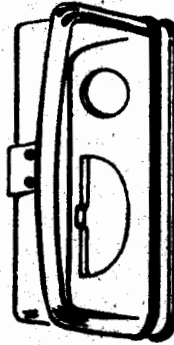

231814-231815



224675

Piece No.	(15th Series) Name	No. Required								
		1012-32 5 P. Formal Sedan	1003-13-23-33 5 P. Tour. Sedan	1014-34 7 P. Tour. Sedan	1015-35 7 P. Tour. Sedan Lim.	1016-36 5 P. Club Sedan	1017-37 5 P. Coupe	1018-38 2-4 P. Coupe	1019-39 2-4 P. Conv. Coupe	1063-73 5 P. Conv. Sedan
226306	Ashtray ash receiver (1 required for 1016, 2 required for 1036)	-	-	-	-	-	-	-	-	-
235265	Ash tray cigar lighter (complete) (Used on 1012-1003-13-17)	1	1	-	-	-	1	-	-	-
235264	Ash tray cigar lighter (complete) 2 required for 1032-36, 1 required for 1014-15-16	-	-	-	-	-	-	-	-	-
235263	Ash tray cigar lighter (complete) (Used on 1023-33-34-35)	-	2	2	2	-	-	-	-	-
235262	Ash tray cigar lighter (complete) (Used on 1037)	-	-	-	-	-	2	-	-	-
235266	Ash tray cigar lighter (knob and tip) (1 required for 1012-1003-13-14-15-16-17-1063-73-1007-1027, 2 required for 1032-23-33-34-35-36-37)	-	-	-	-	-	-	-	-	-
236653	Ash tray cigar lighter base	-	-	-	-	-	-	-	1	1
0239616	Ash tray cigar lighter tip (1 required for 1012-1003-13-14-15-16-17-1063-73-1007-27-2 required for 1032-23-33-34-35-36-37) (Supersedes 232380)	-	-	-	-	-	-	-	-	-
224504	Ash tray cover plate (Used on 1012-1003-13-17)	1	1	-	-	-	1	-	-	-
224675	Ash tray cover plate (Used on 1014-15)	-	-	1	1	-	-	-	-	-
235102	Ash tray cover plate—right (Used on 1032)	1	-	-	-	-	-	-	-	-
224519	Ash tray cover plate—left (Used on 1032)	1	-	-	-	-	-	-	-	-

DASH

231606	Dash panel assembly (L.H. drive)	1	1	1	1	1	1	1	1	1
231607	Dash panel assembly (R.H. drive)	1	1	1	1	1	1	1	1	1
199045	Clinch nut 1/4-28 thread	17	17	17	17	17	17	17	-	-
224072	Clinch nut 5/16-24 thread	1	1	1	1	1	1	1	-	-
224123	Dash panel bonnet dash liner—side	2	2	2	2	2	2	2	2	2
224124	Dash panel bonnet dash liner—top	2	2	2	2	2	2	2	2	2
228260	Dash panel bonnet dash liner hook	4	4	4	4	4	4	4	4	4
229340	Washer 3/16 (special)	4	4	4	4	4	4	4	4	4
7002	Nut No. 8-32 thread	4	4	4	4	4	4	4	4	4
228251	Dash panel bonnet dash liner hook saddle	4	4	4	4	4	4	4	4	4
187803	Dash panel bonnet dash liner staple 3/4" long	6	6	6	6	6	6	6	6	6
228284	Dash panel bonnet dash liner staple weatherstrip	x	x	x	x	x	x	x	x	x
228246	Dash panel bonnet dash liner staple saddle	6	6	6	6	6	6	6	6	6
231610	Dash panel inter-liner (L.H. drive)	1	1	1	1	1	1	1	1	1
231611	Dash panel inter-liner (R.H. drive)	1	1	1	1	1	1	1	1	1
231605	Dash panel liner assembly (R.H. drive)	1	1	1	1	1	1	1	1	1
231604	Dash panel liner assembly (L.H. drive)	1	1	1	1	1	1	1	1	1
111074	Dash panel liner snap fastener stud (eyelet type)	7	7	7	7	7	7	7	7	7
123094	Dash panel liner snap fastener stud (eyelet)	7	7	7	7	7	7	7	7	7
5317	Dash panel liner screw 1/4-28 x 1-1/8 hex. hd.	2	2	2	2	2	2	2	2	2
5502	Lockwasher 1/4	2	2	2	2	2	2	2	2	2
62065	Washer 1/4 plain	1	1	1	1	1	1	1	1	1
220976	Dash panel to sill screw 5/16-24 x 4-1/4 hex. hd.	2	2	2	2	2	2	2	-	-
6070	Lockwasher 5/16 (Shakeproof) (Woodtype).	2	2	2	2	2	2	2	-	-

Piece No.	Name	(15th Series)									
		1012-32 5 P. Formal Sedan	1003-13-23-33 5 P. Tour. Sedan	1014-34 7 P. Tour. Sedan	1015-35 7 P. Tour. Sedan Lim.	1016-36 5 P. Club Sedan	1017-37 5 P. Coupe	1018-38 2-4 P. Coupe	1019-39 2-4 P. Conv. Coupe	1063-73 5 P. Conv. Sedan	1007-27 5 P. Victoria
		No. Required									
224251	Screw boss 5/16-24 thread	2	2	2	2	2	2	2	2	-	-
5271	Nail No. 15 x 3/4 panel	x	x	x	x	x	x	x	x	-	-

DOOR

All doors must be adjusted to each respective body. To obtain satisfactory replacement of doors, it is advisable to return the damaged door to be repaired, if possible. If this cannot be done, the customer assumes the responsibility of the new door being a satisfactory fit. Specify on all orders the upholstery material, color and striping.

0235457	Door front right trimmed assembly (Used on 1003-16)	-	1	-	-	1	-	-	-	-	-
0235458	Door front right trimmed assembly (Used on 1023-36)	-	1	-	-	1	-	-	-	-	-
0235459	Door front right trimmed assembly (Used on 1012-13-14)	1	1	1	-	-	-	-	-	-	-
0235460	Door front right trimmed assembly (Used on 1032-33-34)	1	1	1	-	-	-	-	-	-	-
0235461	Door front right trimmed assembly (Used on 1015)	-	-	-	1	-	-	-	-	-	-
0235462	Door front right trimmed assembly (Used on 1035)	-	-	-	1	-	-	-	-	-	-
0235463	Door front right trimmed assembly (Used on 1017)	-	-	-	-	-	1	-	-	-	-
0235464	Door front right trimmed assembly (Used on 1037)	-	-	-	-	-	1	-	-	-	-
0235465	Door front right trimmed assembly (Used on 1018)	-	-	-	-	-	-	1	-	-	-
0235466	Door front right trimmed assembly (Used on 1038)	-	-	-	-	-	-	1	-	-	-
0235467	Door front right trimmed assembly (Used on 1019)	-	-	-	-	-	-	-	1	-	-
0235468	Door front right trimmed assembly (Used on 1039)	-	-	-	-	-	-	-	1	-	-
0235469	Door front left trimmed assembly (Used on 1003-16)	-	1	-	-	1	-	-	-	-	-
0235470	Door front left trimmed assembly (Used on 1023-36)	-	1	-	-	1	-	-	-	-	-
0235471	Door front left trimmed assembly (Used on 1012-13-14)	1	1	1	-	-	-	-	-	-	-
0235472	Door front left trimmed assembly (Used on 1032-33-34)	1	1	1	-	-	-	-	-	-	-
0235473	Door front left trimmed assembly (Used on 1015)	-	-	-	1	-	-	-	-	-	-
0235474	Door front left trimmed assembly (Used on 1035)	-	-	-	1	-	-	-	-	-	-
0235475	Door front left trimmed assembly (Used on 1017)	-	-	-	-	-	1	-	-	-	-
0235476	Door front left trimmed assembly (Used on 1037)	-	-	-	-	-	1	-	-	-	-

(15th Series)

Piece No.	Name											No. Required	
		1012-32 5 P. Formal Sedan	1003-13-23-33 5 P. Tour. Sedan	1014-34 7 P. Tour. Sedan	1015-35 7 P. Tour. Sedan Lim.	1016-36 5 P. Club Sedan	1017-37 5 P. Coupe	1018-38 2-4 P. Coupe	1019-39 2-4 P. Conv. Coupe	1063-73 5 P. Conv. Sedan	1007-27 5 P. Victoria		
0235477	Door front left trimmed assembly (Used on 1018)	-	-	-	-	-	-	-	-	-	1	-	-
0235478	Door front left trimmed assembly (Used on 1038)	-	-	-	-	-	-	-	-	-	1	-	-
0235479	Door front left trimmed assembly (Used on 1019)	-	-	-	-	-	-	-	-	-	-	1	-
0235480	Door front left trimmed assembly (Used on 1039)	-	-	-	-	-	-	-	-	-	-	1	-
0235481	Door rear left trimmed assembly (Used on 1012)	1	-	-	-	-	-	-	-	-	-	-	-
0235482	Door rear left trimmed assembly (Used on 1032)	1	-	-	-	-	-	-	-	-	-	-	-
0235483	Door rear left trimmed assembly (Used on 1003)	-	1	-	-	-	-	-	-	-	-	-	-
0235484	Door rear left trimmed assembly (Used on 1023)	-	1	-	-	-	-	-	-	-	-	-	-
0235485	Door rear left trimmed assembly (Used on 1013)	-	1	-	-	-	-	-	-	-	-	-	-
0235486	Door rear left trimmed assembly (Used on 1033)	-	1	-	-	-	-	-	-	-	-	-	-
0235487	Door rear left trimmed assembly (Used on 1014-15)	-	-	1	1	-	-	-	-	-	-	-	-
0235488	Door rear left trimmed assembly (Used on 1034-35)	-	-	1	1	-	-	-	-	-	-	-	-
0235489	Door rear left trimmed assembly (Used on 1016)	-	-	-	-	1	-	-	-	-	-	-	-
0235490	Door rear left trimmed assembly (Used on 1036)	-	-	-	-	1	-	-	-	-	-	-	-
0235491	Door rear right trimmed assembly (Used on 1012)	1	-	-	-	-	-	-	-	-	-	-	-
0235492	Door rear right trimmed assembly (Used on 1032)	1	-	-	-	-	-	-	-	-	-	-	-
0235493	Door rear right trimmed assembly (Used on 1003)	-	1	-	-	-	-	-	-	-	-	-	-
0235494	Door rear right trimmed assembly (Used on 1023)	-	1	-	-	-	-	-	-	-	-	-	-
0235495	Door rear right trimmed assembly (Used on 1013)	-	1	-	-	-	-	-	-	-	-	-	-
0235496	Door rear right trimmed assembly (Used on 1033)	-	1	-	-	-	-	-	-	-	-	-	-
0235497	Door rear right trimmed assembly (Used on 1014-15)	-	-	1	1	-	-	-	-	-	-	-	-
0235498	Door rear right trimmed assembly (Used on 1034-35)	-	-	1	1	-	-	-	-	-	-	-	-
0235499	Door rear right trimmed assembly (Used on 1016)	-	-	-	-	1	-	-	-	-	-	-	-
0235500	Door rear right trimmed assembly (Used on 1036)	-	-	-	-	1	-	-	-	-	-	-	-

Piece No.	(15th Series) Name	No. Required										
		1012-32 5 P. Formal Sedan	1003-13-23-33 5 P. Tour. Sedan	1014-34 7 P. Tour. Sedan	1015-35 7 P. Tour. Sedan Lim	1016-36 5 P. Club Sedan	1017-37 5 P. Coupe	1018-38 2-4 P. Coupe	1019-39 2-4 P. Conv. Coupe	1063-73 5 P. Conv. Sedan	1007-27 5 P. Victoria	

DOOR ARM REST

Always send samples of material when ordering trimmed assemblies, as the assemblies are upholstered to match the body interior.

233384	Door arm rest (trimmed) assembly--right	1	1	1	-	1	1	1	-	-	-
233385	Door arm rest (trimmed) assembly--left	1	1	1	-	1	1	1	-	-	-
233382	Door arm rest (trimmed) assembly--right	-	-	-	1	-	-	-	1	-	-
233383	Door arm rest (trimmed) assembly--left	-	-	-	1	-	-	-	1	-	-
231970	Door rest cushion--right	1	1	1	1	1	1	1	1	1	1
231971	Door arm rest cushion--left	1	1	1	1	1	1	1	1	1	1
231972	Door arm rest support--right	1	1	1	1	1	1	1	1	1	1
231973	Door arm rest support--left	1	1	1	1	1	1	1	1	1	1
231976	Door arm rest support trim stick	2	2	2	2	2	2	2	2	2	2

DOOR PARTS

308103	Front door anti-rattler--upper 1/4"	2	2	2	2	2	2	2	-	-	-
308102	Front door anti-rattler--upper 3/16"	2	2	2	2	2	2	2	-	-	-
199167	Front door anti-rattler--lower	2	2	2	2	2	2	2	2	2	2
218305	Front door anti-rattler shim	x	x	x	x	x	x	x	x	x	x
185602	Front door bumper (1-9/32)	x	x	x	x	x	x	x	x	x	x
185601	Front door bumper (1-11/32)	x	x	x	x	x	x	x	x	x	x
185600	Front door bumper (1-13/32)	x	x	x	x	x	x	x	x	x	x
218685	Front door bumper (1-15/32)	x	x	x	x	x	x	x	x	x	x
236688	Front door diagonal brace	-	-	-	-	-	-	-	2	-	2
236732	Front door diagonal brace--right	-	-	-	-	-	-	-	-	1	-
236733	Front door diagonal brace--left	-	-	-	-	-	-	-	-	1	-
235046	Front door dovetail--male	2	2	2	2	2	2	2	4	4	2
6727	Front door dovetail--male screw 1/4-28 x 1-1/2 flat hd.	-	-	-	-	-	-	-	8	8	8
235042	Front door dovetail--female (single)	2	2	2	2	2	2	2	-	-	-
235559	Front door dovetail--female (double) (Supersedes 224171)	-	-	-	-	-	-	-	2	2	2
229986	Front door hinge lower--right	1	1	1	1	1	1	1	-	-	-
230578	Front door hinge lower--right	-	-	-	-	-	-	-	1	1	1
229987	Front door hinge lower--left	1	1	1	1	1	1	1	-	-	-
230579	Front door hinge lower--left	-	-	-	-	-	-	-	1	1	1
6672	Screw 1/4-28 x 4-1/8 oval hd.	4	4	4	4	4	4	4	-	-	-
236062	Screw 5/16-24 x 5 flat hd. special	-	-	-	-	-	-	-	4	4	4
6449	Screw 1/4-28 x 2-3/8 flat hd.	4	4	4	4	4	4	4	-	-	-
236060	Screw 5/16-24 x 2 flat hd. (special)	-	-	-	-	-	-	-	4	4	4
5899	Lockwasher 5/16 countersunk (Shakeproof)	-	-	-	-	-	-	-	16	16	16
184692	Screw boss 1/4-28 (Floating nut type)	4	4	4	4	4	4	4	-	-	-
229988	Front door hinge upper right assembly	1	1	1	1	1	1	1	1	1	1
229989	Front door hinge upper left assembly	1	1	1	1	1	1	1	1	1	1
6449	Screw 1/4-28 x 2-3/8 flat hd.	8	8	8	8	8	8	8	-	-	-
5693	Screw 1/4-28 x 2-1/2 flat hd.	-	-	-	-	-	-	-	2	2	2
8204	Screw 1/4-28 x 2 flat hd.	-	-	-	-	-	-	-	6	6	6
5899	Lockwasher 5/16 countersunk (Shakeproof)	8	8	8	8	8	8	8	8	8	8
7819	Screw 3/8-24 x 1 hex. hd.	6	6	6	6	6	6	6	6	6	6
5506	Lockwasher 3/8	6	6	6	6	6	6	6	6	6	6
310588	Front door hinge upper assembly stop bumper.	2	2	2	2	2	2	2	2	2	2

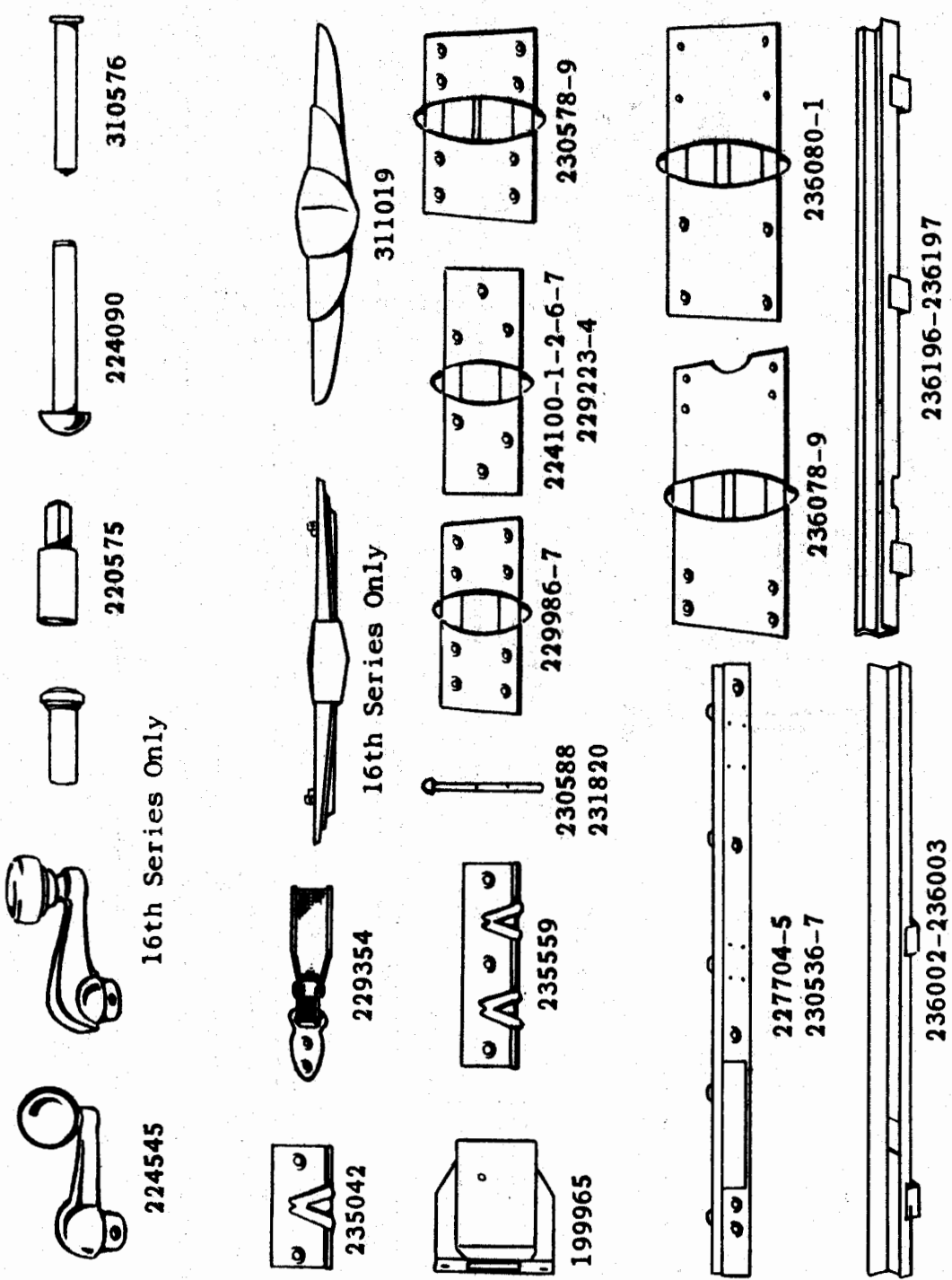

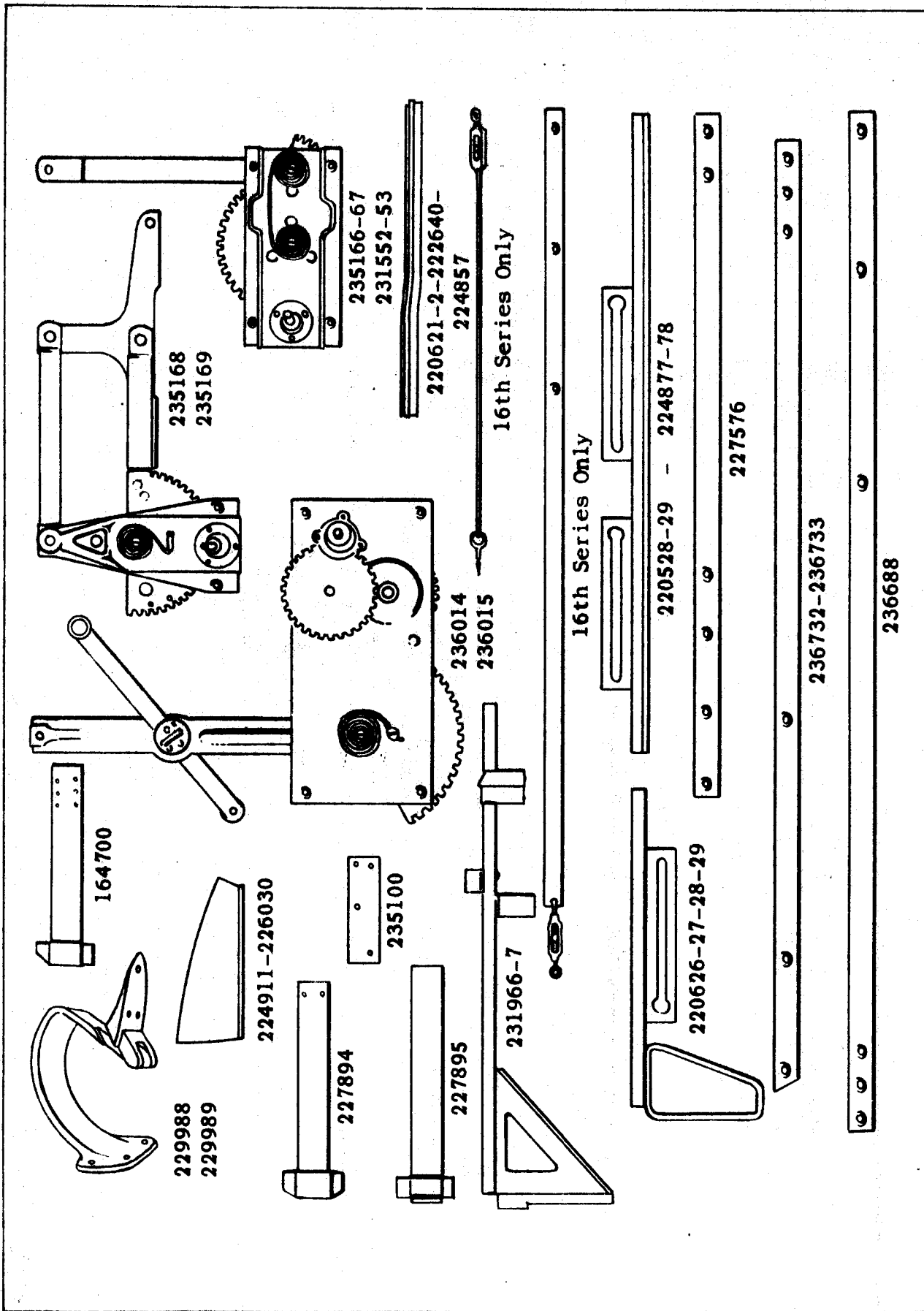







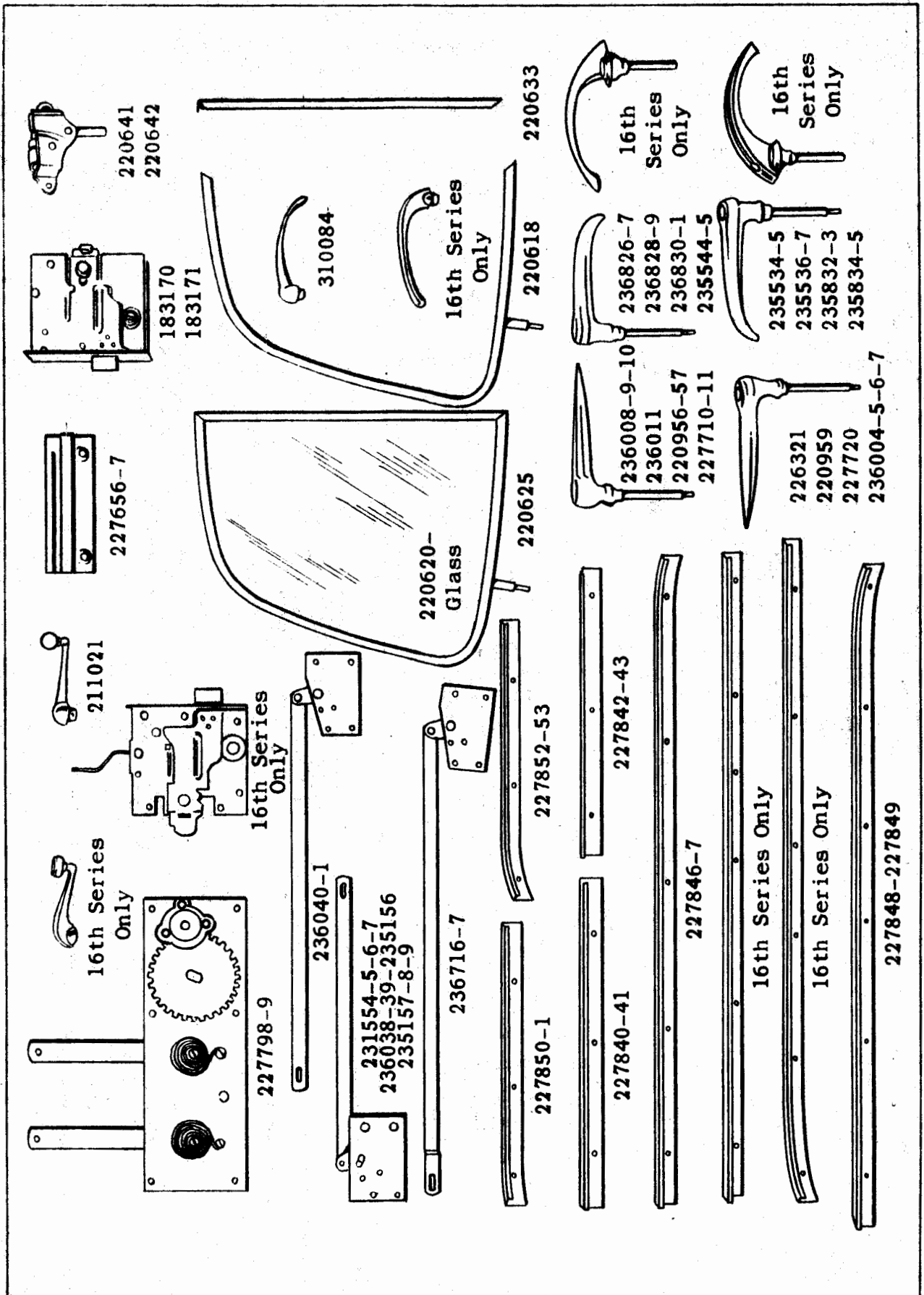



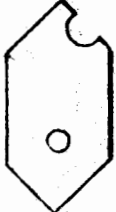



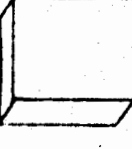
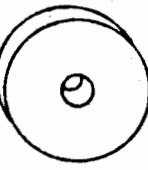

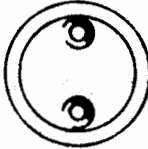





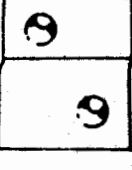

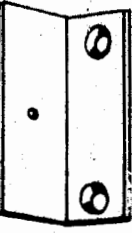
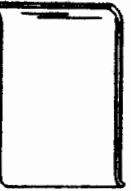

Piece No.	Name	(15th Series)									
		1012-32 5 P. Formal Sedan	1003-13-23-33 5 P. Tour. Sedan	1014-34 7 P. Tour. Sedan	1015-35 7 P. Tour. Sedan Lim.	1016-36 5 P. Club Sedan	1017-37 5 P. Coupe	1018-38 2-4 P. Coupe	1019-39 2-4 P. Conv. Coupe	1063-73 5 P. Conv. Sedan	1007-27 5 P. Victoria
		No. Required									
236181	Front door window finishing moulding--left (Used on 1073)	-	-	-	-	-	-	-	-	1	-
236018	Front door window finishing moulding--right (Used on 1019-1007)	-	-	-	-	-	-	-	1	-	1
236016	Front door window finishing moulding--right (Used on 1039-1027)	-	-	-	-	-	-	-	1	-	1
236019	Front door window finishing moulding--left (Used on 1019-1007)	-	-	-	-	-	-	-	1	-	1
236017	Front door window finishing moulding--left (Used on 1039-1027)	-	-	-	-	-	-	-	1	-	1
231766	Front door window finishing moulding--right (Used on 1023-1036)	-	1	-	-	1	-	-	-	-	-
231767	Front door window finishing moulding--left (Used on 1023-1036)	-	1	-	-	1	-	-	-	-	-
231568	Front door window finishing moulding--right (Used on 1032-1033-34-35-37)	1	1	1	1	-	1	-	-	-	-
231569	Front door window finishing moulding--left (Used on 1032-33-34-35-37)	1	1	1	1	-	1	-	-	-	-
231764	Front door window finishing moulding--right (Used on 1038)	-	-	-	-	-	-	1	-	-	-
231765	Front door window finishing moulding--left (Used on 1038)	-	-	-	-	-	-	1	-	-	-
218522	Front door window finishing moulding wood screw ferrule No. 6	x	x	x	x	x	x	x	x	x	x
228239	Front door window to folding top pillar weatherstrip (Black)	-	-	-	-	-	-	-	x	-	x
228238	Front door window to folding top pillar weatherstrip (Tan)	-	-	-	-	-	-	-	x	-	x
227852	Front door window to folding top pillar weatherstrip retainer--right	-	-	-	-	-	-	-	1	-	1
227853	Front door window to folding top pillar weatherstrip retainer--left	-	-	-	-	-	-	-	1	-	1
220624	Front door window glass (Used on 1003-23- 1016-36)	-	2	-	-	2	-	-	-	-	-
220634	Front door window glass (Used on 1012-13-14- 15-17-1032-1033-34-35-37)	2	2	2	2	-	2	-	-	-	-
228375	Front door window glass	-	-	-	-	-	-	2	-	-	-
236627	Front door window glass	-	-	-	-	-	-	-	-	2	-
227700	Front door window glass	-	-	-	-	-	-	-	2	-	2
0243914	Front door window glass cushion--bottom	-	-	-	-	-	-	-	1	1	1
0243915	Front door window glass cushion--upper	-	-	-	-	-	-	-	1	1	1
230590	Front door window glass and frame assembly-- right	-	-	-	-	-	-	-	1	-	1
230591	Front door window glass and frame assembly-- left	-	-	-	-	-	-	-	1	-	1
230555	Front door window glass and frame assembly belt anti-rattler	-	-	-	-	-	-	-	2	-	2
236636	Front door window glass and frame assembly-- right	-	-	-	-	-	-	-	-	1	-
236637	Front door window glass and frame assembly-- left	-	-	-	-	-	-	-	-	1	-
236001	Front door window glass and frame assembly belt anti-rattler	-	-	-	-	-	-	-	-	2	-
235453	Screw No. 6 x 3/4 flat hd. (Parker Kalon) Type A	-	-	-	-	-	-	-	16	-	-
0243910	Front door window glass frame--right	-	-	-	-	-	-	-	1	-	1

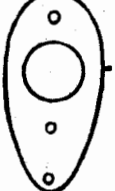
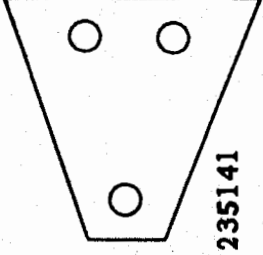
Piece No.	Name	(15th Series)										
		1012-32 5 P. Formal Sedan	1003-13-23-33 5 P. Tour. Sedan	1014-34 7 P. Tour. Sedan	1015-35 7 P. Tour. Sedan Lim.	1016-36 5 P. Club Sedan	1017-37 5 P. Coupe	1018-38 2-4 P. Coupe	1019-39 2-4 P. Conv. Coupe	1063-73 5 P. Conv. Sedan	1007-27 5 P. Victoria	
		No. Required										
0243911	Front door window glass frame--left	-	-	-	-	-	-	-	-	1	-	1
0243931	Front door window glass frame--right	-	-	-	-	-	-	-	-	-	1	1
0243932	Front door window glass frame--left	-	-	-	-	-	-	-	-	1	-	-
236002	Front door window glass frame guide--right	-	-	-	-	-	-	-	-	1	-	1
236196	Front door window glass frame guide--right	-	-	-	-	-	-	-	-	-	1	-
236003	Front door window glass frame guide--left	-	-	-	-	-	-	-	-	1	-	1
236197	Front door window glass frame guide--left	-	-	-	-	-	-	-	-	-	1	-
5701	Screw 1/4-28 x 9/16 flat hd.	-	-	-	-	-	-	-	-	6	6	6
228239	Front door window header weatherstrip (Black)	-	-	-	-	-	-	-	-	x	x	x
228238	Front door window header weatherstrip (Tan)	-	-	-	-	-	-	-	-	x	x	x
227848	Front door window header weatherstrip retainer--right	-	-	-	-	-	-	-	-	1	-	1
227849	Front door window header weatherstrip retainer--left	-	-	-	-	-	-	-	-	1	-	1
227844	Front door window header weatherstrip retainer--right	-	-	-	-	-	-	-	-	-	1	-
227845	Front door window header weatherstrip retainer--left	-	-	-	-	-	-	-	-	-	1	-
220626	Front door window lifter assembly--right (Used on 1003-23-16-36)	-	1	-	-	1	-	-	-	-	-	-
220627	Front door window lifter assembly--left (Used on 1003-23-16-36)	-	1	-	-	1	-	-	-	-	-	-
220628	Front door window lifter assembly--right (Not used on 1003-1023)	1	1	1	1	-	1	1	-	-	-	-
220629	Front door window lifter assembly--left (Not used on 1003-1023)	1	1	1	1	-	1	1	-	-	-	-
220622	Front door window lifter bumper (Used on 1003-23-1016-36)	-	2	-	-	2	-	-	-	-	-	-
220640	Front door window lifter bumper (Not used on 1003-23)	2	2	2	2	-	2	2	-	-	-	-
235166	Front door window regulator assembly--right (Used on 1003-23-1016-36)	-	1	-	-	1	-	-	-	-	-	-
235167	Front door window regulator assembly--left (Used on 1003-23-1016-36)	-	1	-	-	1	-	-	-	-	-	-
231552	Front door window regulator assembly--right (Not used on 1003-23)	1	1	1	1	-	1	1	-	-	-	-
231553	Front door window regulator assembly--left (Not used on 1003-23)	1	1	1	1	-	1	1	-	-	-	-
236014	Front door window regulator assembly--right	-	-	-	-	-	-	-	-	1	1	1
236015	Front door window regulator assembly--left	-	-	-	-	-	-	-	-	1	1	1
8214	Screw 1/4-28 x 3/4 flat head	8	8	8	8	8	8	8	-	-	-	-
6551	Screw 1/4-20 x 3/4 flat head	-	-	-	-	-	-	-	-	10	10	10
236012	Front door window regulator assembly to lock board washer	-	-	-	-	-	-	-	-	10	10	10
211021	Front door window regulator handle	2	2	2	2	2	2	2	2	2	2	2
211035	Front door window regulator handle escut- cheon plate	2	2	2	2	2	2	2	2	2	2	2
133264	Front door window regulator handle escut- cheon plate spring	2	2	2	2	2	2	2	2	2	2	2
133339	Front door window regulator handle insert	2	2	2	2	2	2	2	2	2	2	2
132972	Front door window regulator handle pin	2	2	2	2	2	2	2	2	2	2	2
227656	Front door window regulator lock board cam--right	-	-	-	-	-	-	-	-	1	1	1
227657	Front door window regulator lock board cam--left	-	-	-	-	-	-	-	-	1	1	1
220693	Front door window runway (front lower)	2	2	2	2	2	2	2	-	-	-	-

Piece No.	Name	(15th Series)									
		1012-32 5 P. Formal Sedan	1003-13-23-33 5 P. Tour. Sedan	1014-34 7 P. Tour. Sedan	1015-35 7 P. Tour. Sedan Lim	1016-36 5 P. Club Sedan	1017-37 5 P. Coupe	1018-38 2-4 P. Coupe	1019-39 2-4 P. Conv. Coupe	1063-73 5 P. Conv. Sedan	1007-27 5 P. Victoria
		No. Required									
175763	Screw No. 4 x 3/8 flat hd. (Parker Kalon)	4	4	4	4	4	4	4	-	-	-
220694	Front door window runway (front upper)	2	2	2	2	2	2	2	-	-	-
6347	Screw No. 8-32 x 1/4 flat hd.	4	4	4	4	4	4	4	-	-	-
220695	Front door window runway (rear lower)	2	2	2	2	2	2	2	-	-	-
220689	Front door window runway (rear upper) (Used on 1003-23-1016-36)	-	2	-	-	2	-	-	-	-	-
220698	Front door window runway (rear upper) (Not used on 1003-23)	2	2	2	2	-	2	-	-	-	-
228330	Front door window runway (rear upper)	-	-	-	-	-	-	2	-	-	-
231966	Front door window runway retainer assembly--front right	1	1	1	1	1	1	1	-	-	-
231967	Front door window runway retainer assembly--front left	1	1	1	1	1	1	1	-	-	-
163168	Front door window runway retainer--rear	2	2	2	2	2	2	2	-	-	-
136008	Front door window runway shim 1/32 x 1/2 x 40"	x	x	x	x	x	x	x	-	-	-
132429	Front door window runway shim 1/16 x 1/2 x 40"	x	x	x	x	x	x	x	-	-	-
131316	Front door window stop block bumper	2	2	2	2	2	2	2	-	-	-
227887	Front door window stop bumper	-	-	-	-	-	-	-	2	2	2
8224	Screw No. 10-32 x 5/8 flat head	-	-	-	-	-	-	-	2	-	-
227385	Front door window stop bumper bracket	-	-	-	-	-	-	-	2	2	2
228239	Front door window to windshield weather-strip (Black)	-	-	-	-	-	-	-	x	x	x
228238	Front door window to windshield weather-strip (Tan)	-	-	-	-	-	-	-	x	x	x
227840	Front door window to windshield weather-strip retainer--right	-	-	-	-	-	-	-	1	1	1
227841	Front door window to windshield weather-strip retainer--left	-	-	-	-	-	-	-	1	1	1
6460	Screw No. 8-32 x 3/8 flat head	-	-	-	-	-	-	-	8	8	8
220653	Front door window wing assembly--left	1	1	1	1	1	1	1	-	-	-
220652	Front door window wing assembly--right	1	1	1	1	1	1	1	-	-	-
227702	Front door window wing assembly--right	-	-	-	-	-	-	-	1	1	1
227703	Front door window wing assembly--left	-	-	-	-	-	-	-	1	1	1
6448	Screw 1/4-20 x 3/4 hex. head	4	4	4	4	4	4	4	-	-	-
5447	Lockwasher 1/4 (Shakeproof)	4	4	4	4	4	4	4	-	-	-
220620	Front door window wing glass	2	2	2	2	2	2	2	-	-	-
227701	Front door window wing glass	-	-	-	-	-	-	-	2	2	2
228272	Front door window wing glass cushion	x	x	x	x	x	x	x	-	-	-
211649	Front door window wing glass cushion	x	x	x	x	x	x	x	-	-	-
229324	Front door window wing glass cushion	x	x	x	x	x	x	x	-	-	-
0328868	Front door window wing glass and retainer assembly--right	-	-	-	-	-	-	-	1	1	1
0328867	Front door window wing glass and retainer assembly--left	-	-	-	-	-	-	-	1	1	1
220625	Front door window wing glass and retainer assembly	2	2	2	2	2	2	2	-	-	-
220618	Front door window wing glass retainer front assembly	2	2	2	2	2	2	2	-	-	-
220633	Front door window wing glass retainer rear assembly	2	2	2	2	2	2	2	-	-	-
212366	Front door window wing glass retainer screw No. 4 x 3/16 (Parker Kalon) Type Z special head	4	4	4	4	4	4	4	-	-	-



 16th Series Only	 164359	 227886	 308103 308102 310588	 227888	 131316
 199167	 227893	 227839	 211409	 235956	 307088
 133264	 185600-1-2 218685	 227887	 229996 229997	 16th Series Only	 227385
 227371	 227518 227519	 235046	 206188	 235434	 235141
 16th Series Only	 224544	 16th Series Only	 211035	 16th Series Only	 206187

Piece No.	Name	(15th Series)									
		1012-32 5 P. Formal Sedan	1003-13-23-33 5 P. Tour. Sedan	1014-34 7 P. Tour. Sedan	1015-35 7 P. Tour. Sedan Lim.	1016-36 5 P. Club Sedan	1017-37 5 P. Coupe	1018-38 2-4 P. Coupe	1019-39 2-4 P. Conv. Coupe	1063-73 5 P. Conv. Sedan	1007-27 5 P. Victoria
		No. Required									
199965	Rear door check strap guide assembly	2	2	2	2	2	-	-	-	-	-
227576	Rear door diagonal brace	-	-	-	-	-	-	-	-	2	-
235042	Rear door dovetail--female	2	2	2	2	2	-	-	-	-	-
235046	Rear door dovetail--male	2	2	2	2	2	-	-	-	2	-
224107	Rear door hinge lower--right	1	1	-	-	-	-	-	-	-	-
224106	Rear door hinge lower--left	1	1	-	-	-	-	-	-	-	-
224101	Rear door hinge lower--right	-	-	1	1	1	-	-	-	-	-
236078	Rear door hinge lower--right	-	-	-	-	-	-	-	-	1	-
224100	Rear door hinge lower--left	-	-	1	1	1	-	-	-	-	-
236079	Rear door hinge lower--left	-	-	-	-	-	-	-	-	1	-
224103	Rear door hinge upper--right	-	1	1	1	-	-	-	-	-	-
224102	Rear door hinge upper--left	-	1	1	1	-	-	-	-	-	-
229224	Rear door hinge upper--right	1	-	-	-	1	-	-	-	-	-
229223	Rear door hinge upper--left	1	-	-	-	1	-	-	-	-	-
236080	Rear door hinge upper--right	-	-	-	-	-	-	-	-	1	-
236081	Rear door hinge upper--left	-	-	-	-	-	-	-	-	1	-
5854	Rear door hinge screw 1/4-28 x 1-1/4 flat hd.	2	2	2	2	2	-	-	-	-	-
5747	Screw 1/4-28 x 1-5/8 flat hd.	2	2	2	2	2	-	-	-	-	-
5820	Screw 1/4-28 x 1-31/32 oval hd.	4	4	4	4	4	-	-	-	-	-
224090	Rear door hinge pin	4	4	4	4	4	-	-	-	-	-
230588	Rear door hinge pin	-	-	-	-	-	-	-	-	4	-
218600	Rear door hinge pin screw	4	4	4	4	4	-	-	-	-	-
5500	Lockwasher No. 10	4	4	4	4	4	-	-	-	-	-
183171	Rear door lock--right	1	1	1	1	1	-	-	-	-	-
183170	Rear door lock--right	-	-	-	-	-	-	-	-	1	-
183170	Rear door lock--left	1	1	1	1	1	-	-	-	-	-
183171	Rear door lock--left	-	-	-	-	-	-	-	-	1	-
5829	Screw No. 10-32 x 7/8 flat hd.	4	4	4	4	4	-	-	-	-	-
5491	Lockwasher 3/16 countersunk (Shakeproof)	4	4	4	4	4	-	-	-	-	-
227720	Rear door lock handle--right (With key lock) (Use with Partition) (straight)	-	-	-	-	-	-	-	-	1	-
220957	Rear door lock handle--right (straight)	-	1	1	-	1	-	-	-	-	-
227710	Rear door lock handle--right (straight)	-	-	-	-	-	-	-	-	1	-
220959	Rear door lock handle--right (With key lock) (straight) (L.H. drive)	1	-	-	1	-	-	-	-	-	-
220956	Rear door lock handle--left (straight) (L.H. drive)	1	1	1	1	1	-	-	-	-	-
227711	Rear door lock handle--left (straight)	-	-	-	-	-	-	-	-	1	-
235545	Rear door lock handle--right (curved)	-	1	1	-	1	-	-	-	-	-
235535	Rear door lock handle--right (Key lock) (curved) (L.H. drive)	1	-	-	1	-	-	-	-	-	-
235544	Rear door lock handle--left (curved) (L.H. drive)	1	1	1	1	1	-	-	-	-	-
236830	Rear door lock handle--right (curved)	-	-	-	-	-	-	-	-	1	-
236831	Rear door lock handle--left (curved) (L.H. drive)	-	-	-	-	-	-	-	-	1	-
236836	Rear door lock handle--right (Key lock) (curved) (Partition) (L.H. drive)	-	-	-	-	-	-	-	-	1	-
236837	Rear door lock handle--left (Key lock) (curved) (Partition) (R.H. drive)	-	-	-	-	-	-	-	-	1	-
235534	Rear door lock handle--left (Key lock) (curved) (R.H. drive)	1	-	-	1	-	-	-	-	-	-
235545	Rear door lock handle--right (curved) (R.H. drive)	1	-	-	1	-	-	-	-	-	-
226321	Rear door lock handle--left (Key lock) (straight) (R.H. drive)	1	-	-	1	-	-	-	-	-	-

Piece No.	Name	(15th Series)										No. Required
		1012-32 5 P. Formal Sedan	1003-13-23-33 5 P. Tour. Sedan	1014-34 7 P. Tour. Sedan	1015-35 7 P. Tour. Sedan Lim.	1016-36 5 P. Club Sedan	1017-37 5 P. Coupe	1018-38 2-4 P. Coupe	1019-39 2-4 P. Conv. Coupe	1063-73 5 P. Conv. Sedan	1007-27 5 P. Victoria	
220957	Rear door lock handle--right (straight) (R.H. drive)	1	-	-	1	-	-	-	-	-	-	-
206223	Rear door lock handle attaching plate	1	2	2	1	2	-	-	-	-	1	-
206188	Rear door lock handle attaching plate (for key lock handle)	1	-	-	1	-	-	-	-	-	-	-
307088	Rear door lock handle cylinder lock	1	-	-	1	-	-	-	-	-	-	-
206187	Rear door lock handle escutcheon plate	2	2	2	2	2	-	-	-	-	2	-
235434	Rear door lock handle escutcheon plate gasket	2	2	2	2	2	-	-	-	-	2	-
206043	Rear door lock handle screw (for key lock handle)	x	-	-	x	-	-	-	-	-	-	-
206017	Rear door lock handle screw (for key lock handle)	x	-	-	x	-	-	-	-	-	-	-
212168	Rear door lock handle screw (for key lock handle)	x	-	-	x	-	-	-	-	-	-	-
185236	Rear door lock handle screw washer (for key lock handle)	1	-	-	1	-	-	-	-	-	-	-
235156	Rear door lock remote control--right (Used on 1003-23-14-15-16-34-35-36)	-	1	1	1	1	-	-	-	-	-	-
235157	Rear door lock remote control--left (Used on 1003-23-14-15-16-34-35-36)	-	1	1	1	1	-	-	-	-	-	-
235158	Rear door lock remote control--right (Used on 1012-13-1032-33)	1	1	-	-	-	-	-	-	-	-	-
235159	Rear door lock remote control--left (Used on 1012-13-1032-33)	1	1	-	-	-	-	-	-	-	-	-
236038	Rear door lock remote control--right	-	-	-	-	-	-	-	-	-	1	-
236039	Rear door lock remote control--left	-	-	-	-	-	-	-	-	-	1	-
310084	Rear door lock remote control handle	2	2	2	2	2	-	-	-	-	2	-
211035	Rear door lock remote control handle escutcheon plate	2	2	2	2	2	-	-	-	-	2	-
133264	Rear door lock remote control handle escut- cheon plate spring	2	2	2	2	2	-	-	-	-	2	-
133339	Rear door lock remote control handle insert.	2	2	2	2	2	-	-	-	-	2	-
132972	Rear door lock remote control handle pin ...	2	2	2	2	2	-	-	-	-	2	-
229997	Rear door lock striker (Used on 1012-1003- 1013-14-15-16)	2	2	2	2	2	-	-	-	-	-	-
229996	Rear door lock striker (Used on 1032-1023- 1033-34-35-36-1063-1073)	2	2	2	2	2	-	-	-	-	2	-
231638	Rear door panel--right (Used on 1003-1023) .	-	1	-	-	-	-	-	-	-	-	-
231639	Rear door panel--left (Used on 1003-1023) ..	-	1	-	-	-	-	-	-	-	-	-
231864	Rear door panel--right	1	-	-	-	-	-	-	-	-	-	-
231865	Rear door panel--left	1	-	-	-	-	-	-	-	-	-	-
231866	Rear door panel--right (Used on 1013-1033) .	-	1	-	-	-	-	-	-	-	-	-
231867	Rear door panel--left (Used on 1013-1033) ..	-	1	-	-	-	-	-	-	-	-	-
231640	Rear door panel--right	-	-	1	1	-	-	-	-	-	-	-
231641	Rear door panel--left	-	-	1	1	-	-	-	-	-	-	-
231642	Rear door panel--right	-	-	-	-	1	-	-	-	-	-	-
236046	Rear door panel--right	-	-	-	-	-	-	-	-	-	1	-
231643	Rear door panel--left	-	-	-	-	1	-	-	-	-	-	-
236047	Rear door panel--left	-	-	-	-	-	-	-	-	-	1	-
227839	Rear door striker--door bottom	-	-	-	-	-	-	-	-	-	2	-
311019	Rear door trim panel moulding (Used on 1012- 1003-1013-14-15-16-1063)	2	2	2	2	2	-	-	-	-	2	-
235407	Rear door weatherstrip--front	2	2	2	2	2	-	-	-	-	-	-
235408	Rear door weatherstrip--rear	2	2	-	-	-	-	-	-	-	-	-
235403	Rear door weatherstrip--rear	-	-	2	2	-	-	-	-	-	-	-
235407	Rear door weatherstrip--rear	-	-	-	-	2	-	-	-	-	-	-

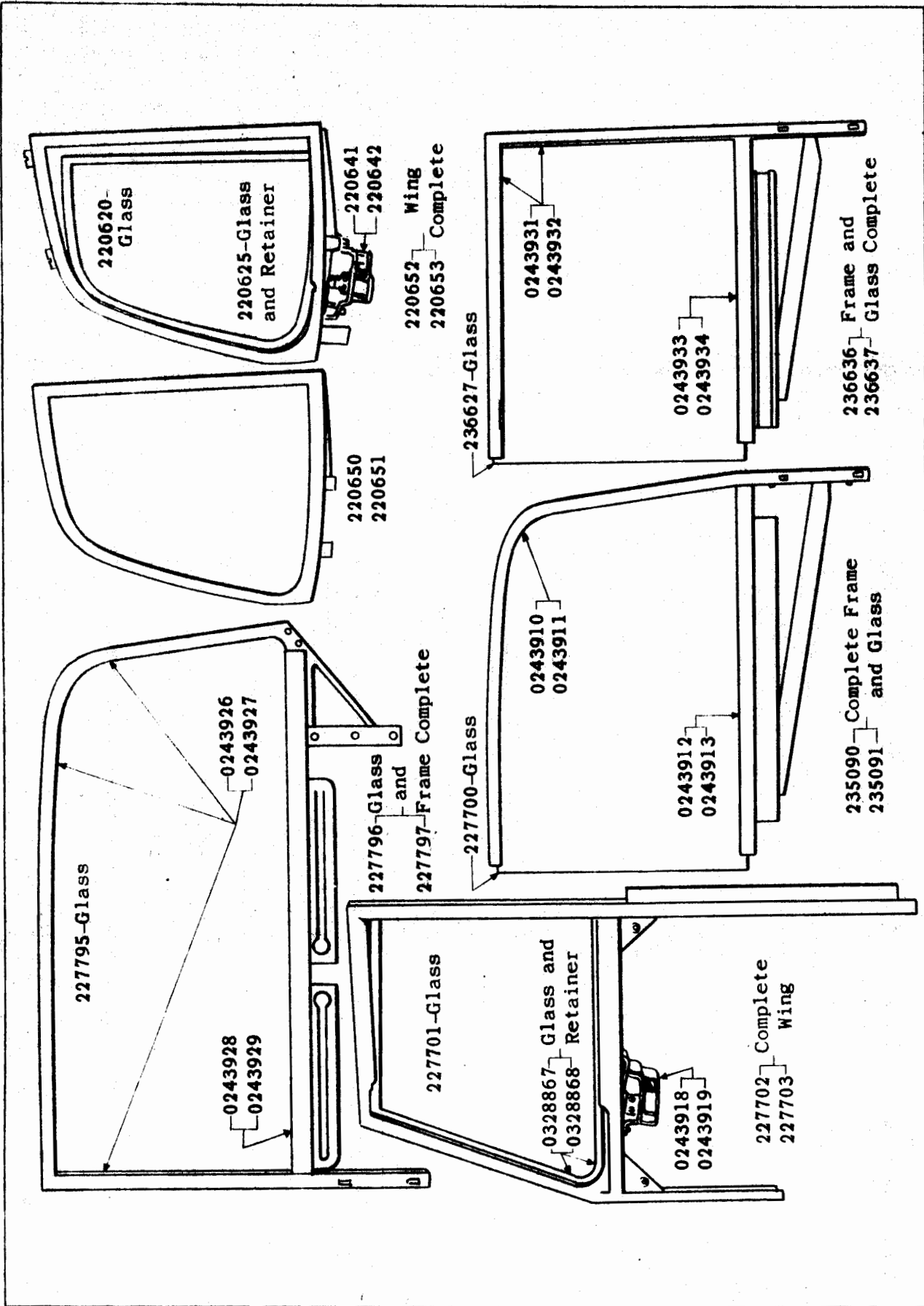

Piece No.	Name	(15th Series)										No. Required
		1012-32 5 P. Formal Sedan	1003-13-23-33 5 P. Tour. Sedan	1014-34 7 P. Tour. Sedan	1015-35 7 P. Tour. Sedan Lim.	1016-36 5 P. Club Sedan	1017-37 5 P. Coupe	1018-38 2-4 P. Coupe	1019-39 2-4 P. Conv. Coupe	1023-73 5 P. Conv. Sedan	1007-27 5 P. Victoria	
36111	Electrical-body feed cable terminal insulator	x	x	x	x	x	x	x	x	x	-	-
48202	Electrical-body ground cable terminal 1/4 eye	x	x	x	x	x	x	x	x	-	-	-
225377	Electrical-body ground cable terminal 11/64 eye	x	-	-	-	-	-	-	-	-	-	-
5873	Screw 1/4-28 x 9/16 hex. hd.	2	2	2	2	2	2	-	-	-	-	-
5502	Lockwasher 1/4	2	2	2	2	2	2	-	-	-	-	-
7004	Nut 1/4-28	2	2	2	2	2	2	-	-	-	-	-
167069	Electrical-body wiring cable (19 strand No. 16 Ga. Green Braid)	x	x	x	x	x	x	x	x	-	-	-
179251	Electrical-body wiring cable (19 strand No. 12 Ga. Green Braid)	x	x	x	x	x	x	-	-	-	-	-
166403	Electrical-body wiring cable (19 strand No. 12 Ga. Red Braid)	x	x	x	x	x	x	-	-	-	-	-
166406	Electrical-body wiring cable (19 strand No. 16 Ga. Red Braid)	x	x	x	x	x	x	x	x	-	-	-
166404	Electrical-body wiring cable (19 strand No. 16 Ga. Black Braid)	x	x	x	x	x	x	x	x	-	-	-
166405	Electrical-body wiring cable (19 strand No. 16 Ga. Black with Red Tracer Braid) ..	x	x	x	x	x	x	x	x	-	-	-
194286	Electrical-body wiring cable clip (Used on 1032-1023-1033-34-35-36-37-38-39)	2	2	2	2	2	2	2	2	-	-	-
201736	Electrical-body wiring cable connector tip male	x	x	x	x	x	x	x	x	-	-	-
224442	Electrical-body wiring cable groove clip ...	x	x	x	x	x	-	-	-	-	-	-
29254	Electrical-body wiring cable staple insulated No. 1 x 1/2	x	x	x	x	x	x	x	x	-	-	-
33287	Electrical-body wiring dome light cable terminal 13/64 eye	5	2	2	2	2	2	2	-	-	-	-
36111	Electrical-body wiring dome light cable terminal insulator	5	2	2	5	2	2	2	-	-	-	-
201710	Electrical-dictograph receiver to body fuse cable terminal 11/64 eye	-	-	-	1	-	-	-	-	-	-	-
36111	Electrical-dictograph receiver to body fuse cable terminal insulator	-	-	-	1	-	-	-	-	-	-	-
211003	Electrical-dictograph transmitter and winder assembly	-	-	-	1	-	-	-	-	-	-	-
133004	Electrical-dictograph winder	-	-	-	1	-	-	-	-	-	-	-
5696	Screw No. 8-32 x 3/8 rnd. hd.	-	-	-	2	-	-	-	-	-	-	-
5695	Lockwasher No. 8	-	-	-	2	-	-	-	-	-	-	-
7002	Nut No. 8-32	-	-	-	2	-	-	-	-	-	-	-
224265	Electrical-dictograph winder bracket	-	-	-	1	-	-	-	-	-	-	-
5853	Screw 1/4-28 x 1/2 rnd. hd.	-	-	-	1	-	-	-	-	-	-	-
5502	Lockwasher 1/4	-	-	-	1	-	-	-	-	-	-	-
7004	Nut 1/4-28	-	-	-	1	-	-	-	-	-	-	-
229866	Electrical-dictograph receiver	-	-	-	1	-	-	-	-	-	-	-
235423	Electrical-dictograph receiver support bracket--front	-	-	-	1	-	-	-	-	-	-	-
229865	Electrical-dictograph receiver support bracket--rear	-	-	-	1	-	-	-	-	-	-	-
5580	Screw No. 10-32 x 1 flat hd.	-	-	-	2	-	-	-	-	-	-	-
5870	Screw No. 10-32 x 1/2 round hd.	-	-	-	2	-	-	-	-	-	-	-
5500	Lockwasher No. 10	-	-	-	4	-	-	-	-	-	-	-
3866	Washer 3/16	-	-	-	2	-	-	-	-	-	-	-
7003	Nut No. 10-32	-	-	-	4	-	-	-	-	-	-	-

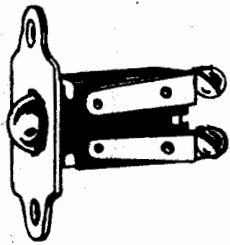

220761

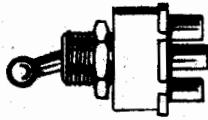

240390
240391

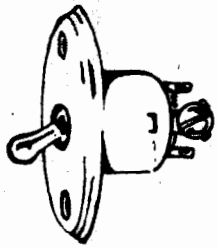

224550-224554

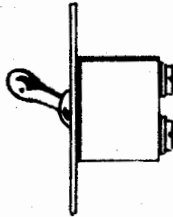

136593

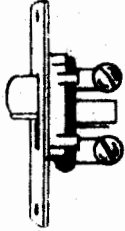

16th Series
Only



224559



224597



16th Series
Only



16th Series
Only

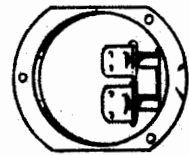

235175



235162



235160
235155



183836



235423



229865



224265



133004

211004

211003-Complete

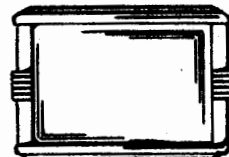

16th Series
Only

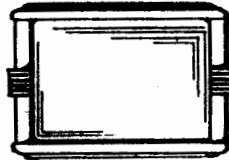

16th Series
Only



235126

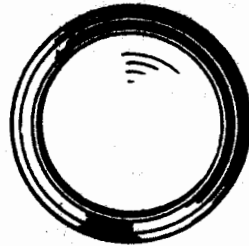

235124
235125

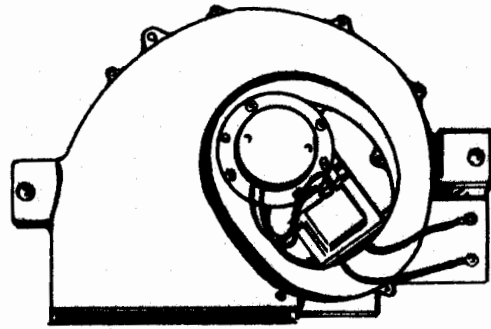

229866

Piece No.	Name (15th Series)	No. Required									
		1012-32 5 P. Formal Sedan	1003-13-23-33 5 P. Tour. Sedan	1014-34 7 P. Tour. Sedan	1015-35 7 P. Tour. Sedan Lim	1016-36 5 P. Club Sedan	1017-37 5 P. Coupe	1018-38 2-4 P. Coupe	1019-39 2-4 P. Conv. Coupe	1063-73 5 P. Conv. Sedan	1007-27 5 P. Victoria
FLOOR											
231711	Floor-battery cover assembly	1	1	1	1	1	1	1	1	1	1
231713	Floor-battery cover fastener	1	1	1	1	1	1	1	1	1	1
305880	Floor-battery cover fastener rivet	1	1	1	1	1	1	1	1	1	1
231687	Floor-battery cover fastener striker plate .	1	1	1	1	1	1	1	1	1	1
231715	Floor-battery cover weatherstrip	1	1	1	1	1	1	1	1	1	1
231818	Floor-board (front) assembly (Used on 1012- 1003-13-14-15-16-17-18-19-1063-1007)	1	1	1	1	1	1	1	1	1	1
235354	Floor-board (front) assembly (Used on 1032- 23-33-34-35-36-37-38-39-1073-1027)	1	1	1	1	1	1	1	1	1	1
231632	Floor-board (rear) assembly	1	1	1	1	-	-	-	-	1	-
185832	Floor-board (front) washer	4	4	4	4	4	4	4	4	4	4
7906	Screw 1/4-28 x 3/4 round head	2	2	2	2	2	2	2	2	2	2
5502	Lockwasher 1/4	2	2	2	2	2	2	2	2	2	2
235355	Floor-board (front) hole cover assembly	1	1	1	1	1	1	1	1	1	1
231631	Floor-board (rear) cutout plate	1	1	1	1	1	1	1	1	1	-
235349	Floor-carpet (front) heel pad (Used on 1012- 1003-13-14-15-16-17-18-19)	1	1	1	1	1	1	1	1	-	-
231526	Floor-door scuff plate front lower--right (Used on 1003-1016)	-	1	-	-	1	-	-	-	-	-
231527	Floor-door scuff plate front lower--left (Used on 1003-1016)	-	1	-	-	1	-	-	-	-	-
231740	Floor-door scuff plate front lower--right (Used on 1012-13-14-15-1063-1007)	1	1	1	1	-	-	-	-	1	1
231741	Floor-door scuff plate front lower--left (Used on 1012-13-14-15-1063-1007)	1	1	1	1	-	-	-	-	1	1
231736	Floor-door scuff plate front lower--right (Used on 1017-18)	-	-	-	-	-	1	1	-	-	-
231737	Floor-door scuff plate front lower--left (Used on 1017-18)	-	-	-	-	-	1	1	-	-	-
231742	Floor-door scuff plate front lower--right (Used on 1032-33-34-35-1019-39-1073-27) ..	1	1	1	1	-	-	-	1	1	1
231743	Floor-door scuff plate front lower--left (Used on 1032-33-34-35-1019-39-1073-27) ..	1	1	1	1	-	-	-	1	1	1
231746	Floor-door scuff plate front lower--right (Used on 1023-1036)	-	1	-	-	1	-	-	-	-	-
231747	Floor-door scuff plate front lower--left (Used on 1023-1036)	-	1	-	-	1	-	-	-	-	-
231738	Floor-door scuff plate front lower--right (Used on 1037-38)	-	-	-	-	-	1	1	-	-	-
231739	Floor-door scuff plate front lower--left (Used on 1037-38)	-	-	-	-	-	1	1	-	-	-
231528	Floor-door scuff plate front upper--right (Used on 1003-23-1016-36)	-	1	-	-	1	-	-	-	-	-
231529	Floor-door scuff plate front upper--left (Used on 1003-23-1016-36)	-	1	-	-	1	-	-	-	-	-
231744	Floor-door scuff plate front upper--right (Used on 1012-32-13-33-14-34-15-35-17-37- 18-38)	1	1	1	1	-	1	1	-	-	-
231745	Floor-door scuff plate front upper--left (Used on 1012-32-13-33-14-34-15-35-17-37- 18-38)	1	1	1	1	-	1	1	-	-	-
236026	Floor-door scuff plate front upper--right ..	-	-	-	-	-	-	-	1	-	1
236686	Floor-door scuff plate front upper--right ..	-	-	-	-	-	-	-	-	1	-
236027	Floor-door scuff plate front upper--left ...	-	-	-	-	-	-	-	1	-	1



16th Series
Only

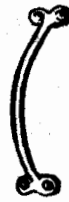

211539



185114

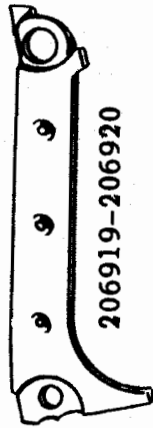

206919-206920



100100

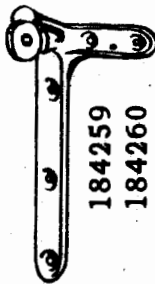

184259
184260

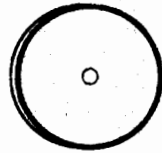

235355



224286-7 - 224305-6-7-8

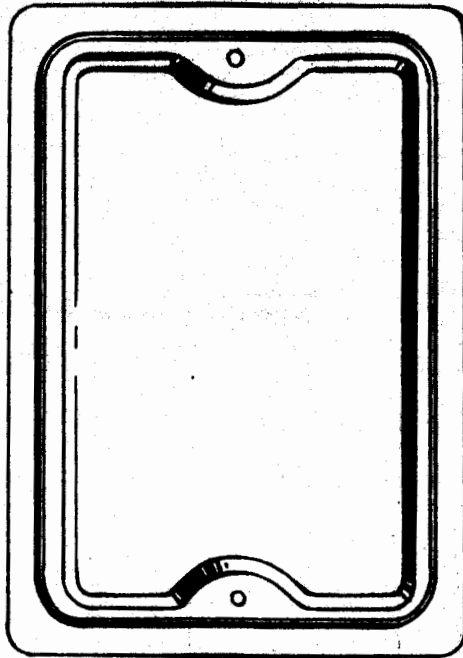

231711



231526-7 - 231740-1-2-3-6-7 - 231736-7-8-9

Piece No.	(15th Series) Name	No. Required										
		1012-32 5 P. Formal Sedan	1003-13-23-33 5 P. Tour. Sedan	1014-34 7 P. Tour. Sedan	1015-35 7 P. Tour. Sedan Lim.	1016-36 5 P. Club Sedan	1017-37 5 P. Coupe	1018-38 2-4 P. Coupe	1019-39 2-4 P. Conv. Coupe	1083-73 5 P. Conv. Sedan	1007-27 5 P. Victoria	
236687	Floor-door scuff plate front upper--left ...	-	-	-	-	-	-	-	-	-	1	-
224286	Floor-door scuff plate rear lower (Used on 1012-1003-1013)	2	2	-	-	-	-	-	-	-	-	-
224287	Floor-door scuff plate rear lower (Used on 1032-1023-1033)	2	2	-	-	-	-	-	-	-	-	-
224305	Floor-door scuff plate rear lower--right (Used on 1014-15-16-1063)	-	-	1	1	1	-	-	-	1	-	-
224306	Floor-door scuff plate rear lower--left (Used on 1014-15-16-1063)	-	-	1	1	1	-	-	-	1	-	-
224307	Floor-door scuff plate rear lower--right (Used on 1034-35-36-1073)	-	-	1	1	1	-	-	-	1	-	-
224308	Floor-door scuff plate rear lower--left (Used on 1034-35-36-1073)	-	-	1	1	1	-	-	-	1	-	-
224403	Floor-door scuff plate rear upper--right (Used on 1003-1023)	-	1	-	-	-	-	-	-	-	-	-
224404	Floor-door scuff plate rear upper--left (Used on 1003-1023)	-	1	-	-	-	-	-	-	-	-	-
226262	Floor-door scuff plate rear upper--right (Used on 1012-32-1013-33)	1	1	-	-	-	-	-	-	-	-	-
226261	Floor-door scuff plate rear upper--left (Used on 1012-32-1013-33)	1	1	-	-	-	-	-	-	-	-	-
224407	Floor-door scuff plate rear upper--right ...	-	-	1	1	1	-	-	-	-	-	-
227738	Floor-door scuff plate rear upper--right ...	-	-	-	-	-	-	-	-	1	-	-
224408	Floor-door scuff plate rear upper--left	-	-	1	1	1	-	-	-	-	-	-
227739	Floor-door scuff plate rear upper--left	-	-	-	-	-	-	-	-	1	-	-
231635	Floor-rear seat pan and side sill assembly .	1	1	1	1	-	-	-	-	-	-	-
231758	Floor-rear seat pan and side sill assembly .	-	-	-	-	1	-	-	-	-	-	-
235061	Floor-rear seat pan and side sill assembly .	-	-	-	-	-	1	-	-	-	-	-
231756	Floor-rear seat pan and side sill assembly .	-	-	-	-	-	-	1	1	-	-	-

FOLDING SEAT

Always send samples of material when ordering trimmed assemblies, as the assemblies are upholstered to match the body interior.

233112	Folding seat trimmed assembly (Used on 1014)	-	-	2	-	-	-	-	-	-	-	-
233113	Folding seat trimmed assembly (Used on 1034)	-	-	2	-	-	-	-	-	-	-	-
233386	Folding seat trimmed assembly (Used on 1015)	-	-	-	2	-	-	-	-	-	-	-
233387	Folding seat trimmed assembly (Used on 1035)	-	-	-	2	-	-	-	-	-	-	-
226263	Folding seat trimmed assembly	1	-	-	-	-	-	-	-	-	-	-
184270	Folding seat untrimmed assembly	1	-	-	-	-	-	-	-	-	-	-
224065	Folding seat untrimmed assembly	-	-	2	2	-	-	-	-	-	-	-
224154	Folding seat back untrimmed assembly	-	-	2	2	-	-	-	-	-	-	-
184853	Folding seat back untrimmed assembly	1	-	-	-	-	-	-	-	-	-	-
184260	Folding seat back bracket--right	1	-	-	-	-	-	-	-	-	-	-
184259	Folding seat back bracket--left	1	-	-	-	-	-	-	-	-	-	-
185113	Folding seat back to seat frame screw	-	-	4	4	-	-	-	-	-	-	-
184268	Folding seat back to seat frame screw	2	-	-	-	-	-	-	-	-	-	-
184682	Folding seat cushion pad	1	-	-	-	-	-	-	-	-	-	-
311191	Folding seat cushion pad	-	-	2	-	-	-	-	-	-	-	-
172294	Folding seat cushion spring	-	-	-	2	-	-	-	-	-	-	-
231991	Folding seat floor plate assembly	-	-	1	1	-	-	-	-	-	-	-
224064	Folding seat frame assembly	-	-	2	2	-	-	-	-	-	-	-
5580	Screw No. 10-32 x 1 flat hd.	-	-	16	16	-	-	-	-	-	-	-

Piece No.	Name	(15th Series)										
		1012-32 S.P. Formal Sedan	1003-13-23-33 S.P. Tour. Sedan	1014-34 7 P. Tour. Sedan	1015-35 7 P. Tour. Sedan Lim.	1016-36 S.P. Club Sedan	1017-37 S.P. Coupe	1018-38 2-4 P. Coupe	1019-39 2-4 P. Conv. Coupe	1063-73 S.P. Conv. Sedan	1007-27 S.P. Victoria	No. Required
5229	Screw 1/4-28 x 1-3/8 flat hd.	-	-	8	8	-	-	-	-	-	-	-
8220	Screw 1/4-28 x 1-1/2 flat hd.	-	-	8	8	-	-	-	-	-	-	-
7003	Nut No. 10-32	-	-	16	16	-	-	-	-	-	-	-
7004	Nut 1/4-28	-	-	16	16	-	-	-	-	-	-	-
3867	Washer 3/16 special	-	-	4	4	-	-	-	-	-	-	-
185118	Folding seat frame side--right	-	-	2	2	-	-	-	-	-	-	-
185111	Folding seat frame side--left	-	-	2	2	-	-	-	-	-	-	-
211539	Folding seat handle	1	-	2	2	-	-	-	-	-	-	-
100100	Folding seat pivot pin	-	-	4	4	-	-	-	-	-	-	-
184851	Folding seat support right assembly	1	-	-	-	-	-	-	-	-	-	-
184852	Folding seat support left assembly	1	-	-	-	-	-	-	-	-	-	-
206920	Folding seat support--right	-	-	2	2	-	-	-	-	-	-	-
206919	Folding seat support--left	-	-	2	2	-	-	-	-	-	-	-
185114	Folding seat support to seat frame screw ...	-	-	4	4	-	-	-	-	-	-	-
7006	Nut 3/8-24	-	-	4	4	-	-	-	-	-	-	-
5506	Lockwasher 3/8	-	-	4	4	-	-	-	-	-	-	-

FOOT REST

224562	Foot rest assembly (Specify set number) (Used on 1023-33-34-35)	-	1	1	1	-	-	-	-	-	-	-
224563	Foot rest assembly (Specify set number) (Used on 1003-13-14-15) (Use with woolen carpet)	-	1	1	1	-	-	-	-	-	-	-
233555	Foot rest assembly (Specify set number) (Used on 1003-13-14-15) (Use with mohair carpet)	-	1	1	1	-	-	-	-	-	-	-
79574	Foot rest assembly	-	-	-	-	-	-	1	1	-	-	-
206134	Foot rest bar cushion (Used on 1023-33- 34-35)	-	1	1	1	-	-	-	-	-	-	-
224555	Foot rest bar end bracket--right (Used on 1023-33-34-35)	-	1	1	1	-	-	-	-	-	-	-
224556	Foot rest bar end bracket--left (Used on 1023-33-34-35)	-	1	1	1	-	-	-	-	-	-	-
224534	Foot rest bar end to support screw (Used on 1023-33-34-35)	-	2	2	2	-	-	-	-	-	-	-
195201	Foot rest bar end to support screw washer (Used on 1023-33-34-35)	-	2	2	2	-	-	-	-	-	-	-
6048	Lockwasher 3/8 (Shakeproof) (Used on 1023-33-34-35)	-	2	2	2	-	-	-	-	-	-	-
122146	Foot rest pivot stud	-	-	-	-	-	-	-	2	2	-	-
180134	Foot rest pivot stud nut--blind	-	-	-	-	-	-	-	2	2	-	-
224548	Foot rest support--right (Used on 1003-13- 14-15-1063)	-	1	1	1	-	-	-	-	-	1	-
224549	Foot rest support--left (Used on 1003-13-14- 15-1063)	-	1	1	1	-	-	-	-	-	1	-
224574	Foot rest support bracket (Used on 1023-33- 34-35)	-	2	2	2	-	-	-	-	-	-	-
224573	Foot rest support bracket (Used on 1003-13- 14-15-1063)	-	2	2	2	-	-	-	-	-	2	-
147114	Foot rest support bracket	-	-	-	-	-	-	-	2	2	-	-
8013	Screw No. 10-32 x 1-1/8 O.H.	-	4	4	4	-	-	-	-	-	-	-
224537	Foot rest to support bracket screw	-	2	2	2	-	-	-	-	-	-	-

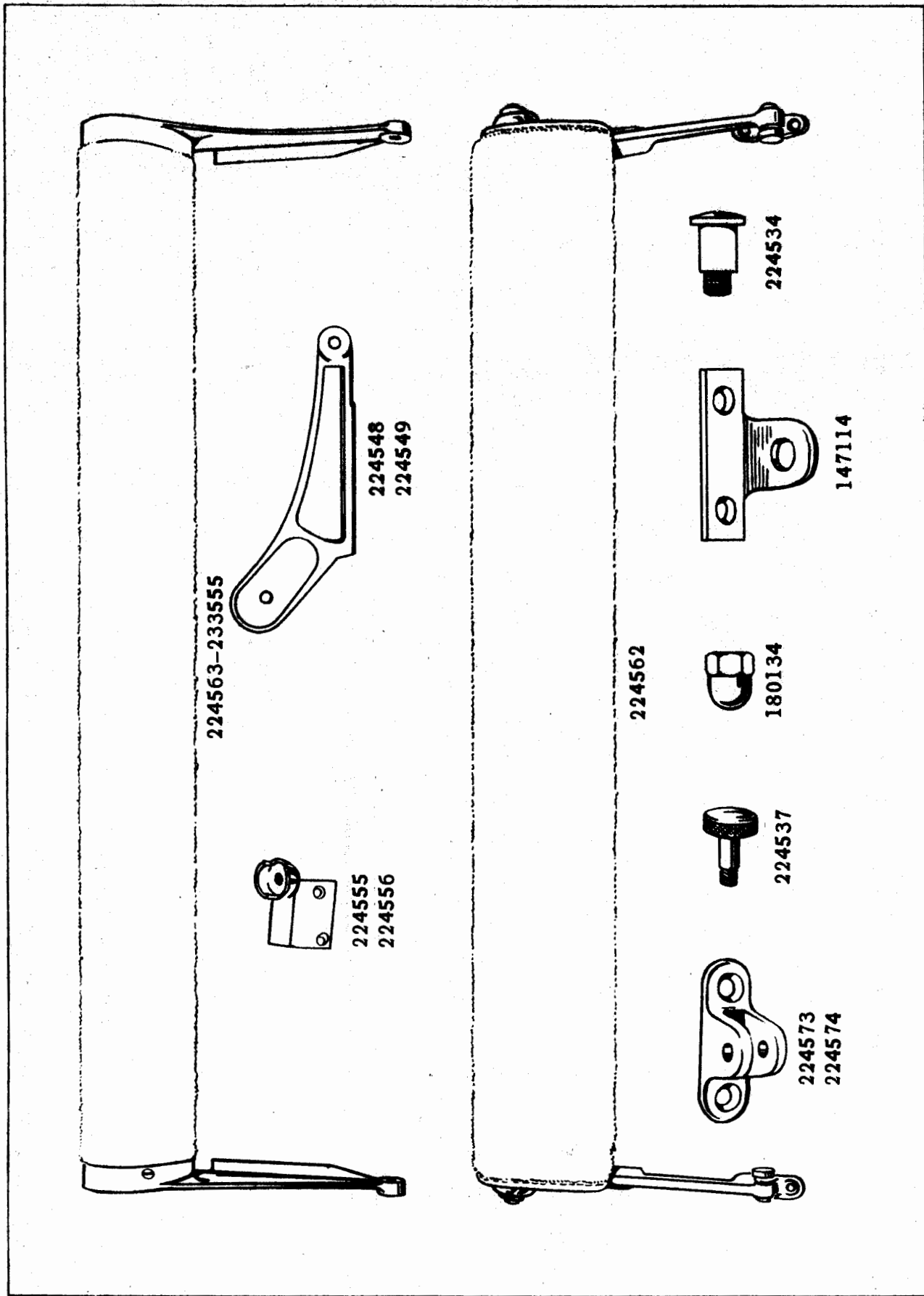

Piece No.	Name	(15th Series)									
		1012-32 5 P. Formal Sedan	1003-13-23-33 5 P. Tour. Sedan	1014-34 7 P. Tour. Sedan	1015-35 7 P. Tour. Sedan Lim.	1016-36 5 P. Club Sedan	1017-37 5 P. Coupe	1018-38 2-4 P. Coupe	1019-39 2-4 P. Conv. Coupe	1063-73 5 P. Conv. Sedan	1007-27 5 P. Victoria
		No. Required									
206130	Foot rest support bracket cushion (Not used on 1073)	-	2	2	2	-	-	-	-	2	-
206132	Foot rest support cushion (Used on 1023-33-34-35)	-	2	2	2	-	-	-	-	-	-
FRONT END											
224150	Front end-body to frame bolt bracket--liner 2 x 13-1/2	2	2	2	2	2	2	2	2	-	-
229932	Front end-panel assembly	-	1	1	1	1	1	1	-	-	-
236033	Front end-panel assembly	-	-	-	-	-	-	-	1	1	1
231519	Front end-panel assembly	1	-	-	-	-	-	-	-	-	-
231660	Front end-toe board bracket and support plate assembly--right	1	1	1	1	1	1	1	1	1	1
231661	Front end-toe board bracket and support plate assembly--left	1	1	1	1	1	1	1	1	1	1
6523	Bolt 1/4-28 x 3-5/8 carriage	4	4	4	4	4	4	4	4	-	-
6125	Bolt 5/16-24 x 2 step head	6	6	6	6	6	6	6	6	6	6
5449	Screw 5/16-24 x 3/4 hex. hd.	12	12	12	12	12	12	12	12	12	12
228237	Front end-toe board bracket and support plate assembly screw 5/16-24 x 2 flat hd..	4	4	4	4	4	4	4	4	4	4
7005	Nut 5/16-24	20	20	20	20	20	20	20	20	20	20
7004	Nut 1/4-28	4	4	4	4	4	4	4	4	4	4
5502	Lockwasher 1/4	4	4	4	4	4	4	4	4	4	4
5504	Lockwasher 5/16	18	18	18	18	18	18	18	18	18	18
6070	Lockwasher 5/16 (Shakeproof) (Woodtype)	2	2	2	2	2	2	2	2	2	2
FRONT SEAT											
6711	Front seat assembly to track screw 5/16-18 x 1/2 flat hd.	-	4	4	-	4	4	-	-	-	4
6527	Lockwasher 5/16 countersunk (Shakeproof)	-	4	4	-	4	4	-	-	-	4
227900	Front seat back compartment lid hinge	-	-	-	-	-	-	-	-	3	-
227899	Front seat back compartment lid lock and striker	-	-	-	-	-	-	-	-	1	-
310404	Front seat back pivot screw	-	-	-	-	-	3	-	-	-	3
6044	Lockwasher 5/16 (Shakeproof)	-	-	-	-	-	2	-	-	-	-
310405	Front seat back pivot screw nut	-	-	-	-	-	1	-	-	-	1
3883	Front seat back pivot screw spacer washer-- center 7/16	-	-	-	-	-	2	-	-	-	2
6614	Washer--center 7/16	-	-	-	-	-	1	-	-	-	1
220979	Front seat back spring	-	-	-	1	-	-	-	-	-	-
226037	Front seat back spring	1	-	-	-	-	-	-	-	-	-
*231558	Front seat back spring	-	1	1	-	1	1	-	-	-	-
*235363	Front seat back spring--left	-	-	-	-	-	1	-	-	-	-
*235362	Front seat back spring--right	-	-	-	-	-	1	-	-	-	-

*These cancelled springs are held in place by spring clips welded to the top of the seat.

Piece No.	Name	(15th Series)										
		1012-32 5 P. Formal Sedan	1003-13-23-33 5 P. Tour. Sedan	1014-34 7 P. Tour. Sedan	1015-35 7 P. Tour. Sedan Lim.	1016-36 5 P. Club Sedan	1017-37 5 P. Coupe	1018-38 2-4 P. Coupe	1019-39 2-4 P. Conv. Coupe	1063-73 5 P. Conv. Sedan	1007-27 5 P. Victoria	
		No. Required										
233047	Front seat (right) cushion (trimmed) assembly (Used on 1039)	-	-	-	-	-	-	-	-	1	-	-
224637	Front seat (right) cushion (trimmed) assembly (Used on 1018) (L.H. drive)	-	-	-	-	-	-	1	-	-	-	-
228168	Front seat (right) cushion (trimmed) assembly (Used on 1019) (L.H. drive)	-	-	-	-	-	-	-	1	-	-	-
228091	Front seat (left) cushion (trimmed) assembly (R.H. drive)	-	-	-	-	-	-	-	1	-	-	-
228175	Front seat (left) cushion (trimmed) assembly (R.H. drive)	-	-	-	-	-	-	-	1	-	-	-
228090	Front seat (right) cushion (trimmed) assembly (R.H. drive)	-	-	-	-	-	-	-	1	-	-	-
228174	Front seat (right) cushion (trimmed) assembly (R.H. drive)	-	-	-	-	-	-	-	1	-	-	-
220977	Front seat cushion spring	1	-	-	1	-	-	-	-	-	-	-
231559	Front seat cushion spring	-	1	1	-	1	-	-	-	-	-	-
224130	Front seat (right) cushion spring (L.H. drive)	-	-	-	-	-	-	1	-	-	-	-
236786	Front seat (right) cushion spring	-	-	-	-	-	-	-	-	1	-	-
228061	Front seat (right) cushion spring (L.H. drive)	-	-	-	-	-	-	-	-	1	-	-
228154	Front seat (left) cushion spring (L.H. drive)	-	-	-	-	-	-	-	-	1	-	-
236787	Front seat (left) cushion spring	-	-	-	-	-	-	-	-	-	1	-
224131	Front seat (left) cushion spring (L.H. drive)	-	-	-	-	-	-	-	1	-	-	-
228063	Front seat (right) cushion spring (L.H. drive)	-	-	-	-	-	-	-	1	-	-	-
228130	Front seat (right) cushion spring (R.H. drive)	-	-	-	-	-	-	-	1	-	-	-
228064	Front seat (left) cushion spring (R.H. drive)	-	-	-	-	-	-	-	1	-	-	-
228181	Front seat (left) cushion spring (R.H. drive)	-	-	-	-	-	-	-	1	-	-	-
235365	Front seat cushion spring (R.H. drive)	-	-	-	-	-	-	1	-	-	-	-
235364	Front seat cushion spring (L.H. drive)	-	-	-	-	-	-	1	-	-	-	-
236746	Front seat cushion spring	-	-	-	-	-	-	-	-	-	-	1
310425	Front seat operating button	-	-	-	-	-	-	1	-	-	-	1
310655	Front seat operating button and link assembly (L.H. drive)	-	-	-	-	-	-	1	-	-	-	1
310654	Front seat operating button and link assembly (R.H. drive)	-	-	-	-	-	-	1	-	-	-	-
310067	Front seat operating button and rod assembly	-	1	1	-	1	-	-	-	-	-	-
4280	Pin 1/16 x 1/2 spring cotter	-	1	1	-	1	-	-	-	-	-	-
224303	Front seat left operating button rod and cable assembly (L.H. drive)	-	-	-	-	-	-	-	1	-	-	-
226787	Front seat (left) operating button rod and cable assembly (L.H. drive)	-	-	-	-	-	-	-	-	1	-	-
227631	Front seat (left) operating button rod and cable assembly (L.H. drive)	-	-	-	-	-	-	-	-	-	1	-
226749	Front seat (right) operating button rod and cable assembly (R.H. drive)	-	-	-	-	-	-	-	1	-	-	-
226788	Front seat (right) operating button rod and cable assembly (R.H. drive)	-	-	-	-	-	-	-	-	1	-	-
227927	Front seat (right) operating button rod and cable assembly (R.H. drive)	-	-	-	-	-	-	-	-	-	1	-
7901	Screw No. 10-32 x 5/8 rnd. hd.	-	-	-	-	-	-	1	1	1	1	-
220797	Front seat (left) operating button finishing plate (L.H. drive)	-	-	-	-	-	-	-	1	1	1	-
310427	Front seat operating button finishing plate (L.H. drive)	-	-	-	-	-	-	1	-	-	-	1
310426	Front seat operating button finishing plate.	-	-	-	-	-	-	1	-	-	-	1
226333	Front seat operating button finishing plate.	-	-	-	-	-	-	1	1	1	1	-
310066	Front seat operating button finishing plate.	-	1	1	-	1	-	-	-	-	-	-

Piece No.	Name	(15th Series)									
		1012-32 5 P. Formal Sedan	1003-13-23-33 5 P. Tour. Sedan	1014-34 7 P. Tour. Sedan	1015-35 7 P. Tour. Sedan Lim.	1016-36 5 P. Club Sedan	1017-37 5 P. Coupe	1018-38 2-4 P. Coupe	1019-39 2-4 P. Conv. Coupe	1063-73 5 P. Conv. Sedan	1007-27 5 P. Victoria
		No. Required									
308802	Front seat operating button finishing plate screw No. 6 x 3/8 binding hd. (Parker Kalon)	-	-	-	-	-	1	-	-	-	1
6613	Screw No. 8 x 3/8 oval hd. (Parker Kalon)	-	2	2	-	2	-	-	-	-	-
310639	Front seat operating button link	-	-	-	-	-	1	-	-	-	1
4280	Cotter pin 1/16 x 1/2	-	-	-	-	-	1	-	-	-	1
310642	Front seat operating button pin	-	-	-	-	-	1	-	-	-	1
310065	Front seat operating button and rod shield (Used on 1003-13-14-16)	-	1	1	-	1	-	-	-	-	-
226527	Front seat (left) operating button spring (L.H. drive)	-	-	-	-	-	-	1	1	1	-
226544	Front seat (right) operating button spring	-	-	-	-	-	-	1	1	1	-
224302	Front seat (left) operating cable guide assy.	-	-	-	-	-	-	1	1	1	-
199718	Front seat operating spring	-	1	1	-	1	1	-	-	-	1
122611	Front seat package compartment lid hinge	-	-	-	-	-	-	3	-	-	-
220878	Front seat package compartment lid lock knob (cylinder locking type)	-	-	-	-	-	-	1	-	-	-
226361	Washer 3/4 plain special	-	-	-	-	-	-	1	-	-	-
220879	Nut 3/4-28 thread special	-	-	-	-	-	-	1	-	-	-
226722	Front seat package compartment lid lock striker plate	-	-	-	-	-	-	1	-	-	-
212848	Front seat (left) support operating mechanism--right (L.H. drive)	-	-	-	-	-	-	1	1	1	-
235339	Front seat support operating mechanism--left (L.H. drive)	-	1	1	-	1	-	-	-	-	1
314469	Front seat (left) support operating mechanism--left (L.H. drive)	-	-	-	-	-	1	-	-	-	-
235337	Front seat support operating mechanism--left (R.H. drive)	-	1	1	-	1	1	-	-	-	1
235338	Front seat support operating mechanism--right (R.H. drive)	-	1	1	-	1	-	-	-	-	1
314468	Front seat support operating mechanism--right (R.H. drive)	-	-	-	-	-	1	-	-	-	-
212850	Front seat support operating mechanism--right (R.H. drive)	-	-	-	-	-	-	1	1	-	-
212848	Front seat support operating mechanism--left (R.H. drive)	-	-	-	-	-	-	1	1	-	-
235336	Front seat support operating mechanism--right (L.H. drive)	-	1	1	-	1	1	-	-	-	1
212849	Front seat (left) support operating mechanism--left (L.H. drive)	-	-	-	-	-	-	1	1	1	-
5483	Screw 5/16-24 x 3/4 hex. hd.	-	2	2	-	2	2	-	-	-	-
7864	Screw 5/16-24 x 2-1/4 hex. hd.	-	-	-	-	-	-	1	1	-	-
7816	Screw 5/16-24 x 2-1/2 hex. hd.	-	-	-	-	-	-	1	1	-	-
5909	Screw 5/16-24 x 1-1/2 hex. hd.	-	-	-	-	-	2	-	-	-	-
5906	Screw 5/16-24 x 2-1/8 hex. hd.	-	2	2	-	2	-	-	-	-	-
5907	Screw 5/16-24 x 1-3/4 hex. hd.	-	-	-	-	-	-	1	1	-	-
5566	Screw 5/16-24 x 1-1/8 hex. hd.	-	-	-	-	-	-	1	1	-	-
3909	Plain washer 5/16 special	-	-	-	-	-	-	2	2	-	-
7005	Nut 5/16-24 standard	-	-	-	-	-	-	2	2	-	-
5504	Lockwasher 5/16	-	4	4	-	4	2	4	4	-	-
235340	Front seat support operating mechanism connecting shaft	-	1	1	-	1	-	-	-	-	-

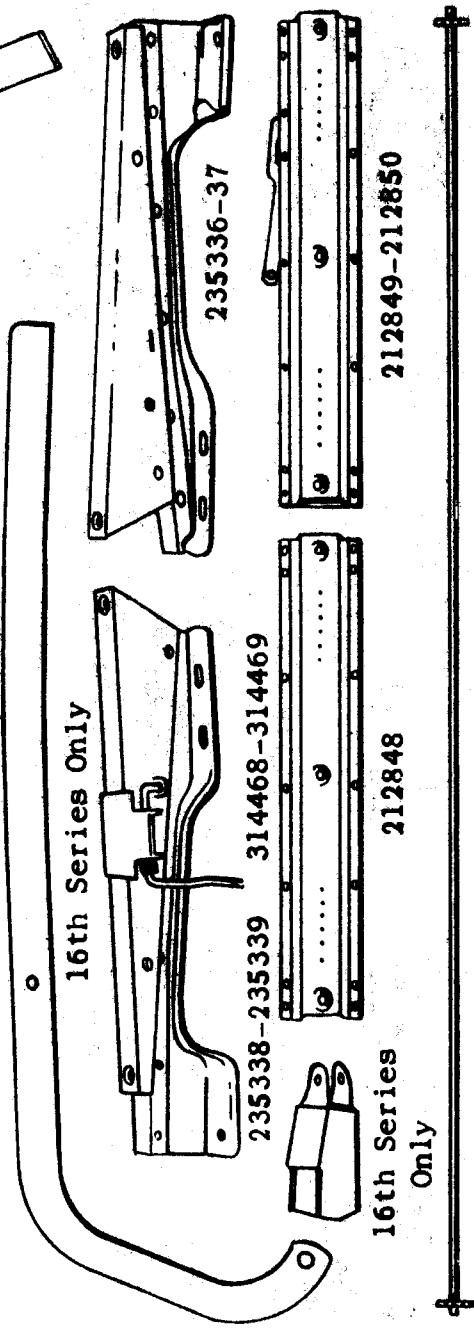
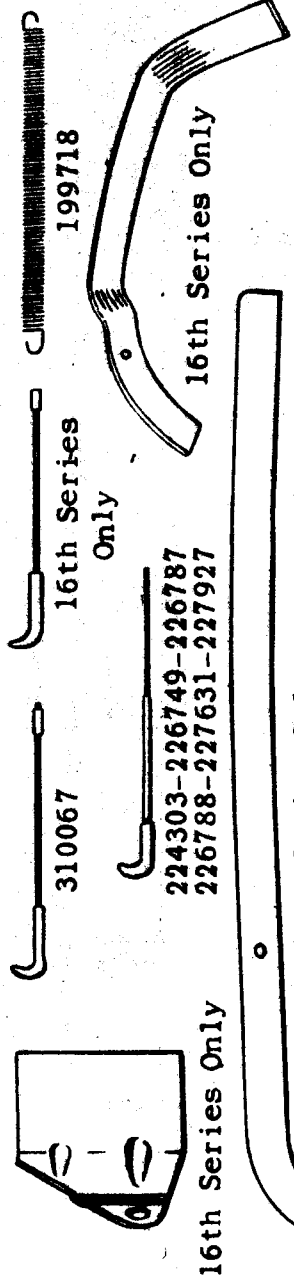
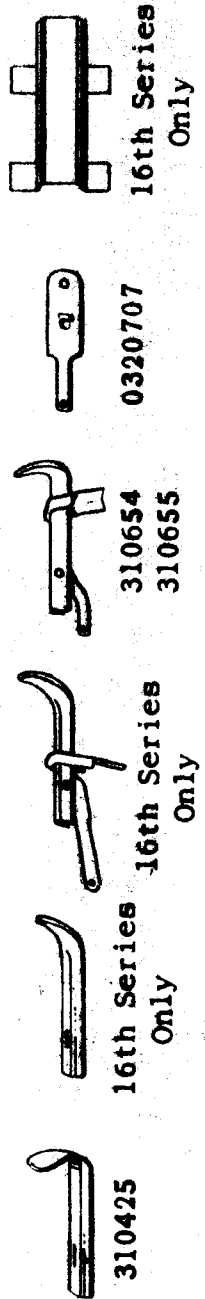

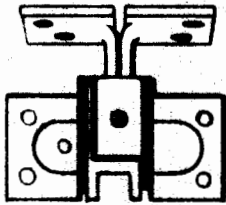

224713

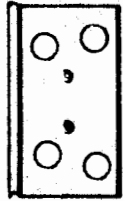

224704

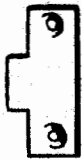

143615



308482



308425



16th Series
Only
310404



16th Series
Only
226527
226544



226527
226544

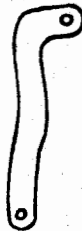

16th Series
Only
310639

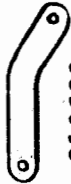

310639



16th Series
Only
310426-27



310426-27



16th Series
Only
310405



310405



226722



310065



224302



220797
226333



227899

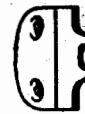

310066



227900

Piece No.	Name	(15th Series)									
		1012-32 S P. Formal Sedan	1003-13-23-33 S P. Tour. Sedan	1014-34 7 P. Tour. Sedan	1015-35 7 P. Tour. Sedan Lim.	1016-36 S P. Club Sedan	1017-37 S P. Coupe	1018-38 2-4 P. Coupe	1019-39 2-4 P. Coach Coupe	1063-73 S P. Coach Sedan	1007-27 S P. Victoria
		No. Required									
235341	Front seat support operating mechanism connecting shaft	-	-	-	-	-	1	-	-	-	1
0320707	Front seat support operating mechanism side lock	-	1	1	-	1	1	-	-	-	-

GOLF COMPARTMENT

0235501	Golf compartment door (trimmed) assembly—left (Specify set number)	-	-	-	-	-	-	1	-	-	-
0235502	Golf compartment door (trimmed) assembly—left (Specify set number)	-	-	-	-	-	-	-	1	-	-
0235503	Golf compartment door (trimmed) assembly—right (Specify set number)	-	-	-	-	-	-	1	-	-	-
0235504	Golf compartment door (trimmed) assembly—right (Specify set number)	-	-	-	-	-	-	-	1	-	-
224713	Golf compartment door hinge assembly	-	-	-	-	-	-	4	4	-	-
224704	Golf compartment door hinge seal	-	-	-	-	-	-	4	4	-	-
308425	Golf compartment door lock	-	-	-	-	-	-	2	2	-	-
308482	Golf compartment door lock cylinder lock ...	-	-	-	-	-	-	2	2	-	-
143615	Golf compartment door lock striker	-	-	-	-	-	-	2	2	-	-
224728	Golf compartment door panel—right	-	-	-	-	-	-	1	-	-	-
224729	Golf compartment door panel—left	-	-	-	-	-	-	1	-	-	-
228196	Golf compartment door panel—right	-	-	-	-	-	-	-	1	-	-
228197	Golf compartment door panel—left	-	-	-	-	-	-	-	1	-	-
228145	Golf compartment door weatherstrip	-	-	-	-	-	-	-	2	-	-
224705	Golf compartment door weatherstrip	-	-	-	-	-	-	2	-	-	-
224712	Golf compartment door weatherstrip retainer.	-	-	-	-	-	-	2	-	-	-
228147	Golf compartment door weatherstrip retainer.	-	-	-	-	-	-	-	2	-	-

HASSOCK

135807	Hassock assembly (Specify set number) (Woolen carpet) (Used on 1012-1016)	2	-	-	-	2	-	-	-	-	-
233571	Hassock assembly (Specify set number) (Mohair) (Used on 1012-1016)	2	-	-	-	2	-	-	-	-	-
174216	Hassock assembly (Specify set number) (Used on 1032-1036)	2	-	-	-	2	-	-	-	-	-

PARTITION

211539	Partition-back compartment lid handle	1	-	-	-	-	-	-	-	-	-
122611	Partition-back compartment lid hinge	2	-	-	-	-	-	-	-	-	-
105029	Partition-back compartment lid spring dowel.	1	-	-	-	-	-	-	-	-	-
229284	Partition-back compartment lid striker plate	1	-	-	-	-	-	-	-	-	-
224195	Partition-folding seat compartment panel assembly	-	-	-	1	-	-	-	-	-	-
226026	Partition-folding seat compartment panel assembly	1	-	-	-	-	-	-	-	-	-
8202	Screw 1/4-28 x 7/8 flat hd.	4	-	-	4	-	-	-	-	-	-
229499	Partition-header clock (Used on 1035) (Waltham)	-	-	-	1	-	-	-	-	-	-
235514	Partition-header clock (Used on 1035) (Jaeger)	-	-	-	1	-	-	-	-	-	-



16th Series Only

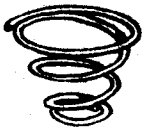

133264



211035



199571

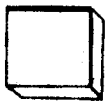

131316



229261



226025



16th Series Only



224180

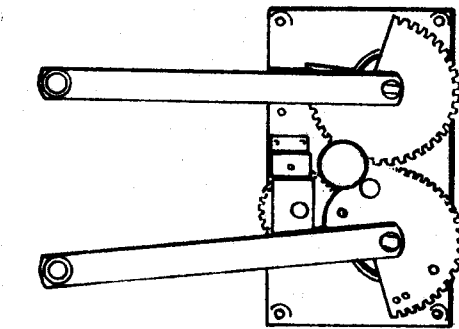

224432

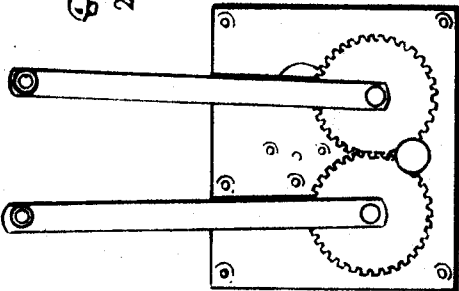

227453

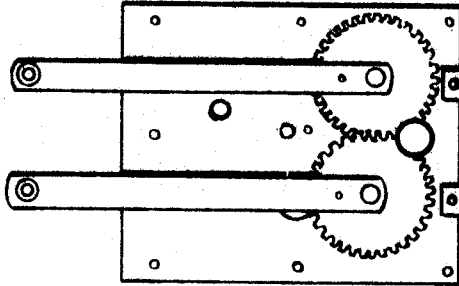

224957



211021



16th Series Only



16th Series Only



211539

226338



227500



236668-236669

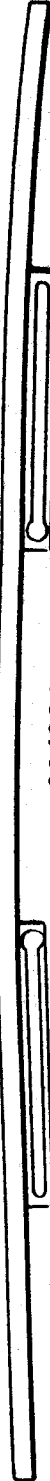

224824

Piece No.	(15th Series) Name	No. Required									
		1012-32 5 P. Formal Sedan	1003-13-23-33 5 P. Tour. Sedan	1014-34 7 P. Tour. Sedan	1015-35 7 P. Tour. Sedan Lim.	1016-36 5 P. Club Sedan	1017-37 5 P. Coupe	1018-38 2-4 P. Coupe	1019-39 2-4 P. Conv. Coupe	1063-73 5 P. Conv. Sedan	1007-27 9 P. Victoria
REAR QUARTER WINDOW											
224456	Rear quarter window curtain assembly--right (Used on 1003-13) (Furnish sample and set number)	-	1	-	-	-	-	-	-	-	-
224458	Rear quarter window curtain assembly--right (Used on 1023-33) (Furnish sample and set number)	-	1	-	-	-	-	-	-	-	-
224457	Rear quarter window curtain assembly--left (Used on 1003-13) (Furnish sample and set number)	-	1	-	-	-	-	-	-	-	-
224459	Rear quarter window curtain assembly--left (Used on 1023-33) (Furnish sample and set number)	-	1	-	-	-	-	-	-	-	-
224460	Rear quarter window curtain assembly--right (Used on 1014-15) (Furnish sample and set number)	-	-	1	1	-	-	-	-	-	-
224462	Rear quarter window curtain assembly--right (Used on 1034-35) (Furnish sample and set number)	-	-	1	1	-	-	-	-	-	-
224461	Rear quarter window curtain assembly--left (Used on 1014-15) (Furnish sample and set number)	-	-	1	1	-	-	-	-	-	-
224463	Rear quarter window curtain assembly--left (Used on 1034-35) (Furnish sample and set number)	-	-	1	1	-	-	-	-	-	-
226572	Rear quarter window curtain assembly--right (Used on 1017) (Furnish sample and set number)	-	-	-	-	-	1	-	-	-	-
226574	Rear quarter window curtain assembly--right (Used on 1037) (Furnish sample and set number)	-	-	-	-	-	1	-	-	-	-
226573	Rear quarter window curtain assembly--left (Used on 1017) (Furnish sample and set number)	-	-	-	-	-	1	-	-	-	-
226575	Rear quarter window curtain assembly--left (Used on 1037) (Furnish sample and set number)	-	-	-	-	-	1	-	-	-	-
224343	Rear quarter window curtain rod assembly ...	-	2	-	-	-	-	-	-	-	-
224237	Rear quarter window curtain rod assembly ...	-	-	2	2	-	-	-	-	-	-
226526	Rear quarter window curtain rod assembly ...	-	-	-	-	-	2	-	-	-	-
36111	Rear quarter window curtain rod anti-rattler	-	4	4	4	-	4	-	-	-	-
214901	Rear quarter window curtain rod screw eye ..	-	4	4	4	-	4	-	-	-	-
224392	Rear quarter window curtain roller--right ..	-	1	-	-	-	-	-	-	-	-
224411	Rear quarter window curtain roller--left ...	-	1	-	-	-	-	-	-	-	-
224230	Rear quarter window curtain roller--right ..	-	-	1	1	-	-	-	-	-	-
224342	Rear quarter window curtain roller--left ...	-	-	1	1	-	-	-	-	-	-
226517	Rear quarter window curtain roller--right ..	-	-	-	-	-	1	-	-	-	-
226516	Rear quarter window curtain roller--left ...	-	-	-	-	-	1	-	-	-	-
224115	Rear quarter window curtain roller bracket (female) right	-	1	1	1	-	1	-	-	-	-
224309	Rear quarter window curtain roller bracket (female) left	-	1	1	1	-	1	-	-	-	-
224137	Rear quarter window curtain roller bracket (male) assembly--right	-	1	1	1	-	-	-	-	-	-

Piece No.	Name	(15th Series)										No. Required
		1012-32 5 P. Formal Sedan	1003-13-23-33 5 P. Tour. Sedan	1014-34 7 P. Tour. Sedan	1015-35 7 P. Tour. Sedan Lim	1016-36 5 P. Club Sedan	1017-37 5 P. Coupe	1018-38 2-4 P. Coupe	1019-39 2-4 P. Conv. Coupe	1063-73 5 P. Conv. Sedan	1007-27 5 P. Victoria	
224310	Rear quarter window curtain roller bracket (male) assembly--left	-	1	1	1	-	-	-	-	-	-	-
170966	Rear quarter window curtain tassel	-	2	2	2	-	2	-	-	-	-	-
226381	Rear quarter window drain gutter	-	-	-	-	-	2	-	-	-	-	-
229274	Rear quarter window drain pan assembly--rt.	-	1	1	1	-	-	-	-	-	-	-
229273	Rear quarter window drain pan assembly--lt.	-	1	1	1	-	-	-	-	-	-	-
308806	Rear quarter window drain pan tube hose	-	2	2	2	-	-	-	-	-	-	-
220680	Rear quarter window finishing moulding assembly--right (Used on 1003-13)	-	1	-	-	-	-	-	-	-	-	-
220679	Rear quarter window finishing moulding assembly--left (Used on 1003-13)	-	1	-	-	-	-	-	-	-	-	-
220674	Rear quarter window finishing moulding assembly--right (Used on 1014-15)	-	-	1	1	-	-	-	-	-	-	-
220675	Rear quarter window finishing moulding assembly--left (Used on 1014-15)	-	-	1	1	-	-	-	-	-	-	-
224695	Rear quarter window finishing moulding assembly--right (Used on 1017)	-	-	-	-	-	1	-	-	-	-	-
224696	Rear quarter window finishing moulding assembly--left (Used on 1017)	-	-	-	-	-	1	-	-	-	-	-
231760	Rear quarter window finishing moulding--right (Used on 1023-1033)	-	1	-	-	-	-	-	-	-	-	-
231761	Rear quarter window finishing moulding--left (Used on 1023-1033)	-	1	-	-	-	-	-	-	-	-	-
231620	Rear quarter window finishing moulding--right (Used on 1034-35)	-	-	1	1	-	-	-	-	-	-	-
231621	Rear quarter window finishing moulding--left (Used on 1034-35)	-	-	1	1	-	-	-	-	-	-	-
231768	Rear quarter window finishing moulding--right (Used on 1037)	-	-	-	-	-	1	-	-	-	-	-
231769	Rear quarter window finishing moulding--left (Used on 1037)	-	-	-	-	-	1	-	-	-	-	-
218522	Rear quarter window finishing moulding wood screw ferrule No. 6	-	8	8	8	-	8	-	-	-	-	-
226054	Rear quarter window glass	-	-	-	-	-	2	-	-	-	-	-
224852	Rear quarter window lifter assembly--right	-	-	-	-	-	1	-	-	-	-	-
224853	Rear quarter window lifter assembly--left	-	-	-	-	-	1	-	-	-	-	-
226050	Rear quarter window lifter bumper	-	-	-	-	-	2	-	-	-	-	-
224806	Rear quarter window regulator assembly--rt.	-	-	-	-	-	1	-	-	-	-	-
224805	Rear quarter window regulator assembly--lt.	-	-	-	-	-	1	-	-	-	-	-
8214	Screw 1/4-28 x 3/4 flat hd.	-	-	-	-	-	4	-	-	-	-	-
8202	Screw 1/4-28 x 7/8 flat hd.	-	-	-	-	-	2	-	-	-	-	-
211021	Rear quarter window regulator handle	-	-	-	-	-	2	-	-	-	-	-
211035	Rear quarter window regulator handle escutcheon plate	-	-	-	-	-	2	-	-	-	-	-
133339	Rear quarter window regulator handle insert.	-	-	-	-	-	2	-	-	-	-	-
132972	Rear quarter window regulator handle pin	-	-	-	-	-	2	-	-	-	-	-
220695	Rear quarter window runway lower	-	-	-	-	-	4	-	-	-	-	-
226056	Rear quarter window runway upper	-	-	-	-	-	2	-	-	-	-	-
163168	Rear quarter window runway retainer	-	-	-	-	-	6	-	-	-	-	-
136008	Rear quarter window runway shim 1/32 x 1/2 x 40"	-	-	-	-	-	X	-	-	-	-	-
132429	Rear quarter window runway shim 1/16 x 1/2 x 40"	-	-	-	-	-	X	-	-	-	-	-
220660	Rear quarter window wing assembly--right	-	1	-	-	-	-	-	-	-	-	-
220661	Rear quarter window wing assembly--left	-	1	-	-	-	-	-	-	-	-	-
220662	Rear quarter window wing assembly--right	-	-	1	1	-	-	-	-	-	-	-

Piece No.	Name (15th Series)											No. Required
		1012-32 5 P. Formal Sedan	1003-13-23-33 5 P. Tour. Sedan	1014-34 7 P. Tour. Sedan	1015-35 7 P. Tour. Sedan Lim.	1016-36 5 P. Club Sedan	1017-37 5 P. Coupe	1018-38 2-4 P. Coupe	1019-39 2-4 P. Conv. Coupe	1063-73 5 P. Conv. Sedan	1007-27 5 P. Victoria	
220663	Rear quarter window wing assembly--left	-	-	1	1	-	-	-	-	-	-	-
220565	Rear quarter window wing glass	-	2	-	-	-	-	-	-	-	-	-
220574	Rear quarter window wing glass	-	-	2	2	-	-	-	-	-	-	-
220579	Rear quarter window wing glass and glass retainer assembly	-	2	-	-	-	-	-	-	-	-	-
220571	Rear quarter window wing glass and glass retainer assembly	-	-	2	2	-	-	-	-	-	-	-
228272	Rear quarter window wing glass cushion-- 1/16" thick	-	x	x	x	-	-	-	-	-	-	-
229324	Rear quarter window wing glass cushion .080 x 1-1/2 everseal	-	x	x	x	-	-	-	-	-	-	-
211649	Rear quarter window wing glass cushion 3/32 x 1-1/2 everseal	-	x	x	x	-	-	-	-	-	-	-
220562	Rear quarter window wing glass retainer assembly--front	-	2	-	-	-	-	-	-	-	-	-
220573	Rear quarter window wing glass retainer assembly--front	-	-	2	2	-	-	-	-	-	-	-
220560	Rear quarter window wing glass retainer assembly--rear	-	2	-	-	-	-	-	-	-	-	-
220572	Rear quarter window wing glass retainer assembly--rear	-	-	2	2	-	-	-	-	-	-	-
212366	Rear quarter window wing glass retainer assembly--rear screw No. 4 x 3/16 (Parker Kalon)	-	4	4	4	-	-	-	-	-	-	-
220600	Rear quarter window wing glass retainer pivot lower spacer	-	x	x	x	-	-	-	-	-	-	-
212490	Rear quarter window wing glass retainer pivot upper spring	-	2	2	2	-	-	-	-	-	-	-
220580	Rear quarter window wing glass retainer pivot upper spring plate	-	2	-	-	-	-	-	-	-	-	-
220576	Rear quarter window wing glass retainer pivot upper spring plate	-	-	2	2	-	-	-	-	-	-	-
140174	Rear quarter window wing glass retainer pivot upper spring plate screw No. 10-24 x 5/16 flat hd.	-	4	4	4	-	-	-	-	-	-	-
220643	Rear quarter window wing regulator assembly--right	-	1	1	1	-	-	-	-	-	-	-
220644	Rear quarter window wing regulator assembly--left	-	1	1	1	-	-	-	-	-	-	-
7837	Screw 1/4-20 x 7/8 hex. hd.	-	4	4	4	-	-	-	-	-	-	-
5502	Lockwasher 1/4	-	4	4	4	-	-	-	-	-	-	-
224545	Rear quarter window wing regulator handle ..	-	2	2	2	-	-	-	-	-	-	-
224119	Rear quarter window wing regulator handle escutcheon plate (Used on 1003-13-14-15) .	-	2	2	2	-	-	-	-	-	-	-
224544	Rear quarter window wing regulator handle escutcheon plate (Used on 1023-33-34-35) .	-	2	2	2	-	-	-	-	-	-	-
133264	Rear quarter window wing regulator handle escutcheon plate spring (Used on 1003-13- 14-15)	-	2	2	2	-	-	-	-	-	-	-
180671	Rear quarter window wing regulator handle insert	-	2	2	2	-	-	-	-	-	-	-
147910	Rear quarter window wing regulator handle screw	-	2	2	2	-	-	-	-	-	-	-
229282	Rear quarter window wing regulator shaft washer	-	2	2	2	-	-	-	-	-	-	-

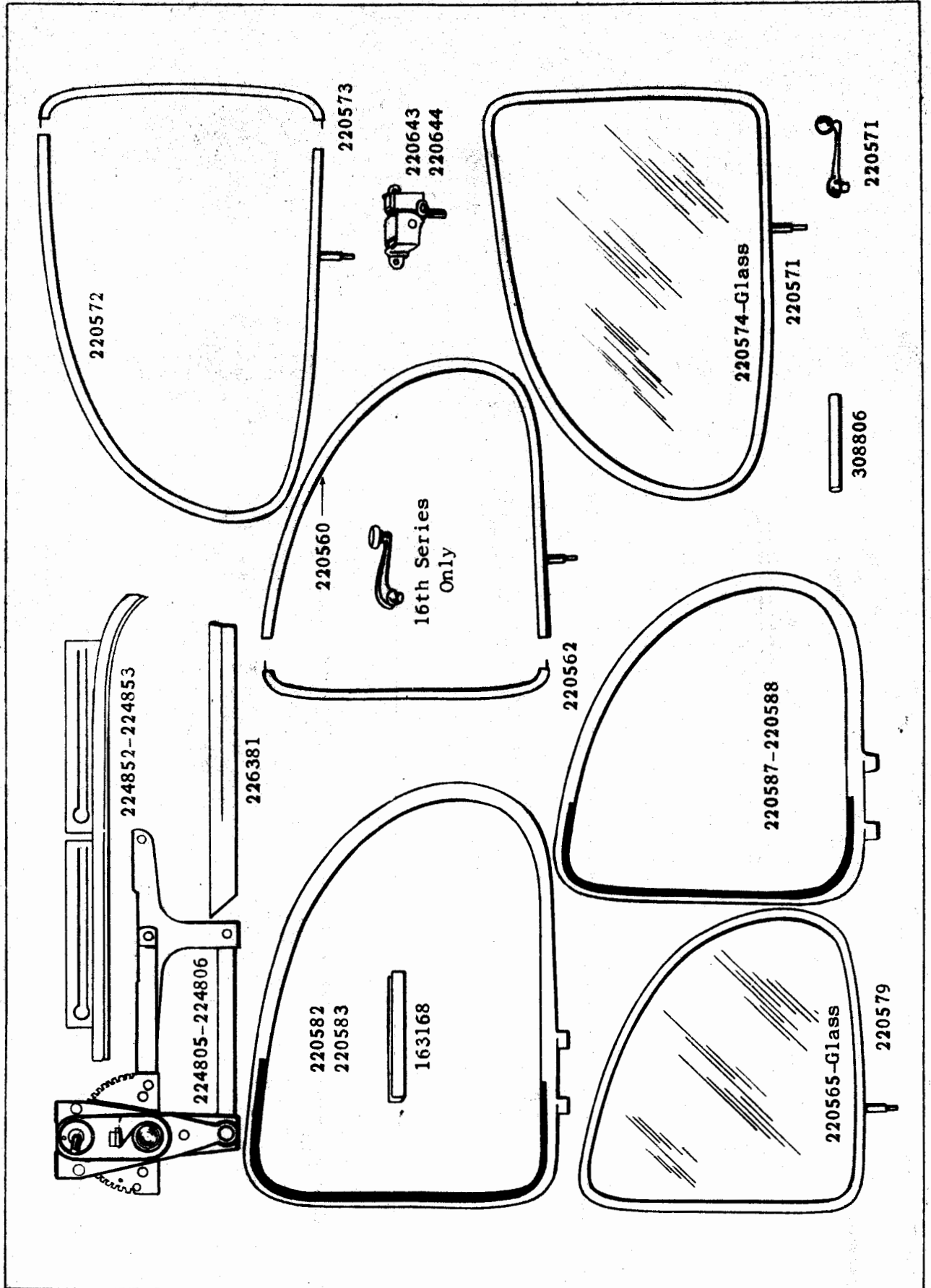

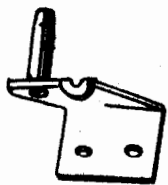

224137
224310



224309
224115

ANY

212490



229282



220576
220580



133264



170966



224545



16th Series
Only



224544



211035



224119

16th Series Only

Piece No.	Name	(15th Series)									
		1012-32 5 P. Formal Sedan	1003-13-23-33 5 P. Tour. Sedan	1014-34 7 P. Tour. Sedan	1015-35 7 P. Tour. Sedan Lim.	1016-36 5 P. Club Sedan	1017-37 5 P. Coupe	1018-38 2-4 P. Coupe	1019-39 2-4 P. Conv. Coupe	1063-73 5 P. Conv. Sedan	1007-27 5 P. Victoria
		No. Required									
220588	Rear quarter window wing weatherstrip assembly--right	-	1	-	-	-	-	-	-	-	-
220587	Rear quarter window wing weatherstrip assembly--left	-	1	-	-	-	-	-	-	-	-
220582	Rear quarter window wing weatherstrip assembly--right	-	-	1	1	-	-	-	-	-	-
220583	Rear quarter window wing weatherstrip assembly--left	-	-	1	1	-	-	-	-	-	-
220585	Rear quarter window wing weatherstrip retainer--left	-	1	-	-	-	-	-	-	-	-
220586	Rear quarter window wing weatherstrip retainer--right	-	1	-	-	-	-	-	-	-	-
220558	Rear quarter window wing weatherstrip retainer--right	-	-	1	1	-	-	-	-	-	-
220559	Rear quarter window wing weatherstrip retainer--left	-	-	1	1	-	-	-	-	-	-

REAR SEAT

231600	Rear seat back spring--right	1	1	1	1	-	-	-	-	-	-
236744	Rear seat back spring--right	-	-	-	-	-	-	-	-	-	1
224489	Rear seat back spring--right	-	-	-	-	-	1	-	-	-	-
224789	Rear seat back spring--right	-	-	-	-	-	-	1	-	-	-
236788	Rear seat back spring--right	-	-	-	-	-	-	-	-	1	-
231601	Rear seat back spring--left	1	1	1	1	-	-	-	-	-	-
236745	Rear seat back spring--left	-	-	-	-	-	-	-	-	-	1
224490	Rear seat back spring--left	-	-	-	-	-	1	-	-	-	-
224790	Rear seat back spring--left	-	-	-	-	-	-	1	-	-	-
236789	Rear seat back spring--left	-	-	-	-	-	-	-	-	1	-
233314	Rear seat cushion (trimmed) assembly (Used on 1012-1003-1013-14-1015)	1	1	1	1	-	-	-	-	-	-
233315	Rear seat cushion (trimmed) assembly (Used on 1016)	-	-	-	-	-	1	-	-	-	-
233316	Rear seat cushion (trimmed) assembly (Used on 1017)	-	-	-	-	-	-	1	-	-	-
233039	Rear seat cushion (trimmed) assembly (Used on 1032-1023-33-34-35)	1	1	1	1	-	-	-	-	-	-
233040	Rear seat cushion (trimmed) assembly (Used on 1036)	-	-	-	-	-	1	-	-	-	-
233041	Rear seat cushion (trimmed) assembly (Used on 1037)	-	-	-	-	-	-	1	-	-	-
220814	Rear seat cushion spring	1	1	1	1	-	-	-	-	-	-
236748	Rear seat cushion spring	-	-	-	-	-	1	-	-	-	-
224488	Rear seat cushion spring	-	-	-	-	-	-	1	-	-	-
224794	Rear seat cushion spring	-	-	-	-	-	-	-	1	-	-
236783	Rear seat cushion spring	-	-	-	-	-	-	-	-	-	1
212602	Rear seat folding arm rest cushion	1	1	1	1	1	1	-	-	1	1
224918	Rear seat folding arm rest cushion spacer	-	-	-	-	-	-	1	-	-	-
224082	Rear seat folding arm rest pivot screw	4	4	4	4	4	4	-	-	-	-
311143	Rear seat folding arm rest pivot screw	4	4	4	4	4	4	-	-	4	4
62065	Washer 1/4	4	4	4	4	4	4	-	-	4	4
311144	Spacer	4	4	4	4	4	4	-	-	4	4
5502	Lockwasher 1/4	8	8	8	8	8	8	-	-	4	4
211648	Nut 1/4-28	8	8	8	8	8	8	-	-	4	4
211809	Spring washer	8	8	8	8	8	8	-	-	4	4

Piece No.	Name	(15th Series)									
		1012-32 5 P. Formal Sedan	1003-13-23-33 5 P. Tour. Sedan	1014-34 7 P. Tour. Sedan	1015-35 7 P. Tour. Sedan Lim.	1016-36 5 P. Club Sedan	1017-37 5 P. Coupe	1018-38 2-4 P. Coupe	1019-39 2-4 P. Conv. Coupe	1043-73 5 P. Conv. Sedan	1007-27 5 P. Victoria
		No. Required									
231683	Rear seat folding arm rest spring	1	1	1	1	1	-	-	-	-	-
236782	Rear seat folding arm rest spring	-	-	-	-	-	-	-	-	1	-
231955	Rear seat folding arm rest spring	-	-	-	-	-	1	-	-	-	-
236747	Rear seat folding arm rest spring	-	-	-	-	-	-	-	-	-	1

REAR VIEW MIRROR

224246	Rear view mirror (complete)	1	1	1	1	1	1	1	1	1	1
224332	Rear view mirror assembly screw No. 8-32 x 5/16 rnd. hd. (special)	2	2	2	2	2	2	2	-	-	-
226331	Screw No. 8-32 x 1-1/4 oval hd. (Shakeproof)	2	2	2	2	2	2	2	-	-	-
226330	Screw No. 8-32 x 1/2 oval hd. (Shake- proof) (Used on 1012-1003-13-14-15- 16-17-18-19-39-1063-1007-1027-1073) .	1	1	1	1	1	1	1	3	3	3
224331	Rear view mirror bracket assembly	1	1	1	1	1	1	1	1	1	1

REAR WINDOW

224214	Rear window anti-rattler (inside)	-	-	-	-	-	-	1	-	-	-
307006	Rear window anti-rattler (inside) screw No. 4 x 3/8 flat hd. (Parker Kalon) (Used on 1018)	-	-	-	-	-	-	1	-	-	-
224214	Rear window anti-rattler (outside)	-	-	-	-	-	-	1	-	-	-
228311	Rear window curtain assembly (Used on 1003- 13-14-15-16-17-18)	-	1	1	1	1	1	1	-	-	-
228313	Rear window curtain assembly (Used on 1012) .	1	-	-	-	-	-	-	-	-	-
228314	Rear window curtain assembly (Used on 1032) .	1	-	-	-	-	-	-	-	-	-
228312	Rear window curtain assembly (Used on 1023- 33-34-35-36-37-38)	-	1	1	1	1	1	1	-	-	-
226309	Rear window curtain finger pull	1	1	1	1	1	1	1	-	-	-
220984	Rear window curtain hook	1	1	1	1	1	1	1	-	-	-
220972	Rear window curtain rod assembly	-	1	1	1	1	1	1	-	-	-
226524	Rear window curtain rod assembly	1	-	-	-	-	-	-	-	-	-
228156	Rear window curtain roller assembly	1	-	-	-	-	-	-	-	-	-
228155	Rear window curtain roller assembly	-	1	1	1	1	1	1	-	-	-
228158	Rear window curtain roller bracket (female) .	1	1	1	1	1	1	1	-	-	-
228157	Rear window curtain roller bracket (male) ..	1	1	1	1	1	1	1	-	-	-
220839	Rear window finishing moulding assembly	-	1	1	1	1	1	-	-	-	-
226237	Rear window finishing moulding assembly	-	-	-	-	-	-	1	-	-	-
226091	Rear window finishing moulding	1	-	-	-	-	-	-	-	-	-
6598	Screw No. 6 x 7/8 oval hd. (Parker Kalon)	-	4	4	4	4	4	-	-	-	-
218522	Rear window finishing moulding wood screw ferrule No. 6	4	4	4	4	4	4	4	-	-	-
220872	Rear window finishing rim	-	1	1	1	1	1	-	-	-	-
220924	Rear window glass	-	1	1	1	1	1	-	-	-	-
226057	Rear window glass	1	-	-	-	-	-	-	-	-	-
226223	Rear window glass	-	-	-	-	-	-	1	-	-	-
229808	Rear window glass cushion	-	1	1	1	1	1	-	-	-	-
226305	Rear window glass cushion	1	-	-	-	-	-	-	-	-	-
226203	Rear window glass retainer	1	-	-	-	-	-	-	-	-	-
229807	Rear window glass retainer	-	1	1	1	1	1	-	-	-	-

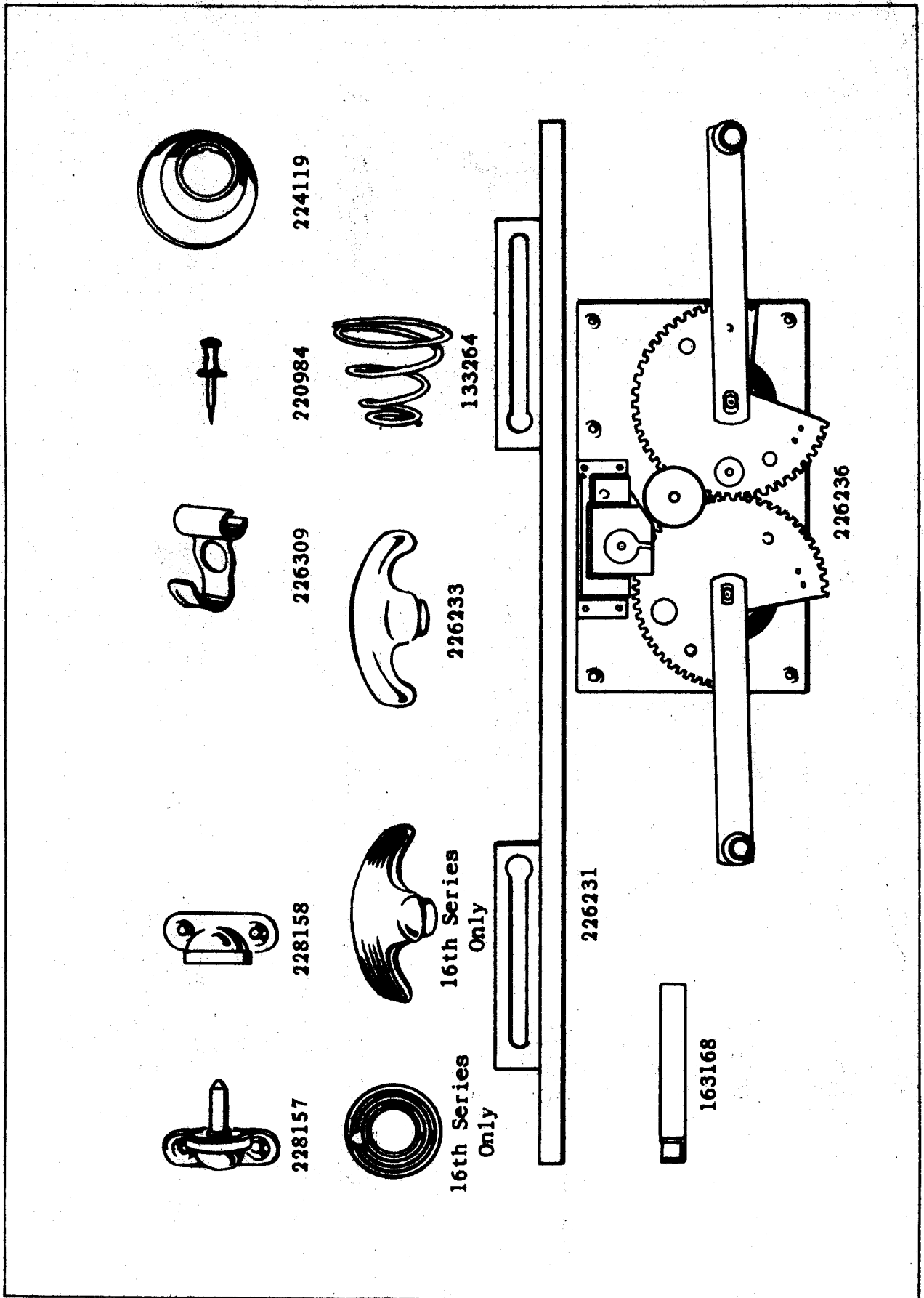



187483



224331



16th Series
Only

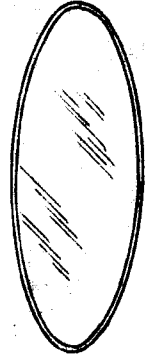

16th Series
Only



224535

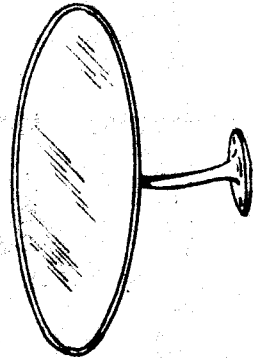

224246



16th Series
Only



224714



224279-231655



16th Series Only

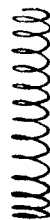

16th Series
Only



16th Series
Only



16th Series
Only

224557 - 231571 - 227807

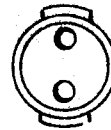

206709

Piece No.	Name	(15th Series)									
		1012-32 5 P. Formal Sedan	1003-13-23-33 5 P. Tour. Sedan	1014-34 7 P. Tour. Sedan	1018-36 7 P. Tour. Sedan Lim.	1016-36 5 P. Club Sedan	1017-37 5 P. Coupe	1018-38 2-4 P. Coupe	1019-39 2-4 P. Conv. Coupe	1063-73 5 P. Conv. Sedan	1007-27 5 P. Victoria
		No. Required									
308802	Screw No. 6 x 3/8 binding hd. (Parker Kalon)	-	13	13	13	13	13	-	-	-	-
226231	Rear window lifter assembly	-	-	-	-	-	-	1	-	-	-
226235	Rear window lifter bumper	-	-	-	-	-	-	1	-	-	-
226236	Rear window regulator assembly	-	-	-	-	-	-	1	-	-	-
226233	Rear window regulator handle	-	-	-	-	-	-	1	-	-	-
224119	Rear window regulator handle escutcheon plate	-	-	-	-	-	-	1	-	-	-
180671	Rear window regulator handle insert	-	-	-	-	-	-	1	-	-	-
147910	Rear window regulator handle screw	-	-	-	-	-	-	1	-	-	-
226274	Rear window runway lower	-	-	-	-	-	-	2	-	-	-
226273	Rear window runway upper	-	-	-	-	-	-	1	-	-	-
163168	Rear window runway retainer	-	-	-	-	-	-	2	-	-	-
136008	Rear window runway shim 1/32 x 1/2 x 40" ...	-	-	-	-	-	-	x	-	-	-
132429	Rear window runway shim 1/16 x 1/2 x 40" ...	-	-	-	-	-	-	x	-	-	-

ROBE RAIL

224557	Robe rail assembly (Specify set number) (Used on 1012-1003-13-14-15-16)	1	1	1	1	1	-	-	-	-	-
231571	Robe rail assembly (Specify set number) (Used on 1032-33-34-35-36-1023)	1	1	1	1	1	-	-	-	-	-
227807	Robe rail assembly	-	-	-	-	-	-	-	-	1	-
206709	Robe rail attaching plate	2	2	2	2	2	-	-	-	2	-
6591	Screw No. 8-32 x 1/2 flat hd. (Used on 1003-13-14-16)	-	4	4	-	4	-	-	-	-	-
228399	Screw No. 8-32 x 1-1/4 flat hd. (Shake- proof) (Used on 1023-33-34-36)	-	4	4	-	4	-	-	-	-	-
206710	Robe rail attaching plate spring	2	2	2	2	2	-	-	-	-	-

ROOF

220882	Roof joint moulding (92-1/2" long) (Used on 1003-1023)	-	2	-	-	-	-	-	-	-	-
226002	Roof joint moulding (60" long)	1	-	-	-	-	-	-	-	-	-
226006	Roof joint moulding (100-1/2" long) (Used on 1013-1033)	-	2	-	-	-	-	-	-	-	-
220883	Roof joint moulding (105-1/2" long)	-	-	2	2	-	-	-	-	-	-
226005	Roof joint moulding (91-1/2" long)	-	-	-	-	2	-	-	-	-	-
226004	Roof joint moulding (82" long)	-	-	-	-	-	2	-	-	-	-
226003	Roof joint moulding (59-1/2" long)	-	-	-	-	-	-	2	-	-	-
235344	Roof-radio antenna lead in cable assembly ..	1	1	1	1	1	1	1	-	-	-
224948	Roof rain gutter moulding right (86" long) .	1	-	-	-	-	-	-	-	-	-
235440	Roof rain gutter moulding--right (Used on 1003-1023)	-	1	-	-	-	-	-	-	-	-
235442	Roof rain gutter moulding--right (Used on 1013-1033)	-	1	-	-	-	-	-	-	-	-
235444	Roof rain gutter moulding--right	-	-	1	1	-	-	-	-	-	-
235446	Roof rain gutter moulding--right	-	-	-	-	1	-	-	-	-	-
235448	Roof rain gutter moulding--right	-	-	-	-	-	1	-	-	-	-
235450	Roof rain gutter moulding--right	-	-	-	-	-	-	1	-	-	-
228329	Roof rain gutter moulding--left (86" long) .	1	-	-	-	-	-	-	-	-	-
235441	Roof rain gutter moulding--left (Used on 1003-1023)	-	1	-	-	-	-	-	-	-	-

Piece No.	Name	(15th Series)									
		1012-32 5 P. Formal Sedan	1003-13-23-33 5 P. Tour. Sedan	1014-34 7 P. Tour. Sedan	1015-35 7 P. Tour. Sedan Lim.	1016-36 5 P. Club Sedan	1017-37 5 P. Coupe	1018-38 2-4 P. Coupe	1019-39 2-4 P. Conv. Coupe	1083-73 5 P. Conv. Sedan	1007-27 5 P. Victoria
		No. Required									
235443	Roof rain gutter moulding--left (Used on 1013-1033)	-	1	-	-	-	-	-	-	-	-
235445	Roof rain gutter moulding--left	-	-	1	1	-	-	-	-	-	-
235447	Roof rain gutter moulding--left	-	-	-	-	1	-	-	-	-	-
235449	Roof rain gutter moulding--left	-	-	-	-	-	1	-	-	-	-
235451	Roof rain gutter moulding--left	-	-	-	-	-	-	1	-	-	-
228321	Roof rear back moulding (150" long)	1	-	-	-	-	-	-	-	-	-

RUMBLE SEAT

226335	Rumble seat back spring (Luxury type)	-	-	-	-	-	-	1	1	-	-
224718	Rumble seat compartment door hinge--right ..	-	-	-	-	-	-	1	1	-	-
224719	Rumble seat compartment door hinge--left ...	-	-	-	-	-	-	1	1	-	-
5909	Screw 5/16-24 x 1-1/2 hex. hd.	-	-	-	-	-	-	4	4	-	-
5504	Lockwasher 5/16	-	-	-	-	-	-	6	6	-	-
7005	Nut 5/16-24	-	-	-	-	-	-	2	2	-	-
6305	Stud 5/16	-	-	-	-	-	-	2	2	-	-
224716	Rumble seat compartment door hinge bracket--right	-	-	-	-	-	-	1	1	-	-
224717	Rumble seat compartment door hinge bracket--left	-	-	-	-	-	-	1	1	-	-
7613	Bolt 1/4-28 x 1-3/4 carriage	-	-	-	-	-	-	4	4	-	-
7004	Nut 1/4-28	-	-	-	-	-	-	4	4	-	-
5502	Lockwasher 1/4	-	-	-	-	-	-	4	4	-	-
8222	Screw 3/8-24 x 1 flat hd.	-	-	-	-	-	-	4	4	-	-
7006	Nut 3/8-24	-	-	-	-	-	-	4	4	-	-
5506	Lockwasher 3/8	-	-	-	-	-	-	4	4	-	-
127501	Rumble seat compartment door hinge bushing ..	-	-	-	-	-	-	2	2	-	-
127498	Rumble seat compartment door hinge screw ...	-	-	-	-	-	-	2	2	-	-
3884	Washer 1/2	-	-	-	-	-	-	2	2	-	-
5510	Lockwasher 1/2	-	-	-	-	-	-	2	2	-	-
157584	Rumble seat compartment door operating bolt.	-	-	-	-	-	-	2	2	-	-
7104	Nut 1/4-28 castle	-	-	-	-	-	-	2	2	-	-
4280	Cotter pin 1/16 x 1/2	-	-	-	-	-	-	2	2	-	-
196243	Rumble seat compartment door operating spring	-	-	-	-	-	-	2	2	-	-
157585	Rumble seat compartment door operating spring washer	-	-	-	-	-	-	2	2	-	-
224715	Rumble seat compartment door panel	-	-	-	-	-	-	1	1	-	-
235348	Rumble seat compartment door weatherstrip ..	-	-	-	-	-	-	1	1	-	-
224961	Rumble seat compartment drain gutter assy. .	-	-	-	-	-	-	1	1	-	-
233528	Rumble seat cushion assembly	-	-	-	-	-	-	1	1	-	-
235279	Rumble seat cushion spring;	-	-	-	-	-	-	1	1	-	-
148338	Rumble seat door lock	-	-	-	-	-	-	1	1	-	-
229393	Rumble seat door lock bolt weatherstrip	-	-	-	-	-	-	1	1	-	-
228127	Rumble seat door lock operating bell crank yoke and clip assembly--front	-	-	-	-	-	-	-	1	-	-
228129	Rumble seat door lock operating bell crank yoke and clip assembly--rear	-	-	-	-	-	-	-	1	-	-
229392	Rumble seat door lock operating bell crank clip	-	-	-	-	-	-	-	4	-	-
228139	Rumble seat door lock operating knob	-	-	-	-	-	-	-	1	-	-
226960	Rumble seat door lock operating knob ferrule	-	-	-	-	-	-	-	1	-	-
226961	Rumble seat door lock operating knob ferrule clinch plate	-	-	-	-	-	-	-	1	-	-
224831	Rumble seat door lock operating lever	-	-	-	-	-	-	1	-	-	-

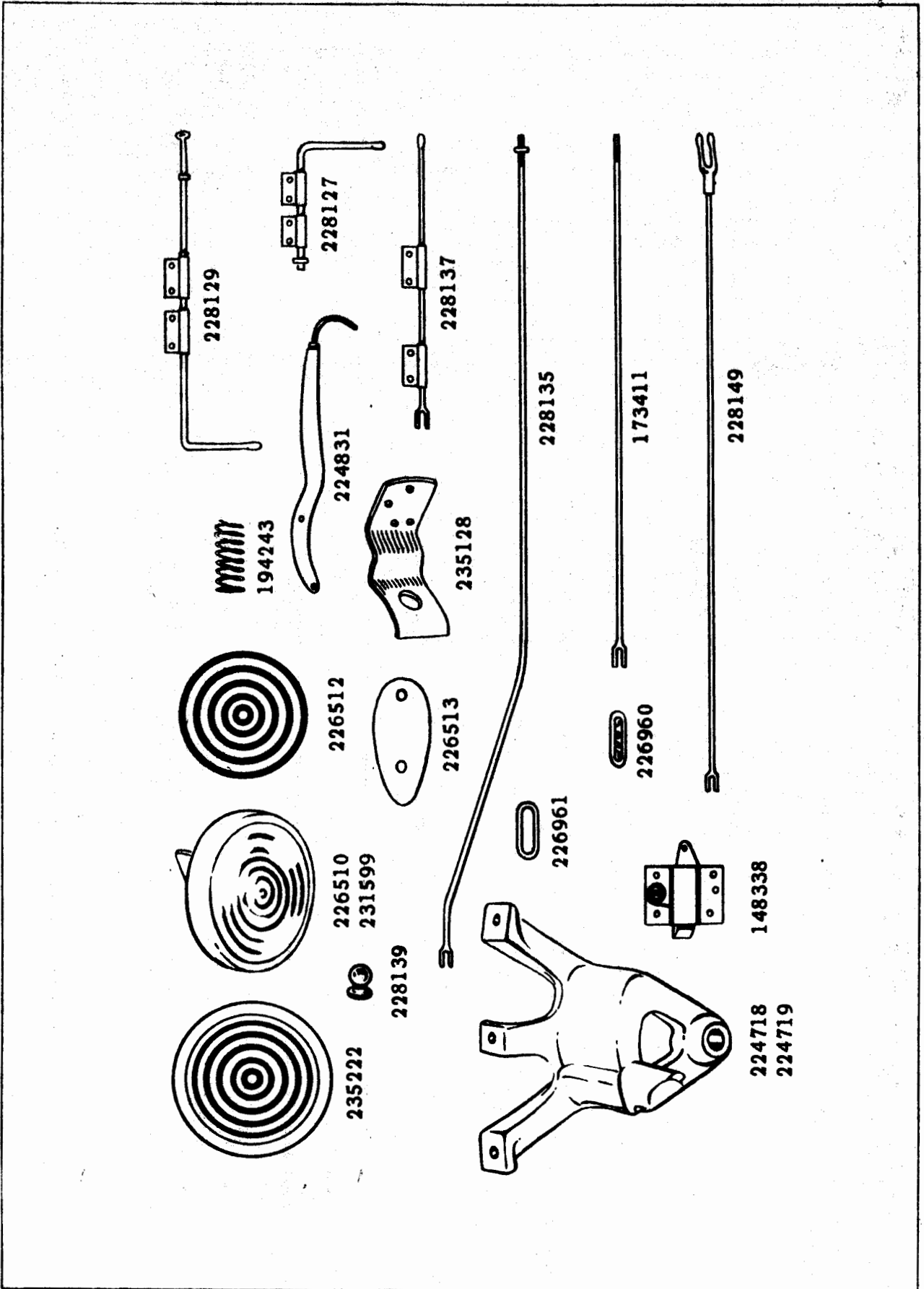

Piece No.	Name	(15th Series)									
		1012-32 5 P. Formal Sedan	1003-13-23-33 5 P. Tour. Sedan	1014-34 7 P. Tour. Sedan	1015-35 7 P. Tour. Sedan Lim.	1016-36 5 P. Club Sedan	1017-37 5 P. Coupe	1018-38 2-4 P. Coupe	1019-39 2-4 P. Conv. Coupe	1063-73 5 P. Conv. Sedan	1007-27 5 P. Victoria
		No. Required									
228137	Rumble seat door lock operating rod yoke and clip assembly--front	-	-	-	-	-	-	-	1	-	-
173411	Rumble seat door lock operating rod and yoke end assembly	-	-	-	-	-	-	1	-	-	-
228149	Rumble seat door lock operating rod and yoke end assembly--rear	-	-	-	-	-	-	-	1	-	-
228135	Rumble seat door lock operating rod and yoke end assembly--side	-	-	-	-	-	-	-	1	-	-
7513	Yoke end adj. 3/16	-	-	-	-	-	-	1	2	-	-
7003	Nut No. 10-32	-	-	-	-	-	-	1	2	-	-
7523	Yoke end pin 3/16	-	-	-	-	-	-	3	5	-	-
3906	Washer 3/16 "Y" standard	-	-	-	-	-	-	2	-	-	-
4690	Cotter pin 1/16 x 3/8	-	-	-	-	-	-	3	5	-	-
228142	Rumble seat door lock operating rod front clip	-	-	-	-	-	-	-	2	-	-
228143	Rumble seat door lock operating rod sideclip	-	-	-	-	-	-	-	1	-	-
157625	Rumble seat door lock striker	-	-	-	-	-	-	1	1	-	-
226513	Rumble seat step upper gasket	-	-	-	-	-	-	1	1	-	-
226512	Rumble seat step upper mat	-	-	-	-	-	-	1	1	-	-
226512	Rumble seat step lower mat	-	-	-	-	-	-	1	1	-	-
226510	Rumble seat step upper assembly (L.H. drive)	-	-	-	-	-	-	1	1	-	-
231599	Rumble seat step upper assembly (R.H. drive)	-	-	-	-	-	-	1	1	-	-
5666	Stud 3/8	-	-	-	-	-	-	2	2	-	-
114055	Washer	-	-	-	-	-	-	2	2	-	-
5506	Lockwasher 3/8	-	-	-	-	-	-	2	2	-	-
7006	Nut 3/8-24	-	-	-	-	-	-	2	2	-	-
235222	Rumble seat step lower assembly	-	-	-	-	-	-	1	1	-	-
7804	Screw 5/16-18 x 3/4 hex. hd.	-	-	-	-	-	-	2	2	-	-
5504	Lockwasher 5/16"	-	-	-	-	-	-	2	2	-	-
235128	Rumble seat step lower bracket	-	-	-	-	-	-	1	1	-	-
310638	Rumble seat step lower bracket nut	-	-	-	-	-	-	1	1	-	-
220881	Lockwasher 3/4 (Shakeproof)	-	-	-	-	-	-	1	1	-	-

SUN VISOR

224744	Sun visor assembly (Specify set number)	2	2	2	2	2	2	2	-	-	-
224714	Sun visor hinge bracket assembly	2	2	2	2	2	2	2	-	-	-
228352	Sun visor hinge bracket assembly screw 1/4-28 x 5/8 oval hd. (spl.) conical point	4	4	4	4	4	4	4	-	-	-

TOGGLE GRIP

224279	Toggle grip (Used on 1012-1003-13-14-15-16-17)	2	2	2	2	2	2	-	-	-	-
231655	Toggle grip (Used on 1032-1023-1033-34-35-36-37)	2	2	2	2	2	2	-	-	-	-
224536	Toggle grip pivot stud	2	2	2	2	2	2	-	-	-	-
187483	Toggle grip pivot stud screw bushing	2	2	2	2	2	2	-	-	-	-
229250	Toggle grip pivot stud spring washer	2	2	2	2	2	2	-	-	-	-
224535	Toggle grip pivot stud washer	2	2	2	2	2	2	-	-	-	-

Piece No.	Name	(15th Series)										
		1012-32 5 P. Formal Sedan	1003-13-23-33 5 P. Tour Sedan	1014-34 7 P. Tour Sedan	1015-35 7 P. Tour Sedan Lim.	1016-36 5 P. Club Sedan	1017-37 5 P. Coupe	1018-38 2-4 P. Coupe	1019-39 2-4 P. Conv. Coupe	1063-73 5 P. Conv. Sedan	1007-27 5 P. Victoria	
		No. Required										
TOP												
235243	Top assembly--less fabric	-	-	-	-	-	-	-	-	1	-	-
0230031	Top body bracket assembly	-	-	-	-	-	-	-	-	1	-	-
236661	Top bow auxiliary	-	-	-	-	-	-	-	-	-	1	-
236638	Top bow auxiliary	-	-	-	-	-	-	-	-	-	-	1
227292	Top bow auxiliary to hinge plate screw spacer	-	-	-	-	-	-	-	-	-	2	2
236304	Top center bow assembly	-	-	-	-	-	-	-	-	-	1	-
0230054	Top clevis handle assembly	-	-	-	-	-	-	-	-	2	-	-
229595	Top envelope assembly	-	-	-	-	-	-	-	-	1	-	-
0230041	Top folding pillar bow	-	-	-	-	-	-	-	-	1	-	-
228177	Top folding pillar bumper	-	-	-	-	-	-	-	-	x	-	-
228094	Top folding pillar hinge--right	-	-	-	-	-	-	-	-	1	-	-
228095	Top folding pillar hinge--left	-	-	-	-	-	-	-	-	1	-	-
8204	Screw 1/4-28 x 2 flat head	-	-	-	-	-	-	-	-	6	-	-
235244	Top folding pillar hinge bracket--right	-	-	-	-	-	-	-	-	1	-	-
235245	Top folding pillar hinge bracket--left	-	-	-	-	-	-	-	-	1	-	-
8204	Screw 1/4-28 x 2 flat head	-	-	-	-	-	-	-	-	2	-	-
228069	Top folding pillar hinge pin	-	-	-	-	-	-	-	-	2	-	-
0235563	Top front roof rail bolt	-	-	-	-	-	-	-	-	2	-	-
0230032	Top header	-	-	-	-	-	-	-	-	1	-	-
0230033	Top header bracket--right	-	-	-	-	-	-	-	-	1	-	-
0230034	Top header bracket--left	-	-	-	-	-	-	-	-	1	-	-
227756	Top hold down clamp plate	-	-	-	-	-	-	-	-	-	2	-
227754	Top hold down clamp assembly--right	-	-	-	-	-	-	-	-	-	1	-
227755	Top hold down clamp assembly--left	-	-	-	-	-	-	-	-	-	1	-
0230048	Top joint--upper	-	-	-	-	-	-	-	-	2	-	-
0230049	Top joint lower--right	-	-	-	-	-	-	-	-	1	-	-
0230050	Top joint lower--left	-	-	-	-	-	-	-	-	1	-	-
236386	Top main bow assembly	-	-	-	-	-	-	-	-	-	-	1
236624	Top main bow hinge--right	-	-	-	-	-	-	-	-	-	1	-
236625	Top main bow hinge--left	-	-	-	-	-	-	-	-	-	1	-
236174	Top main bow hinge lower--right	-	-	-	-	-	-	-	-	-	-	1
236175	Top main bow hinge lower--left	-	-	-	-	-	-	-	-	-	-	1
227660	Top main bow hinge to body bracket screw ...	-	-	-	-	-	-	-	-	-	2	2
236632	Top main bow hinge body bracket--right	-	-	-	-	-	-	-	-	-	1	-
236172	Top main bow hinge body bracket--right	-	-	-	-	-	-	-	-	-	-	1
236633	Top main bow hinge body bracket--left	-	-	-	-	-	-	-	-	-	1	-
236173	Top main bow hinge body bracket--left	-	-	-	-	-	-	-	-	-	-	1
236024	Top main bow hinge pad--right	-	-	-	-	-	-	-	-	-	1	-
236025	Top main bow hinge pad--left	-	-	-	-	-	-	-	-	-	1	-
236069	Top prop bracket (on body)	-	-	-	-	-	-	-	-	-	1	-
236710	Top prop bracket (on body)	-	-	-	-	-	-	-	-	-	-	1
236777	Top prop bracket (on body) adjusting screw 1/2 shoulder, 3/8-24 hex. hd.	-	-	-	-	-	-	-	-	-	2	2
236776	Top rear bow bracket adjusting plate (serrated)	-	-	-	-	-	-	-	-	-	2	2
236325	Top rear bow	-	-	-	-	-	-	-	-	-	1	-
236419	Top rear bow	-	-	-	-	-	-	-	-	-	-	1
0230053	Top rear bow	-	-	-	-	-	-	-	-	1	-	-
0230051	Top rear bow slat iron--right	-	-	-	-	-	-	-	-	1	-	-
0230052	Top rear bow slat iron--left	-	-	-	-	-	-	-	-	1	-	-
229593	Top rear curtain assembly	-	-	-	-	-	-	-	-	1	-	-
227579	Top rear window glass	-	-	-	-	-	-	-	-	1	-	-
313561	Top rear window glass	-	-	-	-	-	-	-	-	-	1	1
313563	Top rear window glass frame--inner	-	-	-	-	-	-	-	-	-	1	1

Piece No.	Name	(15th Series)										No. Required
		1012-32 5 P. Formal Sedan	1003-13-23-33 5 P. Tour. Sedan	1014-34 7 P. Tour. Sedan	1015-35 7 P. Tour. Sedan Lim.	1016-36 5 P. Club Sedan	1017-37 5 P. Coupe	1018-38 2-4 P. Coupe	1019-39 2-4 P. Conv. Coupe	1063-73 5 P. Conv. Sedan	1007-27 5 P. Victoria	
313562	Top rear window glass frame--outer	-	-	-	-	-	-	-	-	-	1	1
179131	Top rear window glass frame	-	-	-	-	-	-	-	-	1	-	-
236104	Top removable center pillar on body dove-tail--right	-	-	-	-	-	-	-	-	-	1	-
236105	Top removable center pillar on body dove-tail--left	-	-	-	-	-	-	-	-	-	1	-
236106	Top removable center pillar on pillar dove-tail--right	-	-	-	-	-	-	-	-	-	1	-
236107	Top removable center pillar on pillar dove-tail--left	-	-	-	-	-	-	-	-	-	1	-
236673	Top removable center pillar on pillar dove-tail--thumbcrew	-	-	-	-	-	-	-	-	-	2	-
236108	Top removable center pillar top lock plate--right	-	-	-	-	-	-	-	-	-	1	-
236109	Top removable center pillar top lock plate--left	-	-	-	-	-	-	-	-	-	1	-
236166	Top removable center pillar pad--right	-	-	-	-	-	-	-	-	-	1	-
236167	Top removable center pillar pad--left	-	-	-	-	-	-	-	-	-	1	-
0230046	Top shoulder bolt roof rail--rear	-	-	-	-	-	-	-	-	2	-	-
0235564	Top side rail--front right (wood)	-	-	-	-	-	-	-	-	1	-	-
0235565	Top side rail--front left (wood)	-	-	-	-	-	-	-	-	1	-	-
0235566	Top side rail--rear right (wood)	-	-	-	-	-	-	-	-	1	-	-
0235567	Top side rail--rear left (wood)	-	-	-	-	-	-	-	-	1	-	-
0235562	Top side rail hinge assembly	-	-	-	-	-	-	-	-	2	-	-
0235560	Top side rail slat iron--front	-	-	-	-	-	-	-	-	2	-	-
0235561	Top side rail slat iron--rear	-	-	-	-	-	-	-	-	2	-	-
227765	Top side roof rail bumper center	-	-	-	-	-	-	-	-	-	2	-
236022	Top side roof rail locking dowel plate--rt..	-	-	-	-	-	-	-	-	-	1	-
236023	Top side roof rail locking dowel plate--lt..	-	-	-	-	-	-	-	-	-	1	-
236662	Top slat iron assembly--right	-	-	-	-	-	-	-	-	-	1	-
236640	Top slat iron assembly--right	-	-	-	-	-	-	-	-	-	-	1
236663	Top slat iron assembly--left	-	-	-	-	-	-	-	-	-	1	-
236641	Top slat iron assembly--left	-	-	-	-	-	-	-	-	-	-	1
236642	Top slat iron to front cross bar bracket--right	-	-	-	-	-	-	-	-	-	-	1
236643	Top slat iron to front cross bar bracket--left	-	-	-	-	-	-	-	-	-	-	1
236676	Top slat iron to front cross bar bracket--right	-	-	-	-	-	-	-	-	-	1	-
236677	Top slat iron to front cross bar bracket--left	-	-	-	-	-	-	-	-	-	1	-
227646	Top to windshield clamp assembly	-	-	-	-	-	-	-	-	2	2	2
5587	Screw No. 10-32 x 3/8 oval hd.	-	-	-	-	-	-	-	-	4	4	4
227621	Top to windshield header bumper	-	-	-	-	-	-	-	-	3	3	3
227647	Top to windshield clamp catch	-	-	-	-	-	-	-	-	2	2	2
229262	Top to windshield header weatherstrip	-	-	-	-	-	-	-	-	1	-	-
TRUNK												
312709	Trunk--drain gutter finishing strip	x	x	x	x	x	-	-	-	-	-	-
235095	Trunk emblem (Used on 1003-12-13-14-15-16-1063)	1	1	1	1	1	-	-	-	-	1	-
235096	Trunk emblem (Used on 1023-32-33-34-35-36-1073)	1	1	1	1	1	-	-	-	-	1	-
62065	Washer 1/4	1	1	1	1	1	-	-	-	-	1	-

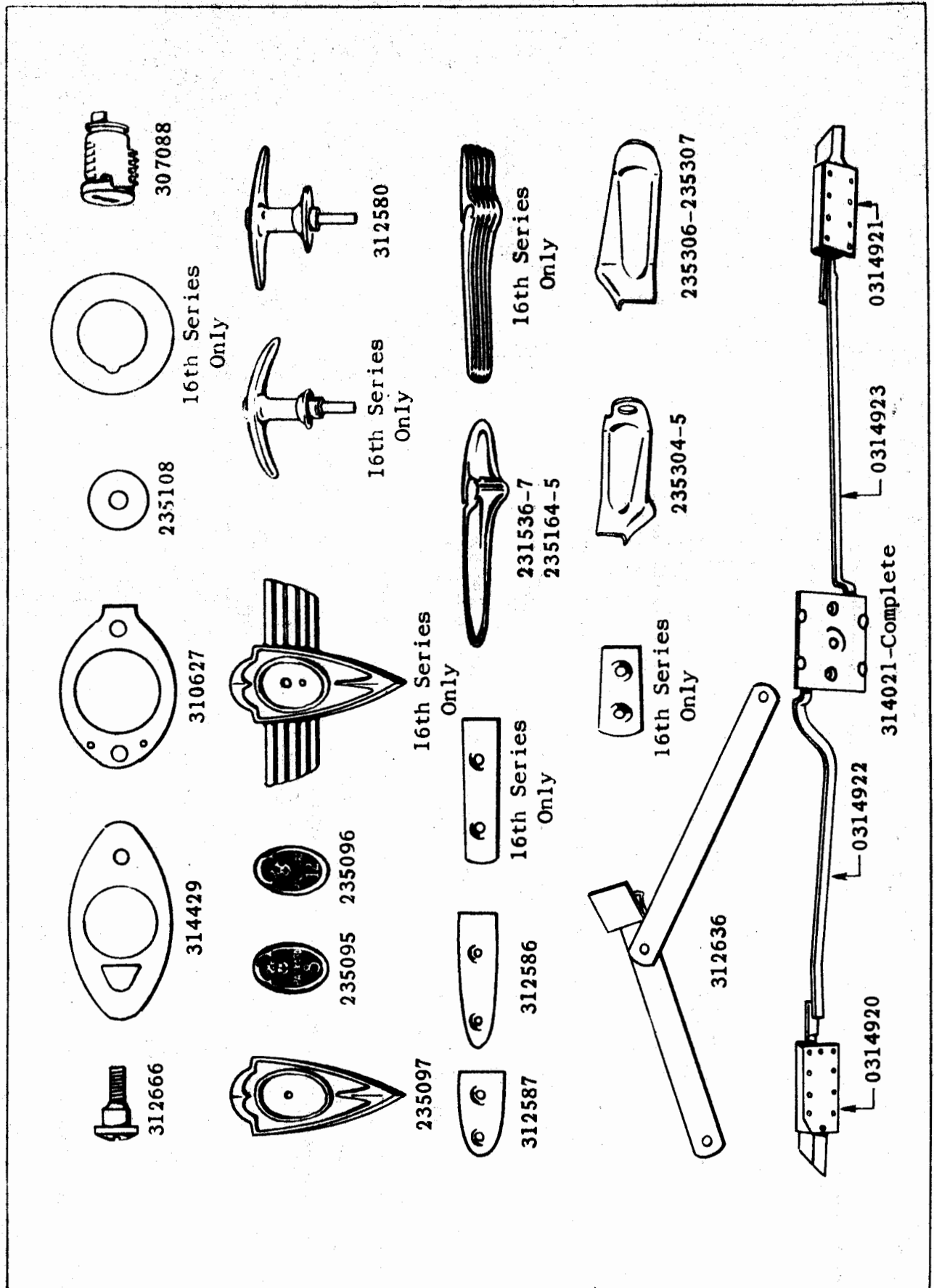

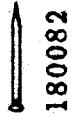

180082



184433

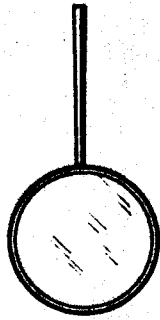

224629

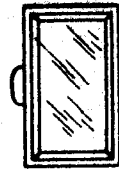

187596

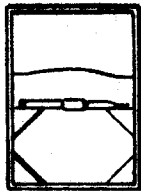

224262



224263

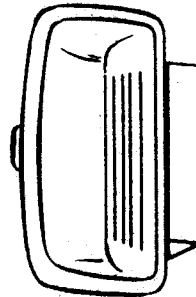

226031



224647

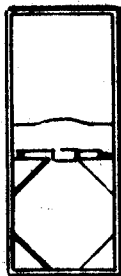

235177

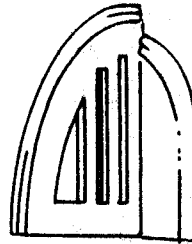

224676



235176

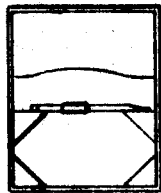

187594

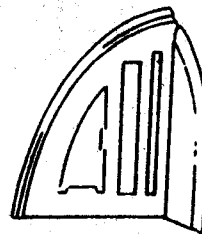

235181
224503

Piece No.	Name	(15th Series)										No. Required
		1012-32 5 P. Formal Sedan	1003-13-23-33 5 P. Tour. Sedan	1014-34 7 P. Tour. Sedan	1015-35 7 P. Tour. Sedan Lim.	1016-36 5 P. Club Sedan	1017-37 5 P. Coupe	1018-38 2-4 P. Coupe	1019-39 2-4 P. Conv. Coupe	1063-73 5 P. Conv. Sedan	1007-27 5 P. Victoria	
5502	Lockwasher	1	1	1	1	1	-	-	-	-	1	-
239618	Spacer	2	2	2	2	2	-	-	-	-	2	-
239617	Nut 1/4-20	1	1	1	1	1	-	-	-	-	1	-
235097	Trunk emblem base	1	1	1	1	1	-	-	-	-	1	-
235108	Trunk emblem base gasket	1	1	1	1	1	-	-	-	-	1	-
235456	Trunk--lid assembly (Supersedes 312704)	1	1	1	1	1	-	-	-	-	1	-
312636	Trunk--lid brace assembly	1	1	1	1	1	-	-	-	-	1	-
312666	Trunk--lid brace screw	2	2	2	2	2	-	-	-	-	2	-
312667	Trunk--lid brace screw spring washer 13/32 dia.	1	1	1	1	1	-	-	-	-	2	-
7304	Nut 1/4-20 plain	2	2	2	2	2	-	-	-	-	-	-
235165	Trunk--lid hinge assembly--left	-	-	-	-	-	1	-	-	-	-	-
235164	Trunk--lid hinge assembly--right	-	-	-	-	-	1	-	-	-	-	-
231537	Trunk--lid hinge assembly--left	1	1	1	1	-	-	-	-	-	1	-
231536	Trunk--lid hinge assembly--right	1	1	1	1	-	-	-	-	-	1	-
6650	Screw 1/4-20 x 1/2 hex. hd.	8	8	8	8	8	-	-	-	-	-	-
6751	Lockwasher 1/4 (Shakeproof)	8	8	8	8	8	-	-	-	-	-	-
312587	Trunk--lid hinge liner (body half)	2	2	2	2	2	-	-	-	-	2	-
312586	Trunk--lid hinge liner (lid half)	2	2	2	2	2	-	-	-	-	2	-
314021	Trunk--lid lock assembly	1	1	1	1	1	-	-	-	-	1	-
5676	Screw No. 10-32 x 3/8 rnd. hd.	8	8	8	8	8	-	-	-	-	-	-
5868	Screw No. 10-32 x 5/8 flat hd.	2	2	2	2	2	-	-	-	-	-	-
5491	Lockwasher No. 10 countersunk (Shakeproof)	2	2	2	2	2	-	-	-	-	-	-
5935	Lockwasher 3/16 (Shakeproof)	8	8	8	8	8	-	-	-	-	-	-
312580	Trunk--lid lock handle (with key lock)	1	1	1	1	1	-	-	-	-	1	-
314429	Trunk--lid lock handle gasket	1	1	1	1	1	-	-	-	-	1	-
5676	Trunk--lid lock handle screw No. 10-32 x 3/8 rnd. hd.	1	1	1	1	1	-	-	-	-	-	-
3867	Washer 3/16	1	1	1	1	1	-	-	-	-	-	-
6397	Lockwasher 3/16 (Shakeproof)	1	1	1	1	1	-	-	-	-	-	-
6619	Screw No. 10-32 x 9/16 oval hd.	2	2	2	2	2	-	-	-	-	-	-
307088	Trunk--lid lock handle--cylinder lock	1	1	1	1	1	-	-	-	-	1	-
310627	Trunk--lid lock handle screw--tapped plate .	1	1	1	1	1	-	-	-	-	-	-
0314920	Trunk--lid lock plunger assembly--right	1	1	1	1	1	-	-	-	-	1	-
0314921	Trunk--lid lock plunger assembly--left	1	1	1	1	1	-	-	-	-	1	-
0314922	Trunk--lid lock rack--right	1	1	1	1	1	-	-	-	-	1	-
0314923	Trunk--lid lock rack--left	1	1	1	1	1	-	-	-	-	1	-
235306	Trunk--lid lock striker--right	1	1	1	1	-	-	-	-	-	1	-
235304	Trunk--lid lock striker--right	-	-	-	-	1	-	-	-	-	-	-
235307	Trunk--lid lock striker--left	1	1	1	1	-	-	-	-	-	1	-
235305	Trunk--lid lock striker--left	-	-	-	-	1	-	-	-	-	-	-
312596	Trunk--lid weatherstrip (cemented on trunk lid)	1	1	1	1	1	-	-	-	-	-	-
235420	Trunk--lid weatherstrip (cemented in rain gutter)	1	1	1	1	1	-	-	-	-	1	-

VANITY CASE

235190	Vanity cabinet--right (Used on 1032)	1	-	-	-	-	-	-	-	-	-	-
235191	Vanity cabinet--left (Used on 1032)	1	-	-	-	-	-	-	-	-	-	-
235176	Vanity cabinet bottle (Used on 1032)	2	-	-	-	-	-	-	-	-	-	-
235177	Vanity cabinet memorandum book (Used on 1032)	2	-	-	-	-	-	-	-	-	-	-
184433	Vanity cabinet memorandum book pencil (Used on 1032)	2	-	-	-	-	-	-	-	-	-	-

Piece No.	(15th Series) Name	No. Required									
		1012-32 5 P. Formal Sedan	1003-13-23-33 5 P. Tour. Sedan	1014-34 7 P. Tour. Sedan	1015-35 7 P. Tour. Sedan Lim.	1016-36 5 P. Club Sedan	1017-37 5 P. Coupe	1018-38 2-4 P. Coupe	1019-39 2-4 P. Conv. Coupe	1063-73 5 P. Conv. Sedan	1007-27 5 P. Victoria
226031	Vanity case assembly (Used on 1016)	-	-	-	-	1	-	-	-	-	-
105029	Vanity case assembly spring dowel (Used on 1016)	-	-	-	-	1	-	-	-	-	-
224647	Vanity case ash receiver (Used on 1012-13-14-15-17-1003)	1	1	1	1	-	1	-	-	-	-
224503	Vanity case cover plate (Used on 1017)	-	-	-	-	-	1	-	-	-	-
224676	Vanity case cover plate (Used on 1014-15) ..	-	-	1	1	-	-	-	-	-	-
235181	Vanity case cover plate--right (Used on 1012-13-1003)	1	1	-	-	-	-	-	-	-	-
224262	Vanity case memorandum book (Not used on 1016-1032)	1	1	1	1	1	1	-	-	1	1
187594	Vanity case memorandum book (Used on 1016) ..	-	-	-	-	1	-	-	-	-	-
180082	Vanity case memorandum book pencil (Not used on 1032)	1	1	1	1	1	1	-	-	1	1
224263	Vanity case mirror (Used on 1012-13-14-15-17-1003-1063-73-1007-27)	1	1	1	1	-	1	-	-	1	1
187596	Vanity case mirror (Used on 1016)	-	-	-	-	1	-	-	-	-	-
224629	Vanity case mirror (Used on 1023-33-34-35-36-1037)	-	1	1	1	1	1	-	-	-	-

VENTILATOR

220711	Ventilator cover assembly	1	1	1	1	1	1	1	-	-	-
235428	Ventilator cover assembly	-	-	-	-	-	-	-	1	1	1
5569	Ventilator cover attaching screw No. 10-32 x 1/2 fill. hd.	4	4	4	4	4	4	4	4	-	-
3866	Washer 3/16	4	4	4	4	4	4	4	4	-	-
5500	Lockwasher 3/16	4	4	4	4	4	4	4	4	-	-
7003	Nut No. 10-32	4	4	4	4	4	4	4	4	-	-
220718	Ventilator cover operating lever and roller assembly	1	1	1	1	1	1	1	1	1	1
145661	Ventilator cover operating lever and roller assembly screw No. 10-32 x 5/16 hex. hd. .	1	1	1	1	1	1	1	1	-	-
5739	Screw No. 10 (.190)-32 x 1/2 hex. hd. .	1	1	1	1	1	1	1	1	-	-
5500	Lockwasher 3/16	2	2	2	2	2	2	2	2	-	-
220723	Ventilator cover operating lever ratchet assembly	1	1	1	1	1	1	1	1	1	1
5569	Screw No. 10-32 x 1/2 fill. hd.	2	2	2	2	2	2	2	2	-	-
5500	Lockwasher 3/16	2	2	2	2	2	2	2	2	-	-
7003	Nut No. 10-32	2	2	2	2	2	2	2	2	-	-
220719	Ventilator cover operating lever ratchet bracket	2	2	2	2	2	2	2	2	2	2
220735	Ventilator cover operating lever ratchet yoke end pin 5/16	1	1	1	1	1	1	1	1	1	1
4280	Cotter pin 1/16 x 1/2 spring	1	1	1	1	1	1	1	1	-	-
199374	Ventilator cover spring	1	1	1	1	1	1	1	1	1	1
220717	Ventilator drain gutter assembly	-	1	1	1	1	1	1	1	1	1
102507	Ventilator drain tube grommet	1	1	1	1	1	1	1	1	1	1
231657	Ventilator drain tube hose	2	2	2	2	2	2	2	2	2	2
5253	Clamp screw No. 10-32 x 3/4 rnd. hd. .	2	2	2	2	2	2	2	2	2	2
5500	Lockwasher No. 10	2	2	2	2	2	2	2	2	2	2
7003	Nut No. 10-32	2	2	2	2	2	2	2	2	2	2
220726	Ventilator weatherstrip	1	1	1	1	1	1	1	1	1	1

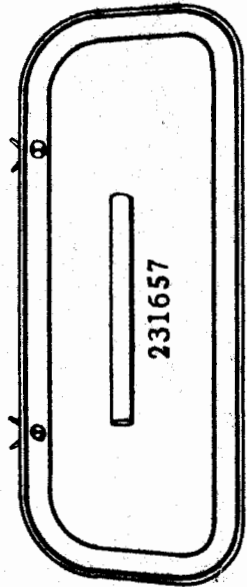

231657

220717

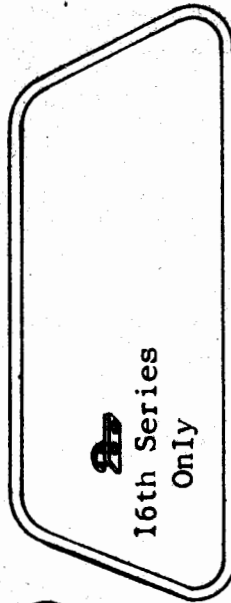

16th Series Only

220726

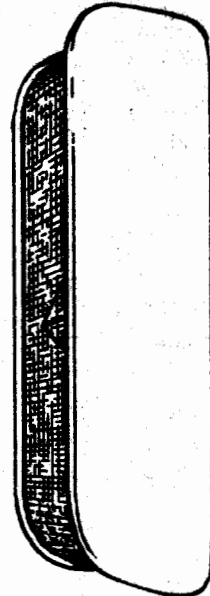

220711
235428

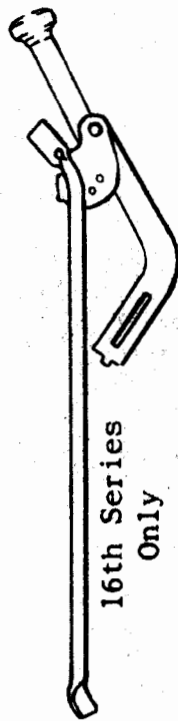

16th Series Only



16th Series Only

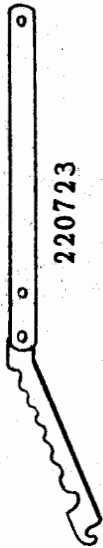

220723

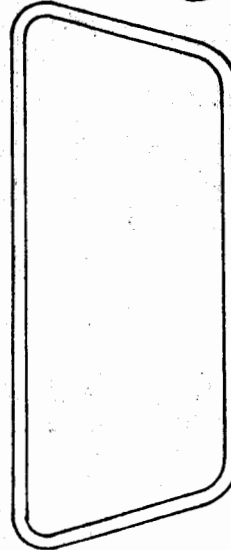

16th Series Only

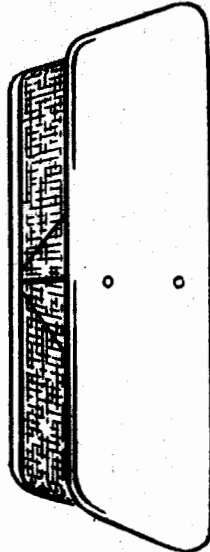

16th Series Only



16th Series Only



199374

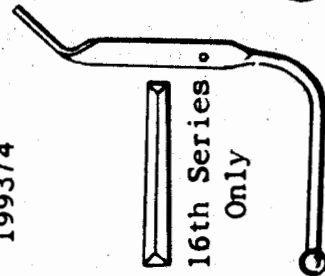

16th Series Only

220718



206188



307088 16th Series
Only



111687



220783

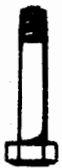

235434



224905



224910



231938

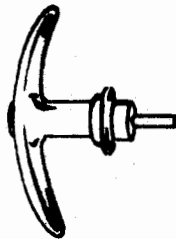

16th Series
Only

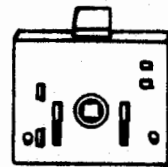

176282

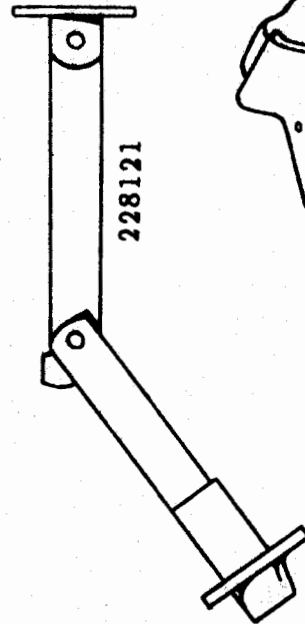

228121

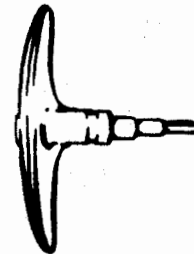

224828



231989-235147



231937

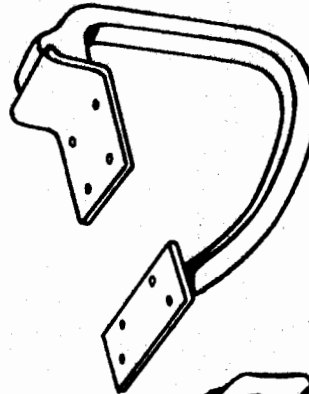

226065

226066

Piece No.	Name	(15th Series)									
		1012-32 5 P. Formal Sedan	1003-13-23-33 5 P. Tour. Sedan	1014-34 7 P. Tour. Sedan	1015-35 7 P. Tour. Sedan Lim	1016-36 5 P. Club Sedan	1017-37 5 P. Coupe	1018-38 2-4 P. Coupe	1019-39 2-4 P. Conv. Coupe	1063-73 5 P. Conv. Sedan	1007-27 5 P. Victoria
No. Required											
WHEEL COMPARTMENT											
226285	Wheel compartment door assembly	-	-	-	-	-	1	-	-	-	1
224973	Wheel compartment door brace assembly--left.	-	-	-	-	-	1	-	-	-	1
228121	Wheel compartment door brace assembly--right	-	-	-	-	-	1	-	-	-	1
5747	Screw 1/4-28 x 1-5/8 flat hd.	-	-	-	-	-	2	-	-	-	-
5676	Screw No. 10-32 x 3/8 rnd. hd.	-	-	-	-	-	2	-	-	-	-
62065	Washer 1/4 plain special	-	-	-	-	-	2	-	-	-	-
5500	Lockwasher 3/16	-	-	-	-	-	2	-	-	-	-
7003	Nut No. 10-32	-	-	-	-	-	2	-	-	-	-
5502	Lockwasher 1/4	-	-	-	-	-	2	-	-	-	-
7004	Nut 1/4-28	-	-	-	-	-	2	-	-	-	-
111687	Wheel compartment door bumper	-	-	-	-	-	2	-	-	-	2
224840	Wheel compartment door drain gutter assembly	-	-	-	-	-	1	-	-	-	1
226065	Wheel compartment door hinge assembly--right	-	-	-	-	-	1	-	-	-	1
226066	Wheel compartment door hinge assembly--left.	-	-	-	-	-	1	-	-	-	1
8221	Screw 1/4-28 x 1-5/16 flat hd.	-	-	-	-	-	8	-	-	-	-
220783	Wheel compartment door hinge screw 5/16-24 x 1-1/2 hex. hd.	-	-	-	-	-	2	-	-	-	-
5504	Lockwasher 5/16	-	-	-	-	-	2	-	-	-	-
176282	Wheel compartment door lock	-	-	-	-	-	1	-	-	-	1
224828	Wheel compartment door lock handle (with key lock)	-	-	-	-	-	1	-	-	-	1
206188	Wheel compartment door lock handle attaching plate (locking handle)	-	-	-	-	-	1	-	-	-	1
307088	Wheel compartment door lock handle cylinder lock	-	-	-	-	-	1	-	-	-	1
224905	Wheel compartment door lock handle escut- cheon plate	-	-	-	-	-	1	-	-	-	1
235434	Wheel compartment door lock handle escut- cheon plate gasket	-	-	-	-	-	1	-	-	-	1
220963	Wheel compartment door lock handle screw	-	-	-	-	-	1	-	-	-	-
185236	Wheel compartment door lock handle screw washer	-	-	-	-	-	1	-	-	-	-
224910	Wheel compartment door lock striker	-	-	-	-	-	1	-	-	-	1
224811	Wheel compartment door panel	-	-	-	-	-	1	-	-	-	1
226269	Wheel compartment door weatherstrip--long	-	-	-	-	-	1	-	-	-	1
226286	Wheel compartment door weatherstrip--short	-	-	-	-	-	1	-	-	-	1
231937	Wheel compartment tire clamp	1	1	1	1	1	1	-	-	1	1
231938	Wheel compartment tire clamp bolt	1	1	1	1	1	1	-	-	1	1
235147	Wheel compartment tire clamp bolt bracket assembly	1	1	1	1	-	-	-	-	1	-
231989	Wheel compartment tire clamp bolt bracket assembly	-	-	-	-	1	1	-	-	-	1
7824	Screw 1/4-28 x 5/8 hex. hd.	4	4	4	4	4	4	-	-	4	4
5502	Lockwasher 1/4	4	4	4	4	4	4	-	-	4	4
7004	Nut 1/4-28	4	4	4	4	4	4	-	-	4	4
231986	Wheel compartment tire stop	2	2	2	2	2	2	-	-	-	-
7824	Screw 1/4-28 x 5/8 hex. hd.	4	4	4	4	4	4	-	-	-	-
5502	Lockwasher 1/4	4	4	4	4	4	4	-	-	-	-
62065	Washer 1/4	4	4	4	4	4	4	-	-	-	-

Piece No.	Name (15th Series)	No. Required									
		1012-32 S P. Formal Sedan	1003-13-23-33 S P. Tour. Sedan	1014-34 7 P. Tour. Sedan	1015-35 7 P. Tour. Sedan Lim.	1016-36 S P. Club Sedan	1017-37 S P. Coupe	1018-38 2-4 P. Coupe	1019-39 2-4 P. Conv Coupe	1063-73 S P. Conv. Sedan	1007-27 S P. Victoria
WINDSHIELD											
227673	Windshield--base	-	-	-	-	-	-	-	1	1	1
5524	Screw 5/16-24 x 1-3/4 flat hd.	-	-	-	-	-	-	-	6	-	-
6126	Screw 5/16-24 x 1-7/8 flat hd.	-	-	-	-	-	-	-	1	-	-
202909	Screw 5/16-24 x 1-1/2 flat hd.	-	-	-	-	-	-	-	2	-	-
229346	Windshield base liner	-	-	-	-	-	-	-	1	-	-
236619	Windshield cleaner hose (Supersedes 236704) ..	-	-	-	-	-	-	-	1	1	1
224435	Windshield cleaner hose	1	1	1	1	1	1	1	-	-	-
227767	Windshield cleaner control cable assembly ..	-	-	-	-	-	-	-	-	2	2
220853	Windshield cleaner driver--left assembly ...	1	1	1	1	1	1	1	-	-	-
220852	Windshield cleaner driver--right assembly ..	1	1	1	1	1	1	1	-	-	-
5667	Screw No. 10-32 x 5/8 rnd. hd.	4	4	4	4	4	4	4	-	-	-
5935	Lockwasher 3/16 (Shakeproof)	4	4	4	4	4	4	4	-	-	-
220851	Pin 3/16 yoke end	1	1	1	1	1	1	1	-	-	-
224669	Windshield cleaner driver assembly washer ..	1	1	1	1	1	1	1	-	-	-
224670	Windshield cleaner driver assembly washer ..	1	1	1	1	1	1	1	-	-	-
4690	Pin 1/16 x 3/8 cotter	1	1	1	1	1	1	1	-	-	-
220855	Windshield cleaner driver pinion assembly ..	2	2	2	2	2	2	2	-	-	-
6451	Screw No. 6-32 x 5/8 rnd. hd.	4	4	4	4	4	4	4	-	-	-
3516	Lockwasher No. 6	4	4	4	4	4	4	4	-	-	-
220854	Windshield cleaner driver pinion assembly gasket	2	2	2	2	2	2	2	-	-	-
236706	Windshield cleaner motor--right (Supersedes 227770)	-	-	-	-	-	-	-	1	1	1
236707	Windshield cleaner motor--left (Supersedes 227771)	-	-	-	-	-	-	-	1	1	1
231705	Windshield cleaner motor	1	1	1	1	1	1	1	-	-	-
5676	Screw No. 10-32 x 3/8 rnd. hd. (Make from 5772)	2	2	2	2	2	2	2	-	-	-
5966	Screw No. 10-32 x 7/8 fill. hd. (Make from 5814)	-	-	-	-	-	-	-	4	-	-
5935	Lockwasher 3/16 (Shakeproof)	2	2	2	2	2	2	2	4	-	-
236712	Windshield cleaner motor bracket geared and mounting bracket assembly	-	-	-	-	-	-	-	2	2	2
225148	Windshield cleaner motor bracket geared and mounting bracket assembly screw No. 10-32 x 1/2 rnd. hd.	-	-	-	-	-	-	-	8	-	-
5500	Lockwasher 3/16	-	-	-	-	-	-	-	8	-	-
101200	Washer 3/16 plain	-	-	-	-	-	-	-	X	-	-
236698	Windshield cleaner motor mounting bracket ..	-	-	-	-	-	-	-	2	2	2
224426	Windshield cleaner motor operating lever ferrule	1	1	1	1	1	1	1	-	-	-
236711	Windshield cleaner motor pivot shaft (Supersedes 237783)	-	-	-	-	-	-	-	2	2	2
227291	Windshield cleaner motor pivot shaft screw washer	-	-	-	-	-	-	-	2	-	-
39403	Windshield cleaner pillar tube anti-squeak tape	x	x	x	x	x	x	x	-	-	-
204683	Windshield cleaner pillar tube clip	1	1	1	1	1	1	1	-	-	-
157477	Windshield cleaner pillar tube union nut ...	1	1	1	1	1	1	1	-	-	-
236699	Windshield cleaner tee conn. (Supersedes 227764)	-	-	-	-	-	-	-	1	1	1
177851	Windshield cleaner pillar tube (flared tube connection) adapter	1	1	1	1	1	1	1	-	-	-
236701	Windshield cleaner tube right assembly (Supersedes 227760)	-	-	-	-	-	-	-	1	1	1

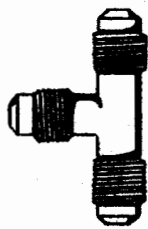

236699



16th Series Only

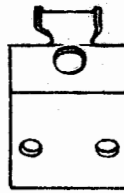

16th Series Only



236711



16th Series Only



224426



220854

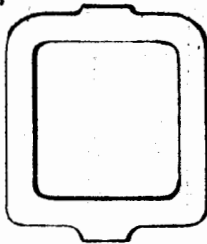

16th Series Only

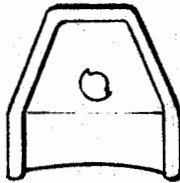

16th Series Only



16th Series Only



16th Series Only



16th Series Only

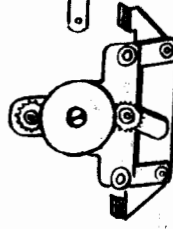

236712

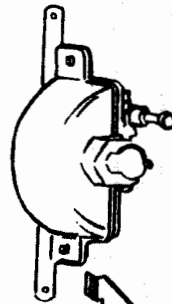

231705



311090

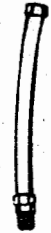

16th Series Only



16th Series Only

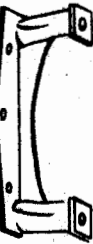

16th Series Only



16th Series Only

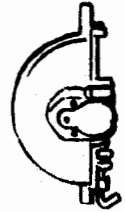

236706-7



16th Series Only



220855



236698



16th Series Only

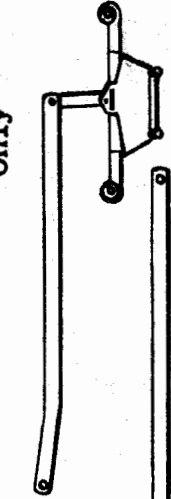

220852
220853



227767



16th Series Only



220860-- 227780



16th Series Only

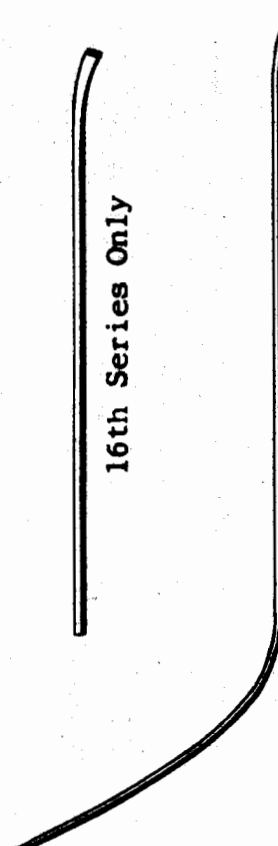

16th Series Only

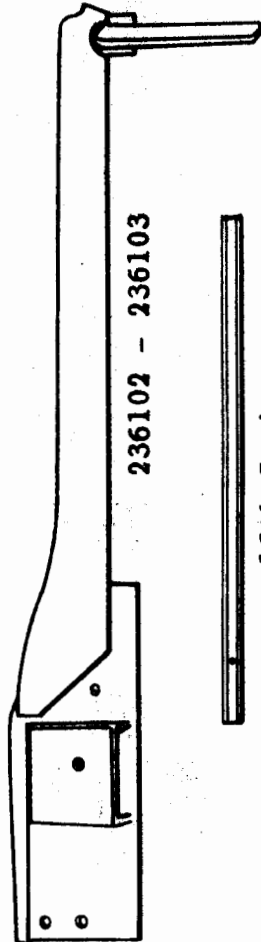

16th Series Only

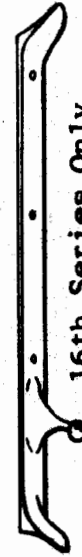

16th Series Only

Piece No.	Name (15th Series)	No. Required									
		1012-32 5 P. Formal Sedan	1003-13-23-33 5 P. Tour. Sedan	1014-34 7 P. Tour. Sedan	1015-35 7 P. Tour. Sedan Lim.	1016-36 5 P. Club Sedan	1017-37 5 P. Coupe	1018-38 2-4 P. Coupe	1019-39 2-4 P. Conv. Coupe	1063-73 5 P. Conv. Sedan	1007-27 5 P. Victoria
236703	Windshield cleaner tube left assembly (Supersedes 227761)	-	-	-	-	-	-	-	1	1	1
227457	Windshield cleaner tube intermediate assembly	-	-	-	-	-	-	-	1	1	1
143360	Windshield cleaner tube clip	-	-	-	-	-	-	-	2	4	4
210070	Windshield cleaner vacuum pump dash connection	1	1	1	1	1	1	1	1	1	1
7007	Nut 7/16-20	1	1	1	1	1	1	1	1	1	1
5806	Lockwasher 7/16 (Shakeproof)	1	1	1	1	1	1	1	1	1	1
3883	Plain washer 7/16	1	1	1	1	1	1	1	1	1	1
232920	Windshield cleaner vacuum pump to dash con- nection tube assembly (Used on 1003-12-13- 14-15-16-17-18-19-1007-1063)	1	1	1	1	1	1	1	1	1	1
232921	Windshield cleaner vacuum pump to dash con- nection tube assembly (Used on 1023-32-33- 34-35-36-37-38-39-1027-1073)	1	1	1	1	1	1	1	1	1	1
6399	Union nut 1/4 flared tube (to dash connection)	1	1	1	1	1	1	1	1	1	1
6344	Nut 1/4 flared tube (inverted weather- head) (to vacuum pump hose)	1	1	1	1	1	1	1	1	1	1
6279	Connector elbow 1/4 flared tube (inverted weatherhead) (vacuum pump hose)	1	1	1	1	1	1	1	1	1	1
196973	Clip (to frame) (Used on 1003-12-13-14- 15-16-17-18-19-07-63)	1	1	1	1	1	1	1	1	1	1
70128	Clip (to dash) (Used on 1023-32-33-34- 35-36-37-38-39-1027-1073)	1	1	1	1	1	1	1	1	1	1
234975	Clip (to oil gauge tube) (Used on 1023- 32-33-34-35-36-37-38-39-27-73)	2	2	2	2	2	2	2	2	2	2
229302	Screw 1/4-20 x 1/2 hex. hd. (Used on 1003-12-13-14-15-16-17-18-19-07-63)	1	1	1	1	1	1	1	1	1	1
7004	Nut 1/4-28 (Used on 1023-32-33-34-35- 36-37-38-39-27-73)	1	1	1	1	1	1	1	1	1	1
5502	Lockwasher 1/4 (Used on 1023-32-33-34- 35-36-37-38-39-27-73)	1	1	1	1	1	1	1	1	1	1
228939	Windshield cleaner vacuum pump to dash connection tube assembly hose (Used on 1003-12-13-14-15-16-17-18-19-07-63)	1	1	1	1	1	1	1	1	1	1
311090	Windshield cleaner vacuum regulator assembly	-	-	-	-	-	-	-	2	2	2
7003	Nut No. 10-32	-	-	-	-	-	-	-	2	-	-
5500	Lockwasher 3/16	-	-	-	-	-	-	-	2	-	-
235505	Windshield cleaner vacuum regulator knob and control cable assembly (Supersedes 311365)	-	-	-	-	-	-	-	2	2	2
311085	Windshield cleaner vacuum regulator knob and control cable clip	-	-	-	-	-	-	-	2	2	2
5676	Screw No. 10-32 x 3/8 rnd. hd.	-	-	-	-	-	-	-	2	-	-
5500	Lockwasher 3/16	-	-	-	-	-	-	-	2	-	-
220860	Windshield cleaner wiper	2	2	2	2	2	2	2	-	-	-
227780	Windshield cleaner wiper	-	-	-	-	-	-	-	2	2	2
236714	Windshield cleaner wiper arm--right (Supersedes 236192)	-	-	-	-	-	-	-	1	1	1

Piece No.	(15th Series) Name	No. Required									
		1012-32 S P. Formal Sedan	1003-13-23-33 S P. Tour. Sedan	1014-34 7 P. Tour. Sedan	1015-35 7 P. Tour. Sedan Lim	1016-36 S P. Club Sedan	1017-37 S P. Coupe	1018-38 2-4 P. Coupe	1019-39 2-4 P. Conv. Coupe	1063-73 S P. Conv. Sedan	1007-27 S P. Victoria
236715	Windshield cleaner wiper arm--left (Supersedes 236193)	-	-	-	-	-	-	-	1	1	1
220859	Windshield cleaner wiper arm	2	2	2	2	2	2	2	-	-	-
224668	Windshield cleaner wiper arm nut	2	2	2	2	2	2	2	2	2	2
235183	Windshield finishing moulding assembly	1	1	1	1	1	1	1	-	-	-
8028	Screw No. 6-40 x 1 oval hd.	4	4	4	4	4	4	4	-	-	-
218522	Windshield finishing moulding assembly screw ferrule No. 6	10	10	10	10	10	10	10	-	-	-
227671	Windshield finishing moulding lower	-	-	-	-	-	-	-	1	1	1
230586	Windshield finishing moulding side--right ..	-	-	-	-	-	-	-	1	1	1
230587	Windshield finishing moulding side--left ...	-	-	-	-	-	-	-	1	1	1
227918	Windshield finishing moulding side screw (special No. 8 head)	-	-	-	-	-	-	-	6	-	-
227670	Windshield finishing moulding upper	-	-	-	-	-	-	-	1	1	1
227918	Windshield finishing moulding upper screw No. 10-32 x 1-1/8 oval hd.	-	-	-	-	-	-	-	2	-	-
227917	Windshield finishing moulding upper screw No. 10-32 x 1-3/8 oval hd.	-	-	-	-	-	-	-	3	-	-
235347	Windshield finishing moulding defroster hole cover	1	1	1	1	1	1	1	-	-	-
5766	Screw No. 6-40 x 3/8 oval hd.	2	2	2	2	2	2	2	-	-	-
218522	Screw ferrule No. 6	2	2	2	2	2	2	2	-	-	-
220844	Windshield finishing rim	1	1	1	1	1	1	1	-	-	-
227666	Windshield finishing rim lower	-	-	-	-	-	-	-	1	1	1
227667	Windshield finishing rim upper	-	-	-	-	-	-	-	1	1	1
227664	Windshield finishing rim side right	-	-	-	-	-	-	-	1	1	1
227665	Windshield finishing rim side left	-	-	-	-	-	-	-	1	1	1
220846	Windshield glass	1	1	1	1	1	1	1	-	-	-
227672	Windshield glass	-	-	-	-	-	-	-	1	1	1
220845	Windshield glass cushion	1	1	1	1	1	1	1	-	-	-
227819	Windshield glass cushion--upper	-	-	-	-	-	-	-	1	1	1
227822	Windshield glass cushion--lower	-	-	-	-	-	-	-	1	1	1
227820	Windshield glass cushion--side	-	-	-	-	-	-	-	2	-	-
227820	Windshield glass cushion--side right	-	-	-	-	-	-	-	-	1	1
227821	Windshield glass cushion--side left	-	-	-	-	-	-	-	-	1	1
235221	Windshield glass retainer	1	1	1	1	1	1	1	-	-	-
223142	Windshield glass retainer screw No. 6-32 x 1/4 flat hd.	-	-	-	-	-	-	-	16	-	-
220715	Windshield glass retainer screw No. 6 x 3/8 binding hd. type A	15	15	15	15	15	15	15	-	-	-
227370	Windshield glass retainer--upper	-	-	-	-	-	-	-	1	1	1
227461	Windshield glass retainer--lower	-	-	-	-	-	-	-	1	1	1
227462	Windshield glass retainer side--right	-	-	-	-	-	-	-	1	1	1
227463	Windshield glass retainer side--left	-	-	-	-	-	-	-	1	1	1
227619	Windshield header	-	-	-	-	-	-	-	1	1	1
227915	Screw 5/16-24 x 17/32 flat hd.	-	-	-	-	-	-	-	10	-	-
204683	Windshield header cleaner pillar tube clip .	2	2	2	2	2	2	2	-	-	-
218322	Windshield header dowel anti-rattler	4	4	4	4	4	4	4	-	-	-
236102	Windshield stanchion assembly--right	-	-	-	-	-	-	-	1	1	1
236103	Windshield stanchion assembly--left	-	-	-	-	-	-	-	1	1	1
228232	Screw 7/16-14 x 2-1/2 hex. hd.	-	-	-	-	-	-	-	2	-	-
5508	Lockwasher 7/16	-	-	-	-	-	-	-	2	-	-
227723	Washer	-	-	-	-	-	-	-	2	2	2
236061	Screw 5/16-24 x 2-1/2 flat hd. (spl.) .	-	-	-	-	-	-	-	4	-	-
236062	Screw 5/16-24 x 5 flat hd. (spl.)	-	-	-	-	-	-	-	2	-	-
236059	Screw 5/16-24 x 1-3/4 flat hd. (spl.) .	-	-	-	-	-	-	-	2	-	-

Piece No.	Name	(15th Series)									
		1012-32 5 P. Formal Sedan	1003-13-23-33 5 P. Tour. Sedan	1014-34 7 P. Tour. Sedan	1015-35 7 P. Tour. Sedan Lim.	1016-36 5 P. Club Sedan	1017-37 5 P. Coupe	1018-38 2-4 P. Coupe	1019-39 2-4 P. Conv. Coupe	1063-73 5 P. Conv. Sedan	1007-27 5 P. Trucks
		No. Required									
5071	Washer 7/16	-	-	-	-	-	-	-	-	2	-
5899	Lockwasher 5/16 countersunk (Shakeproof)	-	-	-	-	-	-	-	-	2	-

TRIMMING

To avoid errors due to difference in texture and shade, please furnish sample when ordering trimming material.

233540	Assembly--carpet floor front (Mohair) (L.H. drive) (Used on 1003-13-14-16)	-	1	1	-	1	-	-	-	-	-
233050	Assembly--carpet floor front (Woolen) (L.H. drive) (Used on 1003-13-14-16)	-	1	1	-	1	-	-	-	-	-
233541	Assembly--carpet floor front (Mohair) (L.H. drive) (Used on 1012-1015)	1	-	-	1	-	-	-	-	-	-
233051	Assembly--carpet floor front (Woolen) (L.H. drive) (Used on 1012-1015)	1	-	-	1	-	-	-	-	-	-
233656	Assembly--carpet floor front (Mohair) (L.H. drive)	-	-	-	-	-	-	-	1	-	-
233052	Assembly--carpet front floor (Used on 1032-35)	1	-	-	1	-	-	-	-	-	-
233053	Assembly--carpet floor front (Used on 1038)	-	-	-	-	-	-	1	-	-	-
233054	Assembly--carpet floor front (Used on 1023-33-34-36)	-	1	1	-	1	-	-	-	-	-
233055	Assembly--carpet floor front (Used on 1019) (Woolen) (L.H. drive)	-	-	-	-	-	-	-	1	-	-
233542	Assembly--carpet floor front (Mohair) (L.H. drive) (Used on 1017)	-	-	-	-	-	1	-	-	-	-
233056	Assembly--carpet floor front (Woolen) (L.H. drive) (Used on 1017)	-	-	-	-	-	1	-	-	-	-
233057	Assembly--carpet floor front (Used on 1039) (Woolen)	-	-	-	-	-	-	-	1	-	-
233058	Assembly--carpet floor front (Used on 1037)	-	-	-	-	-	1	-	-	-	-
233543	Assembly--carpet floor front (Mohair) (L.H. drive) (Used on 1018)	-	-	-	-	-	-	1	-	-	-
233059	Assembly--carpet floor front (Woolen) (L.H. drive) (Used on 1018)	-	-	-	-	-	-	1	-	-	-
233589	Assembly--carpet floor front (Mohair) (R.H. drive)	1	-	-	1	-	-	-	-	-	-
233490	Assembly--carpet floor front (Woolen) (R.H. drive)	1	-	-	1	-	-	-	-	-	-
233492	Assembly--carpet floor front (Woolen) (R.H. drive)	-	-	-	-	-	-	-	1	-	-
233659	Assembly--carpet floor front (Mohair) (R.H. drive)	-	-	-	-	-	-	-	1	-	-
233588	Assembly--carpet floor front (Mohair) (R.H. drive)	-	-	-	-	-	1	-	-	-	-
233494	Assembly--carpet floor front (Woolen) (R.H. drive)	-	-	-	-	-	1	-	-	-	-
233590	Assembly--carpet floor front (Mohair) (R.H. drive)	-	-	-	-	-	-	1	-	-	-
233491	Assembly--carpet floor front (Woolen) (R.H. drive)	-	-	-	-	-	-	1	-	-	-
233591	Assembly--carpet floor front (Mohair) (R.H. drive)	-	1	1	-	1	-	-	-	-	-

Piece No.	(15th Series) Name	No. Required									
		1012-32 5 P. Formal Sedan	1003-13-23-33 5 P. Tour. Sedan	1014-34 7 P. Tour. Sedan	1015-35 7 P. Tour. Sedan Lim.	1016-36 5 P. Club Sedan	1017-37 5 P. Coupe	1018-38 2-4 P. Coupe	1019-39 2-4 P. Conv. Coupe	1063-73 5 P. Conv. Sedan	1007-27 5-P. Victoria
233493	Assembly--carpet floor front (Woolen) (R.H. drive)	-	1	1	-	1	-	-	-	-	-
233544	Assembly--carpet floor rear (Mohair) (Used on 1014)	-	-	1	-	-	-	-	-	-	-
233164	Assembly--carpet floor rear (Woolen) (Used on 1014)	-	-	1	-	-	-	-	-	-	-
233545	Assembly--carpet floor rear (Mohair) (Used on 1015)	-	-	-	1	-	-	-	-	-	-
226953	Assembly--carpet floor rear (Woolen) (Used on 1015)	-	-	-	1	-	-	-	-	-	-
233278	Assembly--carpet floor rear (Used on 1034)	-	-	1	-	-	-	-	-	-	-
218183	Assembly--carpet floor rear (Used on 1035)	-	-	-	1	-	-	-	-	-	-
233546	Assembly--carpet floor rear (Mohair) (Used on 1003)	-	1	-	-	-	-	-	-	-	-
233165	Assembly--carpet floor rear (Woolen) (Used on 1003)	-	1	-	-	-	-	-	-	-	-
233279	Assembly--carpet floor rear (Used on 1023)	-	1	-	-	-	-	-	-	-	-
233547	Assembly--carpet floor rear (Mohair) (Used on 1013)	-	1	-	-	-	-	-	-	-	-
233166	Assembly--carpet floor rear (Woolen) (Used on 1013)	-	1	-	-	-	-	-	-	-	-
233280	Assembly--carpet floor rear (Used on 1033)	-	1	-	-	-	-	-	-	-	-
233548	Assembly--carpet floor rear (Mohair) (Used on 1016)	-	-	-	-	1	-	-	-	-	-
233167	Assembly--carpet floor rear (Woolen) (Used on 1016)	-	-	-	-	1	-	-	-	-	-
233549	Assembly--carpet floor rear (Mohair) (Used on 1012)	1	-	-	-	-	-	-	-	-	-
226955	Assembly--carpet floor rear (Woolen) (Used on 1012)	1	-	-	-	-	-	-	-	-	-
233487	Assembly--carpet floor rear (Used on 1032)	1	-	-	-	-	-	-	-	-	-
233281	Assembly--carpet floor rear (Used on 1036)	-	-	-	-	1	-	-	-	-	-
229775	Assembly--carpet floor rear (Used on 1037)	-	-	-	-	1	-	-	-	-	-
233550	Assembly--carpet floor rear (Mohair) (Used on 1017)	-	-	-	-	1	-	-	-	-	-
229773	Assembly--carpet floor rear (Woolen) (Used on 1017)	-	-	-	-	1	-	-	-	-	-
233551	Assembly--carpet folding seat floor (Mohair) (Used on 1014)	-	-	2	-	-	-	-	-	-	-
179586	Assembly--carpet folding seat floor (Woolen) (Used on 1014)	-	-	2	-	-	-	-	-	-	-
233552	Assembly--carpet folding seat floor (Mohair) (Used on 1015)	-	-	-	2	-	-	-	-	-	-
229549	Assembly--carpet folding seat floor (Woolen) (Used on 1015)	-	-	-	2	-	-	-	-	-	-
233553	Assembly--carpet folding seat heel board (Mohair) (Used on 1014-15)	-	-	2	2	-	-	-	-	-	-
226695	Assembly--carpet folding seat heel board (Woolen) (Used on 1014-15)	-	-	2	2	-	-	-	-	-	-
226432	Assembly--carpet floor rear compartment (Used on 1037)	-	-	-	-	1	-	-	-	-	-
233619	Assembly--carpet rear compartment floor pan (Use with side wheel carrier) (Use with body 1037)	-	-	-	-	1	-	-	-	-	-
229706	Assembly--carpet rumble seat compartment floor (Used on 1019)	-	-	-	-	-	-	1	-	-	-

Piece No.	Name	(15th Series)										No. Required	
		1012-32 S P. Formal Sedan	1003-13-23-33 S P. Tour. Sedan	1014-34 7 P. Tour. Sedan	1015-35 7 P. Tour. Sedan Lim	1016-36 S P. Club Sedan	1017-37 S P. Coupe	1018-38 2-4 P. Coupe	1019-39 2-4 P. Conv. Coupe	1063-73 S P. Conv Sedan	1007-27 S P. Victoria		
229705	Assembly--carpet rumble seat compartment floor (Used on 1039)	-	-	-	-	-	-	-	-	-	1	-	-
229585	Assembly--carpet rumble seat compartment floor (Used on 1018)	-	-	-	-	-	-	-	-	1	-	-	-
226437	Assembly--carpet rumble seat compartment floor (Used on 1038)	-	-	-	-	-	-	-	-	1	-	-	-
317235	Assembly--carpet trunk compartment floor (Used on 1036)	-	-	-	-	1	-	-	-	-	-	-	-
233514	Assembly--carpet trunk compartment floor (Use with side wheel carrier) (Used on 1032-23-1033-34-35)	1	1	1	1	-	-	-	-	-	-	-	-
317234	Assembly--carpet trunk compartment floor (Used on 1032-23-33-34-35)	1	1	1	1	-	-	-	-	-	-	-	-
233515	Assembly--carpet trunk compartment floor (Used with side wheel carrier) (Used on 1036)	-	-	-	-	1	-	-	-	-	-	-	-
233027	Assembly--door trimming front--left (Used on 1012-13-14)	1	1	1	-	-	-	-	-	-	-	-	-
233029	Assembly--door trimming front--left (Used on 1003-16)	-	1	-	-	1	-	-	-	-	-	-	-
233017	Assembly--door trimming front--left (Used on 1037-38)	-	-	-	-	-	1	1	-	-	-	-	-
233035	Assembly--door trimming front--left (Used on 1019)	-	-	-	-	-	-	-	-	-	1	-	-
233011	Assembly--door trimming front--left (Used on 1032-33-34)	1	1	1	-	-	-	-	-	-	-	-	-
233018	Assembly--door trimming front--left (Used on 1039)	-	-	-	-	-	-	-	-	-	1	-	-
233013	Assembly--door trimming front--left (Used on 1023-36)	-	1	-	-	1	-	-	-	-	-	-	-
233031	Assembly--door trimming front--left (Used on 1015)	-	-	-	1	-	-	-	-	-	-	-	-
233015	Assembly--door trimming front--left (Used on 1035)	-	-	-	1	-	-	-	-	-	-	-	-
233033	Assembly--door trimming front--left (Used on 1017-18)	-	-	-	-	-	1	1	-	-	-	-	-
233028	Assembly--door trimming front--right (Used on 1003-16)	-	1	-	-	1	-	-	-	-	-	-	-
233034	Assembly--door trimming front--right (Used on 1019)	-	-	-	-	-	-	-	-	-	1	-	-
233016	Assembly--door trimming front--right (Used on 1037-38)	-	-	-	-	-	1	1	-	-	-	-	-
233026	Assembly--door trimming front--right (Used on 1012-13-14)	1	1	1	-	-	-	-	-	-	-	-	-
233019	Assembly--door trimming front--right (Used on 1039)	-	-	-	-	-	-	-	-	-	1	-	-
233010	Assembly--door trimming front--right (Used on 1032-33-34)	1	1	1	-	-	-	-	-	-	-	-	-
233032	Assembly--door trimming front--right (Used on 1017-18)	-	-	-	-	-	1	1	-	-	-	-	-
233012	Assembly--door trimming front--right (Used on 1023-36)	-	1	-	-	1	-	-	-	-	-	-	-
233014	Assembly--door trimming front--right (Used on 1035)	-	-	-	1	-	-	-	-	-	-	-	-
233030	Assembly--door trimming front--right (Used on 1015)	-	-	-	1	-	-	-	-	-	-	-	-

Piece No.	Name	(15th Series)									
		1012-32 5 P. Formal Sedan	1003-13-23-33 5 P. Tour. Sedan	1014-34 7 P. Tour. Sedan	1015-35 7 P. Tour. Sedan Lim.	1016-36 5 P. Club Sedan	1017-37 5 P. Coupe	1018-38 2-4 P. Coupe	1019-39 2-4 P. Conv. Coupe	1063-73 5 P. Conv. Sedan	1007-27 5 P. Victoria
		No. Required									
233091	Assembly--door trimming rear--left (Used on 1003)	-	1	-	-	-	-	-	-	-	-
233021	Assembly--door trimming rear--left (Used on 1032-33)	1	1	-	-	-	-	-	-	-	-
233093	Assembly--door trimming rear--left (Used on 1014-15-16)	-	-	1	1	1	-	-	-	-	-
233025	Assembly--door trimming rear--left (Used on 1023)	-	1	-	-	-	-	-	-	-	-
233089	Assembly--door trimming rear--left (Used on 1012-13)	1	1	-	-	-	-	-	-	-	-
233023	Assembly--door trimming rear--left (Used on 1034-35-36)	-	-	1	1	1	-	-	-	-	-
233090	Assembly--door trimming rear--right (Used on 1003)	-	1	-	-	-	-	-	-	-	-
233020	Assembly--door trimming rear--right (Used on 1032-33)	1	1	-	-	-	-	-	-	-	-
233092	Assembly--door trimming rear--right (Used on 1014-15-16)	-	-	1	1	1	-	-	-	-	-
233088	Assembly--door trimming rear--right (Used on 1012-13)	1	1	-	-	-	-	-	-	-	-
233024	Assembly--door trimming rear--right (Used on 1023)	-	1	-	-	-	-	-	-	-	-
233022	Assembly--door trimming rear--right (Used on 1034-35-36)	-	-	1	1	1	-	-	-	-	-
233489	Assembly--folding top dust cover	-	-	-	-	-	-	1	-	-	-
226649	Assembly--head lining (Specify set number)	1	-	-	-	-	-	-	-	-	-
226118	Assembly--head lining (Specify set number) (Used on 1003-23)	-	1	-	-	-	-	-	-	-	-
226650	Assembly--head lining (Specify set number) (Used on 1013-33)	-	1	-	-	-	-	-	-	-	-
226188	Assembly--head lining (Specify set number)	-	-	1	-	-	-	-	-	-	-
226651	Assembly--head lining (Specify set number)	-	-	-	-	1	-	-	-	-	-
226652	Assembly--head lining (Specify set number)	-	-	-	-	-	1	-	-	-	-
226653	Assembly--head lining (Specify set number)	-	-	-	-	-	-	1	-	-	-
226654	Assembly--head lining front compartment (Specify set number)	-	-	-	1	-	-	-	-	-	-
226655	Assembly--head lining rear (Specify set number)	-	-	-	1	-	-	-	-	-	-
226425	Assembly--pad folding seat compartment floor (Used on 1034-35)	-	-	2	2	-	-	-	-	-	-
233298	Assembly--pad front floor (Used on 1023-33-34-36)	-	1	1	-	1	-	-	-	-	-
229748	Assembly--pad front floor (Used on 1038-39)	-	-	-	-	-	-	1	1	-	-
229790	Assembly--pad front floor (Used on 1037)	-	-	-	-	-	1	-	-	-	-
226656	Assembly--pad front floor (Used on 1032-35)	1	-	-	1	-	-	-	-	-	-
229760	Assembly--pad rumble seat compartment bottom (Used on 1038-39)	-	-	-	-	-	-	1	1	-	-
139910	Binding cloth wire-on (Pattern Vogt No. 935) (Specify set number) (Used on 1012-1003-13-14-15-16-17-18)	x	x	x	x	x	x	x	-	-	-
233353	Binding cloth wire-on (Pattern Vogt No. 936) (Specify set number) (Used on 1032-23-33-34-35-36-1038)	x	x	x	x	x	-	x	-	-	-
228405	Binding cloth wire-on (Top fabric) (Specify set number)	-	-	-	-	-	-	-	x	-	-

Piece No.	Name (15th Series)	No. Required									
		1012-32 5 P. Formal Sedan	1003-13-23-33 5 P. Tour. Sedan	1014-34 7 P. Tour. Sedan	1015-35 7 P. Tour. Sedan Lim	1016-36 6 P. Club Sedan	1017-37 5 P. Coupe	1018-38 2-4 P. Coupe	1019-39 2-4 P. Conv. Coupe	1063-73 5 P. Conv. Sedan	1007-77 5 P. Victoria
167438	Binding cloth wire-on (Cordless) (1/2" wide) (Pattern Vogt No. 935) (Specify set number) (Used on 1012-1003-13-14-15-16-17-18)	X	X	X	X	X	X	X	-	-	-
233354	Binding cloth wire-on (Cordless) (1/2" wide) (Pattern Vogt No. 936) (Specify set number) (Used on 1032-23-33-34-35-36-37-38)	X	X	X	X	X	X	X	-	-	-
156596	Binding lace 7/16" (Specify set number) (Used on 1023-33-34-35-36-37-39)	-	X	X	X	X	X	-	X	-	-
312435	Binding carpet 1" wide (Herring bone weave) (Specify set number) (Used on 1012-1003-13-14-15-16-1017-37)	X	X	X	X	X	X	-	-	-	-
127259	Binding carpet (Specify set number)	X	X	X	X	X	X	X	-	-	-
306536	Binding 1-1/8" bias cut--black imitation (Specify set number)	X	X	X	X	X	X	X	-	-	-
226984	Binding leather wire-on Natural Grain (Specify set number)	-	-	-	X	-	-	X	X	-	-
206731	Binding rattan 3/8" half round (Specify set number) (Used on 1023-33-34-35)	-	X	X	X	-	-	-	-	-	-
177812	Binding tip--wire-on top--left	-	-	-	-	-	-	-	X	-	-
177813	Binding tip--wire-on top--right	-	-	-	-	-	-	-	X	-	-
233265	Binding weatherstrip (Pattern Vogt No. 935) (Specify set number) (Used on 1012-1003-13-14-15-16-17-18)	X	X	X	X	X	X	X	-	-	-
233356	Binding weatherstrip (Pattern Vogt No. 936) (Specify set number) (Used on 1032-23-33-34-35-36-37-1038)	X	X	X	X	X	X	X	-	-	-
5579	Brad No. 19 x 3/4 (Taper head)	X	X	X	X	X	X	X	-	-	-
5738	Brad No. 19 x 1/2 (Taper head)	X	X	X	X	X	X	X	-	-	-
233628	Buckram 8 oz.--38" wide--Black--single ply (Used on 1014-15-1090-91)	-	-	X	X	-	-	-	-	X	X
312372	Button hold down tape (5-1/2" long) (White)	-	-	-	-	-	-	X	X	X	-
312373	Button hold down tape (6" long) (Yellow)	X	X	X	X	X	X	-	X	-	-
312374	Button hold down tape (8-3/4" long) (Purple)	-	X	X	-	X	X	-	-	X	-
233205	Button hold down tape (6-3/4" long) (Green)	X	X	X	X	-	-	X	X	X	-
233206	Button hold down tape (7-1/4" long) (Tan)	X	-	-	X	-	X	X	-	-	X
313881	Button hold down tape (5-3/4" long) (White)	-	-	-	-	-	-	-	-	X	-
236885	Button hold down tape (6-1/2" long) (Black)	-	-	-	-	-	-	-	-	-	X
236881	Button hold down tape (5-1/4" long) (Orange)	-	-	-	-	-	-	-	-	-	X
236811	Button hold down tape (7-3/4" long) (Red)	-	-	-	-	-	-	-	-	X	X
233264	Button fabric covered upholsterer clincher (Used on 1032-23-33-34-35-36-37-38)	X	X	X	X	X	X	X	-	-	-
218108	Button fabric covered upholsterer clincher (Used on 1012-1003-13-14-15-16-17-18)	X	X	X	X	X	X	X	-	-	-
218000	Button fabric covered upholsterer tufting (Used on 1012-1003-13-14-15-16-17-18)	X	X	X	X	X	X	X	-	-	-
233109	Button fabric covered upholsterer tufting (Used on 1032-23-33-34-35-36-37-38)	X	X	X	X	X	X	X	-	-	-
233534	Button--leather covered tufting (Used on 1019)	-	-	-	-	-	-	-	X	-	-
233126	Button--leather covered upholsterers clincher (Used on 1039-1073-1027)	-	-	-	-	-	-	-	X	X	X
218016	Button--leather covered upholsterers clincher (Used on 1015-19)	-	-	-	X	-	-	-	X	-	-
233596	Button--leather covered upholsterers tufting (Used on 1035-39-1073)	-	-	-	X	-	-	-	X	X	-

Piece No.	Name (15th Series)	No. Required									
		1012-32 5 P. Formal Sedan	1003-13-23-33 5 P. Tour. Sedan	1014-34 7 P. Tour. Sedan	1015-35 7 P. Tour. Sedan Lum	1016-36 5 P. Club Sedan	1017-37 5 P. Coupe	1018-38 2-4 P. Coupe	1019-39 2-4 P. Conv. Coupe	1063-73 5 P. Conv. Sedan	1007-27 5 P. Victoria
218001	Button No. 40 line upholsterers prong (Used on 1012-1003-13-14-15-16-18-19)	x	x	x	x	x	-	x	x	-	-
218162	Carpet woolen 36" wide (Used on 1012-1003-13-14-16-17-18)	x	x	x	-	x	x	x	-	-	-
113980	Carpet woolen 36" wide (Not used on 1038) ..	x	x	x	x	x	x	x	-	-	-
233269	Carpet woolen 44" wide (Used on 1013-14-15-17)	-	x	x	x	-	x	-	-	-	-
200996	Carpet rubber set 36" wide	-	-	-	-	-	x	x	x	-	-
200995	Carpet rubber set 36" wide	-	-	-	-	-	-	-	x	-	-
29651	Cloth cotton 36" wide	x	x	x	x	x	x	x	-	-	-
233267	Cloth cotton oiled 50" wide	x	x	x	x	x	x	x	x	-	-
29790	Cord window curtain guide	-	x	x	x	-	x	-	-	-	-
113822	Cord welt enameled drill	-	x	x	-	x	-	-	-	-	-
226983	Cord welt 11/16 x 3/16 leather natural grain	-	-	-	x	-	-	x	x	-	-
173243	Cord welt seaming lace 11/16 x 3/16 (Pattern Vogt No. 935) (Used on 1012-1003-13-14-15-16-17-18)	x	x	x	x	x	x	x	-	-	-
233352	Cord welt seaming lace 1/16 paper cord 1/2" flange (Pattern Vogt No. 936) (Used on 1032-23-33-34-35-36-37-38)	x	x	x	x	x	x	x	-	-	-
169249	Drill sized plain 33" wide	-	x	-	-	x	-	-	-	-	-
161787	Drill white cotton 7 oz. 36" wide	x	x	x	x	x	x	x	x	-	-
306132	Fabric Osnaburg 50" wide	x	x	x	x	x	x	x	x	-	-
200467	Fabric top material (54" wide) water repellent treated	-	-	-	-	-	-	-	x	-	-
185211	Fabric 58" upholstering (Used on 1032-23-33-34-35-36-37-38)	x	x	x	x	x	x	x	-	-	-
226913	Fabric upholstering (Mohair 54" wide) (Use when Mohair is specified) (Used on 1012-1003-13-14-15-16-17-18-1019-39)	x	x	x	x	x	x	x	x	-	-
113981	Fabric upholstering 58" wide 22 oz. body cloth (Used on 1012-1003-13-14-15-16-17-18)	x	x	x	x	x	x	x	-	-	-
115026	Fabric 60" upholstering side wall 19 oz. (Used on 1012-1003-13-14-15-16-17-18)	x	x	x	x	x	x	x	-	-	-
184863	Fabric--roof covering 45" wide turtle grain (Black finish)	x	-	-	-	-	-	-	-	-	-
218169	Fabric--roof covering 45" wide Vox grain ...	x	x	x	x	x	x	x	-	-	-
218170	Fabric--roof covering 45" wide Vox grain ...	-	x	x	x	x	x	x	-	-	-
218128	Fabric--pyroxylin coated double faced window curtain (Used on 1012-1003-13-14-15-16-17-18)	x	x	x	x	x	x	x	-	-	-
229578	Fastener eyelet long--top rear curtain	-	-	-	-	-	-	-	x	-	-
229579	Fastener eyelet washer--top rear curtain ...	-	-	-	-	-	-	-	x	-	-
229577	Fastener stud wood screw--top rear curtain (long single)	-	-	-	-	-	-	-	x	-	-
195338	Felt top bot filler	-	-	-	-	-	-	-	x	-	-
156857	Gimp 3/4 bias cut imitation leather	x	x	x	x	x	x	x	x	-	-
228406	Gimp 3/4 fabric top material	-	-	-	-	-	-	-	x	-	-
156692	Gimp (1/2" imitation black Colonial leather)	x	x	x	x	x	x	x	x	-	-
136832	Grommet No. 2 arm rest pocket	-	-	-	1	-	-	-	-	-	-
136832	Grommet No. 2 rumble seat back vent	-	-	-	-	-	-	5	5	-	-
136833	Grommet No. 2 washer arm rest pocket	-	-	-	1	-	-	-	-	-	-
136833	Grommet No. 2 washer--rumble seat back vent.	-	-	-	-	-	-	5	5	-	-
214054	Hair interlacéd 52" wide (Used on 1012-1003-13-14-15-35-16-17-18-19-39)	x	x	x	x	x	x	x	x	-	-
306188	Hog rings, Jenks & Muir or equivalent	x	x	x	-	x	x	-	-	-	-

1018/19

SERVICE PARTS LIST--PACKARD SUPER-EIGHT AND TWELVE

Trimming 337

Piece No.	Name	(15th Series)									
		1012-32 5 P. Formal Sedan	1003-13-23-33 5 P. Tour. Sedan	1014-34 7 P. Tour. Sedan	1015-35 7 P. Tour. Sedan Lim.	1016-36 5 P. Club Sedan	1017-37 5 P. Coupe	1018-38 2-4 P. Coupe	1019-39 2-4 P. Conv. Coupe	1063-73 5 P. Conv. Sedan	1007-27 5 P. Victoria
		No. Required									
314737	Hog ring (large)	x	x	x	x	x	x	x	x	-	-
214109	Leather imitation 52" wide Color Black	-	-	-	-	-	x	-	-	-	-
123507	Leather imitation	-	-	-	-	-	-	x	-	-	-
226917	Leather trimming (Natural grain)	-	-	-	x	-	x	x	x	-	-
226918	Leather imitation (Natural grain)	x	x	x	x	x	x	x	x	-	-
183986	Leather turtle grain landau 10 to 10-1/2 oz. (Black)	x	-	-	-	-	-	-	-	-	-
161778	Leather binding .020 thick (Used on 1023-33-34-35)	-	x	x	x	-	-	-	-	-	-
236781	Mat--floor front (Used on 1027-1073)	-	-	-	-	-	-	-	-	1	1
233624	Mat--rear compartment floor pan (Use with body 1017) (Use with side wheel carrier)	-	-	-	-	-	1	-	-	-	-
236780	Mat--rear floor (Used on 1073)	-	-	-	-	-	-	-	-	1	-
236743	Mat--rear floor (Used on 1027)	-	-	-	-	-	-	-	-	-	1
235260	Mat--trunk compartment floor rubber (Used on 1016)	-	-	-	-	1	-	-	-	-	-
235259	Mat--trunk compartment floor rubber (Use with side wheel carrier) (Used on 1012-1003-13-14-15)	1	1	1	1	-	-	-	-	-	-
236812	Mat--trunk compartment floor (Used on 1007) (Side wheel carrier)	-	-	-	-	-	-	-	-	-	1
236816	Mat--trunk compartment floor (Used on 1063) (Side wheel carrier)	-	-	-	-	-	-	-	-	1	-
235258	Mat--trunk compartment floor rubber (Used on 1012-1003-13-14-15)	1	1	1	1	-	-	-	-	-	-
235268	Mat--trunk compartment floor rubber (Use with side wheel carrier) (Use on 1016)	-	-	-	-	1	-	-	-	-	-
192303	Muslin rubber 54" wide (Used on 1032-23-33-34-35-36-37-38-39)	x	x	x	x	x	x	x	x	-	-
306970	Printed Kersey 17 oz. 40" wide (Used on 1012-1003-13-14-15-16)	x	x	x	x	x	-	-	-	-	-
140935	Paperboard (1/2 x 48")	x	x	x	x	x	x	x	-	-	-
135117	Paperboard shim 1/16 x 1 x 36	x	x	x	x	x	x	x	-	-	-
182894	Papercord 1/4 twisted (Used on 1032-23-33-34-35-36-17-37-38-39)	x	x	x	x	x	x	x	x	-	-
211171	Plush high pile worsted (Used on 1032-23-33-34-35-36-37)	x	x	x	x	x	x	-	-	-	-
224304	Rubber strip--door weatherstrip	x	x	x	x	x	x	x	-	-	-
228320	Rubber riser 1/2 half round	x	x	x	x	x	x	-	x	x	x
113983	Silk curtain 22" wide (Used on 1032-23-33-34-35-36-37-38)	x	x	x	x	x	x	x	-	-	-
175757	Snap fastener eyelet--top envelope	-	-	-	-	-	-	-	x	-	-
139150	Snap fastener socket (Carr 548-C) assembly (Mohair) carpet front floor (Used on 1012-1003-13-14-15-16-17-18-19-39)	x	x	x	x	x	x	x	x	-	-
115799	Snap fastener socket--carpet front floor (Used on 1012-1003-13-14-15-16-17-18-19-39)	x	x	x	x	x	x	x	x	-	-
115799	Snap fastener socket--carpet trunk compartment floor (Used on 1032-23-33-34-35)	x	x	x	x	-	-	-	-	-	-
137510	Snap fastener socket--cowl panel tab	x	x	x	x	x	x	x	-	-	-
115798	Snap fastener socket ring (short prong) carpet trunk compartment floor (Used on 1032-23-33-34-35)	x	x	x	x	-	-	-	-	-	-
200073	Snap fastener socket rumble seat compartment floor carpet	-	-	-	-	-	-	x	x	-	-

Piece No.	(15th Series) Name	No. Required									
		1012-32 5 P. Formal Sedan	1003-13-23-33 5 P. Tour. Sedan	1014-34 7 P. Tour. Sedan	1015-35 7 P. Tour. Sedan Lim	1016-36 5 P. Club Sedan	1017-37 5 P. Coupe	1018-38 2-4 P. Coupe	1019-39 2-4 P. Conv. Coupe	1063-73 5 P. Conv. Sedan	1007-27 5 P. Victoria
115798	Snap fastener socket ring (short prong) carpet front floor (Used on 1012-1003-13-14-15-16-17-18-19-39)	x	x	x	x	x	x	x	x	-	-
139150	Snap fastener socket--top envelope	-	-	-	-	-	-	-	x	-	-
214974	Snap fastener socket--top side quarter	-	-	-	-	-	-	-	x	-	-
175757	Snap fastener stud--eyelet type assembly (Mohair) carpet front floor (Used on 1012-1003-13-14-15-16-17-18-19-39)	x	x	x	x	x	x	x	x	-	-
112058	Snap fastener stud (wood screw) (Used on 1032-23-33-34-35-36-37)	x	x	x	x	x	x	-	-	-	-
193201	Snap fastener stud (drive screw) carpet front floor	x	x	x	x	x	x	x	x	-	-
193201	Snap fastener stud (drive screw) carpet trunk compartment floor (Used on 1032-23-33-34-35)	x	x	x	x	-	-	-	-	-	-
185412	Snap fastener wood screw stud--top envelope.	-	-	-	-	-	-	-	x	-	-
206744	Snap fastener stud (drive screw) rumble seat compartment floor	-	-	-	-	-	-	x	x	-	-
139157	Snap fastener stud--top side quarter	-	-	-	-	-	-	-	x	-	-
206744	Snap fastener stud (drive screw) carpet (Mohair) floor rear (Use on bodies 1014-1015-1003-12-13-16-17)	x	x	x	x	x	x	-	-	-	-
175757	Snap fastener eyelet carpet (Mohair) floor rear (Use on bodies 1014-1015-1003-12-13-16-17)	x	x	x	x	x	x	-	-	-	-
139150	Snap fastener socket carpet (Mohair) floor rear (Use on bodies 1014-1015-1003-12-13-16-17)	x	x	x	x	x	x	-	-	-	-
159060	Snap fastener stud (self tapping screw) carpet rear floor (Mohair) (Used on 1003-12-13-14-15-16-17)	x	x	x	x	x	x	-	-	-	-
193200	Snap fastener stud (machine screw) carpet front floor	x	x	x	x	x	x	x	x	-	-
228144	Snap fastener stud (machine screw post) top.	-	-	-	-	-	-	-	x	-	-
193199	Snap fastener stud (rivet) carpet front floor	x	x	x	x	x	x	x	x	-	-
206657	Tacks--upholsters (Specify set number)	x	x	x	x	-	x	-	-	-	-
206656	Tacks--upholsters (Specify set number)	x	x	x	x	-	x	-	-	-	-
29637	Thread No. EE Spool silk	x	x	x	x	x	x	x	x	-	-
192345	Thread No. 18 linen	x	x	x	x	x	x	x	x	-	-
192346	Thread No. 25 linen	x	x	x	x	x	x	x	x	-	-
29638	Thread "A" spool silk	x	x	x	x	x	x	x	x	-	-
29640	Thread No. EE--No. 18 or Dean and Sheck No. 12-4	x	x	x	x	x	x	x	x	-	-
127808	Thread--Dean and Sheck No. 20-A silk finish.	x	x	x	x	x	x	x	x	-	-
200638	Thread No. 80-3 hard finish cotton (Used on 1032-23-33-34-35-36-37-38)	x	x	x	x	x	x	x	-	-	-
200639	Thread No. 90-3 hard finish cotton (Used on 1032-23-33-34-35-36-37-38)	x	x	x	x	x	x	x	-	-	-
157022	Thread--Lincoln No. 6	x	x	x	x	x	x	x	x	-	-
157586	Thread No. 1201 cord	x	x	x	x	x	x	x	x	-	-
29625	Twine No. 252 Yazoo	x	x	x	x	x	x	x	x	-	-
29627	Wadding 32" blue sheet No. 532	x	x	x	x	x	x	x	x	-	-
228446	Wadding white cotton rolled 4"--5 oz. (Used on 1012-1003-13-14-15-16-17-18-38-19-39) .	x	x	x	x	x	x	x	x	-	-

Piece No.	Name	(15th Series)										No. Required	
		1012-32 5 P. Formal Sedan	1003-13-23-33 5 P. Tour. Sedan	1014-34 7 P. Tour. Sedan	1015-35 7 P. Tour. Sedan Lim.	1016-36 5 P. Club Sedan	1017-37 5 P. Coupe	1018-38 2-4 P. Coupe	1019-39 2-4 P. Conv. Coupe	1063-73 5 P. Conv. Sedan	1007-27 5 P. Victoria		
182687	Wadding 32" white unbleached No. 532 (Used on 1012-1003-13-14-15-16-17-18-19)	x	x	x	x	x	x	x	x	x	x	-	-
214213	Wadding 8" white cotton rolled (Used on 1012-1003-13-14-15-16-17-18-19)	x	x	x	x	x	x	x	x	x	x	-	-
172470	Wadding 4" white cotton unbleached roller ..	x	x	x	x	x	x	x	x	x	x	-	-
214211	Wadding 5-1/2" white cotton rolled (Used on 1014-15)	-	-	x	x	-	-	-	-	-	-	-	-
214212	Wadding 8" white cotton rolled (Used on 1014-15)	-	-	x	x	-	-	-	-	-	-	-	-
128040	Wadding 32" white sheet (Used on 1012-32-23-33-34-35-36-37-38-39)	x	x	x	x	x	x	x	x	x	x	-	-
183741	Wadding roof 41" wide	x	x	x	x	x	x	x	x	x	x	-	-
193352	Webbing--elastic (1-1/2" wide)	-	-	-	-	-	-	-	-	x	x	-	-
233472	Webbing--elastic (1/2" wide) (Black)	-	x	x	-	x	-	-	-	-	-	-	-
62759	Webbing jute (3" wide)	-	-	x	x	-	-	-	-	x	-	-	-
214562	Windlace cloth (Pattern Vogt No. 935) (Specify set number) (Used on 1012-1003-13-14-15-16-17-18)	x	x	x	x	x	x	x	x	-	-	-	-
233355	Windlace cloth (Pattern Vogt No. 936) (Specify set number) (Used on 1032-23-33-34-35-36-37-38)	x	x	x	x	x	x	x	x	-	-	-	-
228407	Windlace leather (Natural grain)	-	-	-	-	-	-	-	-	x	-	-	-
226161	Wire No. 13 W & M Ga. (.0915)	-	x	x	x	-	x	-	-	-	-	-	-
233299	Wire No. 9 (.148)	-	x	x	-	x	-	-	-	-	-	-	-
226168	Wire No. 30 Music wire (Used on 1032-23-33-4-5-6-7-8-9)	x	x	x	x	x	x	x	x	x	-	-	-
229576	Zipper 12" long	-	-	-	-	-	-	-	-	-	2	-	-
227976	Zipper 13" long	-	-	-	-	-	-	-	-	-	-	2	2

Faint, illegible text in the upper section of the page.

Faint, illegible text in the middle section of the page.

Faint, illegible text in the lower-middle section of the page.

Faint, illegible text in the lower section of the page.

Faint, illegible text in the lower section of the page.

Faint, illegible text in the lower section of the page.

Piece No.	Name	(16th Series)									
		1112-1132 5 P. Formal Sedan	1103-13-33 5 P. Tour. Sedan	1114-34 7 P. Tour. Sedan	1115-35 7 P. Tour. Sedan Lim	1116-36 5 P. Club Sedan	1117-37 5 P. Coupe	1118-38 2-4 P. Coupe	1119-39 2-4 P. Conv. Coupe	1143-93 5 P. Conv. Sedan	1107-27 5 P. Victoria
		No. Required									
BODY ATTACHING PARTS											
7886	Body to frame bolt No. 1 (7/16-20 x 1-3/4 hex. hd.)	2	2	2	2	2	2	2	2	2	2
5282	Body to frame bolt No.2 (7/16-20 x 3-1/2 hex. hd.)	2	2	2	2	2	2	2	2	2	2
235359	Body to frame bolt No. 2 (inside) (7/16-20 x 10-1/4 flat hd.)	-	-	-	-	-	-	-	2	2	2
5282	Body to frame bolt No. 3 (7/16-20 x 3-1/2 hex. hd.)	2	2	2	2	2	2	2	2	2	2
7954	Body to frame bolt No. 4 (7/16-20 x 3-1/4 hex. hd.)	-	-	-	-	-	2	2	2	-	2
7834	Body to frame bolt No.4 (7/16-20 x 3-1/8 hex. hd.)	2	2	2	2	2	-	-	-	4	-
7954	Body to frame bolt No. 5 (7/16-20 x 3-1/4 hex. hd.)	4	4	4	4	4	4	4	4	-	4
7834	Body to frame bolt No. 5 (7/16-20 x 3-1/8 hex. hd.)	-	-	-	-	-	-	-	-	4	-
221547	Body to frame bolt No. 6 (7/16-20 x 5-5/8 hex. hd.)	2	2	2	2	2	2	2	2	2	2
7890	Body to frame bolt No. 7 (7/16-20 x 1-1/2 hex. hd.)	2	2	2	2	2	2	2	2	2	2
7890	Body to frame bolt No. 8 (7/16-20 x 1-1/2 hex. hd.)	2	2	2	2	2	2	2	2	2	2
131809	Body to frame bolt washer--large (7/16 spl.)	4	4	4	4	4	4	4	4	-	4
131046	Body to frame bolt washer--small (7/16 spl.)	26	26	26	26	24	24	24	24	28	24
5508	Body to frame bolt lockwasher 7/16	4	4	4	4	6	6	6	6	10	6
5806	Body to frame bolt lockwasher 7/16 (Shakeproof)	12	12	12	12	10	10	10	10	8	10
7007	Body to frame bolt nut 7/16-20	14	14	14	14	14	14	14	16	12	16
182439	Body to frame bolt nut lock	12	12	12	12	12	10	10	12	10	12
235416	Body to frame liner (1/16 thick)	-	-	-	-	-	-	-	x	x	x
185273	Body to frame liner (3/16 thick)	x	x	x	x	x	x	x	-	-	-
231975	Body to frame liner (1/8 thick)	-	-	-	-	-	-	-	x	x	x
185270	Body to frame liner (3/8 thick)	x	x	x	x	x	x	x	-	-	-
185274	Body to frame liner (1/4 thick)	x	x	x	x	x	x	x	-	-	-
226790	Body to frame liner (3/8 thick)	-	-	-	-	2	2	2	-	-	-
235397	Body to frame liner anti-squeak	-	-	-	-	-	-	-	x	x	x
308954	Body to frame liner shim--short (1/16 thick)	-	-	-	-	-	-	-	x	-	x
308953	Body to frame liner shim--short (1/8 thick)	-	-	-	-	-	-	-	4	-	4
235082	Body to frame liner--rear	1	1	1	1	-	-	-	-	-	-
235419	Body to frame liner--rear anti-squeak	-	-	-	-	-	-	-	4	-	4
185274	Body hold down bolt bracket liner (1/4 thick)	x	x	x	x	x	x	x	-	-	-
235416	Body hold down bolt bracket liner (1/16 thick)	-	-	-	-	-	-	-	x	x	x
185273	Body hold down bolt bracket liner (3/16 thick)	x	x	x	x	x	x	x	-	-	-
235397	Body hold down bolt bracket liner anti-squeak	-	-	-	-	-	-	-	x	x	x
ANTI-RUMBLE AND ANTI-SQUEAK											
326246	Anti-rumble (body panel) adhesive compound	x	x	x	x	x	x	x	x	x	x
184876	Anti-squeak compound	x	x	x	x	x	x	x	x	x	x
224775	Anti-squeak felt (1/4 x 2" wide strip)	x	x	x	x	x	-	-	-	-	-

Piece No.	(16th Series) Name	No. Required									
		1112-1132 5 P. Formal Sedan	1103-13-33 5 P. Tour. Sedan	1114-34 7 P. Tour. Sedan	1115-35 7 P. Tour. Sedan Lim	1116-36 5 P. Club Sedan	1117-37 5 P. Coupe	1118-38 2-4 P. Coupe	1119-39 2-4 P. Conv. Coupe	1143-53 5 P. Conv. Sedan	1107-27 5 P. Victoria
181545	Anti-squeak tape 2"	x	x	x	x	x	x	x	x	x	x
187525	Anti-squeak tape 1-1/4"	x	x	x	x	x	x	x	x	x	x
51331	Anti-squeak tape 1-1/2"	x	x	x	x	x	x	x	x	x	x
39403	Anti-squeak tape 3/4"	x	x	x	x	x	x	x	x	x	x
314441	Body sealer--inner body M.M.M.E.C. 108	x	x	x	x	x	x	x	x	x	x

ARM REST

Always send samples of material when ordering trimmed assemblies, as the assemblies are upholstered to match the body interior.

233720	Arm rest (trimmed) assembly--right (Used on 1112-1103-1113)	1	1	-	-	-	-	-	-	-	-
233721	Arm rest (trimmed) assembly--left (Used on 1112-1103-1113)	1	1	-	-	-	-	-	-	-	-
233722	Arm rest (trimmed) assembly--right (Used on 1114)	-	-	1	-	-	-	-	-	-	-
233723	Arm rest (trimmed) assembly--left (Used on 1114)	-	-	1	-	-	-	-	-	-	-
233724	Arm rest (trimmed) assembly--right (Used on 1115)	-	-	-	1	-	-	-	-	-	-
233725	Arm rest (trimmed) assembly--left (Used on 1115)	-	-	-	1	-	-	-	-	-	-
233726	Arm rest (trimmed) assembly--right (Used on 1116)	-	-	-	-	1	-	-	-	-	-
233727	Arm rest (trimmed) assembly--left (Used on 1116)	-	-	-	-	1	-	-	-	-	-
233728	Arm rest (trimmed) assembly--right (Used on 1117)	-	-	-	-	-	1	-	-	-	-
233729	Arm rest (trimmed) assembly--left (Used on 1117)	-	-	-	-	-	1	-	-	-	-
233350	Arm rest (trimmed) assembly--right (Used on 1132)	1	-	-	-	-	-	-	-	-	-
233194	Arm rest (trimmed) assembly--right (Used on 1133)	-	1	-	-	-	-	-	-	-	-
233195	Arm rest (trimmed) assembly--left (Used on 1133)	-	1	-	-	-	-	-	-	-	-
233351	Arm rest (trimmed) assembly--left (Used on 1132)	1	-	-	-	-	-	-	-	-	-
243352	Arm rest (trimmed) assembly--right (Used on 1143)	-	-	-	-	-	-	-	-	1	-
243353	Arm rest (trimmed) assembly--left (Used on 1143)	-	-	-	-	-	-	-	-	1	-
243354	Arm rest (trimmed) assembly--right (Used on 1107)	-	-	-	-	-	-	-	-	-	1
243355	Arm rest (trimmed) assembly--left (Used on 1107)	-	-	-	-	-	-	-	-	-	1
244008	Arm rest (trimmed) assembly--right (Used on 1127)	-	-	-	-	-	-	-	-	-	1
244009	Arm rest (trimmed) assembly--left (Used on 1127)	-	-	-	-	-	-	-	-	-	1
244006	Arm rest (trimmed) assembly--right (Used on 1153)	-	-	-	-	-	-	-	-	1	-

Piece No.	Name	(16th Series)										
		1112-1132 5 P. Formal Sedan	1103-1133 5 P. Tour. Sedan	1114-34 7 P. Tour. Sedan	1115-35 7 P. Tour. Sedan Lim.	1116-36 5 P. Club Sedan	1117-37 5 P. Coupe	1118-38 2-4 P. Coupe	1119-39 2-4 P. Conv. Coupe	1143-53 5 P. Conv. Sedan	1107-27 5 P. Victoria	
		No. Required										
244007	Arm rest (trimmed) assembly--left (Used on 1153)	-	-	-	-	-	-	-	-	-	1	-
233196	Arm rest (trimmed) assembly--right (Used on 1134)	-	-	1	-	-	-	-	-	-	-	-
233197	Arm rest (trimmed) assembly--left (Used on 1134)	-	-	1	-	-	-	-	-	-	-	-
233198	Arm rest (trimmed) assembly--right (Used on 1135)	-	-	-	1	-	-	-	-	-	-	-
233199	Arm rest (trimmed) assembly--left (Used on 1135)	-	-	-	1	-	-	-	-	-	-	-
233200	Arm rest (trimmed) assembly--right (Used on 1136)	-	-	-	-	1	-	-	-	-	-	-
233201	Arm rest (trimmed) assembly--left (Used on 1136)	-	-	-	-	1	-	-	-	-	-	-
233202	Arm rest (trimmed) assembly--right (Used on 1137)	-	-	-	-	-	1	-	-	-	-	-
233203	Arm rest (trimmed) assembly--left (Used on 1137)	-	-	-	-	-	1	-	-	-	-	-
231806	Arm rest ash tray trim block-cover plate (Used on 1133-34-35-37)	-	2	2	2	-	2	-	-	-	-	-
6230	Arm rest attaching screw 1/4-28 x 11/16 flat hd.	2	2	2	2	4	-	-	-	-	-	-
193730	Arm rest attaching screw ferrule 1/4	2	2	2	2	4	-	-	-	-	-	-
224142	Arm rest attaching key hole plate--right (Used on 1103-12-13-14-15-16-17-32-36-37)	1	1	1	1	1	1	-	-	-	-	-
224320	Arm rest plate--right (Used on 1112-32-1103-1113)	1	1	-	-	-	-	-	-	-	-	-
224319	Arm rest plate--left (Used on 1112-32-1103-1113)	1	1	-	-	-	-	-	-	-	-	-
224143	Arm rest attaching key hole plate--left (Used on 1103-12-13-14-15-16-17-32-36-37)	1	1	1	1	1	1	-	-	-	-	-
224914	Arm rest cushion--right (Used on 1117)	-	-	-	-	-	1	-	-	-	-	-
231890	Arm rest cushion--right (Used on 1137)	-	-	-	-	-	1	-	-	-	-	-
235186	Arm rest cushion--right (Used on 1112-32-1103-1113)	1	1	-	-	-	-	-	-	-	-	-
231800	Arm rest cushion--right (Used on 1133)	-	1	-	-	-	-	-	-	-	-	-
224951	Arm rest cushion--left (Used on 1116)	-	-	-	-	1	-	-	-	-	-	-
224952	Arm rest cushion--left (Used on 1136)	-	-	-	-	1	-	-	-	-	-	-
224998	Arm rest cushion--left (Used on 1117)	-	-	-	-	-	1	-	-	-	-	-
231891	Arm rest cushion--left (Used on 1137)	-	-	-	-	-	1	-	-	-	-	-
235187	Arm rest cushion--left (Used on 1112-32-1103-1113)	1	1	-	-	-	-	-	-	-	-	-
231801	Arm rest cushion--left (Used on 1133)	-	1	-	-	-	-	-	-	-	-	-
224188	Arm rest cushion--right (Used on 1114-15)	-	-	1	1	-	-	-	-	-	-	-
231804	Arm rest cushion--right (Used on 1134-35)	-	-	1	1	-	-	-	-	-	-	-
224860	Arm rest cushion--right (Used on 1116)	-	-	-	-	1	-	-	-	-	-	-
226387	Arm rest cushion--right (Used on 1136)	-	-	-	-	1	-	-	-	-	-	-
224876	Arm rest cushion--left (Used on 1114-15)	-	-	1	1	-	-	-	-	-	-	-
231805	Arm rest cushion--left (Used on 1134-35)	-	-	1	1	-	-	-	-	-	-	-
243584	Arm rest cushion--right	-	-	-	-	-	-	-	-	-	1	-
243585	Arm rest cushion--left	-	-	-	-	-	-	-	-	-	1	-
243608	Arm rest cushion--right	-	-	-	-	-	-	-	-	-	-	1
243609	Arm rest cushion--left	-	-	-	-	-	-	-	-	-	-	1

Piece No.	Name (16th Series)											No. Required
		1112-1132 S P. Formal Sedan	1103-13-33 S P. Tour. Sedan	1114-34 7 P. Tour. Sedan	1115-35 7 P. Tour. Sedan Lum	1116-36 S P. Club Sedan	1117-37 S P. Coupe	1118-38 2-4 P. Coupe	1119-39 2-4 P. Conv. Coupe	1143-53 S P. Conv. Sedan	1107-27 S P. Victoria	
ASH TRAY												
226032	Ash tray assembly (Walnut) (Used on 1116) ..	-	-	-	-	1	-	-	-	-	-	-
241306	Ash tray assembly (Antiqua Tan) (Used on 1116)	-	-	-	-	1	-	-	-	-	-	-
231814	Ash tray assembly--right (Used on 1136)	-	-	-	-	1	-	-	-	-	-	-
231815	Ash tray assembly--left (Used on 1136)	-	-	-	-	1	-	-	-	-	-	-
241124	Ash tray assembly (Used on 1133-34-35-37-1107-27-1143-53)	-	2	2	2	-	2	-	-	2	2	-
105029	Ash tray assembly spring dowel (1 required for 1116, 2 required for 1136)	-	-	-	-	-	-	-	-	-	-	-
235750	Ash tray (instrument board)	1	1	1	1	1	1	1	1	1	1	1
187144	Ash tray ash receiver (1 required for 1112-1103-1113-14-15-17-2 required for 1132) ..	-	-	-	-	-	-	-	-	-	-	-
214620	Ash tray ash receiver (1 required for 1116, 2 required for 1136)	-	-	-	-	-	-	-	-	-	-	-
241129	Ash tray cigar lighter (complete) (Used on 1112-1103-13-17)	1	1	-	-	-	1	-	-	-	-	-
241131	Ash tray cigar lighter (complete) (2 required for 1132-36, 1 required for 1114-15-16)	-	-	-	-	-	-	-	-	-	-	-
241130	Ash tray cigar lighter (complete) (Used on 1133-34-35)	-	2	2	2	-	-	-	-	-	-	-
241126	Ash tray cigar lighter (complete) (Used on 1137)	-	-	-	-	-	2	-	-	-	-	-
241299	Ash tray cigar lighter base	-	-	-	-	-	-	-	-	1	1	-
241128	Ash tray cigar lighter (knob and tip) (1 required for 1112-1103-13-14-15-16-17-43-53-1107-1127, 2 required for 1132-33-34-35-36-37)	-	-	-	-	-	-	-	-	-	-	-
327622	Ash tray cigar lighter resistor (With 12 volt equipment)	1	1	1	1	1	1	-	-	1	-	-
327320	Ash tray cigar lighter resistor cable assembly (With 12 volt equipment)	1	1	1	1	1	1	-	-	1	-	-
33287	Terminal (With 12 volt equipment)	2	2	2	2	2	2	-	-	2	-	-
36111	Terminal insulator (With 12 volt equip.)	2	2	2	2	2	2	-	-	2	-	-
0239616	Ash tray cigar lighter tip (1 required for 1112-1103-13-14-15-16-17-1107-27-1143-53, 2 required for 1132-33-34-35-36-37)	-	-	-	-	-	-	-	-	-	-	-
235884	Ash tray cover plate (Used on 1112-1103-13-17) (Antiqua Tan)	1	1	-	-	-	1	-	-	-	-	-
224504	Ash tray cover plate (Used on 1103-12-13-17) (Walnut)	1	1	-	-	-	-	-	-	-	-	-
235885	Ash tray cover plate, (Used on 1114-15) (Antiqua Tan)	-	-	1	1	-	-	-	-	-	-	-
224675	Ash tray cover plate (Used on 1114-15) (Walnut)	-	-	1	1	-	1	-	-	-	-	-
235102	Ash tray cover plate--right (Used on 1132) ..	1	-	-	-	-	-	-	-	-	-	-
224519	Ash tray cover plate--left (Used on 1132) ..	1	-	-	-	-	-	-	-	-	-	-

DASH

235605	Dash panel assembly (L.H. drive)	1	1	1	1	1	1	1	1	1	1	1
241088	Dash panel assembly (R.H. drive)	1	1	1	1	1	1	1	1	1	1	1
199045	Clinch nut 1/4-28 thread	15	15	15	15	15	15	15	15	15	15	15



15th Series
Only



327622



0239616



241126-29-30-31



241128



241124



214620

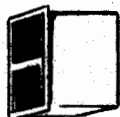

187144

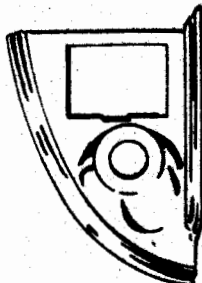

235884

235102

224519

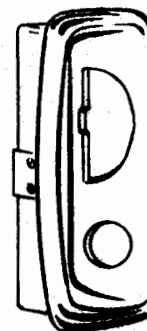

226032- 241306

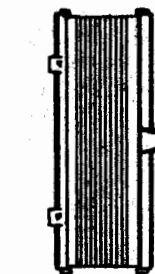

235750

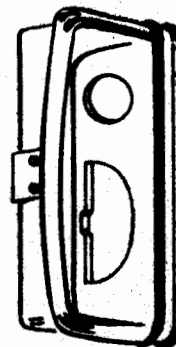

231814-231815

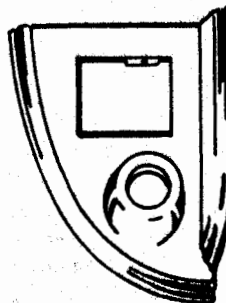

235885

Piece No.	Name	(16th Series)									
		1112-1132 S P. Formal Sedan	1103-13-33 S P. Tour. Sedan	1114-34 7 P. Tour. Sedan	1115-35 7 P. Tour. Sedan Lim	1116-36 S P. Club Sedan	1117-37 S P. Coupe	1118-38 2-4 P. Coupe	1119-39 2-4 P. Conv. Coupe	1143-53 S P. Conv. Sedan	1107-27 S P. Victoria
		No. Required									
224072	Clinch nut 5/16-24 thread	1	1	1	1	1	1	1	-	-	-
235792	Dash panel bonnet dash liner--side	2	2	2	2	2	2	2	2	2	2
235791	Dash panel bonnet dash liner--top	2	2	2	2	2	2	2	2	2	2
228260	Dash panel bonnet dash liner hook	4	4	4	4	4	4	4	4	4	4
229340	Washer 3/16 (special)	4	4	4	4	4	4	4	4	4	4
7002	Nut No. 8-32 thread	4	4	4	4	4	4	4	4	4	4
228251	Dash panel bonnet dash liner hook saddle ...	4	4	4	4	4	4	4	4	4	4
187803	Dash panel bonnet dash liner staple 3/4" long	6	6	6	6	6	6	6	6	6	6
228284	Dash panel bonnet dash liner staple weatherstrip	x	x	x	x	x	x	x	x	x	x
228246	Dash panel bonnet dash liner staple saddle .	6	6	6	6	6	6	6	6	6	6
235754	Dash panel inter-liner (L.H. drive)	1	1	1	1	1	1	1	1	1	1
235878	Dash panel inter-liner (R.H. drive)	1	1	1	1	1	1	1	1	1	1
235756	Dash panel liner assembly (L.H. drive)	1	1	1	1	1	1	1	1	1	1
235870	Dash panel liner assembly (R.H. drive)	1	1	1	1	1	1	1	1	1	1
111074	Dash panel liner snap fastener stud (eyelet type)	7	7	7	7	7	7	7	7	7	7
123094	Dash panel liner snap fastener stud (eyelet)	7	7	7	7	7	7	7	7	7	7
5317	Dash panel liner screw 1/4-28 x 1-1/8 hex. hex. hd.	2	2	2	2	2	2	2	2	2	2
5502	Lockwasher 1/4	2	2	2	2	2	2	2	2	2	2
62065	Washer 1/4 plain	1	1	1	1	1	1	1	1	1	1
220976	Dash panel to sill screw 5/16-24 x 4-1/4 hex. hd.	2	2	2	2	2	2	2	2	2	2
6070	Lockwasher 5/16 (Shakeproof) (Wood type)	2	2	2	2	2	2	2	2	2	2
325790	Dash panel hole plug 3/4" dia. (Used on all cars not equipped with heater)	x	x	x	x	x	x	x	x	x	x
325789	Dash panel hole plug 7/16" dia. (Used on cars not equipped with radio and heaters).	x	x	x	x	x	x	x	x	x	x

DOOR

All doors must be adjusted to each respective body. To obtain satisfactory replacement of doors, it is advisable to return the damaged door to be repaired, if possible. If this cannot be done, the customer assumes the responsibility of the new door being a satisfactory fit. Specify on all orders the upholstery material, color and striping.

0243284	Door front right trimmed assy. (Used on 1103-1116)	-	1	-	-	1	-	-	-	-	-
0243304	Door front right trimmed assy. (Used on 1136)	-	-	-	-	1	-	-	-	-	-
0243286	Door front right trimmed assy. (Used on 1112-13-14)	1	1	1	-	-	-	-	-	-	-
0243288	Door front right trimmed assy. (Used on 1132-33-34)	1	1	1	-	-	-	-	-	-	-
0243302	Door front right trimmed assy. (Used on 1115)	-	-	-	1	-	-	-	-	-	-
0243342	Door front right trimmed assy. (Used on 1135)	-	-	-	1	-	-	-	-	-	-
0243290	Door front right trimmed assy. (Used on 1117)	-	-	-	-	-	1	-	-	-	-
0243292	Door front right trimmed assy. (Used on 1137)	-	-	-	-	-	1	-	-	-	-
0243294	Door front right trimmed assy. (Used on 1118)	-	-	-	-	-	-	1	-	-	-
0243296	Door front right trimmed assy. (Used on 1138)	-	-	-	-	-	-	1	-	-	-

(16th Series)

Piece No.

Name

1112-1132
5 P. Formal Sedan
1103-13-33
5 P. Tour. Sedan
1114-24
7 P. Tour. Sedan
1115-35
7 P. Tour. Sedan Lim.
1116-36
5 P. Club Sedan
1117-37
5 P. Coupe
1118-38
2-4 P. Coupe
1119-39
2-4 P. Conv. Coupe
1143-53
5 P. Conv. Sedan
1107-27
5 P. Victoria

No. Required

0243298	Door front right trimmed assy. (Used on 1119)	-	-	-	-	-	-	-	-	1	-	-
0243300	Door front right trimmed assy. (Used on 1139)	-	-	-	-	-	-	-	-	1	-	-
0243280	Door front right trimmed assy. (Used on 1127)	-	-	-	-	-	-	-	-	-	-	1
0243282	Door front right trimmed assy. (Used on 1107)	-	-	-	-	-	-	-	-	-	-	1
0243306	Door front right trimmed assy. (Used on 1143)	-	-	-	-	-	-	-	-	-	1	-
0243308	Door front right trimmed assy. (Used on 1153)	-	-	-	-	-	-	-	-	-	1	-
0243281	Door front left trimmed assy. (Used on 1127)	-	-	-	-	-	-	-	-	-	-	1
0243283	Door front left trimmed assy. (Used on 1107)	-	-	-	-	-	-	-	-	-	-	1
0243307	Door front left trimmed assy. (Used on 1143)	-	-	-	-	-	-	-	-	-	1	-
0243309	Door front left trimmed assy. (Used on 1153)	-	-	-	-	-	-	-	-	-	1	-
0243285	Door front left trimmed assy. (Used on 1103-1116)	-	1	-	-	-	-	-	-	-	-	-
0243305	Door front left trimmed assy. (Used on 1136)	-	-	-	-	-	-	1	-	-	-	-
0243287	Door front left trimmed assy. (Used on 1112-13-14)	1	1	1	-	-	-	-	-	-	-	-
0243289	Door front left trimmed assy. (Used on 1132-33-34)	1	1	1	-	-	-	-	-	-	-	-
0243303	Door front left trimmed assy. (Used on 1115)	-	-	-	1	-	-	-	-	-	-	-
0243343	Door front left trimmed assy. (Used on 1135)	-	-	-	1	-	-	-	-	-	-	-
0243291	Door front left trimmed assy. (Used on 1117)	-	-	-	-	-	-	1	-	-	-	-
0243293	Door front left trimmed assy. (Used on 1137)	-	-	-	-	-	-	1	-	-	-	-
0243295	Door front left trimmed assy. (Used on 1118)	-	-	-	-	-	-	-	1	-	-	-
0243297	Door front left trimmed assy. (Used on 1138)	-	-	-	-	-	-	-	1	-	-	-
0243299	Door front left trimmed assy. (Used on 1119)	-	-	-	-	-	-	-	-	1	-	-
0243301	Door front left trimmed assy. (Used on 1139)	-	-	-	-	-	-	-	-	1	-	-
0243313	Door rear left trimmed assy. (Used on 1112)	1	-	-	-	-	-	-	-	-	-	-
0243315	Door rear left trimmed assy. (Used on 1132)	1	-	-	-	-	-	-	-	-	-	-
0243311	Door rear left trimmed assy. (Used on 1103)	-	1	-	-	-	-	-	-	-	-	-
0243317	Door rear left trimmed assy. (Used on 1113)	-	1	-	-	-	-	-	-	-	-	-
0243319	Door rear left trimmed assy. (Used on 1133)	-	1	-	-	-	-	-	-	-	-	-
0243321	Door rear left trimmed assy. (Used on 1114-15)	-	-	1	1	-	-	-	-	-	-	-
0243323	Door rear left trimmed assy. (Used on 1134-35)	-	-	1	1	-	-	-	-	-	-	-
0243329	Door rear left trimmed assy. (Used on 1116)	-	-	-	-	-	-	1	-	-	-	-
0243331	Door rear left trimmed assy. (Used on 1136)	-	-	-	-	-	-	1	-	-	-	-
0243325	Door rear left trimmed assy. (Used on 1143)	-	-	-	-	-	-	-	-	-	1	-
0243327	Door rear left trimmed assy. (Used on 1153)	-	-	-	-	-	-	-	-	-	1	-
0243324	Door rear right trimmed assy. (Used on 1143)	-	-	-	-	-	-	-	-	-	1	-
0243326	Door rear right trimmed assy. (Used on 1153)	-	-	-	-	-	-	-	-	-	1	-
0243312	Door rear right trimmed assy. (Used on 1112)	1	-	-	-	-	-	-	-	-	-	-
0243314	Door rear right trimmed assy. (Used on 1132)	1	-	-	-	-	-	-	-	-	-	-
0243310	Door rear right trimmed assy. (Used on 1103)	-	1	-	-	-	-	-	-	-	-	-
0243316	Door rear right trimmed assy. (Used on 1113)	-	1	-	-	-	-	-	-	-	-	-
0243318	Door rear right trimmed assy. (Used on 1133)	-	1	-	-	-	-	-	-	-	-	-
0243320	Door rear right trimmed assy. (Used on 1114-15)	-	-	1	1	-	-	-	-	-	-	-
0243322	Door rear right trimmed assy. (Used on 1134-35)	-	-	1	1	-	-	-	-	-	-	-
0243328	Door rear right trimmed assy. (Used on 1116)	-	-	-	-	-	-	1	-	-	-	-
0243330	Door rear right trimmed assy. (Used on 1136)	-	-	-	-	-	-	1	-	-	-	-

(16th Series)

Piece No.

Name

1112-1132 5 P. Formal Sedan
 1103-13-33 5 P. Tour. Sedan
 1114-34 7 P. Tour. Sedan
 1115-35 7 P. Tour. Sedan Lim
 1116-36 5 P. Club Sedan
 1117-37 5 P. Coupe
 1118-38 2-4 P. Coupe
 1119-39 2-4 P. Conv. Coupe
 1143-93 5 P. Conv. Sedan
 1107-27 5 P. Victoria

No. Required

DOOR ARM REST

Always send samples of material when ordering trimmed assemblies, as the assemblies are upholstered to match the body interior.

233384	Door arm rest (trimmed) assembly--right	1	1	1	-	1	1	1	-	-	-
233385	Door arm rest (trimmed) assembly--left	1	1	1	-	1	1	1	-	-	-
233382	Door arm rest (trimmed) assembly--right	-	-	-	1	-	-	-	1	1	1
233383	Door arm rest (trimmed) assembly--left	-	-	-	1	-	-	-	1	1	1
231970	Door arm rest cushion--right	1	1	1	1	1	1	1	1	1	1
231971	Door arm rest cushion--left	1	1	1	1	1	1	1	1	1	1
231972	Door arm rest support--right	1	1	1	1	1	1	1	1	1	1
231973	Door arm rest support--left	1	1	1	1	1	1	1	1	1	1
231976	Door arm rest support trim stick	2	2	2	2	2	2	2	2	2	2

DOOR PARTS

308103	Front door anti-rattler--upper 1/4"	2	2	2	2	2	2	2	-	-	-
308102	Front door anti-rattler--upper 3/16"	2	2	2	2	2	2	2	-	-	-
199167	Front door anti-rattler--lower	2	2	2	2	2	2	2	2	2	2
218305	Front door anti-rattler shim	x	x	x	x	x	x	x	x	x	x
185602	Front door bumper (1-9/32)	x	x	x	x	x	x	x	x	x	x
185601	Front door bumper (1-11/32)	x	x	x	x	x	x	x	x	x	x
185600	Front door bumper (1-13/32)	x	x	x	x	x	x	x	x	x	x
218685	Front door bumper (1-15/32)	x	x	x	x	x	x	x	x	x	x
236688	Front door diagonal brace	-	-	-	-	-	-	-	2	-	2
236732	Front door diagonal brace--right	-	-	-	-	-	-	-	-	1	-
236733	Front door diagonal brace--left	-	-	-	-	-	-	-	-	1	-
235046	Front door dovetail--male	2	2	2	2	2	2	2	4	4	4
6727	Front door dovetail--male screw 1/4-28 x 1-1/2 flat hd.	-	-	-	-	-	-	-	-	8	8
235042	Front door dovetail--female (single)	2	2	2	2	2	2	2	-	-	-
235559	Front door dovetail--female (double)	-	-	-	-	-	-	-	2	2	2
6836	Screw 1/4-20 x 1" oval hd.	-	-	-	-	-	-	-	-	6	-
229986	Front door hinge lower--right	1	1	1	1	1	1	1	-	-	-
230578	Front door hinge lower--right	-	-	-	-	-	-	-	1	1	1
229987	Front door hinge lower--left	1	1	1	1	1	1	1	-	-	-
230579	Front door hinge lower--left	-	-	-	-	-	-	-	1	1	1
6672	Screw 1/4-28 x 4-1/8 oval hd.	4	4	4	4	4	4	4	-	-	-
236062	Screw 5/16-24 x 5 flat hd. special	-	-	-	-	-	-	-	4	4	4
6449	Screw 1/4-28 x 2-3/8 flat hd.	4	4	4	4	4	4	4	-	-	-
236060	Screw 5/16-24 x 2 flat hd. special	-	-	-	-	-	-	-	2	2	2
236061	Screw 5/16-24 x 2-1/2 flat hd. special.	-	-	-	-	-	-	-	2	2	2
5899	Lockwasher 5/16 countersunk (Shakeproof)	-	-	-	-	-	-	-	16	16	16
184692	Screw boss 1/4-28 (Floating nut type) .	4	4	4	4	4	4	4	-	-	-
229988	Front door hinge upper right assembly	1	1	1	1	1	1	1	1	1	1
229989	Front door hinge upper left assembly	1	1	1	1	1	1	1	1	1	1
6449	Screw 1/4-28 x 2-3/8 flat hd.	8	8	8	8	8	8	8	6	6	6
5747	Screw 1/4-28 x 1-5/8 flat hd.	-	-	-	-	-	-	-	2	2	2
5899	Lockwasher 5/16 countersunk (Shakeproof)	8	8	8	8	8	8	8	8	8	8
7819	Screw 3/8-24 x 1 hex. hd.	6	6	6	6	6	6	6	6	6	6
5506	Lockwasher 3/8	6	6	6	6	6	6	6	6	6	6
310588	Front door hinge upper assembly stop bumper.	2	2	2	2	2	2	2	2	2	2
4927	Screw No. 8 x 7/8 rnd. hd.	2	2	2	2	2	2	2	2	2	2

Piece No.	Name	(16th Series)									
		1112-1132 5 P. Formal Sedan	1103-13-33 5 P. Tour. Sedan	1114-34 7 P. Tour. Sedan	1115-35 7 P. Tour. Sedan Lim.	1116-36 5 P. Club Sedan	1117-37 5 P. Coupe	1118-38 2-4 P. Coupe	1119-39 2-4 P. Conv. Coupe	1143-53 5 P. Conv. Sedan	1107-27 5 P. Victoria
		No. Required									
235141	Front door hinge upper bracket liner	2	2	2	2	2	2	2	2	2	2
310576	Front door hinge upper pin	2	2	2	2	2	2	2	2	2	2
235956	Front door hinge upper pin bushing	4	4	4	4	4	4	4	4	4	4
231820	Front door hinge lower pin	2	2	2	2	2	2	2	2	2	2
230588	Front door hinge lower pin	-	-	-	-	-	-	-	-	-	-
231821	Front door hinge lower pin screw	2	2	2	2	2	2	2	2	2	2
5500	Lockwasher No. 10	2	2	2	2	2	2	2	2	2	2
183171	Front door lock--left	1	1	1	1	1	1	1	1	1	1
183170	Front door lock--right	1	1	1	1	1	1	1	1	1	1
5829	Screw No. 10-32 x 7/8 flat hd.	4	4	4	4	4	4	4	-	-	-
8207	Screw No. 10-32 x 3/4 flat hd.	-	-	-	-	-	-	-	2	2	2
8224	Screw No. 10-32 x 5/8 flat hd.	-	-	-	-	-	-	-	4	4	4
5491	Lockwasher 3/16 countersunk (Shakeproof)	4	4	4	4	4	4	4	6	6	6
8022	Screw No. 10-32 x 3/8 oval hd.	-	-	-	-	-	-	-	4	4	4
235100	Front door lock board attaching plate	4	4	4	4	4	4	4	-	-	-
6698	Front door lock board attaching screw No. 12-24 x 7/8 flat hd.	-	-	-	-	-	-	-	6	6	6
235255	Front door lock board attaching screw countersunk washer 1/4 special	-	-	-	-	-	-	-	14	14	14
235800	Front door lock handle--right (with key lock)	1	1	1	1	1	1	1	-	-	-
235802	Front door lock handle--left	1	1	1	1	1	1	1	-	-	-
236942	Front door lock handle--right (with key lock)	-	-	-	-	-	-	-	1	-	1
236946	Front door lock handle--right (with key lock)	-	-	-	-	-	-	-	-	1	-
236944	Front door lock handle--left	-	-	-	-	-	-	-	-	1	-
236940	Front door lock handle--left	-	-	-	-	-	-	-	-	1	-
326030	Front door lock handle cylinder lock	1	1	1	1	1	1	1	1	1	1
6775	Front door lock handle screw No. 12-24 x 7/16 (Phillips) rnd. hd.	2	2	2	2	2	2	2	2	2	2
6719	Front door lock handle screw lockwasher No. 12 (Shakeproof)	2	2	2	2	2	2	2	2	2	2
327342	Front door lock handle gasket	2	2	2	2	2	2	2	2	2	2
227518	Front door lock pillar finishing plate--rt..	-	-	-	-	-	-	-	1	-	1
227519	Front door lock pillar finishing plate--lt..	-	-	-	-	-	-	-	1	-	1
236728	Front door lock pillar finishing plate--rt..	-	-	-	-	-	-	-	-	1	-
236729	Front door lock pillar finishing plate--lt..	-	-	-	-	-	-	-	-	1	-
6536	Screw No. 4-40 x 5/16 flat hd.	-	-	-	-	-	-	-	4	6	4
231554	Front door lock remote control--right (Used on 1103-16-36)	-	1	-	-	1	-	-	-	-	-
236716	Front door lock remote control--right	-	-	-	-	-	-	-	1	-	1
236040	Front door lock remote control--right	-	-	-	-	-	-	-	-	1	-
231555	Front door lock remote control--left (Used on 1103-16-36)	-	1	-	-	1	-	-	-	-	-
236717	Front door lock remote control--left	-	-	-	-	-	-	-	1	-	1
236041	Front door lock remote control--left	-	-	-	-	-	-	-	-	1	-
231556	Front door lock remote control--right (Not used on 1103)	1	1	1	1	-	1	1	-	-	-
231557	Front door lock remote control--left (Not used on 1103)	1	1	1	1	-	1	1	-	-	-
8207	Screw No. 10-32 x 3/4 flat hd.	-	-	-	-	-	-	-	4	4	4
241117	Front door lock remote control handle	2	2	2	2	2	2	2	2	2	2
241115	Front door lock remote control handle escutcheon plate	2	2	2	2	2	2	2	2	2	2
133264	Front door lock remote control handle escutcheon plate spring	2	2	2	2	2	2	2	2	2	2
133339	Front door lock remote control handle insert	2	2	2	2	2	2	2	2	2	2

Piece No.	Name	(16th Series)									
		1112-1132 5 P. Formal Sedan	1103-13-33 5 P. Tour. Sedan	1114-34 7 P. Tour. Sedan	1115-35 7 P. Tour. Sedan Lim.	1116-36 5 P. Club Sedan	1117-37 5 P. Coupe	1118-38 2-4 P. Coupe	1119-39 2-4 P. Conv. Coupe	1143-53 5 P. Conv. Sedan	1107-27 5 P. Victoria
		No. Required									
132972	Front door lock remote control handle pin ..	2	2	2	2	2	2	2	2	2	2
229997	Front door lock striker (Used on 1112-1103-13-14-15-16-17-18-19)	2	2	2	2	2	2	2	2	-	-
229996	Front door lock striker (Used on 1132-33-34-35-36-37-38-39-1107-27-43-53)	2	2	2	2	2	2	2	2	2	2
6835	Screw No. 12-24 x 7/8 flat hd.	-	-	-	-	-	-	-	-	4	-
241136	Front door panel--right (Used on 1103-16-36)	-	1	-	-	1	-	-	-	-	-
241137	Front door panel--left (Used on 1103-16-36)	-	1	-	-	1	-	-	-	-	-
241138	Front door panel--right (Used on 1112-13-14-15-32-33-34-35)	1	1	1	1	-	-	-	-	-	-
241139	Front door panel--left (Used on 1112-13-14-15-32-33-34-35)	1	1	1	1	-	-	-	-	-	-
241142	Front door panel--right	-	-	-	-	-	1	-	-	-	-
241144	Front door panel--right	-	-	-	-	-	-	-	-	1	-
241143	Front door panel--left	-	-	-	-	-	1	-	-	-	-
241145	Front door panel--left	-	-	-	-	-	-	-	-	1	-
241146	Front door panel--right	-	-	-	-	-	-	1	-	-	-
241140	Front door panel--right	-	-	-	-	-	-	-	1	-	1
241147	Front door panel--left	-	-	-	-	-	-	1	-	-	-
241141	Front door panel--left	-	-	-	-	-	-	-	1	-	1
235622	Front door truss assembly (Used on 1103-16-36)	-	2	-	-	2	-	-	-	-	-
235029	Front door truss assembly (Not used on 1103)	2	2	2	2	2	2	2	2	-	-
241283	Front door weatherstrip 19" long	2	2	2	2	2	2	2	2	-	-
241284	Front door weatherstrip 98" long	2	2	2	2	2	2	2	2	-	-
314936	Front door weatherstrip clip	x	x	x	x	x	x	x	x	-	-
235958	Front door weatherstrip upper hinge--right ..	1	1	1	1	1	1	1	1	-	-
235959	Front door weatherstrip upper hinge--left ..	1	1	1	1	1	1	1	1	-	-
228239	Front door window to center removable pillar weatherstrip (Black)	-	-	-	-	-	-	-	-	x	-
228238	Front door window to center removable pillar weatherstrip (Tan)	-	-	-	-	-	-	-	-	x	-
227842	Front door window to center removable pillar weatherstrip retainer--right	-	-	-	-	-	-	-	-	1	-
227843	Front door window to center removable pillar weatherstrip retainer--left	-	-	-	-	-	-	-	-	1	-
235934	Front door window finishing moulding assembly--right (Used on 1103-1116) (Antiqua Tan)	-	1	-	-	1	-	-	-	-	-
220729	Front door window finishing moulding assembly--right (Used on 1103-1116) (Walnut)	-	1	-	-	1	-	-	-	-	-
235935	Front door window finishing moulding assembly--left (Used on 1103-1116) (Antiqua Tan)	-	1	-	-	1	-	-	-	-	-
220730	Front door window finishing moulding assembly--left (Used on 1103-1116) (Walnut)	-	1	-	-	1	-	-	-	-	-
235932	Front door window finishing moulding assembly--right (Used on 1112-13-14-15-17) (Antiqua Tan)	1	1	1	1	-	1	-	-	-	-
220712	Front door window finishing moulding assembly--right (Used on 1112-13-14-15-17) (Walnut)	1	1	1	1	-	1	-	-	-	-

Piece No.	Name	(16th Series)									
		1112-1132 S P. Formal Sedan	1109-13-33 S P. Tour Sedan	1114-34 7 P. Tour Sedan	1115-35 7 P. Tour Sedan Lim	1116-36 S P. Club Sedan	1117-37 S P. Coupe	1118-38 2-4 P. Coupe	1119-39 2-4 P. Conv. Coupe	1143-53 S P. Conv Sedan	1107-27 S P. Victoria
		No. Required									
235933	Front door window finishing moulding assembly--left (Used on 1112-13-14-15-17) (Antiqua Tan)	1	1	1	1	-	1	-	-	-	-
220713	Front door window finishing moulding assembly--left (Used on 1112-13-14-15-17) (Walnut)	1	1	1	1	-	1	-	-	-	-
235944	Front door window finishing moulding assembly--right (Used on 1118) (Antiqua Tan)	-	-	-	-	-	-	1	-	-	-
226040	Front door window finishing moulding assembly--right (Used on 1118) (Walnut) ..	-	-	-	-	-	-	1	-	-	-
235945	Front door window finishing moulding assembly--left (Used on 1118) (Antiqua Tan)	-	-	-	-	-	-	1	-	-	-
226041	Front door window finishing moulding assembly--left (Used on 1118) (Walnut) ...	-	-	-	-	-	-	1	-	-	-
236178	Front door window finishing moulding--right (Used on 1143)	-	-	-	-	-	-	-	-	1	-
236179	Front door window finishing moulding--left (Used on 1143)	-	-	-	-	-	-	-	-	1	-
236180	Front door window finishing moulding--right (Used on 1153)	-	-	-	-	-	-	-	-	1	-
236181	Front door window finishing moulding--left (Used on 1153)	-	-	-	-	-	-	-	-	1	-
236018	Front door window finishing moulding--right (Used on 1119-1107)	-	-	-	-	-	-	1	-	1	-
236016	Front door window finishing moulding--right (Used on 1139-1127)	-	-	-	-	-	-	1	-	1	-
236019	Front door window finishing moulding--left (Used on 1119-1107)	-	-	-	-	-	-	1	-	1	-
236017	Front door window finishing moulding--left (Used on 1139-1127)	-	-	-	-	-	-	1	-	1	-
231766	Front door window finishing moulding--right (Used on 1136)	-	-	-	-	1	-	-	-	-	-
231767	Front door window finishing moulding--left (Used on 1136)	-	-	-	-	1	-	-	-	-	-
231568	Front door window finishing moulding--right (Used on 1132-1133-34-35-37)	1	1	1	1	-	1	-	-	-	-
231569	Front door window finishing moulding--left (Used on 1132-33-34-35-37)	1	1	1	1	-	1	-	-	-	-
231764	Front door window finishing moulding--right (Used on 1138)	-	-	-	-	-	-	1	-	-	-
231765	Front door window finishing moulding--left (Used on 1138)	-	-	-	-	-	-	1	-	-	-
235771	Front door window finishing moulding wood screw ferrule No. 6	x	x	x	x	x	x	x	x	x	x
228239	Front door window to folding pillar weatherstrip (Black)	-	-	-	-	-	-	-	x	-	x
228238	Front door window to folding pillar weatherstrip (Tan)	-	-	-	-	-	-	-	x	-	x
227852	Front door window to folding pillar weatherstrip retainer--right	-	-	-	-	-	-	1	-	1	-
227853	Front door window to folding pillar weatherstrip retainer--left	-	-	-	-	-	-	1	-	1	-

Piece No.	Name (16th Series)	No. Required									
		1112-1132 5 P. Formal Sedan	1103-13-33 5 P. Tour. Sedan	1114-34 7 P. Tour. Sedan	1115-35 7 P. Tour. Sedan Lim.	1116-36 5 P. Club Sedan	1117-37 5 P. Coupe	1118-38 2-4 P. Coupe	1119-39 2-4 P. Conv. Coupe	1143-53 5 P. Conv. Sedan	1107-27 5 P. Victoria
228239	Front door window to front pillar weather-strip (Black)	-	-	-	-	-	-	-	X	X	X
228238	Front door window to front pillar weather-strip (Tan)	-	-	-	-	-	-	-	X	X	X
227840	Front door window to front pillar weather-strip retainer--right	-	-	-	-	-	-	-	1	1	1
227841	Front door window to front pillar weather-strip retainer--left	-	-	-	-	-	-	-	1	1	1
6460	Screw No. 8-32 x 3/8 flat hd.	-	-	-	-	-	-	-	6	6	6
220624	Front door window glass (Used on 1103-1116-36)	-	2	-	-	2	-	-	-	-	-
220634	Front door window glass (Used on 1112-13-14-15-17-1132-1133-34-35-37)	2	2	2	2	-	2	-	-	-	-
228375	Front door window glass	-	-	-	-	-	-	2	-	-	-
236627	Front door window glass	-	-	-	-	-	-	-	-	2	-
227700	Front door window glass	-	-	-	-	-	-	-	2	-	2
230590	Front door window glass and frame assembly--right	-	-	-	-	-	-	-	1	-	1
230591	Front door window glass and frame assembly--left	-	-	-	-	-	-	-	1	-	1
236636	Front door window glass and frame assembly--right	-	-	-	-	-	-	-	-	1	-
236637	Front door window glass and frame assembly--left	-	-	-	-	-	-	-	-	1	-
230555	Front door window glass and frame assembly--belt anti-rattler	-	-	-	-	-	-	-	2	-	2
236001	Front door window glass and frame assembly--belt anti-rattler	-	-	-	-	-	-	-	-	2	-
308133	Screw No. 6 x 1/2 flat hd. (Parker Kalon) Type A	-	-	-	-	-	-	-	16	16	16
0243910	Front door window glass frame--right	-	-	-	-	-	-	-	1	-	1
0243911	Front door window glass frame--left	-	-	-	-	-	-	-	1	-	1
0243931	Front door window glass frame--right	-	-	-	-	-	-	-	-	1	-
0243932	Front door window glass frame--left	-	-	-	-	-	-	-	-	1	-
0243914	Front door window glass cushion--bottom	-	-	-	-	-	-	-	1	1	1
0243915	Front door window glass cushion--upper	-	-	-	-	-	-	-	1	1	1
236002	Front door window glass frame guide--right	-	-	-	-	-	-	-	1	-	1
236196	Front door window glass frame guide--right	-	-	-	-	-	-	-	-	1	-
236003	Front door window glass frame guide--left	-	-	-	-	-	-	-	1	-	1
236197	Front door window glass frame guide--left	-	-	-	-	-	-	-	-	1	-
5701	Screw 1/4-28 x 9/16 flat hd.	-	-	-	-	-	-	-	6	6	6
228239	Front door window to header weatherstrip (Black)	-	-	-	-	-	-	-	X	X	X
228238	Front door window to header weatherstrip (Tan)	-	-	-	-	-	-	-	X	X	X
236976	Front door window to header weatherstrip retainer--right	-	-	-	-	-	-	-	1	-	1
236977	Front door window to header weatherstrip retainer--left	-	-	-	-	-	-	-	1	-	1
236978	Front door window to header weatherstrip retainer--right	-	-	-	-	-	-	-	-	1	-
236979	Front door window to header weatherstrip retainer--left	-	-	-	-	-	-	-	-	1	-
6460	Screw No. 8-32 x 3/8 flat hd.	-	-	-	-	-	-	-	6	6	6

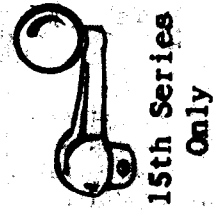

15th Series Only



235848
241114



327463



230675

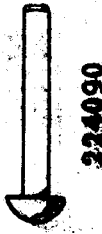

224090

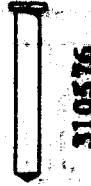

310576



235042



15th Series Only



325873

25014

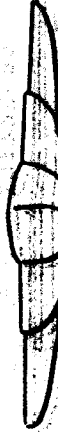

15th Series Only

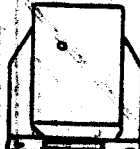

199965



235559



230588
231820



235986-7

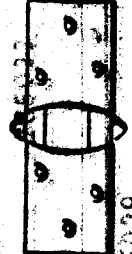

224100-1-2-6-7



229293-4
230578-9



227704-5



225576



236080-1



236002-236003



236196-236197

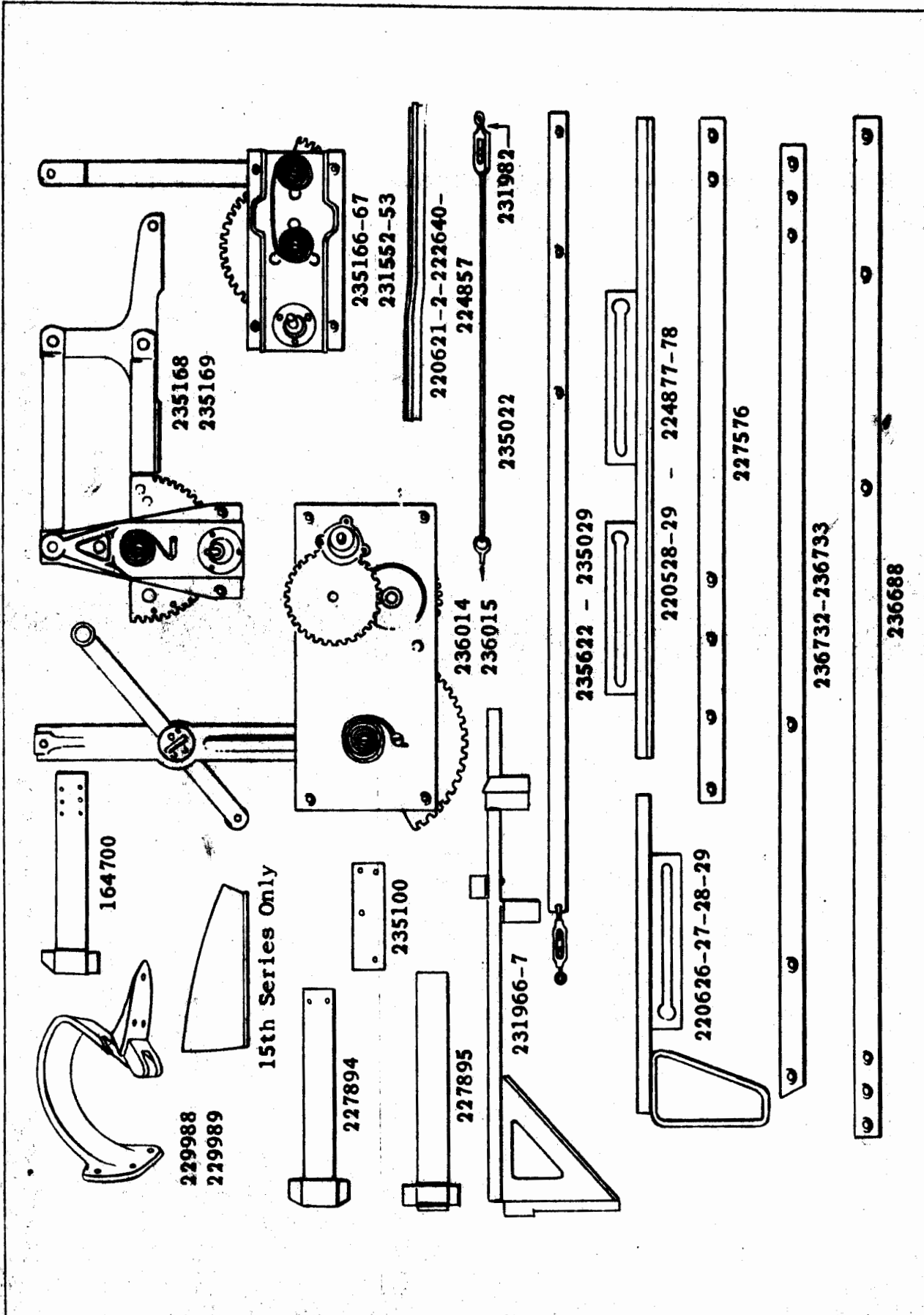

Piece No.	Name	(16th Series)									
		1112-1132 S P. Formal Sedan	1103-13-33 S P. Tour. Sedan	1114-34 7 P. Tour. Sedan	1115-35 7 P. Tour. Sedan Lim.	1116-36 S P. Club Sedan	1117-37 S P. Coupe	1118-38 2-4 P. Coupe	1119-39 2-4 P. Conv. Coupe	1143-93 S P. Conv. Sedan	1107-27 S P. Victoria
		No. Required									
220626	Front door window lifter assembly--right (Used on 1103-16-36)	-	1	-	-	1	-	-	-	-	-
220627	Front door window lifter assembly--left (Used on 1103-16-36)	-	1	-	-	1	-	-	-	-	-
220628	Front door window lifter assembly--right (Not used on 1103)	1	1	1	1	-	1	1	-	-	-
220629	Front door window lifter assembly--left (Not used on 1103)	1	1	1	1	-	1	1	-	-	-
0243912	Front door window lifter assembly--right ...	-	-	-	-	-	-	-	1	-	1
0243913	Front door window lifter assembly--left	-	-	-	-	-	-	-	1	-	1
0243933	Front door window lifter assembly--right ...	-	-	-	-	-	-	-	-	1	-
0243934	Front door window lifter assembly--left	-	-	-	-	-	-	-	-	1	-
220622	Front door window lifter bumper (Used on 1103-1116-36)	-	2	-	-	2	-	-	-	-	-
220640	Front door window lifter bumper (Not used on 1103)	2	2	2	2	-	2	2	-	-	-
235166	Front door window regulator assembly--right (Used on 1103-1116-36)	-	1	-	-	1	-	-	-	-	-
235167	Front door window regulator assembly--left (Used on 1103-1116-36)	-	1	-	-	1	-	-	-	-	-
231552	Front door window regulator assembly--right (Not used on 1103)	1	1	1	1	-	1	1	-	-	-
231553	Front door window regulator assembly--left (Not used on 1103)	1	1	1	1	-	1	1	-	-	-
236014	Front door window regulator assembly--right.	-	-	-	-	-	-	-	1	1	1
236015	Front door window regulator assembly--left .	-	-	-	-	-	-	-	1	1	1
8214	Screw 1/4-28 x 3/4 flat hd.	8	8	8	8	8	8	8	-	-	-
6551	Screw 1/4-20 x 3/4 flat hd.	-	-	-	-	-	-	-	10	10	10
236012	Front door window regulator assembly to lock board washer	-	-	-	-	-	-	-	10	10	10
227371	Front door window regulator arm stop	-	-	-	-	-	-	-	2	2	2
241113	Front door window regulator handle (tenite knob)	2	2	2	2	2	2	2	2	2	2
243880	Front door window regulator handle (chrome knob)	2	2	2	2	2	2	2	2	2	2
241115	Front door window regulator handle escutcheon plate	2	2	2	2	2	2	2	2	2	2
133264	Front door window regulator handle escutcheon plate spring	2	2	2	2	2	2	2	2	2	2
133339	Front door window regulator handle insert ..	2	2	2	2	2	2	2	2	2	2
132972	Front door window regulator handle pin	2	2	2	2	2	2	2	2	2	2
331591	Front door window regulator handle washer ..	2	2	2	2	2	2	2	2	2	2
227656	Front door window regulator lock board cam-- right	-	-	-	-	-	-	-	1	1	1
227657	Front door window regulator lock board cam-- left	-	-	-	-	-	-	-	1	1	1
0243922	Front door window runway--front upper	-	-	-	-	-	-	-	1	1	1
0243923	Front door window runway--front lower	-	-	-	-	-	-	-	1	1	1
220693	Front door window runway--front lower	2	2	2	2	2	2	2	-	-	-
175763	Screw No. 4 x 3/8 flat hd. (Parker Kalon)	4	4	4	4	4	4	4	-	-	-
220694	Front door window runway--front upper	2	2	2	2	2	2	2	-	-	-
6347	Screw No. 8-32 x 1/4 flat hd.	4	4	4	4	4	4	4	-	-	-
220695	Front door window runway--rear lower	2	2	2	2	2	2	2	-	-	-
220689	Front door window runway--rear upper (Used on 1103-1116-36)	-	2	-	-	2	-	-	-	-	-

Piece No.	Name (16th Series)	No. Required								
		1112-1132 5 P. Formal Sedan	1103-13-33 5 P. Tour. Sedan	1114-34 7 P. Tour. Sedan	1115-35 7 P. Tour. Sedan Lim.	1116-36 5 P. Club Sedan	1117-37 5 P. Coupe	1118-38 2-4 P. Coupe	1119-39 2-4 P. Conv. Coupe	1143-53 5 P. Conv. Sedan
220698	Front door window runway--rear upper (Not used on 1103)	2	2	2	2	-	2	-	-	-
228330	Front door window runway--rear upper	-	-	-	-	-	-	2	-	-
231966	Front door window runway retainer assembly--front right	1	1	1	1	1	1	1	-	-
231967	Front door window runway retainer assembly--front left	1	1	1	1	1	1	1	-	-
163168	Front door window runway retainer--rear	2	2	2	2	2	2	2	-	-
136008	Front door window runway shim 1/32 x 1/2 x 40"	x	x	x	x	x	x	x	-	-
132429	Front door window runway shim 1/16 x 1/2 x 40"	x	x	x	x	x	x	x	-	-
131316	Front door window stop block bumper	2	2	2	2	2	2	2	-	-
227887	Front door window stop bumper	-	-	-	-	-	-	-	2	2
8224	Screw No. 10-32 x 5/8 flat hd.	-	-	-	-	-	-	-	2	2
227385	Front door window stop bumper bracket	-	-	-	-	-	-	-	2	2
220653	Front door window wing assembly--left	1	1	1	1	1	1	1	-	-
220652	Front door window wing assembly--right	1	1	1	1	1	1	1	-	-
236862	Front door window wing assembly--right	-	-	-	-	-	-	-	1	1
236863	Front door window wing assembly--left	-	-	-	-	-	-	-	1	1
6448	Screw 1/4-20 x 3/4 hex. hd.	4	4	4	4	4	4	4	-	-
5447	Lockwasher 1/4 (Shakeproof)	4	4	4	4	4	4	4	-	-
220620	Front door window wing glass	2	2	2	2	2	2	2	-	-
227701	Front door window wing glass	-	-	-	-	-	-	-	2	2
228272	Front door window wing glass cushion	x	x	x	x	x	x	x	-	-
211649	Front door window wing glass cushion	x	x	x	x	x	x	x	-	-
229324	Front door window wing glass cushion	x	x	x	x	x	x	x	-	-
0243916	Front door window wing glass frame and pivot--right	-	-	-	-	-	-	-	1	1
0243917	Front door window wing glass frame and pivot--left	-	-	-	-	-	-	-	1	1
0328866	Front door window wing glass and retainer assembly--right	-	-	-	-	-	-	-	1	1
0328865	Front door window wing glass and retainer assembly--left	-	-	-	-	-	-	-	1	1
220625	Front door window wing glass and retainer assembly	2	2	2	2	2	2	2	-	-
220618	Front door window wing glass retainer front assembly	2	2	2	2	2	2	2	-	-
220633	Front door window wing glass retainer rear assembly	2	2	2	2	2	2	2	-	-
212366	Front door window wing glass retainer screw No. 4 x 3/16 (Parker Kalon) Type Z special hd.	4	4	4	4	4	4	4	-	-
220575	Front door window wing glass retainer pivot lower	2	2	2	2	2	2	2	-	-
220600	Front door window wing glass retainer pivot lower spacer	x	x	x	x	x	x	x	-	-
211409	Front door window wing glass retainer pivot--upper	2	2	2	2	2	2	2	-	-
212490	Front door window wing glass retainer pivot--upper-spring	2	2	2	2	2	2	2	-	-
0243918	Front door window wing regulator assembly--right	-	-	-	-	-	-	-	1	1
0243919	Front door window wing regulator assembly--left	-	-	-	-	-	-	-	1	1

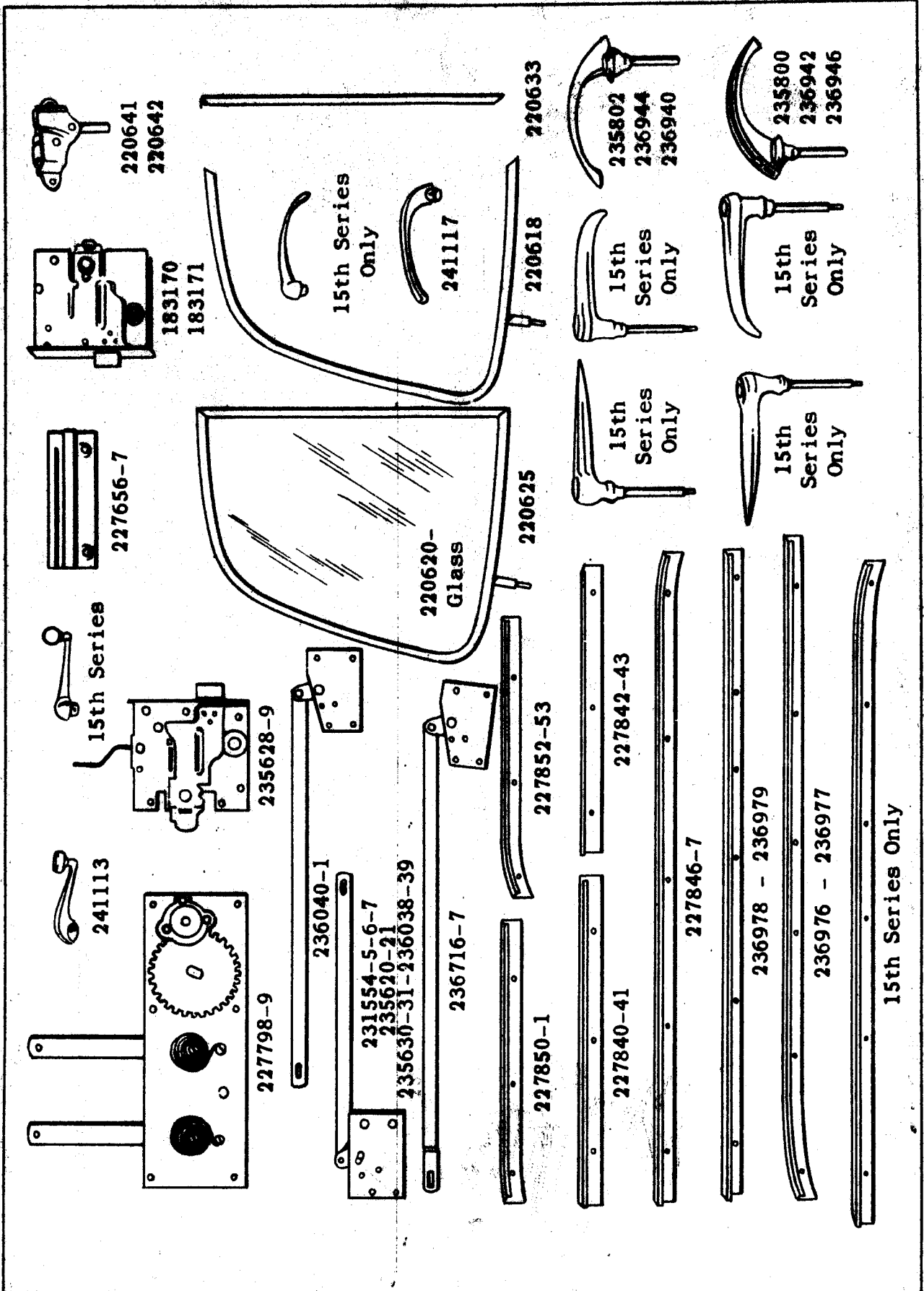

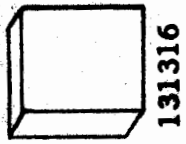

131316



326030

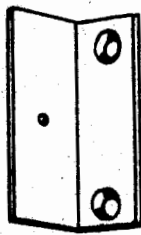

227385

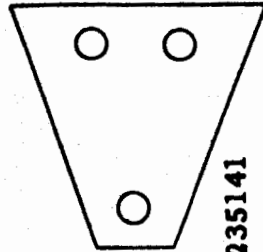

235141



15th Series
Only



227888



235956



327342

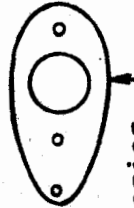

15th Series



241115

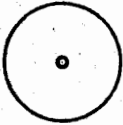

308103

308102

310588



212490

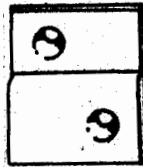

229996

229997



15th Series



15th Series



227886

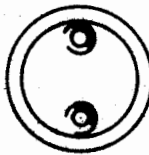

227839



15th Series
Only



235046



15th Series

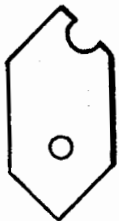

164359



227893

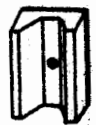

227887

15th Series
Only

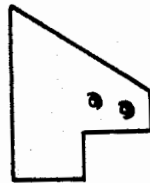

227518

227519



235849

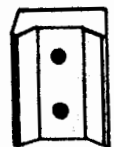

195717

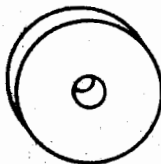

199167



133264

185600-1-2

218685

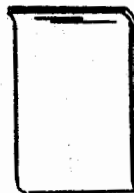

227371



15th Series
Only



235854

Piece No.	Name	(16th Series)									
		1112-1132 S P. Formal Sedan	1103-13-33 S P. Tour. Sedan	1114-34 7 P. Tour. Sedan	1115-35 7 P. Tour. Sedan Lim.	1116-36 S P. Club Sedan	1117-37 S P. Coupe	1118-38 2-4 P. Coupe	1119-39 2-4 P. Conv. Coupe	1143-53 S P. Conv. Sedan	1107-27 9 P. Victoria
		No. Required									
220641	Front door window wing regulator assy.--rt..	1	1	1	1	1	1	1	-	-	-
220642	Front door window wing regulator assy.--lt..	1	1	1	1	1	1	1	-	-	-
7837	Screw 1/4-20 x 7/8 hex. hd.	4	4	4	4	4	4	4	-	-	-
5502	Lockwasher 1/4	4	4	4	4	4	4	4	-	-	-
235848	Front door window wing regulator handle (tenite knob) (Used on 1132-33-34-35-36- 37-38-39-1153-1127)	2	2	2	2	2	2	2	2	2	2
241114	Front door window wing regulator handle (tenite knob) (Used on 1103-1112-13-14-15- 16-17-18-19-07-43)	2	2	2	2	2	2	2	2	2	2
243894	Front door window wing regulator handle (chrome knob) (Used on 1132-33-34-35-36- 37-38-39-53-37)	2	2	2	2	2	2	2	2	2	2
243881	Front door window wing regulator handle (chrome knob) (Used on 1103-12-13-14-15- 16-17-18-19-07-43)	-	-	-	-	-	-	-	2	2	2
147910	Front door window wing regulator handle screw (Used on 1132-33-34-35-36-37-38-39- 1127-53)	2	2	2	2	2	2	2	2	2	2
235854	Front door window wing regulator handle escutcheon plate (Used on 1112-1103-13- 14-15-16-17-18-19-1107-43)	2	2	2	2	2	2	2	2	2	2
235849	Front door window wing regulator handle escutcheon plate (Used on 1132-33-34-35- 36-37-38-39-1127-53)	2	2	2	2	2	2	2	2	2	2
133264	Front door window wing regulator handle escutcheon plate spring (Used on 1112- 1103-13-14-15-16-17-18-19-1107-43)	2	2	2	2	2	2	2	2	2	2
133339	Front door window wing regulator handle insert	2	2	2	2	2	2	2	2	2	2
132972	Front door window wing regulator handle pin (Used on 1103-12-13-14-15-16-17-18-19- 1107-43)	2	2	2	2	2	2	2	2	2	2
331591	Front door window wing regulator handle washer	2	2	2	2	2	2	2	2	2	2
235656	Front door window wing water deflector--rt..	1	1	1	1	1	1	1	-	-	-
235657	Front door window wing water deflector--lt..	1	1	1	1	1	1	1	-	-	-
220650	Front door window wing weatherstrip assembly--right	1	1	1	1	1	1	1	-	-	-
220651	Front door window wing weatherstrip assembly--left	1	1	1	1	1	1	1	-	-	-
0227830	Front door window wing weatherstrip assembly--rear right	-	-	-	-	-	-	-	1	1	1
0227831	Front door window wing weatherstrip assembly--rear left	-	-	-	-	-	-	-	1	1	1
0236902	Front door window wing weatherstrip--upper right	-	-	-	-	-	-	-	1	1	1
0236903	Front door window wing weatherstrip--upper left	-	-	-	-	-	-	-	1	1	1
0236900	Front door window wing weatherstrip--lower right	-	-	-	-	-	-	-	1	1	1
0236901	Front door window wing weatherstrip--lower left	-	-	-	-	-	-	-	1	1	1
199167	Rear door anti-rattler	2	2	2	2	2	-	-	-	-	-
218305	Rear door anti-rattler shim	x	x	x	x	x	-	-	-	-	-

Piece No.	Name	(16th Series)									
		1112-1132 5 P. Formal Sedan	1103-13-33 5 P. Tour. Sedan	1114-34 7 P. Tour. Sedan	1115-35 7 P. Tour. Sedan Lim.	1116-36 5 P. Club Sedan	1117-37 5 P. Coupe	1118-38 2-4 P. Coupe	1119-39 2-4 P. Conv. Coupe	1143-53 5 P. Conv. Sedan	1107-27 5 P. Victoria
		No. Required									
185602	Rear door bumper (1-9/32)	x	x	x	x	x	-	-	-	x	-
185601	Rear door bumper (1-11/32)	x	x	x	x	x	-	-	-	x	-
185600	Rear door bumper (1-13/32)	x	x	x	x	x	-	-	-	x	-
218685	Rear door bumper (1-15/32)	x	x	x	x	x	-	-	-	x	-
227886	Rear door bumper--intermediate	-	-	-	-	-	-	-	-	2	-
227888	Rear door bumper--lower	-	-	-	-	-	-	-	-	2	-
227839	Rear door bumper--lower--striker	-	-	-	-	-	-	-	-	2	-
164700	Rear door check strap	2	2	2	2	2	-	-	-	-	-
227894	Rear door check strap	-	-	-	-	-	-	-	-	2	-
164359	Rear door check strap fastener plate	2	2	2	2	2	-	-	-	-	-
227893	Rear door check strap fastener plate	-	-	-	-	-	-	-	-	2	-
6837	Screw No. 10-24 x 7/8 rnd. hd.	-	-	-	-	-	-	-	-	4	-
227897	Rear door check strap guide	-	-	-	-	-	-	-	-	2	-
5829	Screw No. 10-32 x 7/8 flat hd.	-	-	-	-	-	-	-	-	4	-
199965	Rear door check strap guide assembly	2	2	2	2	2	-	-	-	-	-
227576	Rear door diagonal brace	-	-	-	-	-	-	-	-	2	-
236012	Washer countersunk	-	-	-	-	-	-	-	-	4	-
235042	Rear door dovetail--female	2	2	2	2	2	-	-	-	2	-
235046	Rear door dovetail--male	2	2	2	2	2	-	-	-	2	-
224107	Rear door hinge lower--right	1	1	-	-	-	-	-	-	-	-
224106	Rear door hinge lower--left	1	1	-	-	-	-	-	-	-	-
224101	Rear door hinge lower--right	-	-	1	1	1	-	-	-	-	-
236078	Rear door hinge lower--right	-	-	-	-	-	-	-	-	1	-
224100	Rear door hinge lower--left	-	-	1	1	1	-	-	-	-	-
236079	Rear door hinge lower--left	-	-	-	-	-	-	-	-	1	-
224103	Rear door hinge upper--right	-	1	1	1	-	-	-	-	-	-
224102	Rear door hinge upper--left	-	1	1	1	-	-	-	-	-	-
229224	Rear door hinge upper--right	1	-	-	-	1	-	-	-	-	-
229223	Rear door hinge upper--left	1	-	-	-	1	-	-	-	-	-
236080	Rear door hinge upper--right	-	-	-	-	-	-	-	-	1	-
236081	Rear door hinge upper--left	-	-	-	-	-	-	-	-	1	-
228203	Rear door hinge screw 5/16-24 x 5/8 flat hd.	-	-	-	-	-	-	-	-	16	-
5854	Rear door hinge screw 1/4-28 x 1-1/4 flat hd.	2	2	2	2	2	-	-	-	-	-
5747	Screw 1/4-28 x 1-5/8 flat hd.	2	2	2	2	2	-	-	-	-	-
5820	Screw 1/4-28 x 1-31/32 oval hd.	4	4	4	4	4	-	-	-	-	-
227915	Screw 5/16-24 x 17/32 flat hd. special.	-	-	-	-	-	-	-	-	16	-
5899	Lockwasher 5/16 countersunk (Shakeproof)	-	-	-	-	-	-	-	-	32	-
227515	Rear door hinge pillar finishing plate--left	-	-	-	-	-	-	-	-	1	-
227514	Rear door hinge pillar finishing plate--right	-	-	-	-	-	-	-	-	1	-
6905	Screw No. 4-40 x 3/8 Phillips O.H. self-tapping	-	-	-	-	-	-	-	-	10	-
224090	Rear door hinge pin	4	4	4	4	4	-	-	-	-	-
230588	Rear door hinge pin	-	-	-	-	-	-	-	-	4	-
218600	Rear door hinge pin screw	4	4	4	4	4	-	-	-	-	-
231821	Rear door hinge pin screw	-	-	-	-	-	-	-	-	4	-
5500	Lockwasher No. 10	4	4	4	4	4	4	-	-	4	-
235628	Rear door lock--right	1	1	1	1	1	-	-	-	-	-
235629	Rear door lock--left	1	1	1	1	1	-	-	-	-	-
183170	Rear door lock--right	-	-	-	-	-	-	-	-	1	-
183171	Rear door lock--left	-	-	-	-	-	-	-	-	1	-
8022	Screw No. 10-32 x 3/8 oval hd.	-	-	-	-	-	-	-	-	4	-
5829	Screw No. 10-32 x 7/8 flat hd.	4	4	4	4	4	-	-	-	4	-
5491	Lockwasher 3/16 countersunk (Shakeproof)	4	4	4	4	4	-	-	-	4	-
235800	Rear door lock handle (With key lock) (With partition for 1113-33)	1	1	-	1	-	-	-	-	-	-
235802	Rear door lock handle	1	2	2	1	2	-	-	-	-	-

Piece No.	Name	(16th Series)										
		1112-1132 S P. Formal Sedan	1103-13-33 S P. Tour. Sedan	1114-34 7 P. Tour. Sedan	1115-35 7 P. Tour. Sedan Lim.	1116-36 S P. Club Sedan	1117-37 S P. Coupe	1118-38 2-4 P. Coupe	1119-39 2-4 P. Conv. Coupe	1143-53 S P. Conv. Sedan	1157-57 S P. Victoria	
		No. Required										
236940	Rear door lock handle (1 required with partition)	-	-	-	-	-	-	-	-	-	2	-
236942	Rear door lock handle--right (Use with partition only)	-	-	-	-	-	-	-	-	-	1	-
326030	Rear door lock handle cylinder lock	1	-	-	1	-	-	-	-	-	-	-
6775	Rear door lock handle screw No. 12-24 x 7/16 (Phillips) rnd. hd.	2	2	2	2	2	-	-	-	-	2	-
6719	Lockwasher No. 12 (Shakeproof)	2	2	2	2	2	-	-	-	-	2	-
327342	Rear door lock handle gasket	2	2	2	2	2	-	-	-	-	2	-
327463	Rear door lock plunger lock knob	2	2	2	2	2	-	-	-	-	-	-
235620	Rear door lock remote control--right (Used on 1103-14-15-16-34-35-36)	-	1	1	1	1	-	-	-	-	-	-
235621	Rear door lock remote control--left (Used on 1103-14-15-16-34-35-36)	-	1	1	1	1	-	-	-	-	-	-
235630	Rear door lock remote control--right (Used on 1112-13-1132-33)	1	1	-	-	-	-	-	-	-	-	-
235631	Rear door lock remote control--left (Used on 1112-13-1132-33)	1	1	-	-	-	-	-	-	-	-	-
236038	Rear door lock remote control--right	-	-	-	-	-	-	-	-	-	1	-
236039	Rear door lock remote control--left	-	-	-	-	-	-	-	-	-	1	-
241117	Rear door lock remote control handle	2	2	2	2	2	-	-	-	-	2	-
241115	Rear door lock remote control handle escutcheon plate	2	2	2	2	2	-	-	-	-	2	-
133264	Rear door lock remote control handle, escutcheon plate spring	2	2	2	2	2	-	-	-	-	2	-
133339	Rear door lock remote control handle insert.	2	2	2	2	2	-	-	-	-	2	-
132972	Rear door lock remote control handle pin ...	2	2	2	2	2	-	-	-	-	2	-
229997	Rear door lock striker (Used on 1112-1103-1113-14-15-16)	2	2	2	2	2	-	-	-	-	-	-
229996	Rear door lock striker (Used on 1132-1133-34-35-36-1143-1153)	2	2	2	2	2	-	-	-	-	2	-
6835	Screw No. 12-24 x 7/8 flat hd.	-	-	-	-	-	-	-	-	-	4	-
241150	Rear door panel assembly--right	1	-	-	-	-	-	-	-	-	-	-
241151	Rear door panel assembly--left	1	-	-	-	-	-	-	-	-	-	-
241148	Rear door panel assembly--right (Used on 1103)	-	1	-	-	-	-	-	-	-	-	-
241149	Rear door panel assembly--left (Used on 1103)	-	1	-	-	-	-	-	-	-	-	-
241152	Rear door panel assembly--right (Used on 1113-33)	-	1	-	-	-	-	-	-	-	-	-
241153	Rear door panel assembly--left (Used on 1113-33)	-	1	-	-	-	-	-	-	-	-	-
241154	Rear door panel assembly--right	-	-	1	1	-	-	-	-	-	-	-
241155	Rear door panel assembly--left	-	-	1	1	-	-	-	-	-	-	-
241156	Rear door panel assembly--right	-	-	-	-	1	-	-	-	-	-	-
241157	Rear door panel assembly--left	-	-	-	-	1	-	-	-	-	-	-
241304	Rear door panel assembly--right	-	-	-	-	-	-	-	-	-	1	-
241305	Rear door panel assembly--left	-	-	-	-	-	-	-	-	-	1	-
325873	Rear door trim panel moulding (Used on 1112-1103-1113-14-15-16-1143) (Antiqua Tan) ...	2	2	2	2	2	-	-	-	-	2	-
243818	Rear door trim panel moulding (Used on 1112-1103-1113-14-15-16-1143) (Walnut)	2	2	2	2	2	-	-	-	-	2	-
235022	Rear door truss assembly	4	4	4	4	4	-	-	-	-	-	-
231982	Rear door truss turnbuckle	4	4	4	4	4	-	-	-	-	-	-
241285	Rear door weatherstrip--86" long	2	2	2	2	2	-	-	-	-	-	-
241283	Rear door weatherstrip--19" long	2	2	-	-	-	-	-	-	-	-	-

Piece No.	Name (16th Series)	No. Required									
		1112-1132 S P. Formal Sedan	1103-13-33 S P. Tour. Sedan	1114-34 7 P. Tour. Sedan	1115-35 7 P. Tour. Sedan Lim.	1116-36 S P. Club Sedan	1117-37 S P. Coupe	1118-38 2-4 P. Coupe	1119-39 2-4 P. Conv. Coupe	1143-43 S P. Conv. Sedan	1107-27 S P. Victoria
241286	Rear door weatherstrip--22" long	-	-	2	2	2	-	-	-	-	-
241287	Rear door weatherstrip--26" long	-	-	2	2	2	-	-	-	-	-
241288	Rear door weatherstrip--34" long	2	2	-	-	-	-	-	-	-	-
314936	Clip	X	X	X	X	X	-	-	-	-	-
228239	Rear door window to center removable pillar weatherstrip (Black)	-	-	-	-	-	-	-	-	X	-
228238	Rear door window to center removable pillar weatherstrip (Tan)	-	-	-	-	-	-	-	-	X	-
227842	Rear door window to center removable pillar weatherstrip retainer--right	-	-	-	-	-	-	-	-	1	-
227843	Rear door window to center removable pillar weatherstrip retainer--left	-	-	-	-	-	-	-	-	1	-
235640	Rear door window finishing moulding assembly right (Used on 1103-14-15-16) (Antiqua Tan)	-	1	1	1	1	-	-	-	-	-
243972	Rear door window finishing moulding assembly right (Used on 1103-14-15-16) (Walnut) ...	-	1	1	1	1	-	-	-	-	-
235641	Rear door window finishing moulding assembly left (Used on 1103-1114-15-16) (Antiqua Tan)	-	1	1	1	1	-	-	-	-	-
243973	Rear door window finishing moulding assembly left (Used on 1103-1114-15-16) (Walnut) ..	-	1	1	1	1	-	-	-	-	-
235646	Rear door window finishing moulding assembly right (Used on 1112-13) (Antiqua Tan)	1	1	-	-	-	-	-	-	-	-
243970	Rear door window finishing moulding assembly right (Used on 1112-13) (Walnut)	1	1	-	-	-	-	-	-	-	-
235647	Rear door window finishing moulding assembly left (Used on 1112-13) (Antiqua Tan)	1	1	-	-	-	-	-	-	-	-
243971	Rear door window finishing moulding assembly left (Used on 1112-13) (Walnut)	1	1	-	-	-	-	-	-	-	-
235648	Rear door window finishing moulding--right (Used on 1134-35-36)	-	-	1	1	1	-	-	-	-	-
235649	Rear door window finishing moulding--left (Used on 1134-35-36)	-	-	1	1	1	-	-	-	-	-
235650	Rear door window finishing moulding--right (Used on 1132-1133)	1	1	-	-	-	-	-	-	-	-
235651	Rear door window finishing moulding--left (Used on 1132-1133)	1	1	-	-	-	-	-	-	-	-
236184	Rear door window finishing moulding--right (Used on 1153)	-	-	-	-	-	-	-	-	1	-
236185	Rear door window finishing moulding--left (Used on 1153)	-	-	-	-	-	-	-	-	1	-
236182	Rear door window finishing moulding--right (Used on 1143)	-	-	-	-	-	-	-	-	1	-
236183	Rear door window finishing moulding--left (Used on 1143)	-	-	-	-	-	-	-	-	1	-
235771	Rear door window finishing moulding wood screw ferrule No. 6	X	X	X	X	X	-	-	-	X	-
228239	Rear door window to folding pillar weatherstrip (Black)	-	-	-	-	-	-	-	-	X	-
228238	Rear door window to folding pillar weatherstrip (Tan)	-	-	-	-	-	-	-	-	X	-
227850	Rear door window to folding pillar weatherstrip retainer--right	-	-	-	-	-	-	-	-	1	-
227851	Rear door window to folding pillar weatherstrip retainer--left	-	-	-	-	-	-	-	-	1	-

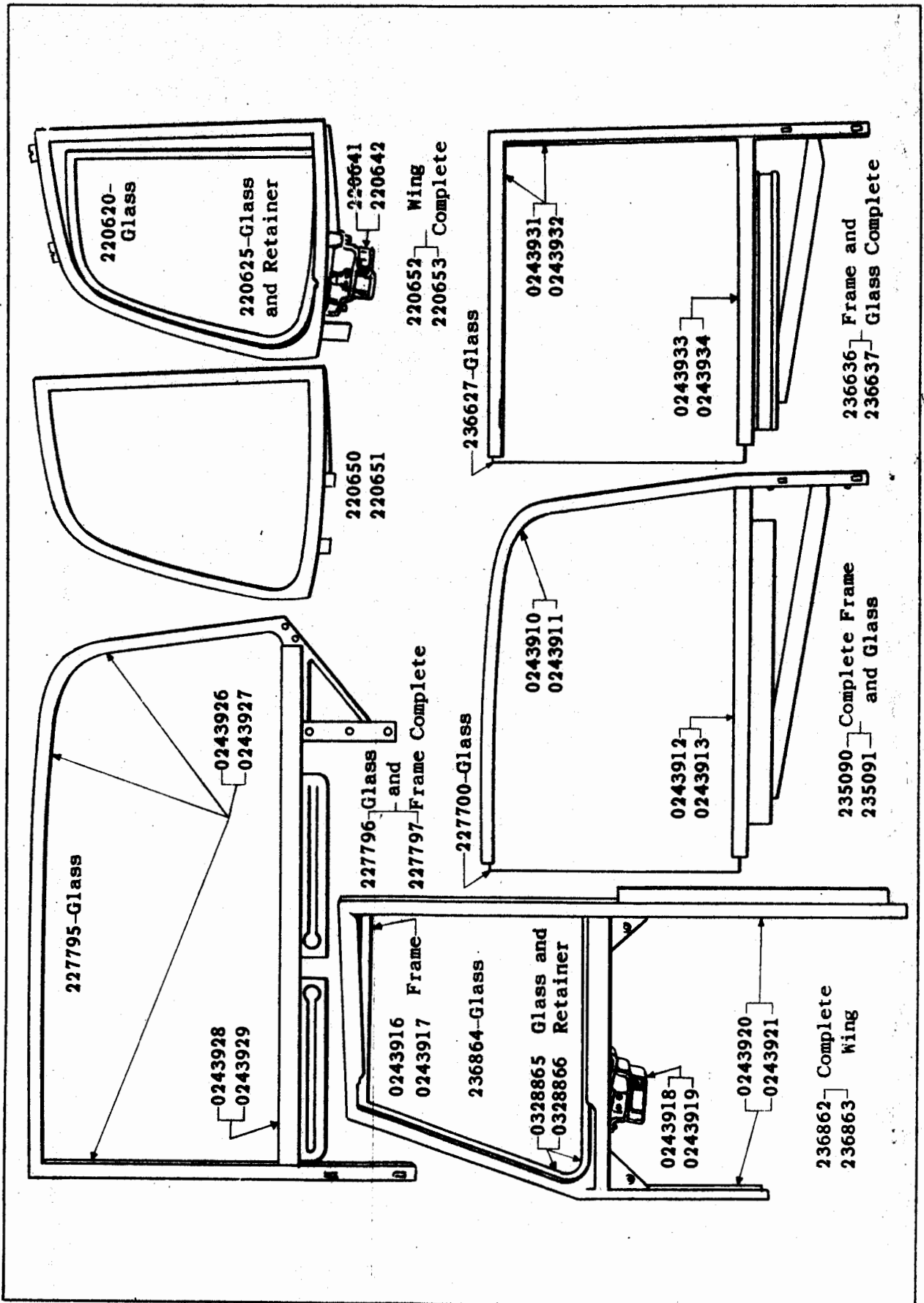











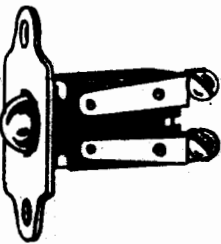
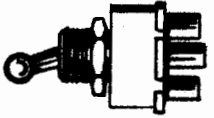
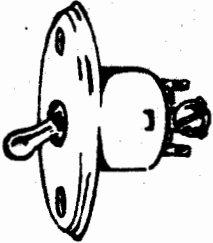
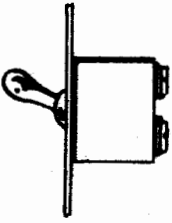
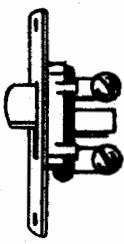

Piece No.	Name	No. Required									
		1112-1132 5 P. Formal Sedan	1103-13-33 5 P. Tour. Sedan	1114-34 7 P. Tour. Sedan	1115-35 7 P. Tour. Sedan Lim.	1116-36 5 P. Club Sedan	1117-37 5 P. Coupe	1118-38 2-4 P. Coupe	1119-39 2-4 P. Conv. Coupe	1142-43 5 P. Conv. Sedan	1107-27 5 P. Victoria
224854	Rear door window glass (Used on 1112-32-1113-33)	2	2	-	-	-	-	-	-	-	-
220530	Rear door window glass (Used on 1103-1114-15-16-1134-35-36)	-	2	2	2	2	-	-	-	-	-
227795	Rear door window glass	-	-	-	-	-	-	-	-	2	-
227796	Rear door window glass and frame assy.--rt.	-	-	-	-	-	-	-	-	1	-
227797	Rear door window glass and frame assy.--lt.	-	-	-	-	-	-	-	-	1	-
230556	Rear door window glass and frame assembly belt anti-rattler--inside	-	-	-	-	-	-	-	-	2	-
230554	Rear door window glass and frame assembly belt anti-rattler--outside	-	-	-	-	-	-	-	-	2	-
308133	Screw No. 6 x 1/2 flat hd. (Parker Kalon)	-	-	-	-	-	-	-	-	6	-
0243926	Rear door window glass frame--right	-	-	-	-	-	-	-	-	1	-
0243927	Rear door window glass frame--left	-	-	-	-	-	-	-	-	1	-
227704	Rear door window glass frame guide--rear rt.	-	-	-	-	-	-	-	-	1	-
227705	Rear door window glass frame guide--rear lt.	-	-	-	-	-	-	-	-	1	-
230536	Rear door window glass frame guide--front rt.	-	-	-	-	-	-	-	-	1	-
230537	Rear door window glass frame guide--front lt.	-	-	-	-	-	-	-	-	1	-
8224	Screw No. 10-32 x 5/8 flat hd.	-	-	-	-	-	-	-	-	8	-
228239	Rear door window to header weatherstrip (Black)	-	-	-	-	-	-	-	-	x	-
228238	Rear door window to header weatherstrip (Tan)	-	-	-	-	-	-	-	-	x	-
227846	Rear door window to header weatherstrip retainer--right	-	-	-	-	-	-	-	-	1	-
227847	Rear door window to header weatherstrip retainer--left	-	-	-	-	-	-	-	-	1	-
220528	Rear door window lifter assembly--right (Used on 1103-14-15-16-34-35-36)	-	1	1	1	1	-	-	-	-	-
220529	Rear door window lifter assembly--left (Used on 1103-14-15-16-34-35-36)	-	1	1	1	1	-	-	-	-	-
224878	Rear door window lifter assembly--right (Used on 1112-13-1132-33)	1	1	-	-	-	-	-	-	-	-
224877	Rear door window lifter assembly--left (Used on 1112-13-1132-33)	1	1	-	-	-	-	-	-	-	-
0243928	Rear door window lifter assembly--right	-	-	-	-	-	-	-	-	1	-
0243929	Rear door window lifter assembly--left	-	-	-	-	-	-	-	-	1	-
224857	Rear door window lifter bumper (Used on 1112-13-1132-33)	2	2	-	-	-	-	-	-	-	-
220621	Rear door window lifter bumper (Used on 1103-1114-15-16-34-35-36)	-	2	2	2	2	-	-	-	-	-
235168	Rear door window regulator--right	1	1	1	1	1	-	-	-	-	-
227798	Rear door window regulator--right	-	-	-	-	-	-	-	-	1	-
235169	Rear door window regulator--left	1	1	1	1	1	-	-	-	-	-
227799	Rear door window regulator--left	-	-	-	-	-	-	-	-	1	-
8214	Screw 1/4-28 x 3/4 flat hd.	4	4	4	4	4	-	-	-	-	-
6551	Screw 1/4-20 x 3/4 flat hd.	-	-	-	-	-	-	-	-	12	-
236012	Washer	-	-	-	-	-	-	-	-	12	-
8202	Screw	2	2	2	2	2	-	-	-	-	-
241113	Rear door window regulator handle (tenite knob)	2	2	2	2	2	-	-	-	2	-
243880	Rear door window regulator handle (chrome knob)	2	2	2	2	2	-	-	-	2	-
241115	Rear door window regulator handle escutcheon plate	2	2	2	2	2	-	-	-	2	-

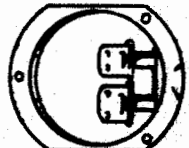
Piece No.	Name	(16th Series)									
		1112-1132 5 P. Formal Sedan	1103-13-33 5 P. Tour. Sedan	1114-34 7 P. Tour. Sedan	1115-35 7 P. Tour. Sedan Lim.	1116-36 5 P. Club Sedan	1117-37 5 P. Coupe	1118-38 2-4 P. Coupe	1119-39 2-4 P. Conv. Coupe	1143-93 5 P. Conv. Sedan	1107-27 5 P. Victoria
		No. Required									
133264	Rear door window regulator handle										
	escutcheon plate spring	2	2	2	2	2	-	-	-	2	-
133339	Rear door window regulator handle insert ...	2	2	2	2	2	-	-	-	2	-
132972	Rear door window regulator handle pin	2	2	2	2	2	-	-	-	2	-
331591	Rear door window regulator handle washer ...	2	2	2	2	2	-	-	-	2	-
220697	Rear door window runway lower	4	4	-	-	-	-	-	-	-	-
220696	Rear door window runway lower	-	-	4	4	4	-	-	-	-	-
224858	Rear door window runway upper (Used on 1112-13-1132-33)	2	2	-	-	-	-	-	-	-	-
220706	Rear door window runway upper (Used on 1103-14-15-16-34-35-36)	-	2	2	2	2	-	-	-	-	-
163168	Rear door window runway retainer	2	2	2	2	2	-	-	-	-	-
136008	Rear door window runway shim 1/32 x 1/2 x 40"	X	X	X	X	X	-	-	-	-	-
132429	Rear door window runway shim 1/16 x 1/2 x 40"	X	X	X	X	X	-	-	-	-	-
0243930	Rear door window sash carriage—rear	-	-	-	-	-	-	-	-	2	-
195717	Rear door window stop bumper	-	-	-	-	-	-	-	-	2	-

ELECTRICAL

33287	Electrical-body feed cable terminal 13/64 eye	X	X	X	X	X	X	-	-	X	X
71397	Electrical-body feed cable terminal 11/64 eye (open end)	X	X	X	X	X	X	X	X	X	X
225377	Electrical-body feed cable terminal 11/64 eye (Used on 1132)	X	-	-	-	-	-	-	-	-	-
36111	Electrical-body feed cable terminal insulator	X	X	X	X	X	X	X	X	X	X
48202	Electrical-body ground cable terminal 1/4 eye	X	X	X	X	X	X	X	-	-	-
33287	Electrical-body ground cable terminal 13/64 eye	-	-	-	-	-	-	-	-	-	X
171863	Electrical-body ground cable terminal (cigar lighter)	-	-	-	-	-	-	-	-	-	X
225377	Electrical-body ground cable terminal 11/64 eye (Used on 1132)	X	-	-	-	-	-	-	-	-	-
5873	Screw 1/4-28 x 9/16 hex. hd.	2	2	2	2	2	2	-	-	-	-
5502	Lockwasher 1/4	2	2	2	2	2	2	-	-	-	-
7004	Nut 1/4-28	2	2	2	2	2	2	-	-	-	-
167069	Electrical-body wiring cable (19 strand No. 16 Ga. Green Braid)	X	X	X	X	X	X	X	X	X	X
179251	Electrical-body wiring cable (19 strand No. 12 Ga. Green Braid)	X	X	X	X	X	X	-	-	X	-
166403	Electrical-body wiring cable (19 strand No. 12 Ga. Red Braid)	X	X	X	X	X	X	-	-	X	-
166406	Electrical-body wiring cable (19 strand No. 16 Ga. Red Braid)	X	X	X	X	X	X	X	X	X	X
166404	Electrical-body wiring cable (19 strand No. 16 Ga. Black Braid)	X	X	X	X	X	X	X	X	X	X
166405	Electrical-body wiring cable (19 strand No. 16 Ga. Black with Red Tracer Braid) ..	X	X	X	X	X	X	X	-	-	-
194286	Electrical-body wiring cable clip (Used on 11132-1133-34-35-36-37-38-39)	2	2	2	2	2	2	2	2	-	-
240635	Electrical-body wiring cable connector tip male	X	X	X	X	X	X	X	-	-	-
224442	Electrical-body wiring cable groove clip ...	X	X	X	X	X	-	-	-	-	-
227878	Electrical-body wiring cable loom—45" long (Body feed cable)	-	-	-	-	-	-	-	-	X	X

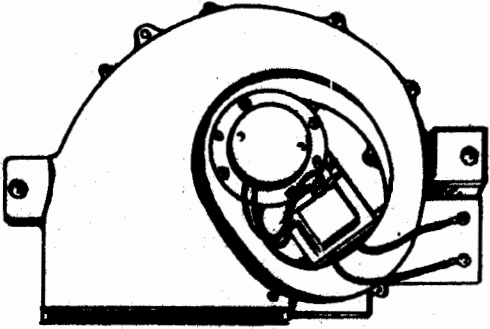
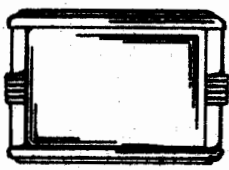
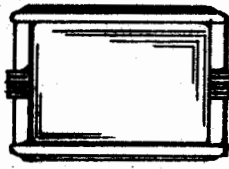
Piece No.	Name (16th Series)	No. Required									
		1112-1132 5 P. Formal Sedan	1103-13-33 5 P. Tour. Sedan	1114-34 7 P. Tour. Sedan	1115-35 7 P. Tour. Sedan Lim	1116-36 5 P. Club Sedan	1117-37 5 P. Coupe	1118-38 2-4 P. Coupe	1119-39 2-4 P. Conv. Coupe	1143-53 5 P. Conv. Sedan	1107-27 5 P. Victoria
236794	Electrical-body wiring cable loom--27" long (cigar lighter cable)	-	-	-	-	-	-	-	-	X	-
236793	Electrical-body wiring cable loom--4" long (door switch and tonneau light cable)	-	-	-	-	-	-	-	-	X	-
29254	Electrical-body wiring cable staple insulated No. 1 x 1/2	X	X	X	X	X	X	X	X	X	X
33287	Electrical-body wiring dome light cable terminal 13/64 eye	5	2	2	5	2	2	2	-	-	-
36111	Electrical-body wiring dome light cable terminal insulator	5	2	2	5	2	2	2	-	-	-
199892	Electrical-dictograph transmitter and winder assembly (6 volt)	-	-	-	1	-	-	-	-	-	-
241247	Electrical-dictograph transmitter and winder assembly (12 volt)	-	-	-	1	-	-	-	-	-	-
133004	Electrical-dictograph winder	-	-	-	1	-	-	-	-	-	-
5696	Screw No. 8-32 x 3/8 rnd. hd.	-	-	-	2	-	-	-	-	-	-
5695	Lockwasher No. 8	-	-	-	2	-	-	-	-	-	-
7002	Nut No. 8-32	-	-	-	2	-	-	-	-	-	-
224265	Electrical-dictograph winder bracket	-	-	-	1	-	-	-	-	-	-
5853	Screw 1/4-28 x 1/2 rnd. hd.	-	-	-	2	-	-	-	-	-	-
5502	Lockwasher 1/4	-	-	-	2	-	-	-	-	-	-
7004	Nut 1/4-28	-	-	-	2	-	-	-	-	-	-
229866	Electrical-dictograph receiver (6 volt)	-	-	-	1	-	-	-	-	-	-
241246	Electrical-dictograph receiver (12 volt) ...	-	-	-	1	-	-	-	-	-	-
235423	Electrical-dictograph receiver support bracket--front	-	-	-	1	-	-	-	-	-	-
5315	Screw 1/4-28 x 1-3/8 hex. hd.	-	-	-	1	-	-	-	-	-	-
62065	Washer 1/4 special	-	-	-	1	-	-	-	-	-	-
7004	Nut 1/4-28	-	-	-	1	-	-	-	-	-	-
229865	Electrical-dictograph receiver support bracket--rear	-	-	-	1	-	-	-	-	-	-
5580	Screw No. 10-32 x 1 flat hd.	-	-	-	2	-	-	-	-	-	-
5870	Screw No. 10-32 x 1/2 rnd. hd.	-	-	-	2	-	-	-	-	-	-
5500	Lockwasher No. 10	-	-	-	4	-	-	-	-	-	-
3866	Washer 3/16	-	-	-	2	-	-	-	-	-	-
7003	Nut No. 10-32	-	-	-	4	-	-	-	-	-	-
241119	Electrical-dome light	-	1	1	-	1	1	1	-	-	-
241119	Electrical-dome light front (With partition for 1113-33)	1	1	-	1	-	-	-	-	-	-
325683	Electrical-dome light rear (With partition for 1113-33)	1	1	-	1	-	-	-	-	-	-
102585	Electrical-dome light bulb (Mazda No. 81) 6 C.P.--(6 volt)	3	2	1	3	1	1	1	-	-	-
327566	Electrical-dome light bulb (Mazda No. 89) 6 C.P.--(12 volt)	3	1	1	3	1	1	1	-	-	-
220761	Electrical-dome light door switch	2	2	2	2	2	2	2	-	-	-
241135	Electrical-dome light glass and rim	2	2	1	2	1	1	1	-	-	-
242225	Electrical-dome light (front) instrument board switch (2 point) (With partition for 1113-33) (Supersedes 240390)	1	1	-	1	-	-	-	-	-	-
240391	Electrical-dome light (rear) instrument board switch (3 point) (With partition for 1113-33)	1	1	-	-	-	-	-	-	-	-
235175	Electrical-dome light reflector (2 sockets) (With partition for 1113-33)	1	1	-	1	-	-	-	-	-	-
235161	Electrical-dome light reflector (1 socket) .	1	1	1	1	1	1	1	-	-	-

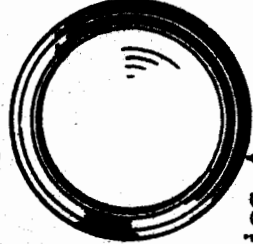
	220761		240390 240391		15th Series Only		136593		235846 235842
	↑ 15th Series Only		235796		235797		235175		15th Series Only
	183836		235423		224265		199891 241248		229866-241246
	241135		241119 325683		15th Series Only		199892-241247-Complete		

Piece No.	Name	(16th Series)									
		1112-1132 5 P. Formal Sedan	1103-13-33 5 P. Tour. Sedan	1114-34 7 P. Tour. Sedan	1115-35 7 P. Tour. Sedan Lim.	1116-36 5 P. Club Sedan	1117-37 5 P. Coupe	1118-38 2-4 P. Coupe	1119-39 2-4 P. Conv. Coupe	1143-53 5 P. Conv. Sedan	1107-27 5 P. Victoria
		No. Required									
235842	Electrical-dome light switch (3 point)	1	1	1	2	1	1	1	-	-	-
241310	Electrical-dome light switch plate	1	1	1	2	1	1	1	-	-	-
107654	Electrical-rear compartment light discon- nector plug socket	-	-	-	-	-	-	-	-	-	1
5984	Screw No. 6 x 3/8 rnd. hd. (Parker Kalon)	-	-	-	-	-	-	-	-	-	2
136593	Electrical-rear compartment light switch (2 point)	-	-	-	-	-	-	-	-	-	1
218105	Screw No. 4 x 5/8 oval hd. (Parker Kalon)	-	-	-	-	-	-	-	-	-	2
33287	Electrical-rear compartment light to switch cable assembly terminal 13/64 eye	-	-	-	-	-	-	-	-	-	1
235796	Electrical-rear quarter light (Used on 1112- 32-33-34-35-36-37)	2	2	2	2	2	2	-	-	-	-
5868	Screw No. 10-32 x 5/8 flat hd. (Used on 1112-32-33-34-35-36-37)	2	2	2	2	2	2	-	-	-	-
102590	Electrical-rear quarter light bulb 6 volt 3 C.P. G-6 single contact (Used on 1112- 32-33-34-35-36-37)	2	2	2	2	2	2	-	-	-	-
327565	Electrical-rear quarter light bulb 3 C.P. 12 volt	2	2	2	2	2	2	-	-	-	-
235797	Electrical-rear quarter light glass and rim (Used on 1112-32-33-34-35-36-37)	2	2	2	2	2	2	-	-	-	-
183836	Electrical-rear quarter light reflector (Used on 1112-32-23-33-34-35-36-37)	2	2	2	2	2	2	-	-	-	-
235846	Electrical-rear quarter light switch (2 point) (Used on 1112-32-33-34-35-36-37)	1	1	1	1	1	1	-	-	-	-
241118	Electrical-rear quarter light switch plate (Used on 1112-32-33-34-35-36-37)	1	1	1	1	1	1	-	-	-	-
102590	Electrical-rumble seat compartment light bulb 6 volt single contact 3 C.P.	-	-	-	-	-	-	1	1	-	-
327565	Electrical-rumble seat compartment light bulb 3 C.P.--12 volt	-	-	-	-	-	-	1	1	-	-
107654	Electrical-rumble seat compartment light disconnecter plug socket	-	-	-	-	-	-	1	1	-	-
136593	Electrical-rumble seat compartment light switch (2 point)	-	-	-	-	-	-	1	1	-	-
220761	Electrical-running board light door switch (Used on 1127-1139)	-	-	-	-	-	-	-	2	-	2
6567	Electrical-running board light door switch operative screw No. 10 x 5/7 binding hd. . (Parker Kalon) Type Z (Used on 1139-27) ..	-	-	-	-	-	-	-	x	-	x
240635	Electrical-running board light to switch cable assembly connector tip--male (Used on 1139-27)	-	-	-	-	-	-	-	2	-	2
171863	Electrical smoking case cigar lighter to ground cable clip	2	2	2	2	2	-	-	-	-	-
33287	Electrical smoking case cigar lighter to ground cable terminal	-	-	-	-	-	-	-	-	1	-
235796	Electrical tonneau light	-	-	-	-	-	-	-	-	1	-
5868	Screw No. 10-32 x 5/8 flat hd.	-	-	-	-	-	-	-	-	1	-
235797	Electrical tonneau light glass and rim	-	-	-	-	-	-	-	-	1	-
102590	Electrical tonneau light bulb	-	-	-	-	-	-	-	-	1	-
240635	Electrical tonneau light to door switch cable connector tip--male (Used on 1143) .	-	-	-	-	-	-	-	-	2	-
220761	Electrical tonneau light door switch	-	-	-	-	-	-	-	-	2	-

Piece No.	Name	(16th Series)										
		1112-1132 5 P. Formal Sedan	1103-1333 5 P. Tour. Sedan	1114-34 7 P. Tour. Sedan	1115-35 7 P. Tour. Sedan Lim.	1116-36 5 P. Club Sedan	1117-37 5 P. Coupe	1118-38 2-4 P. Coupe	1119-39 2-4 P. Conv. Coupe	1143-33 5 P. Conv. Sedan	1107-27 5 P. Victoria	
		No. Required										
197493	Screw No. 6-32 x 1/4 oval hd.	-	-	-	-	-	-	-	-	-	4	-
229433	Electrical tonneau light door switch operating screw No. 10 x 1/4 binding hd. (Parker Kalon) Type Z	-	-	-	-	-	-	-	-	-	x	-
33287	Electrical tonneau light to ground cable terminal 13/64	-	-	-	-	-	-	-	-	-	1	-
5676	Screw No. 10-32 x 3/8 rnd. hd.	-	-	-	-	-	-	-	-	-	1	-
183836	Electrical tonneau light reflector	-	-	-	-	-	-	-	-	-	1	-
102590	Electrical-vanity cabinet light bulb 7 volt single contact (Used on 1132)	2	-	-	-	-	-	-	-	-	-	-
107654	Electrical-vanity cabinet light discon- nector plug socket (Used on 1132)	2	-	-	-	-	-	-	-	-	-	-

FLOOR

231711	Floor-battery cover assembly	1	1	1	1	1	1	1	1	1	1	1
231713	Floor-battery cover fastener	1	1	1	1	1	1	1	1	1	1	1
305880	Floor-battery cover fastener rivet	1	1	1	1	1	1	1	1	1	1	1
231687	Floor-battery cover fastener striker plate .	1	1	1	1	1	1	1	1	1	1	1
231715	Floor-battery cover weatherstrip	1	1	1	1	1	1	1	1	1	1	1
231818	Floor-board (front) assembly (Used on 1112- 1103-13-14-15-16-17-18-19-1143-07)	1	1	1	1	1	1	1	1	1	1	1
235354	Floor-board (front) assembly (Used on 1132- 33-34-35-36-37-38-39-1153-27)	1	1	1	1	1	1	1	1	1	1	1
231632	Floor-board (rear) assembly	1	1	1	1	-	-	-	-	-	1	-
185832	Floor-board (front) washer	4	4	4	4	4	4	4	4	4	4	4
7906	Screw 1/4-28 x 3/4 rnd. hd.	2	2	2	2	2	2	2	2	2	2	2
5502	Lockwasher 1/4	2	2	2	2	2	2	2	2	2	2	2
5580	Floor-board to cross sill screw No. 10-32 x 1 flat hd.	-	-	-	-	-	-	-	2	2	-	-
5500	Lockwasher No. 10	-	-	-	-	-	-	-	2	2	-	-
7003	Nut No. 10-32	-	-	-	-	-	-	-	2	2	-	-
220771	Floor-board (front) felt front	1	1	1	1	1	1	1	1	1	1	1
220773	Floor-board (front) felt rear	1	1	1	1	1	1	1	1	1	1	1
220772	Floor-board (front) felt side	2	2	2	2	2	2	2	2	2	2	2
48317	Rivet	28	28	28	28	28	28	28	28	28	28	28
235355	Floor-board (front) hole cover assembly	1	1	1	1	1	1	1	1	1	1	1
231631	Floor-board (rear) cutout plate	1	1	1	1	1	1	1	1	1	1	1
231526	Floor-door scuff plate front lower--right (Used on 1103-1116)	-	1	-	-	1	-	-	-	-	-	-
231527	Floor-door scuff plate front lower--left (Used on 1103-1116)	-	1	-	-	1	-	-	-	-	-	-
231740	Floor-door scuff plate front lower--right (Used on 1112-13-14-15-1143-1107)	1	1	1	1	-	-	-	-	-	1	1
231741	Floor-door scuff plate front lower--left (Used on 1112-13-14-15-1143-07)	1	1	1	1	-	-	-	-	-	1	1
231736	Floor-door scuff plate front lower--right (Used on 1117-1118)	-	-	-	-	-	1	1	-	-	-	-
231737	Floor-door scuff plate front lower--left (Used on 1117-18)	-	-	-	-	-	1	1	-	-	-	-
231742	Floor-door scuff plate front lower--right (Used on 1132-33-34-35-1119-39-37-1153) ..	1	1	1	1	-	-	-	-	1	1	1
231743	Floor-door scuff plate front lower--left (Used on 1132-33-34-35-1119-39-27-1153) ..	1	1	1	1	-	-	-	-	1	1	1



241111



15th Series
Only

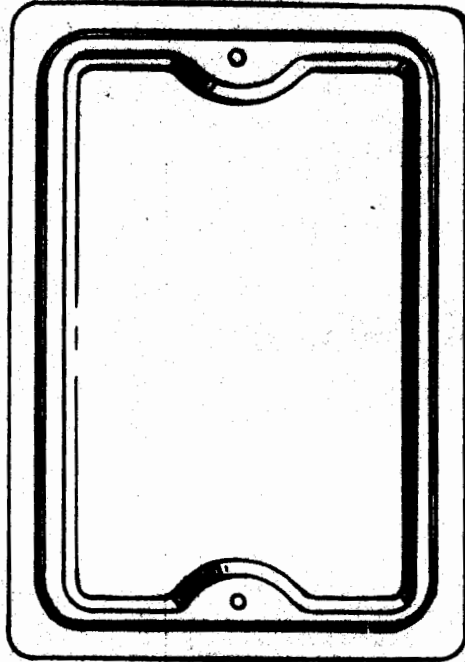

231711



185114

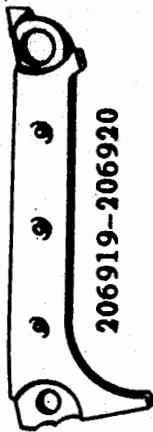

206919-206920

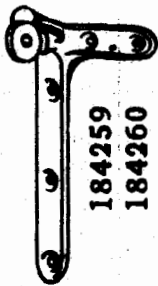

184259
184260

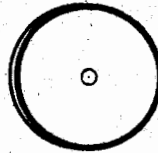

235355



100100



224286-224287
224305-6-7 -8

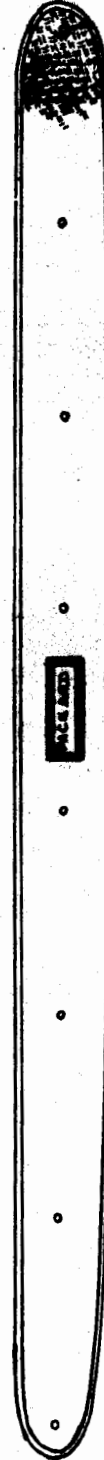

231526-27 - 231740-41-42-43-46-47--231736-37-38-39

(16th Series)

Piece No.	Name											No. Required	
		1112-1132 S P. Formal Sedan	1103-1133 S P. Tour. Sedan	1114-34 7 P. Tour. Sedan	1115-35 7 P. Tour. Sedan Lim.	1116-36 S P. Club Sedan	1117-37 S P. Coupe	1118-38 2-4 P. Coupe	1119-39 2-4 P. Conv. Coupe	1143-53 S P. Conv. Sedan	1107-27 S P. Victoria		
231746	Floor-door scuff plate front lower--right (Used on 1136)	-	-	-	-	1	-	-	-	-	-	-	-
231747	Floor-door scuff plate front lower--left (Used on 1136)	-	-	-	-	1	-	-	-	-	-	-	-
231738	Floor-door scuff plate front lower--right (Used on 1137-38)	-	-	-	-	-	1	1	-	-	-	-	-
231739	Floor-door scuff plate front lower--left (Used on 1137-38)	-	-	-	-	-	1	1	-	-	-	-	-
231528	Floor-door scuff plate front upper--right (Used on 1103-1116-36)	-	1	-	-	1	-	-	-	-	-	-	-
231529	Floor-door scuff plate front upper--left (Used on 1103-1116-36)	-	1	-	-	1	-	-	-	-	-	-	-
231744	Floor-door scuff plate front upper--right (Used on 1112-32-13-33-14-34-15-35-17-37- 18-38)	1	1	1	1	-	1	1	-	-	-	-	-
231745	Floor-door scuff plate front upper--left (Used on 1112-32-13-33-14-34-15-35-17-37- 18-38)	1	1	1	1	-	1	1	-	-	-	-	-
236026	Floor-door scuff plate front upper--right ..	-	-	-	-	-	-	-	1	-	-	-	1
236686	Floor-door scuff plate front upper--right ..	-	-	-	-	-	-	-	-	-	1	-	-
236027	Floor-door scuff plate front upper--left ...	-	-	-	-	-	-	-	1	-	-	-	1
236687	Floor-door scuff plate front upper--left ...	-	-	-	-	-	-	-	-	1	-	-	-
224286	Floor-door scuff plate rear lower (Used on 1112-1103-1113)	2	2	-	-	-	-	-	-	-	-	-	-
224287	Floor-door scuff plate rear lower (Used on 1132-1133)	2	2	-	-	-	-	-	-	-	-	-	-
224305	Floor-door scuff plate rear lower--right (Used on 1114-15-16-1143)	-	-	1	1	1	-	-	-	-	1	-	-
224306	Floor-door scuff plate rear lower--left (Used on 1114-15-16-1143)	-	-	1	1	1	-	-	-	-	1	-	-
224307	Floor-door scuff plate rear lower--right (Used on 1134-35-36-1153)	-	-	1	1	1	-	-	-	-	1	-	-
224308	Floor-door scuff plate rear lower--left (Used on 1134-35-36-1153)	-	-	1	1	1	-	-	-	-	1	-	-
224403	Floor-door scuff plate rear upper--right (Used on 1103)	-	1	-	-	-	-	-	-	-	-	-	-
224404	Floor-door scuff plate rear upper--left (Used on 1103)	-	1	-	-	-	-	-	-	-	-	-	-
226262	Floor-door scuff plate rear upper--right (Used on 1112-32-1113-33)	1	1	-	-	-	-	-	-	-	-	-	-
226261	Floor-door scuff plate rear upper--left (Used on 1112-32-1113-33)	1	1	-	-	-	-	-	-	-	-	-	-
224407	Floor-door scuff plate rear upper--right ...	-	-	1	1	1	-	-	-	-	-	-	-
227738	Floor-door scuff plate rear upper--right ...	-	-	-	-	-	-	-	-	-	1	-	-
224408	Floor-door scuff plate rear upper--left	-	-	1	1	1	-	-	-	-	-	-	-
227739	Floor-door scuff plate rear upper--left	-	-	-	-	-	-	-	-	-	1	-	-
6595	Screw No. 6 x 7/8 oval hd. (Parker Kalon--Type A)	-	-	-	-	-	-	-	-	-	42	56	42
231635	Floor-rear seat pan and side sill assembly .	1	1	1	1	-	-	-	-	-	-	-	-
241309	Floor-rear seat pan and side sill assembly .	-	-	-	-	-	-	-	-	-	-	1	-
231758	Floor-rear seat pan and side sill assembly .	-	-	-	-	1	-	-	-	-	-	-	-
235061	Floor-rear seat pan and side sill assembly .	-	-	-	-	-	1	-	-	-	-	-	-
241311	Floor-rear seat pan and side sill assembly .	-	-	-	-	-	-	-	-	-	-	-	1
231756	Floor-rear seat pan and side sill assembly .	-	-	-	-	-	-	1	1	-	-	-	-

Piece No.	(16th Series) Name	No. Required									
		1112-1132 5 P. Formal Sedan	1103-13-33 5 P. Tour. Sedan	1114-34 7 P. Tour. Sedan	1115-35 7 P. Tour. Sedan Lim.	1116-36 5 P. Club Sedan	1117-37 5 P. Coupe	1118-38 2-4 P. Coupe	1119-39 2-4 P. Conv. Coupe	1143-43 5 P. Conv. Sedan	1107-27 5 P. Victoria

FOLDING SEAT

Always send samples of material when ordering trimmed assemblies, as the assemblies are upholstered to match the body interior.

233757	Folding seat trimmed assembly (Used on 1114)	-	-	2	-	-	-	-	-	-	-	-	-	-	-	-	-	-	-	-
233113	Folding seat trimmed assembly (Used on 1134)	-	-	2	-	-	-	-	-	-	-	-	-	-	-	-	-	-	-	-
233756	Folding seat trimmed assembly (Used on 1115)	-	-	-	2	-	-	-	-	-	-	-	-	-	-	-	-	-	-	-
233387	Folding seat trimmed assembly (Used on 1135)	-	-	-	2	-	-	-	-	-	-	-	-	-	-	-	-	-	-	-
226263	Folding seat trimmed assembly	1	-	-	-	-	-	-	-	-	-	-	-	-	-	-	-	-	-	-
184270	Folding seat untrimmed assembly	1	1	-	-	-	-	-	-	-	-	-	-	-	-	-	-	-	-	-
224065	Folding seat untrimmed assembly	-	-	2	2	-	-	-	-	-	-	-	-	-	-	-	-	-	-	-
224154	Folding seat back untrimmed assembly	-	-	2	2	-	-	-	-	-	-	-	-	-	-	-	-	-	-	-
184853	Folding seat back untrimmed assembly	1	1	-	-	-	-	-	-	-	-	-	-	-	-	-	-	-	-	-
184260	Folding seat back bracket--right	1	1	-	-	-	-	-	-	-	-	-	-	-	-	-	-	-	-	-
184259	Folding seat back bracket--left	1	1	-	-	-	-	-	-	-	-	-	-	-	-	-	-	-	-	-
184866	Screw 1/4-28 x 1-1/8 flat hd.	2	2	-	-	-	-	-	-	-	-	-	-	-	-	-	-	-	-	-
7004	Nut 1/4-28	2	2	-	-	-	-	-	-	-	-	-	-	-	-	-	-	-	-	-
185113	Folding seat back to seat frame screw	-	-	4	4	-	-	-	-	-	-	-	-	-	-	-	-	-	-	-
184268	Folding seat back to seat frame screw	2	2	-	-	-	-	-	-	-	-	-	-	-	-	-	-	-	-	-
184682	Folding seat cushion pad	1	1	-	-	-	-	-	-	-	-	-	-	-	-	-	-	-	-	-
233798	Folding seat cushion pad	-	-	2	-	-	-	-	-	-	-	-	-	-	-	-	-	-	-	-
172294	Folding seat cushion spring	-	-	-	2	-	-	-	-	-	-	-	-	-	-	-	-	-	-	-
231991	Folding seat floor plate assembly	-	-	1	1	-	-	-	-	-	-	-	-	-	-	-	-	-	-	-
224064	Folding seat frame assembly	-	-	2	2	-	-	-	-	-	-	-	-	-	-	-	-	-	-	-
5580	Screw No. 10-32 x 1 flat hd.	-	-	16	16	-	-	-	-	-	-	-	-	-	-	-	-	-	-	-
5229	Screw 1/4-28 x 1-3/8 flat hd.	-	-	8	8	-	-	-	-	-	-	-	-	-	-	-	-	-	-	-
8220	Screw 1/4-28 x 1-1/2 flat hd.	-	-	8	8	-	-	-	-	-	-	-	-	-	-	-	-	-	-	-
7003	Nut No. 10-32	-	-	16	16	-	-	-	-	-	-	-	-	-	-	-	-	-	-	-
7004	Nut 1/4-28	-	-	16	16	-	-	-	-	-	-	-	-	-	-	-	-	-	-	-
3867	Washer 3/16 special	-	-	4	4	-	-	-	-	-	-	-	-	-	-	-	-	-	-	-
185118	Folding seat frame side--right	-	-	2	2	-	-	-	-	-	-	-	-	-	-	-	-	-	-	-
185111	Folding seat frame side--left	-	-	2	2	-	-	-	-	-	-	-	-	-	-	-	-	-	-	-
241111	Folding seat handle	1	1	2	2	-	-	-	-	-	-	-	-	-	-	-	-	-	-	-
100100	Folding seat pivot pin	-	-	4	4	-	-	-	-	-	-	-	-	-	-	-	-	-	-	-
184851	Folding seat support right assembly	1	1	-	-	-	-	-	-	-	-	-	-	-	-	-	-	-	-	-
184852	Folding seat support left assembly	1	1	-	-	-	-	-	-	-	-	-	-	-	-	-	-	-	-	-
206920	Folding seat support--right	-	-	2	2	-	-	-	-	-	-	-	-	-	-	-	-	-	-	-
206919	Folding seat support--left	-	-	2	2	-	-	-	-	-	-	-	-	-	-	-	-	-	-	-
185114	Folding seat support to seat frame screw ...	-	-	4	4	-	-	-	-	-	-	-	-	-	-	-	-	-	-	-
7006	Nut 3/8-24	-	-	4	4	-	-	-	-	-	-	-	-	-	-	-	-	-	-	-
5506	Lockwasher 3/8	-	-	4	4	-	-	-	-	-	-	-	-	-	-	-	-	-	-	-

FOOT REST

206140	Foot rest assembly (Specify set number) (Used on 1133-34-35)	-	1	1	1	-	-	-	-	-	-	-	-	-	-	-	-	-	-	-
212655	Foot rest assembly (Specify set number) (Used on 1103-13-14-15-43)	-	1	1	1	-	-	-	-	-	-	1	1	-	-	-	-	-	-	-
79574	Foot rest assembly	-	-	-	-	-	-	-	-	-	-	1	1	-	-	-	-	-	-	-
206134	Foot rest bar cushion (Used on 1133-34-35) .	-	1	1	1	-	-	-	-	-	-	-	-	-	-	-	-	-	-	-
206090	Foot rest bar end bracket--right (Used on 1133-34-35)	-	1	1	1	-	-	-	-	-	-	-	-	-	-	-	-	-	-	-

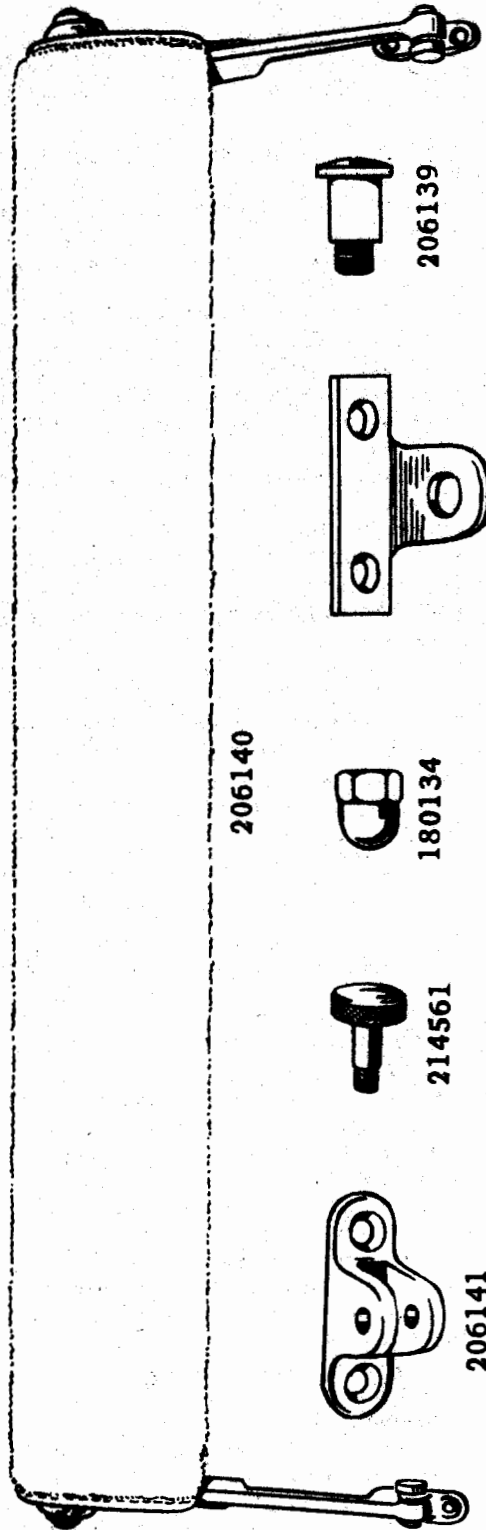
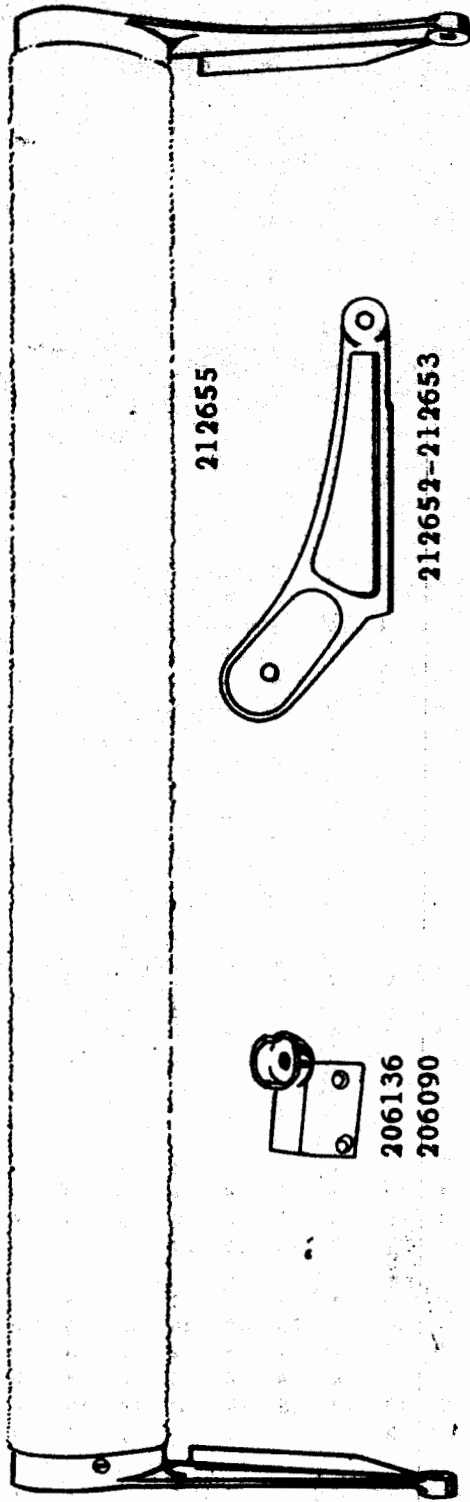

Piece No.	Name (16th Series)	No. Required									
		1112-1132 5 P. Formal Sedan	1103-13-33 5 P. Tour. Sedan	1114-34 7 P. Tour. Sedan	1119-35 7 P. Tour. Sedan Lim.	1116-36 5 P. Club Sedan	1117-37 5 P. Coupe	1118-38 2-4 P. Coupe	1119-39 2-4 P. Conv. Coupe	1143-53 5 P. Conv. Sedan	1107-37 5 P. Victoria
206136	Foot rest bar end bracket--left (Used on 1133-34-35)	-	1	1	1	-	-	-	-	-	-
206139	Foot rest bar end to support screw (Used on 1133-34-35)	-	2	2	2	-	-	-	-	-	-
195201	Foot rest bar end to support screw washer (Used on 1133-34-35)	-	2	2	2	-	-	-	-	-	-
6048	Lockwasher 3/8 (Shakeproof) (Used on 1133-34-35)	-	2	2	2	-	-	-	-	-	-
122146	Foot rest pivot stud	-	-	-	-	-	-	2	2	-	-
180134	Foot rest pivot stud nut--blind	-	-	-	-	-	-	2	2	-	-
212652	Foot rest support--right (Used on 1103-13-14-15-1143)	-	1	1	1	-	-	-	-	1	-
212653	Foot rest support--left (Used on 1103-13-14-15-1143)	-	1	1	1	-	-	-	-	1	-
6878	Screw No. 10-32 x 1-3/4 oval hd.....	-	-	-	-	-	-	-	-	2	-
206141	Foot rest support bracket (Used on 1133-34-35)	-	2	2	2	-	-	-	-	-	-
212656	Foot rest support bracket (Used on 1103-13-14-15-1143)	-	2	2	2	-	-	-	-	2	-
147114	Foot rest support bracket	-	-	-	-	-	-	2	2	-	-
8013	Screw No. 10-32 x 1-1/8 O.H.	-	4	4	4	-	-	-	-	2	-
214561	Foot rest to support bracket screw	-	2	2	2	-	-	-	-	-	-
206130	Foot rest support bracket cushion (Not used on 1153)	-	2	2	2	-	-	-	-	2	-
206132	Foot rest support cushion (Used on 1133-34-35)	-	2	2	2	-	-	-	-	-	-

FRONT END

224150	Front end-body to frame bolt bracket--liner 2 x 13-1/2	2	2	2	2	2	2	2	2	2	2
235680	Front end-panel assembly	-	1	1	1	1	1	1	-	-	-
235681	Front end-panel assembly	-	-	-	-	-	-	-	1	1	1
235679	Front end-panel assembly	1	-	-	-	-	-	-	-	-	-
231660	Front end-toe board bracket and support plate assembly--right	1	1	1	1	1	1	1	1	1	1
231661	Front end-toe board bracket and support plate assembly--left	1	1	1	1	1	1	1	1	1	1
6523	Bolt 1/4-28 x 3-5/8 carriage	4	4	4	4	4	4	4	4	4	4
6125	Bolt 5/16-24 x 2 step head	6	6	6	6	6	6	6	6	6	6
5449	Screw 5/16-24 x 3/4 hex. hd.	12	12	12	12	12	12	12	12	12	12
228237	Front end-toe board bracket and support plate assembly screw 5/16-24 x 2 flat hd..	4	4	4	4	4	4	4	4	4	4
7005	Nut 5/16-24	20	20	20	20	20	20	20	20	20	20
7004	Nut 1/4-28	4	4	4	4	4	4	4	4	4	4
5502	Lockwasher 1/4	4	4	4	4	4	4	4	4	4	4
5504	Lockwasher 5/16	18	18	18	18	18	18	18	18	18	18
6070	Lockwasher 5/16 (Shakeproof) (Woodtype)	2	2	2	2	2	2	2	2	2	2
236980	Front end-windshield header finishing moulding	-	-	-	-	-	-	-	1	1	1
6762	Screw No. 4 x 3/8 flat hd. (Phillips sheet metal)	-	-	-	-	-	-	-	23	23	23

Piece No.	Name	(16th Series)									
		1112-1122 5 P. Formal Sedan	1103-13-33 5 P. Tour. Sedan	1114-34 7 P. Tour. Sedan	1118-35 7 P. Tour. Sedan Lim.	1116-36 5 P. Club Sedan	1117-37 5 P. Coupe	1118-38 2-4 P. Coupe	1118-39 2-4 P. Conv. Coupe	1143-53 5 P. Conv. Sedan	1107-27 5 P. Victoria
		No. Required									
FRONT SEAT											
6229	Front seat assembly to track screw 5/16-18 x 1/2 hex. hd.	-	4	4	-	4	4	-	-	-	4
5504	Lockwasher 5/16	-	4	4	-	4	4	-	-	-	4
243364	Front seat back compartment lid trimmed assy.	-	-	-	-	-	-	-	-	-	-
226491	Front seat back compartment lid trimmed assy.	-	-	-	-	-	-	1	-	-	1
227900	Front seat back compartment lid hinge	-	-	-	-	-	-	-	-	-	3
227899	Front seat back compartment lid lock and striker	-	-	-	-	-	-	-	-	-	1
235880	Front seat back frame hinge—center right ..	-	-	-	-	-	1	-	-	-	1
235881	Front seat back frame hinge—center left ...	-	-	-	-	-	1	-	-	-	1
325508	Front seat back frame hinge—side right	-	-	-	-	-	1	-	-	-	1
325509	Front seat back frame hinge—side left	-	-	-	-	-	1	-	-	-	1
325512	Front seat back frame hinge bracket—center.	-	-	-	-	-	1	-	-	-	1
325511	Front seat back frame hinge bracket—side lt.	-	-	-	-	-	1	-	-	-	1
325510	Front seat back frame hinge bracket—side rt.	-	-	-	-	-	1	-	-	-	1
310404	Front seat back pivot screw—center	-	-	-	-	-	1	-	-	-	1
325766	Front seat back pivot screw—side	-	-	-	-	-	2	-	-	-	2
6044	Lockwasher 5/16 (Shakeproof)	-	-	-	-	-	2	-	-	-	2
310405	Front seat back pivot screw nut	-	-	-	-	-	1	-	-	-	1
325767	Front seat back pivot screw spacer—side ...	-	-	-	-	-	2	-	-	-	2
6614	Washer—center 7/16	-	-	-	-	-	1	-	-	-	1
241041	Front seat back spring	-	-	-	1	-	-	-	-	-	-
241044	Front seat back spring (With partition for 1113-33)	1	1	-	-	-	-	-	-	-	-
235740	Front seat back spring	-	1	1	-	1	-	-	-	-	-
241072	Front seat (right) back spring	-	-	-	-	-	1	-	-	-	-
241073	Front seat (left) back spring	-	-	-	-	-	1	-	-	-	-
241081	Front seat (left) back spring (L.H. drive) .	-	-	-	-	-	-	1	-	-	-
241080	Front seat (right) back spring (L.H. drive).	-	-	-	-	-	-	1	-	-	-
235972	Front seat (right) back spring (L.H. drive).	-	-	-	-	-	-	-	1	-	-
235973	Front seat (left) back spring (L.H. drive) .	-	-	-	-	-	-	-	1	-	-
236784	Front seat (right) back spring (L.H. drive).	-	-	-	-	-	-	-	-	1	-
241272	Front seat (right) back spring	-	-	-	-	-	-	-	-	-	1
236785	Front seat (left) back spring (L.H. drive) .	-	-	-	-	-	-	-	-	1	-
241273	Front seat (left) back spring	-	-	-	-	-	-	-	-	-	1
241090	Front seat (right) back spring (Used on 1118) (R.H. drive)	-	-	-	-	-	-	1	-	-	-
241302	Front seat (right) back spring (Used on 1143) (R.H. drive)	-	-	-	-	-	-	-	-	1	-
241092	Front seat (right) back spring (Used on 1119) (R.H. drive)	-	-	-	-	-	-	-	1	-	-
241303	Front seat (left) back spring (Used on 1143) (R.H. drive)	-	-	-	-	-	-	-	-	1	-
241091	Front seat (left) back spring (Used on 1118) (R.H. drive)	-	-	-	-	-	-	1	-	-	-
241093	Front seat (left) back spring (Used on 1119) (R.H. drive)	-	-	-	-	-	-	-	1	-	-
307189	Front seat back spring attaching screw No. 10 x 3/4 binding hd. (Parker Kalon) ..	-	2	2	-	2	2	-	-	-	2
5818	Lockwasher No. 10 (Shakeproof)	-	2	2	-	2	2	-	-	-	2
31338	Ferrule No. 10	-	-	-	-	-	2	-	-	-	2
314759	Screw No. 10 x 1-1/2 Type A (Parker Kalon)	-	-	-	-	-	2	-	-	-	2

Piece No.	(16th Series) Name	No. Required									
		1112-1132 5 P. Personal Sedan	1103-1133 5 P. Tour. Sedan	1114-34 7 P. Tour. Sedan	1115-35 7 P. Tour. Sedan Lim.	1116-36 5 P. Club Sedan	1117-37 5 P. Coupe	1118-38 2-4 P. Coupe	1119-39 2-4 P. Conv. Coupe	1143-53 5 P. Conv. Sedan	1107-27 5 P. Victoria
224566	Front seat (left) back valance rod (L.H. drive)	-	-	-	-	-	-	1	1	-	-
236057	Front seat (left) back valance rod (L.H. drive)	-	-	-	-	-	-	-	-	1	-
226353	Front seat (right) back valance rod (Used on 1118-19) (R.H. drive)	-	-	-	-	-	-	1	1	-	-
236736	Front seat (right) back valance rod (Used on 1143) (R.H. drive)	-	-	-	-	-	-	-	-	1	-
212683	Front seat (left) back valance rod bracket	-	-	-	-	-	-	1	1	1	-
<p>Always send samples of material when ordering cushion assemblies, as the assemblies are upholstered to match the body interior.</p>											
233681	Front seat cushion (trimmed) assembly (Used on 1112) (With partition for 1113)	1	1	-	-	-	-	-	-	-	-
233042	Front seat cushion (trimmed) assembly (Used on 1132) (With partition for 1133)	1	1	-	-	-	-	-	-	-	-
233682	Front seat cushion (trimmed) assembly (Used on 1115)	-	-	-	1	-	-	-	-	-	-
233043	Front seat cushion (trimmed) assembly (Used on 1135)	-	-	-	1	-	-	-	-	-	-
233680	Front seat cushion (trimmed) assembly (Used on 1103-13-14-16)	-	1	1	-	1	-	-	-	-	-
233683	Front seat cushion (trimmed) assembly (L.H. drive) (Used on 1117)	-	-	-	-	-	1	-	-	-	-
233841	Front seat cushion (trimmed) assembly (Used on 1133-34-36)	-	1	1	-	1	-	-	-	-	-
233846	Front seat cushion (trimmed) assembly (Used on 1137)	-	-	-	-	-	1	-	-	-	-
243197	Front seat cushion (trimmed) assembly (Used on 1107)	-	-	-	-	-	-	-	-	-	1
243179	Front seat cushion (trimmed) assembly (Used on 1127)	-	-	-	-	-	-	-	-	-	1
233708	Front seat cushion (trimmed) assembly (Used on 1117) (R.H. drive)	-	-	-	-	-	1	-	-	-	-
241103	Front seat (left) cushion (trimmed) assembly (Used on 1118) (R.H. drive)	-	-	-	-	-	-	1	-	-	-
241105	Front seat (left) cushion (trimmed) assembly (Used on 1119) (R.H. drive)	-	-	-	-	-	-	-	1	-	-
241102	Front seat (right) cushion (trimmed) assembly (Used on 1118) (R.H. drive)	-	-	-	-	-	-	1	-	-	-
241104	Front seat (right) cushion (trimmed) assembly (Used on 1119) (R.H. drive)	-	-	-	-	-	-	-	1	-	-
233049	Front seat (left) cushion (trimmed) assembly (Used on 1138)	-	-	-	-	-	-	1	-	-	-
233046	Front seat (left) cushion (trimmed) assembly (Used on 1139)	-	-	-	-	-	-	-	1	-	-
233685	Front seat (left) cushion (trimmed) assembly (L.H. drive) (Used on 1118)	-	-	-	-	-	-	1	-	-	-
233687	Front seat (left) cushion (trimmed) assembly (Used on 1119) (L.H. drive)	-	-	-	-	-	-	-	1	-	-
243109	Front seat (left) cushion (trimmed) assembly (Used on 1143)	-	-	-	-	-	-	-	-	1	-

Piece No.	Name	(16th Series)										
		1112-1132 5 P. Formal Sedan	1103-12-33 5 P. Tour. Sedan	1114-34 7 P. Tour. Sedan	1118-35 7 P. Tour. Sedan Lim.	1116-36 5 P. Club Sedan	1117-37 5 P. Coupe	1118-38 2-4 P. Coupe	1119-39 2-4 P. Conv. Coupe	1143-93 5 P. Conv. Sedan	1107-27 5 P. Victoria	
		No. Required										
243137	Front seat (left) cushion (trimmed) assembly (Used on 1153)	-	-	-	-	-	-	-	-	-	1	-
242108	Front seat (right) cushion (trimmed) assembly (Used on 1143)	-	-	-	-	-	-	-	-	-	1	-
243136	Front seat (right) cushion (trimmed) assembly (Used on 1153)	-	-	-	-	-	-	-	-	-	1	-
233048	Front seat (right) cushion (trimmed) assembly (Used on 1138)	-	-	-	-	-	-	1	-	-	-	-
233047	Front seat (right) cushion (trimmed) assembly (Used on 1139)	-	-	-	-	-	-	-	1	-	-	-
233684	Front seat (right) cushion (trimmed) assembly (Used on 1118) (L.H. drive)	-	-	-	-	-	-	1	-	-	-	-
233686	Front seat (right) cushion (trimmed) assembly (Used on 1119) (L.H. drive)	-	-	-	-	-	-	-	1	-	-	-
241040	Front seat cushion spring (With partition for 1113-33)	1	1	-	1	-	-	-	-	-	-	-
235741	Front seat cushion spring	-	1	1	-	1	-	-	-	-	-	-
241078	Front seat (right) cushion spring (L.H. drive)	-	-	-	-	-	-	1	-	-	-	-
236786	Front seat (right) cushion spring (L.H. drive)	-	-	-	-	-	-	-	-	-	1	-
235970	Front seat (right) cushion spring (L.H. drive)	-	-	-	-	-	-	-	-	1	-	-
235971	Front seat (left) cushion spring (L.H. drive)	-	-	-	-	-	-	-	-	1	-	-
236787	Front seat (left) cushion spring (L.H. drive)	-	-	-	-	-	-	-	-	-	1	-
241079	Front seat (left) cushion spring (L.H. drive)	-	-	-	-	-	-	1	-	-	-	-
241074	Front seat cushion spring (L.H. drive)	-	-	-	-	-	-	1	-	-	-	-
241274	Front seat cushion spring (L.H. drive)	-	-	-	-	-	-	-	-	-	-	1
241075	Front seat cushion spring (Used on 1117) (R.H. drive)	-	-	-	-	-	-	1	-	-	-	-
241282	Front seat cushion spring (Used on 1107) (R.H. drive)	-	-	-	-	-	-	-	-	-	-	1
241096	Front seat (right) cushion spring (Used on 1118) (R.H. drive)	-	-	-	-	-	-	-	1	-	-	-
241294	Front seat cushion spring--right (Used on 1143) (R.H. drive)	-	-	-	-	-	-	-	-	-	1	-
241098	Front seat (right) cushion spring (Used on 1119) (R.H. drive)	-	-	-	-	-	-	-	-	1	-	-
241097	Front seat (left) cushion spring (Used on 1118) (R.H. drive)	-	-	-	-	-	-	-	1	-	-	-
241295	Front seat (left) cushion spring (Used on 1143) (R.H. drive)	-	-	-	-	-	-	-	-	-	-	1
241099	Front seat (left) cushion spring (Used on 1119) (R.H. drive)	-	-	-	-	-	-	-	-	1	-	-
326058	Front seat operating button	-	-	-	-	-	-	1	-	-	-	1
325515	Front seat operating button and link assy.	-	-	-	-	-	-	1	-	-	-	1
318535	Front seat operating button and rod assy. 4280 Pin 1/16 x 1/2 spring cotter	-	1	1	-	1	-	-	-	-	-	-
224303	Front seat left operating button rod and cable assembly (L.H. drive)	-	-	-	-	-	-	-	-	1	-	-
226787	Front seat (left) operating button rod and cable assembly (L.H. drive)	-	-	-	-	-	-	-	-	1	-	-
227631	Front seat (left) operating button rod and cable assembly (L.H. drive)	-	-	-	-	-	-	-	-	-	1	-
226749	Front seat (right) operating button rod and cable assembly (Used on 1118) (R.H. drive)	-	-	-	-	-	-	-	1	-	-	-

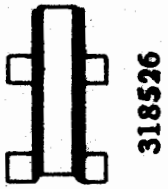

318526



0320707



15th Series



325515



326058



15th Series



327258



318535



15th Series

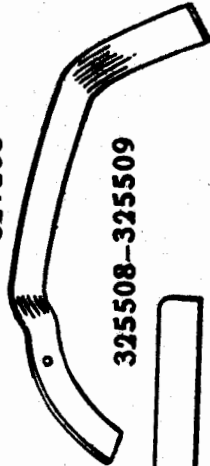

325508-325509



224303-226749-226787
226788-227631-227927



325510-11

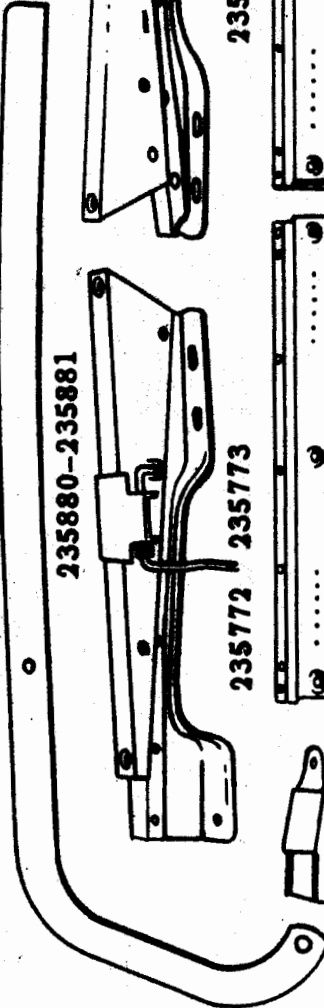

235880-235881



235808-235809

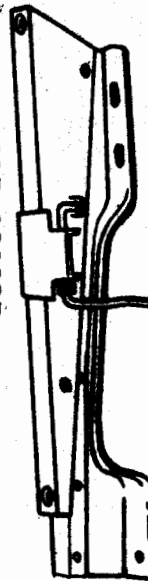

235772 235773

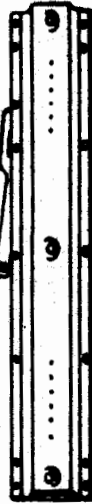

212849-212850



212848



325512



235340-235341

Piece No.	Name	(16th Series)										
		1112-1132 5 P. Formal Sedan	1103-13-33 5 P. Tour. Sedan	1114-34 7 P. Tour. Sedan	1115-35 7 P. Tour. Sedan Lim.	1116-36 5 P. Club Sedan	1117-37 5 P. Coupe	1118-38 2-4 P. Coupe	1119-39 2-4 P. Conv. Coupe	1143-53 5 P. Conv. Sedan	1107-27 5 P. Victoria	
		No. Required										
227927	Front seat (right) operating button rod and cable assembly (Used on 1143) (R.H. drive)	-	-	-	-	-	-	-	-	-	1	-
226788	Front seat (right) operating button rod and cable assembly (Used on 1119) (R.H. drive)	-	-	-	-	-	-	-	-	1	-	-
7901	Screw No. 10-32 x 5/8 round head	-	-	-	-	-	-	-	1	1	1	-
220797	Front seat (left) operating button finishing plate (L.H. drive)	-	-	-	-	-	-	-	1	1	1	-
226333	Front seat operating button finishing plate (Used on 1118-19-43) (R.H. drive)	-	-	-	-	-	-	-	1	1	1	-
325517	Front seat operating button finishing plate.	-	-	-	-	-	-	1	-	-	-	1
318533	Front seat operating button finishing plate.	-	1	1	-	1	-	-	-	-	-	-
308802	Front seat operating button finishing plate screw No. 6 x 3/8 binding hd. (Parker Kalon)	-	-	-	-	-	-	1	-	-	-	1
6766	Screw No. 6 x 7/8 oval hd. (Parker Kalon) (Phillips sheet metal)	-	2	2	-	2	-	-	-	-	-	-
325516	Front seat operating button link	-	-	-	-	-	-	1	-	-	-	1
4280	Cotter pin 1/16 x 1/2	-	-	-	-	-	-	1	-	-	-	1
310642	Front seat operating button pin	-	-	-	-	-	-	1	-	-	-	1
318526	Front seat operating button and rod shield	-	1	1	-	1	-	-	-	-	-	-
226527	Front seat (left) operating button spring (L.H. drive)	-	-	-	-	-	-	-	1	1	1	-
226544	Front seat (right) operating button spring (Used on 1118-19-43) (R.H. drive)	-	-	-	-	-	-	-	1	1	1	-
224302	Front seat (left) operating cable guide assy.	-	-	-	-	-	-	-	1	1	1	-
327258	Front seat operating spring	-	1	1	-	1	1	-	-	-	-	1
122611	Front seat package compartment lid hinge ...	-	-	-	-	-	-	-	3	-	-	-
220878	Front seat package compartment lid lock knob (cylinder locking type)	-	-	-	-	-	-	-	1	-	-	-
226361	Washer 3/4 plain special	-	-	-	-	-	-	-	1	-	-	-
220879	Nut 3/4-28 thread special	-	-	-	-	-	-	-	1	-	-	-
226722	Front seat package compartment lid lock striker plate	-	-	-	-	-	-	-	1	-	-	-
235809	Front seat support operating mechanism—left (Used on 1103-13-14-16-17-07) (R.H. drive)	-	1	1	-	1	1	-	-	-	-	1
235772	Front seat support operating mechanism—right (Used on 1103-13-14-16-17-07) (R.H. drive)	-	1	1	-	1	1	-	-	-	-	1
212850	Front seat (right) support operating mechanism—right (Used on 1118-19-43) (R.H. drive)	-	-	-	-	-	-	-	1	1	1	-
212848	Front seat (right) support operating mechanism—left (Used on 1118-19-43) (R.H. drive)	-	-	-	-	-	-	-	1	1	1	-
212848	Front seat (left) support operating mechanism—right (L.H. drive)	-	-	-	-	-	-	-	1	1	1	-
235773	Front seat support operating mechanism—left (L.H. drive)	-	1	1	-	1	1	-	-	-	-	1
235808	Front seat (left) support operating mechanism—right (L.H. drive)	-	1	1	-	1	1	-	-	-	-	1
212849	Front seat (left) support operating mechanism—left (L.H. drive)	-	-	-	-	-	-	-	1	1	1	-
5483	Screw 5/16-24 x 3/4 hex. hd.	-	2	2	-	2	2	-	-	-	-	2
7864	Screw 5/16-24 x 2-1/4 hex. hd.	-	-	-	-	-	-	-	1	1	1	-
7816	Screw 5/16-24 x 2-1/2 hex. hd.	-	-	-	-	-	-	-	1	1	1	-

Piece No.	(16th Series) Name											No. Required
		1112-1132 S P. Formal Sedan	1103-1133 S P. Tour. Sedan	1114-34 7 P. Tour. Sedan	1115-35 7 P. Tour. Sedan Lim.	1116-36 S P. Club Sedan	1117-37 S P. Coupe	1118-38 2-4 P. Coupe	1119-39 2-4 P. Conv. Coupe	1143-53 S P. Conv. Sedan	1107-27 S P. Victoria	
5909	Screw 5/16-24 x 1-1/2 hex. hd.	-	-	-	-	-	2	-	-	-	2	
5906	Screw 5/16-24 x 2-1/8 hex. hd.	-	2	2	-	2	-	-	-	-	-	
5907	Screw 5/16-24 x 1-3/4 hex. hd.	-	-	-	-	-	-	1	1	1	-	
5566	Screw 5/16-24 x 1-1/8 hex. hd.	-	-	-	-	-	-	1	1	1	-	
5324	Screw 5/16-24 x 3-1/2 hex. hd.	-	-	-	-	-	-	-	-	1	-	
6091	Screw 5/16-24 x 3 hex. hd.	-	-	-	-	-	-	-	-	1	-	
3909	Plain washer 5/16 special	-	-	-	-	-	-	2	2	4	-	
7005	Nut 5/16-24 standard	-	-	-	-	-	-	2	2	4	-	
5504	Lockwasher 5/16	-	4	4	-	4	4	4	4	4	4	
235340	Front seat support operating mechanism connecting shaft	-	1	1	-	1	-	-	-	-	-	
235341	Front seat support operating mechanism connecting shaft	-	-	-	-	-	1	-	-	-	1	
0320707	Front seat support operating mechanism side lock	-	1	1	-	1	1	-	-	-	-	

GOLF COMPARTMENT

224713	Golf compartment door hinge assembly	-	-	-	-	-	-	4	4	-	-
224704	Golf compartment door hinge seal	-	-	-	-	-	-	4	4	-	-
308425	Golf compartment door lock	-	-	-	-	-	-	2	2	-	-
308482	Golf compartment door lock cylinder lock ...	-	-	-	-	-	-	2	2	-	-
143615	Golf compartment door lock striker	-	-	-	-	-	-	2	2	-	-
224728	Golf compartment door panel--right	-	-	-	-	-	-	1	-	-	-
224729	Golf compartment door panel--left	-	-	-	-	-	-	1	-	-	-
228196	Golf compartment door panel--right	-	-	-	-	-	-	-	1	-	-
228197	Golf compartment door panel--left	-	-	-	-	-	-	-	1	-	-
228145	Golf compartment door weatherstrip	-	-	-	-	-	-	-	2	-	-
224705	Golf compartment door weatherstrip	-	-	-	-	-	-	2	-	-	-
224712	Golf compartment door weatherstrip retainer.	-	-	-	-	-	-	2	-	-	-
228147	Golf compartment door weatherstrip retainer.	-	-	-	-	-	-	-	2	-	-

HASSOCK

233571	Hassock assembly (Specify set number) (Used on 1112-1116 and with partition for 1113)	2	2	-	-	2	-	-	-	-	-
174216	Hassock assembly (Specify set number) (Used on 1132-1136 and with partition for 1133)	2	2	-	-	2	-	-	-	-	-
243413	Hassock assembly (Specify set number) (Used on 1153)	-	-	-	-	-	-	-	-	2	-

PARTITION

241111	Partition-back compartment lid handle	1	1	-	-	-	-	-	-	-	-
122611	Partition-back compartment lid hinge	2	2	-	-	-	-	-	-	-	-
105029	Partition-back compartment lid spring dowel.	1	1	-	-	-	-	-	-	-	-
229284	Partition-back compartment lid striker plate	1	1	-	-	-	-	-	-	-	-
224195	Partition-folding seat compartment panel assembly	-	-	-	1	-	-	-	-	-	-
226026	Partition-folding seat compartment panel assembly	1	1	-	-	-	-	-	-	-	-
8202	Screw 1/4-28 x 7/8 flat hd.	4	4	-	4	-	-	-	-	-	-
241110	Partition-header clock (Used on 1135)	-	-	-	1	-	-	-	-	-	-

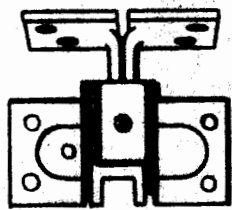

224713



310404



325767



318533

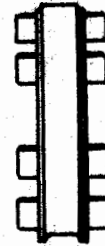

15th Series

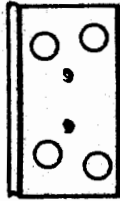

224704



325766



15th Series

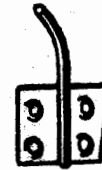

224302



143615



226544
226527



325517



220797
226333



308482

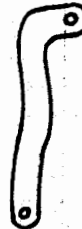

325516



310405



227899



308425

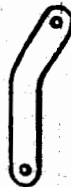

15th Series



226722

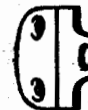

15th Series



227900

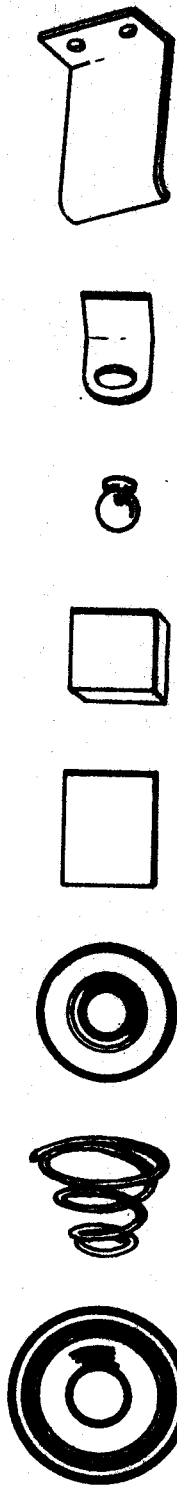

241115 133264 15th Series 199571 131316 241116 226025 243504

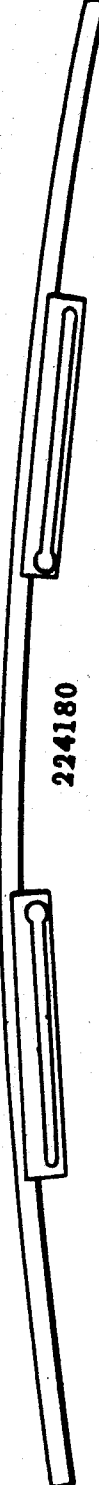

224180

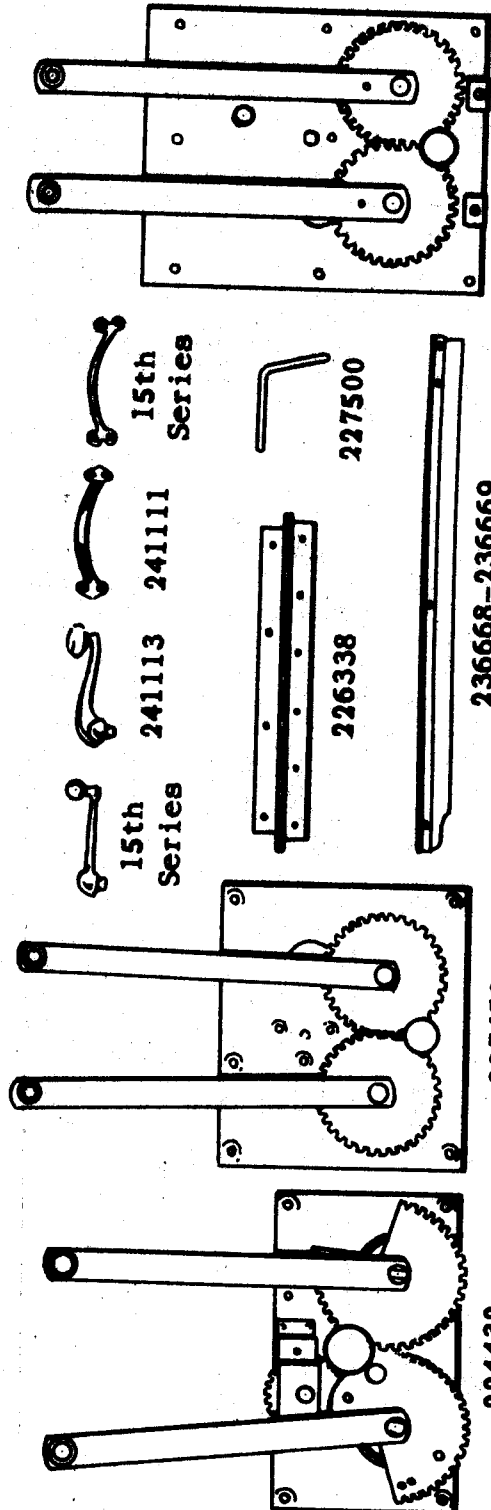

224957

227453

224432

15th Series
241113 241111

227500

226338

236668-236669



224824

Piece No.	Name	(16th Series)									
		1112-1132 S P. Formal Sedan	1103-13-33 S P. Tour. Sedan	1114-34 7 P. Tour. Sedan	1115-35 7 P. Tour. Sedan Lim.	1116-36 S P. Club Sedan	1117-37 S P. Coupe	1118-38 2-4 P. Coupe	1119-39 2-4 P. Conv. Coupe	1143-53 S P. Conv. Sedan	1107-27 S P. Victoria
		No. Required									
226789	Partition-header liner	1	1	-	-	-	-	-	-	-	-
228051	Partition-regulator handle compartment lid trimmed assembly (With partition for 1113-33)	1	1	-	-	-	-	-	-	-	-
226338	Partition-regulator handle compartment lid hinge	1	1	-	-	-	-	-	-	-	-
6193	Rivet 1/8 x 3/16 countersunk hd.	6	6	-	-	-	-	-	-	-	-
241116	Partition-regulator handle compartment lid knob	1	1	-	-	-	-	-	-	-	-
5497	Machine screw No. 10-32 x 1/2 oval hd..	1	1	-	-	-	-	-	-	-	-
164239	Ferrule No. 10	1	1	-	-	-	-	-	-	-	-
226025	Partition-regulator handle compartment lid striker plate	2	2	-	-	-	-	-	-	-	-
105029	Partition-regulator handle compt. lid dowel.	2	2	-	-	-	-	-	-	-	-
224214	Partition-window anti-rattler front	-	-	-	3	-	-	-	-	-	-
199571	Partition-window anti-rattler rear	-	-	-	2	-	-	-	-	-	-
243502	Partition-window division channel--right ...	-	-	-	-	-	-	-	-	1	-
243503	Partition-window division channel--left	-	-	-	-	-	-	-	-	1	-
6159	Screw No. 8-32	-	-	-	-	-	-	-	-	4	-
235942	Partition-window finishing moulding assembly (Used on 1115) (Antiqua Tan)	-	-	-	1	-	-	-	-	-	-
224176	Partition-window finishing moulding assembly (Used on 1115) (Walnut)	-	-	-	1	-	-	-	-	-	-
231770	Partition-window finishing moulding (Used on 1135)	-	-	-	1	-	-	-	-	-	-
236760	Partition-window finishing moulding--front center	-	-	-	-	-	-	-	-	1	-
236764	Partition-window finishing moulding--front side--right	-	-	-	-	-	-	-	-	1	-
236765	Partition-window finishing moulding--front side--left	-	-	-	-	-	-	-	-	1	-
236762	Partition-window finishing moulding--rear center	-	-	-	-	-	-	-	-	1	-
236767	Partition-window finishing moulding--rear side--right	-	-	-	-	-	-	-	-	1	-
236766	Partition-window finishing moulding--rear side--left	-	-	-	-	-	-	-	-	1	-
6792	Screw No. 6-40 x 1 oval hd.	-	-	-	-	-	-	-	-	10	-
235771	Partition-window finishing moulding ferrule No. 6	-	-	-	7	-	-	-	-	20	-
233719	Partition-window to folding top sponge rubber (3/4 x 7/8 x 60)	-	-	-	-	-	-	-	-	1	-
224936	Partition-window glass	1	1	-	-	-	-	-	-	-	-
227786	Partition-window glass--center	-	-	-	-	-	-	-	-	1	-
224129	Partition-window glass	-	-	-	1	-	-	-	-	-	-
236665	Partition-window glass--sides	-	-	-	-	-	-	-	-	2	-
143554	Partition-window glass cushion	1	1	-	-	-	-	-	-	-	-
243507	Partition-window glass and frame assembly ..	-	-	-	-	-	-	-	-	1	-
236668	Partition-window glass frame guide--right ..	-	-	-	-	-	-	-	-	1	-
236669	Partition-window glass frame guide--left ...	-	-	-	-	-	-	-	-	1	-
5254	Screw No. 8-32 x 5/16 oval hd.	-	-	-	-	-	-	-	-	4	-
243508	Partition-window glass frame assembly	-	-	-	-	-	-	-	-	1	-
243773	Partition-window glass frame bottom channel and lifter assembly	-	-	-	-	-	-	-	-	1	-
243505	Partition-window glass frame bottom channel bumper--long	-	-	-	-	-	-	-	-	1	-

Piece No.	(16th Series) Name	No. Required									
		1112-1132 S P. Formal Sedan	1103-13-33 S P. Tour. Sedan	1114-34 7 P. Tour. Sedan	1115-35 7 P. Tour. Sedan Lim.	1116-36 S P. Club Sedan	1117-37 S P. Coupe	1118-38 2-4 P. Coupe	1119-39 2-4 P. Conv. Coupe	1143-53 S P. Conv. Sedan	1107-27 S P. Victoria
243506	Partition-window glass frame bottom channel bumper—short	-	-	-	-	-	-	-	-	2	-
227500	Partition-window glass frame bottom corner bracket	-	-	-	-	-	-	-	-	2	-
6159	Screw No. 8-32 x 9/16 oval head	-	-	-	-	-	-	-	-	4	-
236671	Partition-window glass frame side channel ..	-	-	-	-	-	-	-	-	2	-
5310	Screw No. 8-32 x 1/4 rnd. hd.	-	-	-	-	-	-	-	-	4	-
5861	Washer No. 8 (Shakeproof)	-	-	-	-	-	-	-	-	4	-
243538	Partition-window glass frame side weatherstrip	-	-	-	-	-	-	-	-	2	-
236670	Partition-window glass frame top channel ...	-	-	-	-	-	-	-	-	1	-
243536	Partition-window glass frame upper center weatherstrip	-	-	-	-	-	-	-	-	1	-
243537	Partition-window glass frame upper end weatherstrip	-	-	-	-	-	-	-	-	1	-
224824	Partition-window lifter assembly	1	1	-	-	-	-	-	-	-	-
224180	Partition-window lifter assembly	-	-	-	1	-	-	-	-	-	-
224213	Partition-window lifter bumper	-	-	-	1	-	-	-	-	-	-
224432	Partition-window regulator assembly	-	-	-	1	-	-	-	-	-	-
227453	Partition-window regulator assembly	-	-	-	-	-	-	-	-	1	-
224957	Partition-window regulator assembly	1	1	-	-	-	-	-	-	-	-
243504	Partition-window regulator arm stop	-	-	-	-	-	-	-	-	2	-
241113	Partition-window regulator handle (tenite knob)	1	1	-	1	-	-	-	-	1	-
243880	Partition-window regulator handle (chrome knob)	1	1	-	1	-	-	-	-	1	-
241115	Partition-window regulator handle escutcheon plate	1	1	-	1	-	-	-	-	1	-
133264	Partition-window regulator handle escutcheon plate spring	1	1	-	1	-	-	-	-	1	-
133339	Partition-window regulator handle insert ...	1	1	-	1	-	-	-	-	1	-
132972	Partition-window regulator handle pin	1	1	-	1	-	-	-	-	1	-
224781	Partition-window runway	2	2	-	-	-	-	-	-	-	-
220696	Partition-window runway lower	-	-	-	2	-	-	-	-	-	-
227991	Partition-window runway lower	-	-	-	-	-	-	-	-	2	-
224227	Partition-window runway upper	-	-	-	1	-	-	-	-	-	-
227894	Partition-window runway upper	-	-	-	-	-	-	-	-	2	-
218826	Partition-window runway screw No. 6 x 1/2 oval hd. (Parker Kalon)	-	-	-	-	-	-	-	-	4	-
163168	Partition-window runway retainer	2	2	-	2	-	-	-	-	-	-
132429	Partition-window runway shim 1/16 x 1/2 x 40	x	x	-	x	-	-	-	-	-	-
136008	Partition-window runway shim 1/32 x 1/2 x 40	x	x	-	x	-	-	-	-	-	-
131316	Partition-window stop block bumper	2	2	-	-	-	-	-	-	-	-
331591	Partition-window regulator handle washer ...	1	1	-	1	-	-	-	-	1	-

REAR PILLAR

236974	Rear pillar finishing plate—right	-	-	-	-	-	-	-	-	-	1
236975	Rear pillar finishing plate—left	-	-	-	-	-	-	-	-	-	1
236730	Rear pillar finishing plate—right	-	-	-	-	-	-	-	-	1	-
236731	Rear pillar finishing plate—left	-	-	-	-	-	-	-	-	1	-
228055	Rear pillar finishing plate—right	-	-	-	-	-	-	-	1	-	-
228056	Rear pillar finishing plate—left	-	-	-	-	-	-	-	1	-	-
5766	Screw No. 6-40 x 3/8 oval hd.	-	-	-	-	-	-	-	8	-	-
6536	Screw No. 4-40 x 5/16 flat hd.	-	-	-	-	-	-	-	-	8	12

Piece No.	Name	(16th Series)									
		1112-1132 S P. Formal Sedan	1103-13-33 S P. Tour. Sedan	1114-34 7 P. Tour. Sedan	1119-35 7 P. Tour. Sedan Lim.	1116-36 S P. Club Sedan	1117-37 S P. Coupe	1118-38 2-4 P Coupe	1119-39 2-4 P. Coav. Coupe	1143-53 S P. Coav. Sedan	1107-27 S P. Victoria
		No. Required									
REAR QUARTER WINDOW											
224456	Rear quarter window curtain assembly--right (Used on 1103-13) (Furnish sample and set number)	-	1	-	-	-	-	-	-	-	-
224458	Rear quarter window curtain assembly--right (Used on 1133) (Furnish sample and set number)	-	1	-	-	-	-	-	-	-	-
224457	Rear quarter window curtain assembly--left (Used on 1103-13) (Furnish sample and set number)	-	1	-	-	-	-	-	-	-	-
224459	Rear quarter window curtain assembly--left (Used on 1133) (Furnish sample and set number)	-	1	-	-	-	-	-	-	-	-
224460	Rear quarter window curtain assembly--right (Used on 1114-15) (Furnish sample and set number)	-	-	1	1	-	-	-	-	-	-
224462	Rear quarter window curtain assembly--right (Used on 1134-35) (Furnish sample and set number)	-	-	1	1	-	-	-	-	-	-
224461	Rear quarter window curtain assembly--left (Used on 1114-15) (Furnish sample and set number)	-	-	1	1	-	-	-	-	-	-
224463	Rear quarter window curtain assembly--left (Used on 1134-35) (Furnish sample and set number)	-	-	1	1	-	-	-	-	-	-
226572	Rear quarter window curtain assembly--right (Used on 1117) (Furnish sample and set number)	-	-	-	-	-	1	-	-	-	-
226574	Rear quarter window curtain assembly--right (Used on 1137) (Furnish sample and set number)	-	-	-	-	-	1	-	-	-	-
226573	Rear quarter window curtain assembly--left (Used on 1117) (Furnish sample and set number)	-	-	-	-	-	1	-	-	-	-
226575	Rear quarter window curtain assembly--left (Used on 1137) (Furnish sample and set number)	-	-	-	-	-	1	-	-	-	-
224343	Rear quarter window curtain rod assembly ...	-	2	-	-	-	-	-	-	-	-
224237	Rear quarter window curtain rod assembly ...	-	-	2	2	-	-	-	-	-	-
226526	Rear quarter window curtain rod assembly ...	-	-	-	-	-	2	-	-	-	-
36111	Rear quarter window curtain rod anti-rattler	-	4	4	4	-	4	-	-	-	-
214901	Rear quarter window curtain rod screw eye ..	-	4	4	4	-	4	-	-	-	-
224392	Rear quarter window curtain roller--right ..	-	1	-	-	-	-	-	-	-	-
224411	Rear quarter window curtain roller--left ...	-	1	-	-	-	-	-	-	-	-
224230	Rear quarter window curtain roller--right ..	-	-	1	1	-	-	-	-	-	-
224342	Rear quarter window curtain roller--left ...	-	-	1	1	-	-	-	-	-	-
226517	Rear quarter window curtain roller--right ..	-	-	-	-	-	1	-	-	-	-
226516	Rear quarter window curtain roller--left ...	-	-	-	-	-	1	-	-	-	-
224115	Rear quarter window curtain roller bracket (female) right	-	1	1	1	-	1	-	-	-	-
224309	Rear quarter window curtain roller bracket (female) left	-	1	1	1	-	1	-	-	-	-
224137	Rear quarter window curtain roller bracket (male) assembly--right	-	1	1	1	-	-	-	-	-	-

Piece No.	(16th Series) Name	No. Required								
		1112-1132 5 P. Formal Sedan	1103-13-33 5 P. Tour. Sedan	1114-34 7 P. Tour. Sedan	1115-35 7 P. Tour. Sedan Lim.	1116-36 5 P. Club Sedan	1117-37 5 P. Coupe	1118-38 2-4 P. Coupe	1119-39 2-4 P. Conv. Coupe	1143-53 5 P. Conv. Sedan
224310	Rear quarter window curtain roller bracket (male) assembly--left	-	1	1	1	-	-	-	-	-
170966	Rear quarter window curtain tassel	-	2	2	2	-	2	-	-	-
226381	Rear quarter window drain gutter	-	-	-	-	-	2	-	-	-
229274	Rear quarter window drain pan assembly--rt..	-	1	1	1	-	-	-	-	-
229273	Rear quarter window drain pan assembly--lt..	-	1	1	1	-	-	-	-	-
308806	Rear quarter window drain pan tube hose	-	2	2	2	-	-	-	-	-
235940	Rear quarter window finishing moulding assembly--right (Used on 1103-13) (Antiqua Tan)	-	1	-	-	-	-	-	-	-
220680	Rear quarter window finishing moulding assembly--right (Used on 1103-13) (Walnut)	-	1	-	-	-	-	-	-	-
235941	Rear quarter window finishing moulding assembly--left (Used on 1103-13) (Antiqua Tan)	-	1	-	-	-	-	-	-	-
220679	Rear quarter window finishing moulding assembly--left (Used on 1103-13) (Walnut).	-	1	-	-	-	-	-	-	-
235938	Rear quarter window finishing moulding assembly--right (Used on 1114-15) (Antiqua Tan)	-	-	1	1	-	-	-	-	-
220674	Rear quarter window finishing moulding assembly--right (Used on 1114-15) (Walnut)	-	-	1	1	-	-	-	-	-
235939	Rear quarter window finishing moulding assembly--left (Used on 1114-15) (Antiqua Tan)	-	-	1	1	-	-	-	-	-
220675	Rear quarter window finishing moulding assembly--left (Used on 1114-15) (Walnut).	-	-	1	1	-	-	-	-	-
235936	Rear quarter window finishing moulding assembly--right (Used on 1117) (Antiqua Tan)	-	-	-	-	-	1	-	-	-
224695	Rear quarter window finishing moulding assembly--right (Used on 1117) (Walnut) ..	-	-	-	-	-	1	-	-	-
235937	Rear quarter window finishing moulding assembly--left (Used on 1117) (Antiqua Tan)	-	-	-	-	-	1	-	-	-
224696	Rear quarter window finishing moulding assembly--left (Used on 1117) (Walnut) ...	-	-	-	-	-	1	-	-	-
231760	Rear quarter window finishing moulding-- right (Used on 1133)	-	1	-	-	-	-	-	-	-
231761	Rear quarter window finishing moulding-- left (Used on 1133)	-	1	-	-	-	-	-	-	-
231620	Rear quarter window finishing moulding-- right (Used on 1134-35)	-	-	1	1	-	-	-	-	-
231621	Rear quarter window finishing moulding-- left (Used on 1134-35)	-	-	1	1	-	-	-	-	-
231768	Rear quarter window finishing moulding-- right (Used on 1137)	-	-	-	-	-	1	-	-	-
231769	Rear quarter window finishing moulding-- left (Used on 1137)	-	-	-	-	-	1	-	-	-
235771	Rear quarter window finishing moulding wood screw ferrule No. 6	-	8	8	8	-	8	-	-	-
226054	Rear quarter window glass	-	-	-	-	-	2	-	-	-
224852	Rear quarter window lifter assembly--right .	-	-	-	-	-	1	-	-	-
224853	Rear quarter window lifter assembly--left ..	-	-	-	-	-	1	-	-	-
226050	Rear quarter window lifter bumper	-	-	-	-	-	2	-	-	-
224806	Rear quarter window regulator assy.--right .	-	-	-	-	-	1	-	-	-

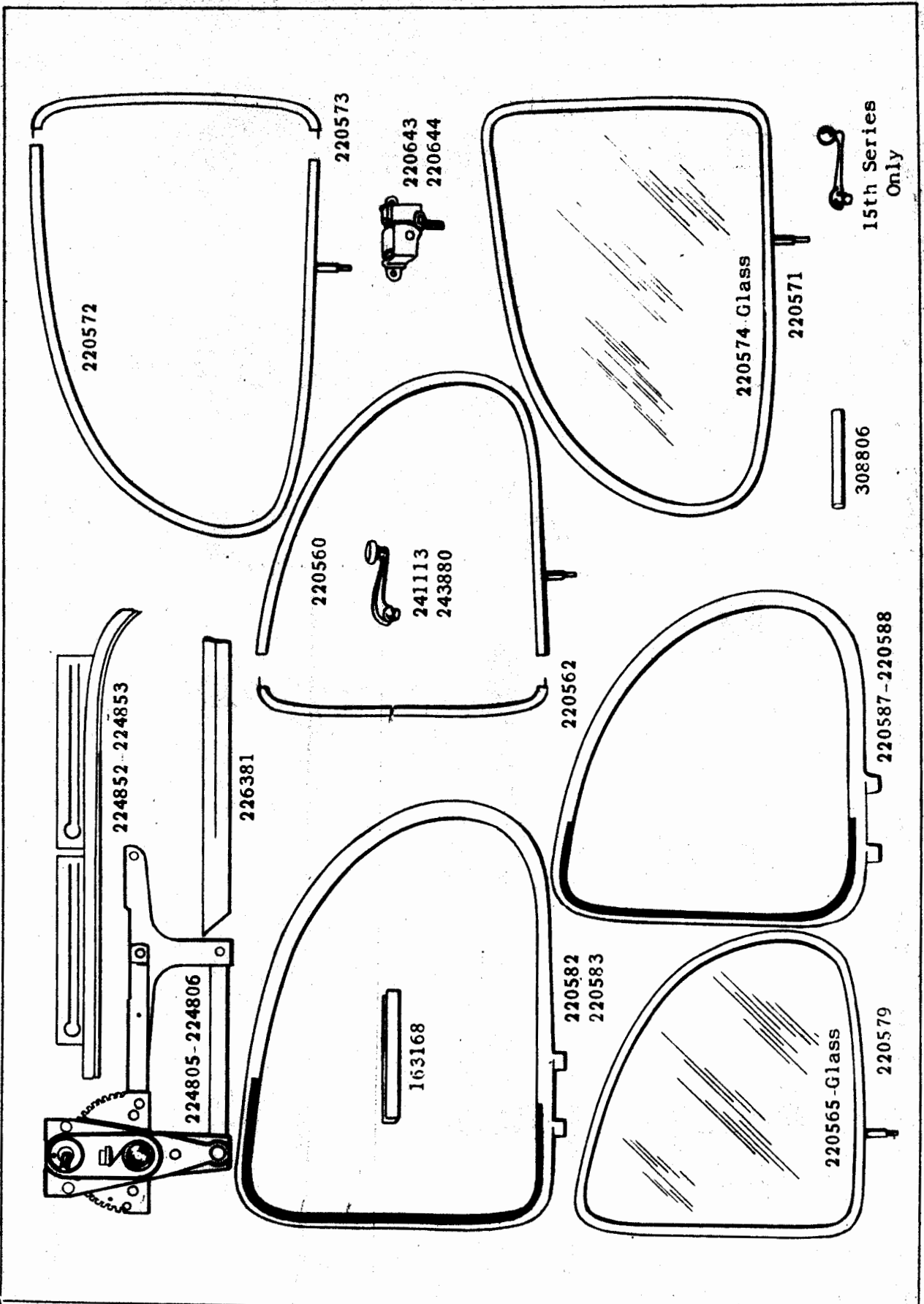

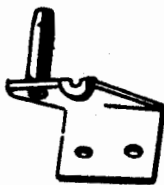

224137
224310



224309
224115

AWW

212490



229282



220576
220580



133264



170966



15th Series
Only



235848-241114
243894-243881



235854



235849



241115



15th Series
Only

Piece No.	Name	(16th Series)										No. Required
		1112-1132 5 P. Formal Sedan	1103-1333 5 P. Tour. Sedan	1114-34 7 P. Tour. Sedan	1115-35 7 P. Tour. Sedan Lim.	1116-36 5 P. Club Sedan	1117-37 5 P. Coupe	1118-38 2-4 P. Coupe	1119-39 2-4 P. Conv. Coupe	1143-53 5 P. Conv. Sedan	1107-27 5 P. Victoria	
224805	Rear quarter window regulator assy.—left ..	-	-	-	-	-	-	-	-	-	1	
8214	Screw 1/4-28 x 3/4 flat hd.	-	-	-	-	-	-	-	-	-	4	
8202	Screw 1/4-28 x 7/8 flat hd.	-	-	-	-	-	-	-	-	-	2	
241113	Rear quarter window regulator handle (tenite knob)	-	-	-	-	-	-	-	-	-	2	
243880	Rear quarter window regulator handle (chrome knob)	-	-	-	-	-	-	-	-	-	2	
241115	Rear quarter window regulator handle escutcheon plate	-	-	-	-	-	-	-	-	-	2	
133339	Rear quarter window regulator handle insert.	-	-	-	-	-	-	-	-	-	2	
132972	Rear quarter window regulator handle pin ...	-	-	-	-	-	-	-	-	-	2	
331591	Rear quarter window regulator handle washer.	-	-	-	-	-	-	-	-	-	2	
220695	Rear quarter window runway lower	-	-	-	-	-	-	-	-	-	4	
226056	Rear quarter window runway upper	-	-	-	-	-	-	-	-	-	2	
163168	Rear quarter window runway retainer	-	-	-	-	-	-	-	-	-	6	
136008	Rear quarter window runway shim 1/32 x 1/2 x 40"	-	-	-	-	-	-	-	-	-	X	
133429	Rear quarter window runway shim 1/16 x 1/2 x 40"	-	-	-	-	-	-	-	-	-	X	
220660	Rear quarter window wing assembly—right ...	-	1	-	-	-	-	-	-	-	-	
220661	Rear quarter window wing assembly—left	-	1	-	-	-	-	-	-	-	-	
220662	Rear quarter window wing assembly—right ...	-	-	1	1	-	-	-	-	-	-	
220663	Rear quarter window wing assembly—left	-	-	1	1	-	-	-	-	-	-	
220565	Rear quarter window wing glass	-	2	-	-	-	-	-	-	-	-	
220574	Rear quarter window wing glass	-	-	2	2	-	-	-	-	-	-	
220579	Rear quarter window wing glass and glass retainer assembly	-	2	-	-	-	-	-	-	-	-	
220571	Rear quarter window wing glass and glass retainer assembly	-	-	2	2	-	-	-	-	-	-	
228272	Rear quarter window wing glass cushion 1/16" thick	-	X	X	X	-	-	-	-	-	-	
229324	Rear quarter window wing glass cushion .080 x 1-1/2 everseal	-	X	X	X	-	-	-	-	-	-	
211649	Rear quarter window wing glass cushion 3/32 x 1-1/2 everseal	-	X	X	X	-	-	-	-	-	-	
220562	Rear quarter window wing glass retainer assembly—front	-	2	-	-	-	-	-	-	-	-	
220573	Rear quarter window wing glass retainer assembly—front	-	-	2	2	-	-	-	-	-	-	
220560	Rear quarter window wing glass retainer assembly—rear	-	2	-	-	-	-	-	-	-	-	
220572	Rear quarter window wing glass retainer assembly—rear	-	-	2	2	-	-	-	-	-	-	
212366	Rear quarter window wing glass retainer assembly—rear screw No. 4 x 3/16 (Parker Kalon)	-	4	4	4	-	-	-	-	-	-	
220600	Rear quarter window wing glass retainer pivot lower spacer	-	X	X	X	-	-	-	-	-	-	
212490	Rear quarter window wing glass retainer pivot upper spring	-	2	2	2	-	-	-	-	-	-	
220580	Rear quarter window wing glass retainer pivot upper spring plate	-	2	-	-	-	-	-	-	-	-	
220576	Rear quarter window wing glass retainer pivot upper spring plate	-	-	2	2	-	-	-	-	-	-	

Piece No.	(16th Series) Name	No. Required									
		1112-1132 5 P. Formal Sedan	1103-13-33 5 P. Tour. Sedan	1114-34 7 P. Tour. Sedan	1115-35 7 P. Tour. Sedan Lim.	1116-36 5 P. Club Sedan	1117-37 5 P. Coupe	1118-38 2-4 P. Coupe	1119-39 2-4 P. Conv. Coupe	1143-33 5 P. Conv. Sedan	1107-27 5 P. Victoria
140174	Rear quarter window wing glass retainer pivot upper spring plate screw No. 10-24 x 5/16 flat hd.	-	4	4	4	-	-	-	-	-	-
220643	Rear quarter window wing regulator assy.--rt.	-	1	1	1	-	-	-	-	-	-
220644	Rear quarter window wing regulator assy.--lt.	-	1	1	1	-	-	-	-	-	-
7837	Screw 1/4-20 x 7/8 hex. hd.	-	4	4	4	-	-	-	-	-	-
5502	Lockwasher 1/4	-	4	4	4	-	-	-	-	-	-
235848	Rear quarter window wing regulator handle (tenite knob) (Used on 1133-34-35)	-	2	2	2	-	-	-	-	-	-
241114	Rear quarter window wing regulator handle (tenite knob) (Used on 1103-13-14-15)	-	2	2	2	-	-	-	-	-	-
243894	Rear quarter window wing regulator handle (chrome knob) (Used on 1133-34-35)	-	2	2	2	-	-	-	-	-	-
243881	Rear quarter window wing regulator handle (chrome knob) (Used on 1103-13-14-15)	-	2	2	2	-	-	-	-	-	-
235854	Rear quarter window wing regulator handle escutcheon plate (Used on 1103-13-14-15)	-	2	2	2	-	-	-	-	-	-
235849	Rear quarter window wing regulator handle escutcheon plate (Used on 1133-34-35)	-	2	2	2	-	-	-	-	-	-
133264	Rear quarter window wing regulator handle escutcheon plate spring (Used on 1103- 13-14-15)	-	2	2	2	-	-	-	-	-	-
133339	Rear quarter window wing regulator handle insert	-	2	2	2	-	-	-	-	-	-
147910	Rear quarter window wing regulator handle screw (Used on 1133-34-35)	-	2	2	2	-	-	-	-	-	-
132972	Rear quarter window regulator handle pin (Used on 1103-13-14-15)	-	1	1	1	-	-	-	-	-	-
229282	Rear quarter window wing regulator shaft washer	-	2	2	2	-	-	-	-	-	-
220588	Rear quarter window wing weatherstrip assembly--right	-	1	-	-	-	-	-	-	-	-
220587	Rear quarter window wing weatherstrip assembly--left	-	1	-	-	-	-	-	-	-	-
220582	Rear quarter window wing weatherstrip assembly--right	-	-	1	1	-	-	-	-	-	-
220583	Rear quarter window wing weatherstrip assembly--left	-	-	1	1	-	-	-	-	-	-
220585	Rear quarter window wing weatherstrip retainer--left	-	1	-	-	-	-	-	-	-	-
220586	Rear quarter window wing weatherstrip retainer--right	-	1	-	-	-	-	-	-	-	-
220558	Rear quarter window wing weatherstrip retainer--right	-	-	1	1	-	-	-	-	-	-
220559	Rear quarter window wing weatherstrip retainer--left	-	-	1	1	-	-	-	-	-	-

REAR SEAT

241108	Rear seat adjusting handle	-	-	-	-	-	-	-	-	-	1
236773	Rear seat back frame hinge assembly	-	-	-	-	-	-	-	-	2	-
236029	Rear seat back hinge--female	-	-	-	-	-	-	-	-	-	2
236028	Rear seat back hinge--male	-	-	-	-	-	-	-	-	-	2
5827	Screw 1/4-28 x 1" flat hd.	-	-	-	-	-	-	-	-	-	27
7526	Rear seat back hinge clevis pin	-	-	-	-	-	-	-	-	-	2

Piece No.	Name	(16th Series)										
		1112-1132 5 P. Formal Sedan	1103-13-33 5 P. Tour. Sedan	1114-34 7 P. Tour. Sedan	1118-35 7 P. Tour. Sedan Lim.	1116-36 5 P. Club Sedan	1117-37 5 P. Coupe	1118-38 2-4 P. Coupe	1119-39 2-4 P. Conv. Coupe	1143-43 5 P. Conv. Sedan	1107-27 5 P. Victoria	
		No. Required										
4290	Rear seat back hinge cotter pin 3/32 x 5/8 .	-	-	-	-	-	-	-	-	-	-	2
236858	Rear seat back link to body bracket--right .	-	-	-	-	-	-	-	-	-	-	1
236859	Rear seat back link to body bracket--left .	-	-	-	-	-	-	-	-	-	-	1
227275	Rear seat back lock guide plate	-	-	-	-	-	-	-	-	-	-	1
227290	Rear seat back lock rod	-	-	-	-	-	-	-	-	-	-	1
227289	Rear seat back lock rod guide	-	-	-	-	-	-	-	-	-	-	1
243612	Rear seat back lock rod guide nut	-	-	-	-	-	-	-	-	-	-	1
3883	Washer 7/16" plain	-	-	-	-	-	-	-	-	-	-	1
5728	Lockwasher 7/16	-	-	-	-	-	-	-	-	-	-	1
62065	Washer 1/4" plain	-	-	-	-	-	-	-	-	-	-	1
4280	Cotter pin 1/16 x 1/2	-	-	-	-	-	-	-	-	-	-	1
227288	Rear seat back lock rod knob	-	-	-	-	-	-	-	-	-	-	1
227286	Rear seat back lock spring	-	-	-	-	-	-	-	-	-	-	1
227287	Rear seat back lock striker	-	-	-	-	-	-	-	-	-	-	1
235746	Rear seat back spring--right	1	1	1	1	-	-	-	-	-	-	1
236744	Rear seat back spring--right	-	-	-	-	-	-	-	-	-	-	1
224489	Rear seat back spring--right	-	-	-	-	1	-	-	-	-	-	-
224789	Rear seat back spring--right	-	-	-	-	-	1	-	-	-	-	-
236788	Rear seat back spring--right	-	-	-	-	-	-	-	-	-	-	1
235747	Rear seat back spring--left	1	1	1	1	-	-	-	-	-	-	-
236745	Rear seat back spring--left	-	-	-	-	-	-	-	-	-	-	1
224490	Rear seat back spring--left	-	-	-	-	1	-	-	-	-	-	-
224790	Rear seat back spring--left	-	-	-	-	-	1	-	-	-	-	-
236789	Rear seat back spring--left	-	-	-	-	-	-	-	-	-	-	1
227721	Rear seat back to trim frame rod and link assembly	-	-	-	-	-	-	-	-	-	-	1
241371	Rear seat back to trim frame link screw	-	-	-	-	-	-	-	-	-	-	2
243198	Rear seat cushion (trimmed) assembly (Used on 1107)	-	-	-	-	-	-	-	-	-	-	1
243180	Rear seat cushion (trimmed) assembly (Used on 1127)	-	-	-	-	-	-	-	-	-	-	1
243111	Rear seat cushion (trimmed) assembly (Used on 1143)	-	-	-	-	-	-	-	-	-	-	1
243139	Rear seat cushion (trimmed) assembly (Used on 1153)	-	-	-	-	-	-	-	-	-	-	1
233780	Rear seat cushion (trimmed) assembly (Used on 1112-1103-1113-14-1115)	1	1	1	1	-	-	-	-	-	-	-
233781	Rear seat cushion (trimmed) assembly (Used on 1116)	-	-	-	-	1	-	-	-	-	-	-
233782	Rear seat cushion (trimmed) assembly (Used on 1117)	-	-	-	-	-	1	-	-	-	-	-
233039	Rear seat cushion (trimmed) assembly (Used on 1132-33-34-35)	1	1	1	1	-	-	-	-	-	-	-
233040	Rear seat cushion (trimmed) assembly (Used on 1136)	-	-	-	-	1	-	-	-	-	-	-
233041	Rear seat cushion (trimmed) assembly (Used on 1137)	-	-	-	-	-	1	-	-	-	-	-
236177	Rear seat cushion dowel--female	-	-	-	-	-	-	-	-	-	-	4
224267	Rear seat cushion dowel--male	-	-	-	-	-	-	-	-	-	-	4
235748	Rear seat cushion spring	1	1	1	1	-	-	-	-	-	-	-
236748	Rear seat cushion spring	-	-	-	-	-	-	-	-	-	-	1
224488	Rear seat cushion spring	-	-	-	-	1	-	-	-	-	-	-
224794	Rear seat cushion spring	-	-	-	-	-	1	-	-	-	-	-
236783	Rear seat cushion spring	-	-	-	-	-	-	-	-	-	-	1
231551	Rear seat folding arm rest assembly-- untrimmed.....	1	1	1	1	1	-	-	-	-	-	-

Piece No.	Name (16th Series)	No. Required									
		1112-1132 5 P. Formal Sedan	1103-13-33 5 P. Tour. Sedan	1114-34 7 P. Tour. Sedan	1115-35 7 P. Tour. Sedan Lim.	1116-36 5 P. Club Sedan	1117-37 5 P. Coupe	1118-38 2-4 P. Coupe	1119-39 2-4 P. Conv. Coupe	1143-43 5 P. Conv. Sedan	1107-27 5 P. Victoria
231817	Rear seat folding arm rest assembly-- untrimmed	-	-	-	-	-	1	-	-	-	-
236985	Rear seat folding arm rest assembly-- untrimmed	-	-	-	-	-	-	-	1	-	-
235226	Rear seat folding arm rest assembly-- untrimmed	-	-	-	-	-	-	-	-	1	-
212602	Rear seat folding arm rest cushion	1	1	1	1	1	1	-	-	1	1
224082	Rear seat folding arm rest pivot screw	4	4	4	4	4	4	-	-	-	-
311143	Rear seat folding arm rest pivot screw	4	4	4	4	4	4	-	-	4	4
7837	Rear seat folding arm rest pivot screw 1/4-20 x 7/8 hex. hd.	-	-	-	-	-	-	-	-	4	4
62065	Washer 1/4	4	4	4	4	4	4	-	-	-	-
311144	Spacer	4	4	4	4	4	4	-	-	4	4
5502	Lockwasher 1/4	8	8	8	8	8	8	-	-	8	8
211648	Nut 1/4-28	8	8	8	8	8	8	-	-	4	4
211809	Spring washer	8	8	8	8	8	8	-	-	4	4
235960	Rear seat folding arm rest spring	1	1	1	1	1	-	-	-	-	-
236782	Rear seat folding arm rest spring	-	-	-	-	-	-	-	-	1	-
241076	Rear seat folding arm rest spring	-	-	-	-	-	1	-	-	-	-
236747	Rear seat folding arm rest spring	-	-	-	-	-	-	-	-	-	1

REAR VIEW MIRROR

235759	Rear view mirror	1	1	1	1	1	1	1	1	1	1
224332	Rear view mirror assembly screw No. 8-32 x 5/16 rnd. hd. special	2	2	2	2	2	2	2	2	2	2

REAR WINDOW

224214	Rear window anti-rattler (inside)	-	-	-	-	-	-	1	-	-	-
307006	Rear window anti-rattler (inside) screw No. 4 x 3/8 flat hd. (Parker Kalon) (Used on 1118)	-	-	-	-	-	-	1	-	-	-
224214	Rear window anti-rattler (outside)	-	-	-	-	-	-	1	-	-	-
228311	Rear window curtain assembly (Used on 1103- 13-14-15-16-17-18)	-	1	1	1	1	1	1	-	-	-
228313	Rear window curtain assembly (Used on 1112)	1	-	-	-	-	-	-	-	-	-
228314	Rear window curtain assembly (Used on 1132)	1	-	-	-	-	-	-	-	-	-
228312	Rear window curtain assembly (Used on 1133- 34-35-36-37-38)	-	1	1	1	1	1	1	-	-	-
226309	Rear window curtain finger pull	1	1	1	1	1	1	1	-	-	-
220984	Rear window curtain hook	1	1	1	1	1	1	1	-	-	-
220972	Rear window curtain rod assembly	-	1	1	1	1	1	1	-	-	-
226524	Rear window curtain rod assembly	1	-	-	-	-	-	-	-	-	-
228156	Rear window curtain roller assembly	1	-	-	-	-	-	-	-	-	-
228155	Rear window curtain roller assembly	-	1	1	1	1	1	1	-	-	-
228158	Rear window curtain roller bracket (female) ..	1	1	1	1	1	1	1	-	-	-
228157	Rear window curtain roller bracket (male) ..	1	1	1	1	1	1	1	-	-	-
220839	Rear window finishing moulding assembly (Walnut)	-	1	1	1	1	1	1	-	-	-
235886	Rear window finishing moulding (Used on 1112) (Antiqua Tan)	1	-	-	-	-	-	-	-	-	-
226901	Rear window finishing moulding (Walnut)	1	-	-	-	-	-	-	-	-	-



15th Series
Only



220984



133264



226309



15th Series
Only



228158



235847



228157



235849

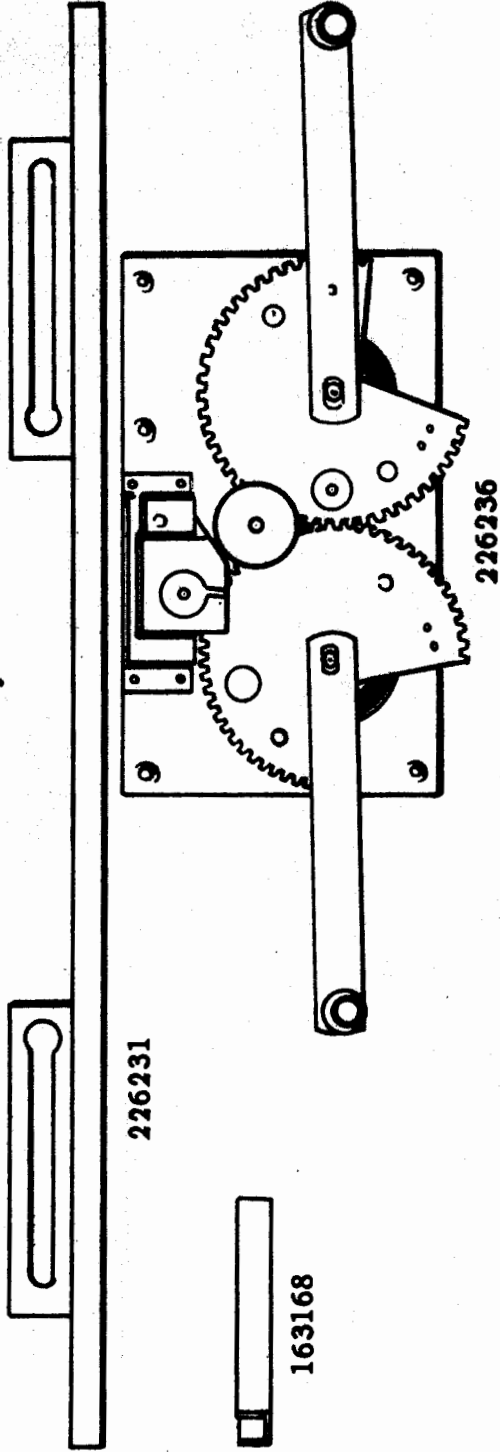



241123



15th Series Only



235841



187483

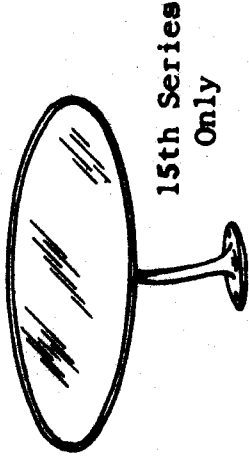

15th Series Only



235759



15th Series Only

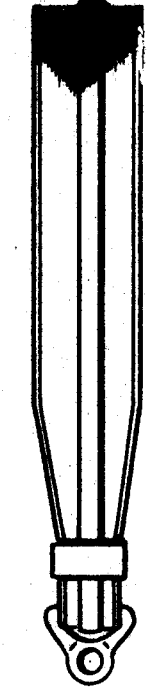

241120-241121



15th Series Only



235728
235729



235798-236988-Cord - 235799-241240-Complete

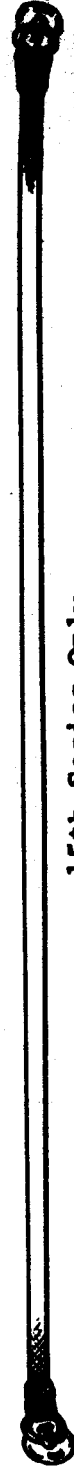

15th Series Only



314245



314246



314244



15th Series Only

Piece No.	Name	(16th Series)									
		1112-1132 5 P. Formal Sedan	1103-13-33 5 P. Tour. Sedan	1114-34 7 P. Tour. Sedan	1115-35 7 P. Tour. Sedan Lim.	1116-36 5 P. Club Sedan	1117-37 5 P. Coupe	1118-38 2-4 P. Coupe	1119-39 2-4 P. Conv. Coupe	1143-63 5 P. Conv. Sedan	1107-27 5 P. Victoria
		No. Required									
235889	Rear window finishing moulding assembly (Used on 1103-13-14-15-16-17) (Antiqua Tan)	-	1	1	1	1	1	-	-	-	-
226237	Rear window finishing moulding assembly (Walnut)	-	-	-	-	-	-	1	-	-	-
235931	Rear window finishing moulding assembly (Used on 1118) (Antiqua Tan)	-	-	-	-	-	-	1	-	-	-
6766	Screw No. 6 x 7/8 oval hd. (Phillips sheet metal)	-	4	4	4	4	4	-	-	-	-
235771	Rear window finishing moulding wood screw ferrule No. 6	4	4	4	4	4	4	4	-	-	-
220872	Rear window finishing rim	-	1	1	1	1	1	-	-	-	-
220924	Rear window glass	-	1	1	1	1	1	-	-	-	-
226057	Rear window glass	1	-	-	-	-	-	-	-	-	-
226223	Rear window glass	-	-	-	-	-	-	1	-	-	-
229808	Rear window glass cushion	-	1	1	1	1	1	-	-	-	-
226305	Rear window glass cushion	1	-	-	-	-	-	-	-	-	-
226203	Rear window glass retainer	1	-	-	-	-	-	-	-	-	-
229807	Rear window glass retainer	-	1	1	1	1	1	-	-	-	-
308802	Screw No. 6 x 3/8 binding hd. (Parker Kalon)	-	13	13	13	13	13	-	-	-	-
226231	Rear window lifter assembly	-	-	-	-	-	-	1	-	-	-
226235	Rear window lifter bumper	-	-	-	-	-	-	1	-	-	-
226236	Rear window regulator assembly	-	-	-	-	-	-	1	-	-	-
235847	Rear window regulator handle	-	-	-	-	-	-	1	-	-	-
235849	Rear window regulator handle escutcheon plate	-	-	-	-	-	-	1	-	-	-
133264	Rear window regulator handle escutcheon plate spring	-	-	-	-	-	-	1	-	-	-
133339	Rear window regulator handle insert	-	-	-	-	-	-	1	-	-	-
132972	Rear window regulator handle pin	-	-	-	-	-	-	1	-	-	-
331591	Rear window regulator handle washer	-	-	-	-	-	-	1	-	-	-
226274	Rear window runway lower	-	-	-	-	-	-	2	-	-	-
226273	Rear window runway upper	-	-	-	-	-	-	1	-	-	-
163168	Rear window runway retainer	-	-	-	-	-	-	2	-	-	-
136008	Rear window runway shim 1/32 x 1/2 x 40"	-	-	-	-	-	-	x	-	-	-
132429	Rear window runway shim 1/16 x 1/2 x 40"	-	-	-	-	-	-	x	-	-	-

ROBE RAIL

235799	Robe rail assembly	1	1	1	1	1	-	-	-	-	-
241240	Robe rail assembly	-	-	-	-	-	-	-	-	1	-
6824	Robe rail assembly screw No. 10-32 x 27/32 oval hd. (Phillips cone point)	4	4	4	4	4	-	-	-	4	-
235798	Robe rail cord assembly	1	1	1	1	1	-	-	-	-	-
236988	Robe rail cord assembly	-	-	-	-	-	-	-	-	1	-
314245	Robe rail end spring	2	2	2	2	2	-	-	-	2	-
314244	Robe rail end spring key	2	2	2	2	2	-	-	-	2	-
314246	Robe rail end spring sleeve	2	2	2	2	2	-	-	-	2	-

ROOF

220882	Roof joint moulding (93-1/2" long) (Used on 1103)	-	2	-	-	-	-	-	-	-	-
226002	Roof joint moulding (60" long)	1	-	-	-	-	-	-	-	-	-

Piece No.	Name (16th Series)											No. Required
		1112-1132 5 P. Formal Sedan	1103-13-33 5 P. Tour. Sedan	1114-34 7 P. Tour. Sedan	1115-35 7 P. Tour. Sedan Lim.	1116-36 5 P. Club Sedan	1117-37 5 P. Coupe	1118-38 2-4 P. Coupe	1119-39 2-4 P. Conv. Coupe	1143-53 5 P. Conv. Sedan	1107-27 5 P. Victoria	
226006	Roof joint moulding (100-1/2" long) (Used on 1113-1133)	-	-	2	-	-	-	-	-	-	-	-
220883	Roof joint moulding (105-1/2" long)	-	-	2	2	-	-	-	-	-	-	-
226005	Roof joint moulding (91-1/2" long)	-	-	-	-	2	-	-	-	-	-	-
226004	Roof joint moulding (82" long)	-	-	-	-	-	2	-	-	-	-	-
226003	Roof joint moulding (59-1/2" long)	-	-	-	-	-	-	2	-	-	-	-
235344	Roof-radio antenna lead in cable assembly	2	1	1	1	1	1	1	-	-	-	-
224948	Roof rain gutter moulding right (86" long)	1	-	-	-	-	-	-	-	-	-	-
235440	Roof rain gutter moulding--right (Used on 1103)	-	1	-	-	-	-	-	-	-	-	-
235442	Roof rain gutter moulding--right (Used on 1113-1133)	-	1	-	-	-	-	-	-	-	-	-
235444	Roof rain gutter moulding--right	-	-	1	1	-	-	-	-	-	-	-
235446	Roof rain gutter moulding--right	-	-	-	-	1	-	-	-	-	-	-
235448	Roof rain gutter moulding--right	-	-	-	-	-	1	-	-	-	-	-
235450	Roof rain gutter moulding--right	-	-	-	-	-	-	1	-	-	-	-
228329	Roof rain gutter moulding--left (86" long)	1	-	-	-	-	-	-	-	-	-	-
235441	Roof rain gutter moulding--left (Used on 1103)	-	1	-	-	-	-	-	-	-	-	-
235443	Roof rain gutter moulding--left (Used on 1113-1133)	-	1	-	-	-	-	-	-	-	-	-
235445	Roof rain gutter moulding--left	-	-	1	1	-	-	-	-	-	-	-
235447	Roof rain gutter moulding--left	-	-	-	-	1	-	-	-	-	-	-
235449	Roof rain gutter moulding--left	-	-	-	-	-	1	-	-	-	-	-
235451	Roof rain gutter moulding--left	-	-	-	-	-	-	1	-	-	-	-
235511	Roof rain gutter moulding screw No. 4 x 1/4 Asco flat hd. (self tapping)	-	x	x	x	x	x	x	-	-	-	-

RUMBLE SEAT

226335	Rumble seat back spring (Luxury type)	-	-	-	-	-	-	1	1	-	-	-
224718	Rumble seat compartment door hinge--right	-	-	-	-	-	-	1	1	-	-	-
224719	Rumble seat compartment door hinge--left	-	-	-	-	-	-	1	1	-	-	-
5909	Screw 5/16-24 x 1-1/2 hex. hd.	-	-	-	-	-	-	4	4	-	-	-
5504	Lockwasher 5/16	-	-	-	-	-	-	6	6	-	-	-
7005	Nut 5/16-24	-	-	-	-	-	-	2	2	-	-	-
6305	Stud 5/16	-	-	-	-	-	-	2	2	-	-	-
224716	Rumble seat compartment door hinge bracket--right	-	-	-	-	-	-	1	1	-	-	-
224717	Rumble seat compartment door hinge bracket--left	-	-	-	-	-	-	1	1	-	-	-
7613	Bolt 1/4-28 x 1-3/4 carriage	-	-	-	-	-	-	4	4	-	-	-
7004	Nut 1/4-28	-	-	-	-	-	-	4	4	-	-	-
5502	Lockwasher 1/4	-	-	-	-	-	-	4	4	-	-	-
8222	Screw 3/8-24 x 1 flat hd.	-	-	-	-	-	-	4	4	-	-	-
7006	Nut 3/8-24	-	-	-	-	-	-	4	4	-	-	-
5506	Lockwasher 3/8	-	-	-	-	-	-	4	4	-	-	-
127501	Rumble seat compartment door hinge bushing	-	-	-	-	-	-	2	2	-	-	-
127498	Rumble seat compartment door hinge screw	-	-	-	-	-	-	2	2	-	-	-
3884	Washer 1/2	-	-	-	-	-	-	2	2	-	-	-
5510	Lockwasher 1/2	-	-	-	-	-	-	2	2	-	-	-
157584	Rumble seat compartment door operating bolt	-	-	-	-	-	-	2	2	-	-	-
7104	Nut 1/4-28 castle	-	-	-	-	-	-	2	2	-	-	-
4280	Cotter pin 1/16 x 1/2	-	-	-	-	-	-	2	2	-	-	-

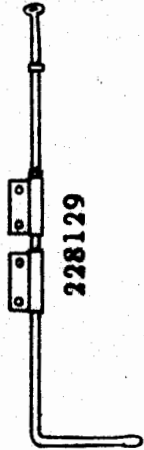
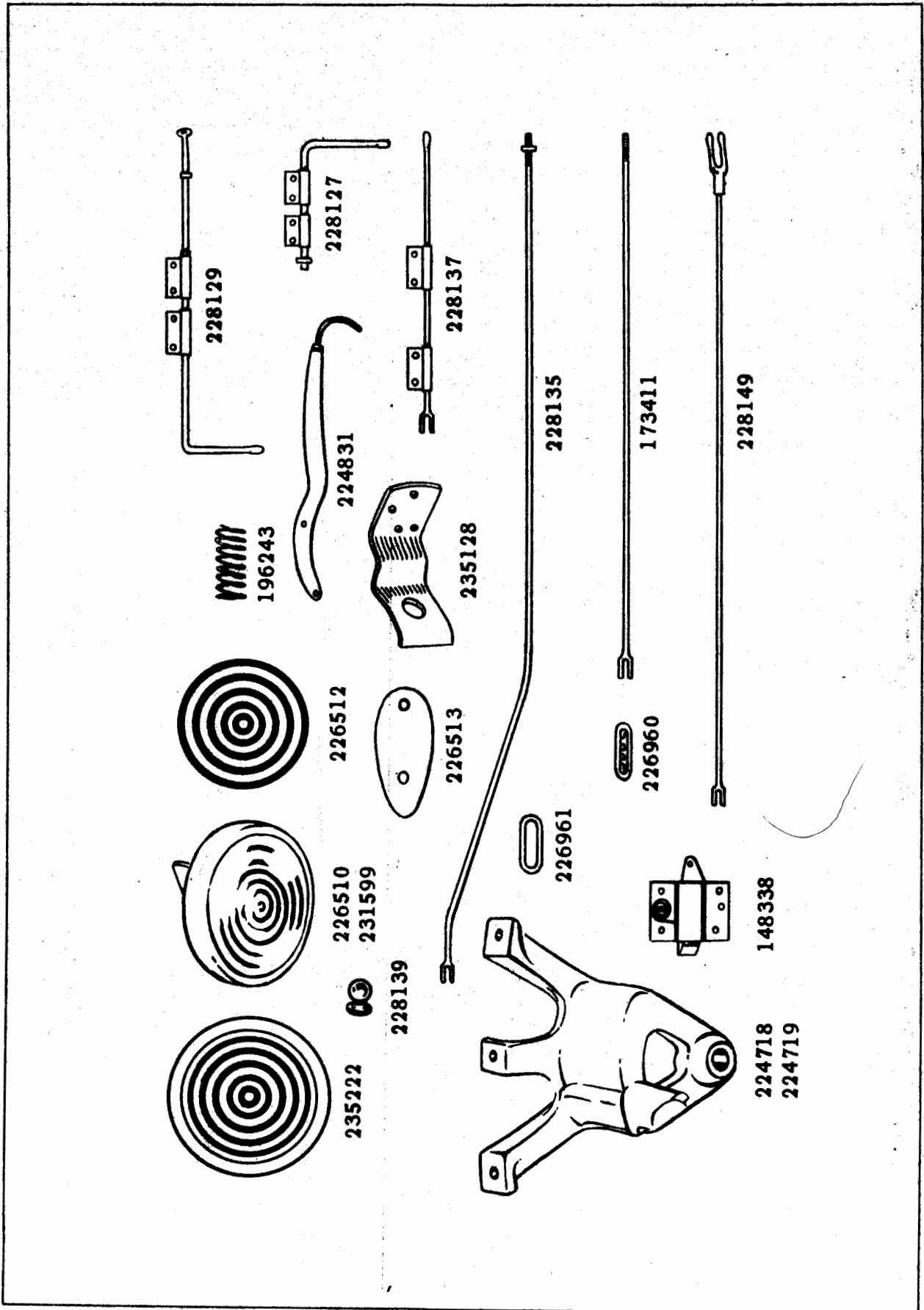

228129

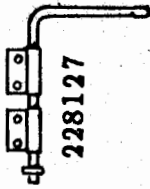

228127



228137



196243

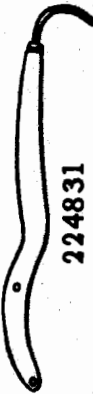

224831



235128



226512



226513



226510

231599



228139



235222

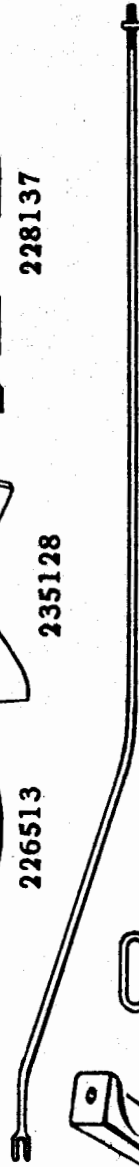

228135



226961



173411



226960



228149

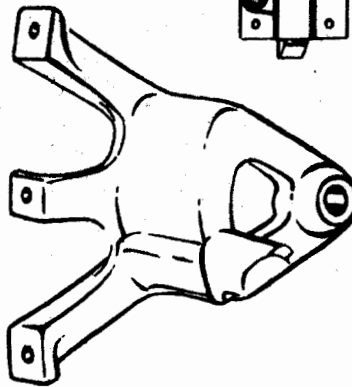

224718

224719

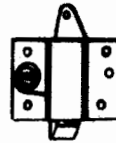

148338

Piece No.	Name	(16th Series)									
		1112-1132 5 P. Formal Sedan	1103-13-33 5 P. Tour. Sedan	1114-34 7 P. Tour. Sedan	1115-35 7 P. Tour. Sedan Lim.	1116-36 5 P. Club Sedan	1117-37 5 P. Coupe	1118-38 2-4 P. Coupe	1119-39 2-4 P. Conv. Coupe	1143-83 5 P. Conv. Sedan	1107-27 5 P. Victoria
		No. Required									
196243	Rumble seat compartment door operating spring	-	-	-	-	-	-	2	2	-	-
157585	Rumble seat compartment door operating spring washer	-	-	-	-	-	-	2	2	-	-
224715	Rumble seat compartment door panel	-	-	-	-	-	-	1	1	-	-
235348	Rumble seat compartment door weatherstrip ..	-	-	-	-	-	-	1	1	-	-
224961	Rumble seat compartment drain gutter assy. .	-	-	-	-	-	-	1	1	-	-
233528	Rumble seat cushion assembly	-	-	-	-	-	-	1	1	-	-
235279	Rumble seat cushion spring	-	-	-	-	-	-	1	1	-	-
148338	Rumble seat door lock	-	-	-	-	-	-	1	1	-	-
229393	Rumble seat door lock bolt weatherstrip	-	-	-	-	-	-	1	1	-	-
228127	Rumble seat door lock operating bell crank yoke and clip assembly—front	-	-	-	-	-	-	-	1	-	-
228129	Rumble seat door lock operating bell crank yoke and clip assembly—rear	-	-	-	-	-	-	-	1	-	-
229392	Rumble seat door lock operating bell crank clip	-	-	-	-	-	-	-	4	-	-
3907	Washer 1/4 plain	-	-	-	-	-	-	-	4	-	-
228139	Rumble seat door lock operating knob	-	-	-	-	-	-	-	1	-	-
226960	Rumble seat door lock operating knob ferrule	-	-	-	-	-	-	-	1	-	-
226961	Rumble seat door lock operating knob ferrule clinch plate	-	-	-	-	-	-	-	1	-	-
224831	Rumble seat door lock operating lever	-	-	-	-	-	-	1	-	-	-
228137	Rumble seat door lock operating rod yoke and clip assembly—front	-	-	-	-	-	-	-	1	-	-
173411	Rumble seat door lock operating rod and yoke end assembly	-	-	-	-	-	-	1	-	-	-
228149	Rumble seat door lock operating rod and yoke end assembly—rear	-	-	-	-	-	-	-	1	-	-
228135	Rumble seat door lock operating rod and yoke end assembly—side	-	-	-	-	-	-	-	1	-	-
7513	Yoke end adjustor 3/16	-	-	-	-	-	-	1	2	-	-
7003	Nut No. 10-32	-	-	-	-	-	-	1	2	-	-
7523	Yoke end pin 3/16	-	-	-	-	-	-	3	5	-	-
3906	Washer 3/16 "Y" standard	-	-	-	-	-	-	2	-	-	-
4690	Cotter pin 1/16 x 3/8	-	-	-	-	-	-	3	5	-	-
228142	Rumble seat door lock operating rod front clip	-	-	-	-	-	-	-	2	-	-
228143	Rumble seat door lock operating rod side clip	-	-	-	-	-	-	-	1	-	-
157625	Rumble seat door lock striker	-	-	-	-	-	-	1	1	-	-
226513	Rumble seat step upper gasket	-	-	-	-	-	-	1	1	-	-
226512	Rumble seat step upper mat	-	-	-	-	-	-	1	1	-	-
226512	Rumble seat step lower mat	-	-	-	-	-	-	1	1	-	-
226510	Rumble seat step upper assembly (L.H. drive)	-	-	-	-	-	-	1	1	-	-
231599	Rumble seat step upper assembly (R.H. drive)	-	-	-	-	-	-	1	1	-	-
5666	Stud 3/8	-	-	-	-	-	-	2	2	-	-
114055	Washer	-	-	-	-	-	-	2	2	-	-
5506	Lockwasher 3/8	-	-	-	-	-	-	2	2	-	-
7006	Nut 3/8-24	-	-	-	-	-	-	2	2	-	-
235222	Rumble seat step lower assembly	-	-	-	-	-	-	1	1	-	-
7804	Screw 5/16-18 x 3/4 hex. hd.	-	-	-	-	-	-	2	2	-	-
5504	Lockwasher 5/16"	-	-	-	-	-	-	2	2	-	-
235128	Rumble seat step lower bracket	-	-	-	-	-	-	1	1	-	-
310638	Rumble seat step lower bracket nut	-	-	-	-	-	-	1	1	-	-
220881	Lockwasher 3/4 (Shakeproof)	-	-	-	-	-	-	1	1	-	-

Piece No.	(16th Series) Name	No. Required									
		1112-1132 S P. Formal Sedan	1103-13-33 S P. Tour. Sedan	1114-34 7 P. Tour. Sedan	1115-35 7 P. Tour. Sedan Lim.	1116-36 S P. Club Sedan	1117-37 S P. Coupe	1118-38 2-4 P. Coupe	1119-39 2-4 P. Conv. Coupe	1143-93 S P. Conv. Sedan	1107-27 S P. Victoria
SUN VISOR											
325936	Sun visor—complete	-	-	-	-	-	-	-	2	2	2
235730	Sun visor assembly	2	2	2	2	2	2	2	-	-	-
235728	Sun visor hinge bracket assembly—right	1	1	1	1	1	1	1	-	-	-
235729	Sun visor hinge bracket assembly—left	1	1	1	1	1	1	1	-	-	-
241161	Screw 1/4-28 x 5/8 oval hd. (Phillip- conical point)	4	4	4	4	4	4	4	-	-	-
TOGGLE GRIP											
241120	Toggle grip (Used on 1103-12-13-14-15-16-17)	2	2	2	2	2	2	-	-	-	-
241121	Toggle grip (Used on 1132-33-34-35-36-37) ..	2	2	2	2	2	2	-	-	-	-
241123	Toggle grip pivot stud	2	2	2	2	2	2	-	-	-	-
187483	Toggle grip pivot stud screw bushing	2	2	2	2	2	2	-	-	-	-
229250	Toggle grip pivot stud spring washer	2	2	2	2	2	2	-	-	-	-
235841	Toggle grip pivot stud washer	2	2	2	2	2	2	-	-	-	-
5133	Toggle grip pivot stud spacer washer 1/2" ..	2	2	2	2	2	2	-	-	-	-
TOP											
241242	Top assembly—less fabric	-	-	-	-	-	-	-	-	1	-
241243	Top assembly—less fabric	-	-	-	-	-	-	-	-	-	1
241089	Top assembly—less fabric	-	-	-	-	-	-	-	1	-	-
0243695	Top bow No. 2	-	-	-	-	-	-	-	-	1	-
236622	Top bow No. 2 reinforcement—right	-	-	-	-	-	-	-	-	1	-
236623	Top bow No. 2 reinforcement—left	-	-	-	-	-	-	-	-	1	-
236661	Top bow auxiliary	-	-	-	-	-	-	-	-	1	-
0243626	Top bow auxiliary	-	-	-	-	-	-	-	-	-	1
0328570	Top bow auxiliary to rear bow slat iron bolt	-	-	-	-	-	-	-	-	2	2
229595	Top envelope assembly	-	-	-	-	-	-	-	1	-	-
243199	Top envelope assembly	-	-	-	-	-	-	-	-	-	1
243115	Top envelope assembly	-	-	-	-	-	-	-	-	1	-
0243642	Top folding pillar bracket upper right	-	-	-	-	-	-	-	1	-	-
0243643	Top folding pillar bracket upper left	-	-	-	-	-	-	-	1	-	-
0243650	Top folding pillar bracket to side rail shoulder bolt	-	-	-	-	-	-	-	-	2	-
228177	Top folding pillar bumper	-	-	-	-	-	-	-	x	-	-
228094	Top folding pillar hinge—right	-	-	-	-	-	-	-	1	-	-
228095	Top folding pillar hinge—left	-	-	-	-	-	-	-	1	-	-
236624	Top folding pillar hinge—right	-	-	-	-	-	-	-	-	1	-
236625	Top folding pillar hinge—left	-	-	-	-	-	-	-	-	1	-
236856	Top folding pillar hinge—right	-	-	-	-	-	-	-	-	-	1
236857	Top folding pillar hinge—left	-	-	-	-	-	-	-	-	-	1
235244	Top folding pillar hinge bracket—right	-	-	-	-	-	-	-	1	-	-
235245	Top folding pillar hinge bracket—left	-	-	-	-	-	-	-	1	-	-
236632	Top folding pillar hinge bracket—right	-	-	-	-	-	-	-	-	1	-
236633	Top folding pillar hinge bracket—left	-	-	-	-	-	-	-	-	1	-
236854	Top folding pillar hinge bracket—right	-	-	-	-	-	-	-	-	-	1
236855	Top folding pillar hinge bracket—left	-	-	-	-	-	-	-	-	-	1
8204	Screw 1/4-28 x 2 flat hd.	-	-	-	-	-	-	-	2	-	-
6852	Screw No. 12-24 x 1-5/8 flat hd.	-	-	-	-	-	-	-	-	4	-
6851	Screw No. 12-24 x 1 flat hd.	-	-	-	-	-	-	-	-	6	6
6853	Screw No. 12-24 x 2-1/4 flat hd.	-	-	-	-	-	-	-	-	2	4

Piece No.	(16th Series) Name	No. Required								
		1112-1132 S P. Formal Sedan	1103-1333 S P. Tour. Sedan	1114-34 7 P. Tour. Sedan	1115-35 7 P. Tour. Sedan Lim.	1116-36 S P. Club Sedan	1117-37 S P. Coupe	1118-38 2-4 P. Coupe	1119-39 2-4 P. Conv. Coupe	1143-53 S P. Conv. Sedan
228069	Top folding pillar hinge pin	-	-	-	-	-	-	2	-	-
227660	Top folding pillar hinge pin	-	-	-	-	-	-	-	2	2
236024	Top folding pillar pad--right	-	-	-	-	-	-	-	1	-
236025	Top folding pillar pad--left	-	-	-	-	-	-	-	1	-
0243614	Top front cross bar	-	-	-	-	-	-	1	1	1
0243617	Top front cross bar bracket to link rivet ..	-	-	-	-	-	-	2	-	-
0243618	Top front cross bar bracket side--right	-	-	-	-	-	-	1	-	-
0243786	Top front cross bar bracket side--right	-	-	-	-	-	-	-	1	-
0243619	Top front cross bar bracket side--left	-	-	-	-	-	-	1	-	-
0243787	Top front cross bar bracket side--left	-	-	-	-	-	-	-	1	-
0243652	Top front cross bar bracket side dowel pin .	-	-	-	-	-	-	2	2	2
0243633	Top front cross bar clamp adjusting bracket.	-	-	-	-	-	-	3	3	3
0243636	Top front cross bar clamp bracket--center ..	-	-	-	-	-	-	1	1	1
0243652	Top front cross bar clamp bracket center dowel	-	-	-	-	-	-	1	1	1
0241423	Top front cross bar clamp handle to adjust- ing bracket pin	-	-	-	-	-	-	6	6	6
0241426	Top front cross bar clamp handle	-	-	-	-	-	-	3	3	3
0241425	Top front cross bar clamp handle to link pin	-	-	-	-	-	-	3	3	3
0241419	Top front cross bar clamp link	-	-	-	-	-	-	3	3	3
227754	Top hold down clamp assembly--right (at re- movable pillar)	-	-	-	-	-	-	-	1	-
227755	Top hold down clamp assembly--left (at re- movable pillar)	-	-	-	-	-	-	-	1	-
6817	Screw No. 8-32 x 3/8 Phillips (oval hd.)	-	-	-	-	-	-	-	2	-
0243645	Top main bow	-	-	-	-	-	-	1	-	-
0243698	Top main bow	-	-	-	-	-	-	-	1	-
0243653	Top main bow	-	-	-	-	-	-	-	-	1
236536	Top main bow reinforcement--right	-	-	-	-	-	-	-	1	-
236537	Top main bow reinforcement--left	-	-	-	-	-	-	-	1	-
0243640	Top prop and rear bow slat and clevis handle assembly--right	-	-	-	-	-	-	1	-	-
0243641	Top prop and rear bow slat and clevis handle assembly--left	-	-	-	-	-	-	1	-	-
0243651	Top prop to side rail shoulder bolt	-	-	-	-	-	-	2	-	-
229440	Top prop to body bracket assembly--right ...	-	-	-	-	-	-	1	-	-
229441	Top prop to body bracket assembly--left	-	-	-	-	-	-	1	-	-
4163	Rivet	-	-	-	-	-	-	4	-	-
236853	Top prop to body bracket	-	-	-	-	-	-	-	-	2
236069	Top prop to body bracket	-	-	-	-	-	-	-	2	-
6303	Screw 1/4-28 x 1/2 oval hd.	-	-	-	-	-	-	-	8	8
236777	Top prop pivot screw	-	-	-	-	-	-	2	2	2
236776	Top prop pivot screw nut (serrated)	-	-	-	-	-	-	2	2	2
3877	Washer 3/8	-	-	-	-	-	-	2	2	2
0243637	Top rear bow	-	-	-	-	-	-	1	-	-
236325	Top rear bow	-	-	-	-	-	-	-	1	-
0243628	Top rear bow	-	-	-	-	-	-	-	-	1
229593	Top rear curtain assembly	-	-	-	-	-	-	1	-	-
243211	Top rear curtain assembly	-	-	-	-	-	-	-	-	1
243116	Top rear curtain assembly	-	-	-	-	-	-	-	1	-
227579	Top rear window glass	-	-	-	-	-	-	1	-	-
313561	Top rear window glass	-	-	-	-	-	-	-	1	1
313563	Top rear window glass frame--inner	-	-	-	-	-	-	-	1	1
313562	Top rear window glass frame--outer	-	-	-	-	-	-	-	1	1
6786	Screw No. 6-32 x 3/8 oval hd. (Phillips)	-	-	-	-	-	-	-	16	16
179131	Top rear window glass frame	-	-	-	-	-	-	1	-	-

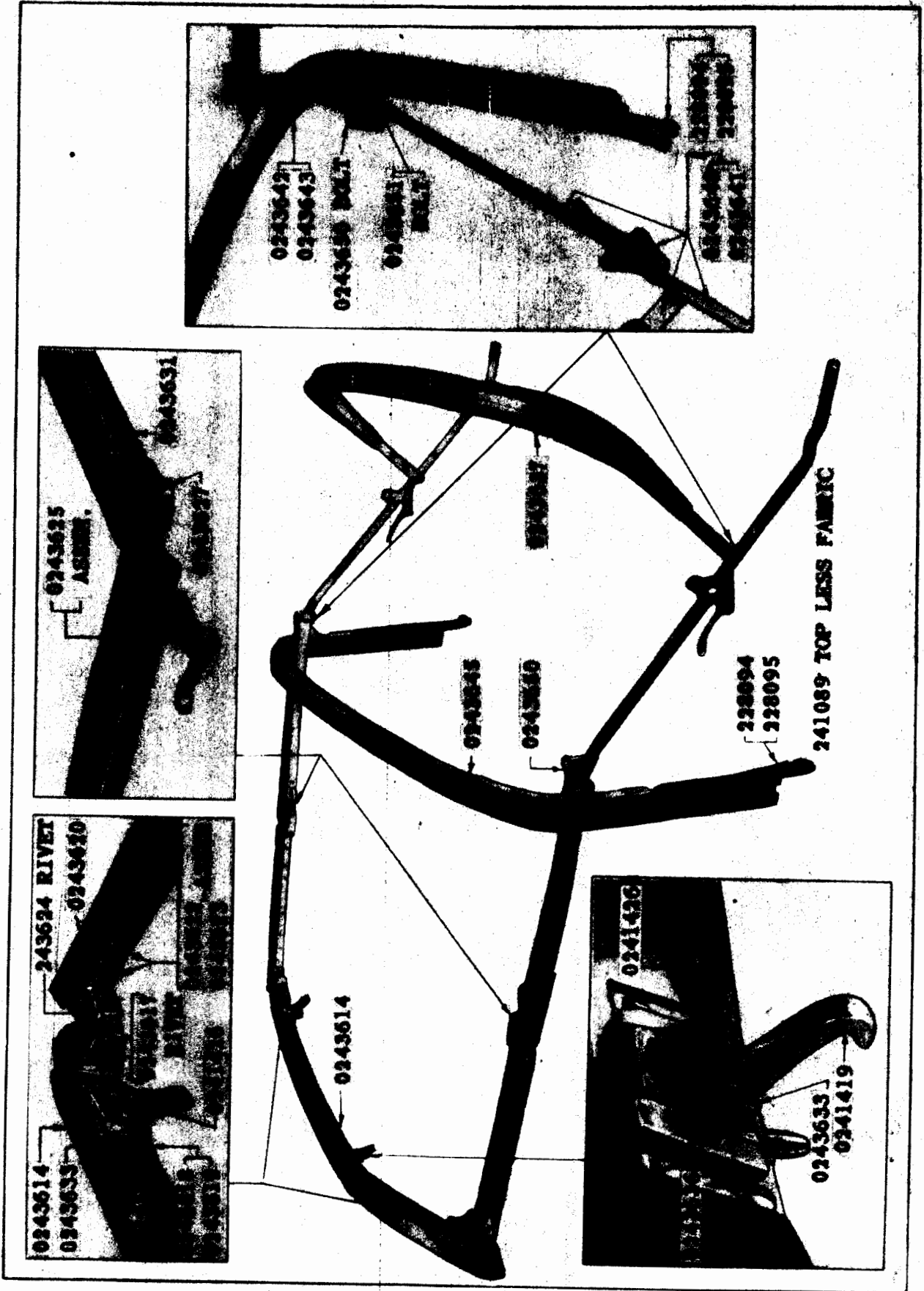

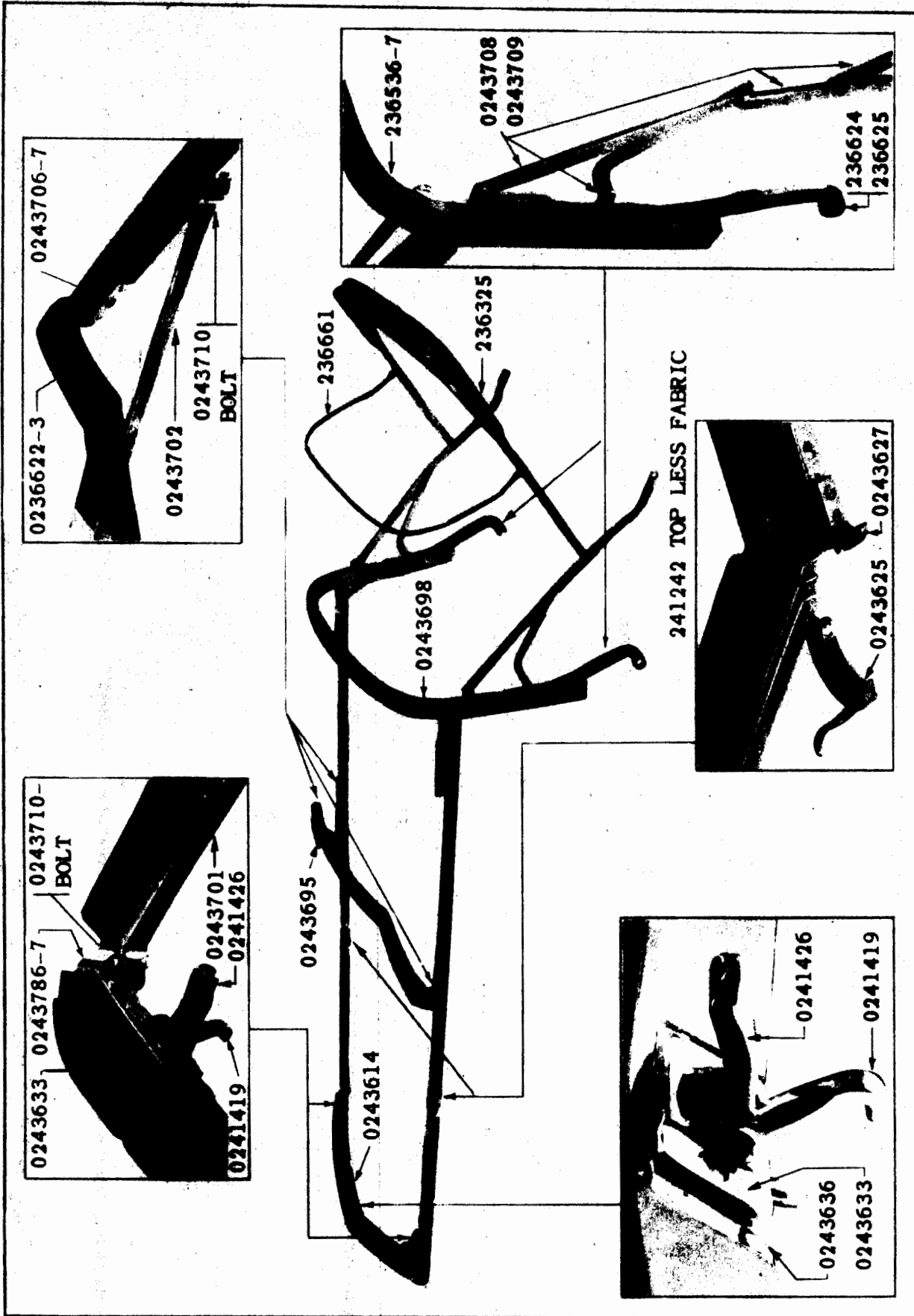

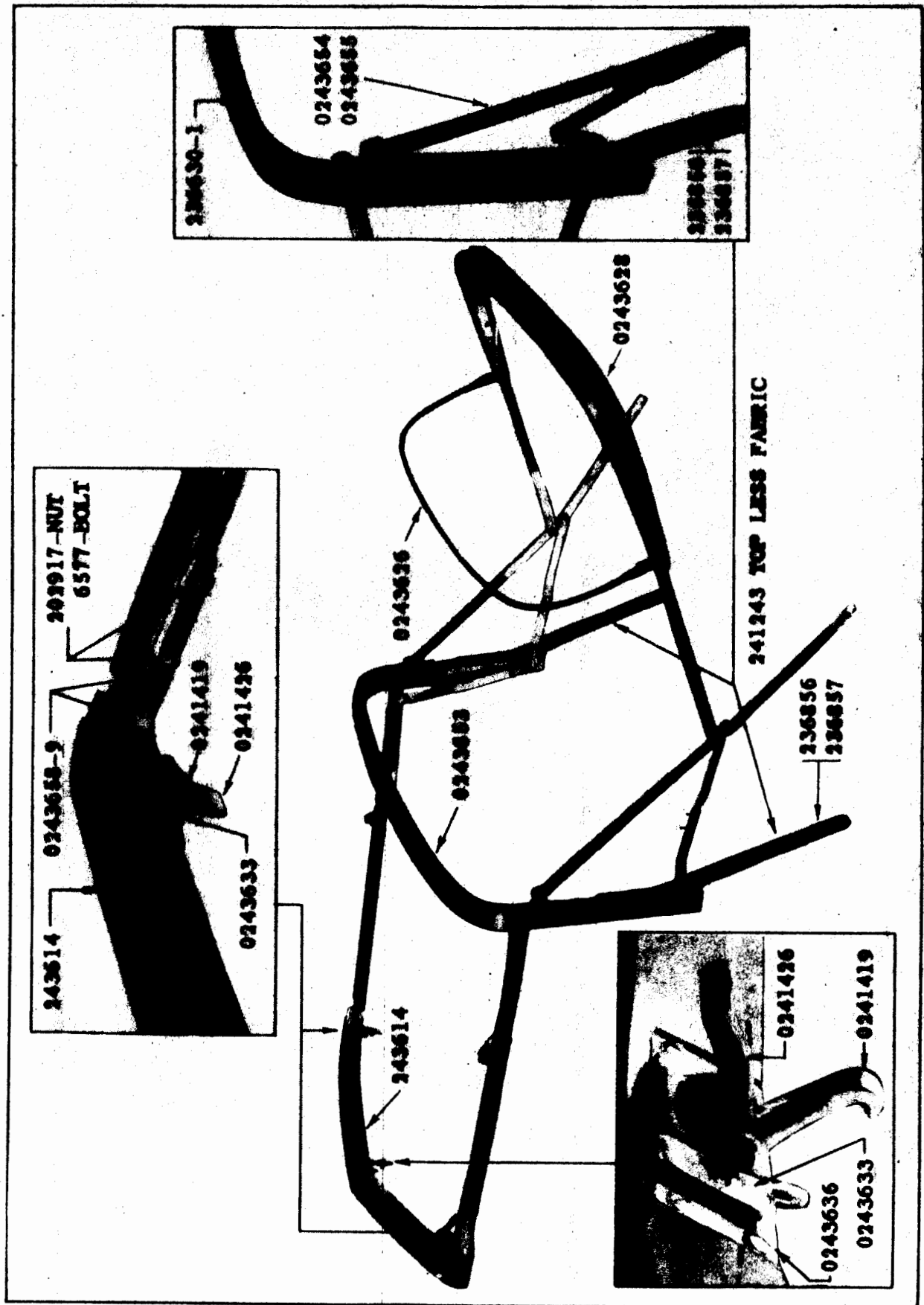



227660



236916



236777



227765



228069

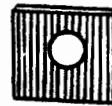

236776

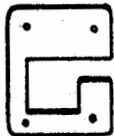

236132
236133



236104-5
243500-1



236166
236167



236069

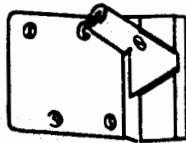

236106-7

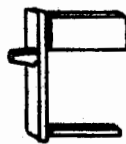

236108-9

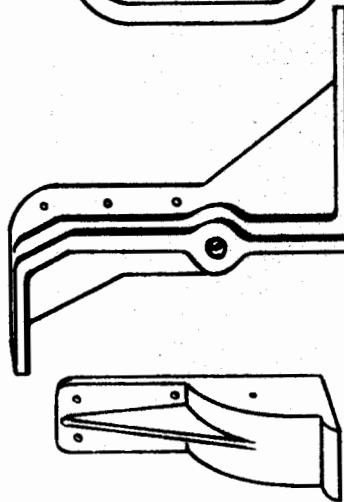

236632-236633



236853



236024
236025

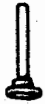

236673



236690
236691

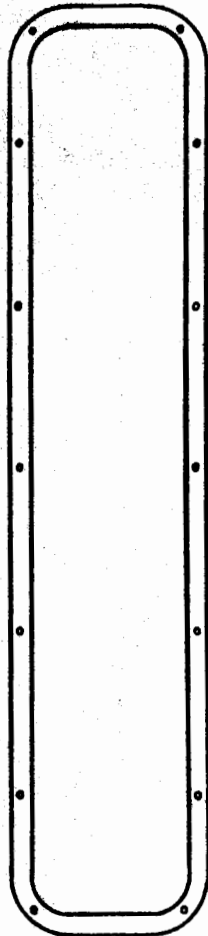

179131

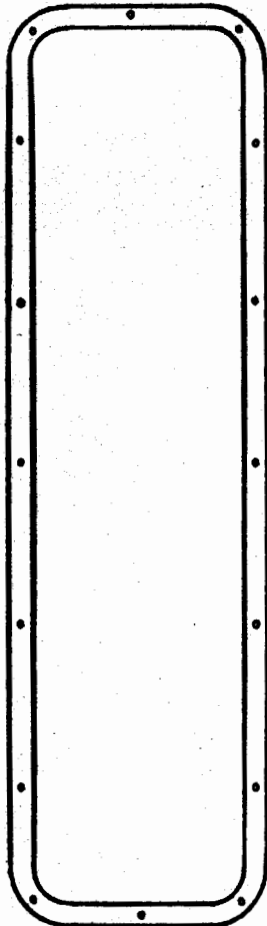

313563

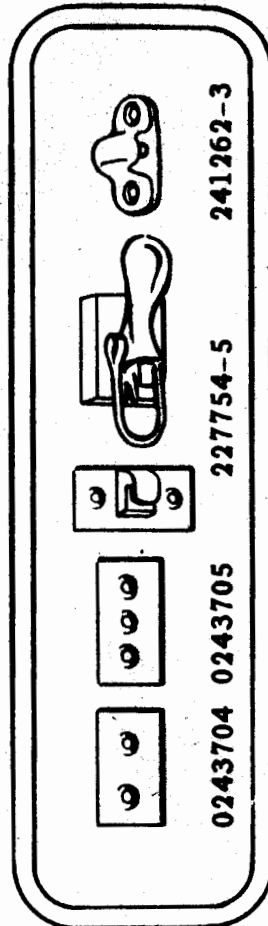

313562



241262-3



227754-5



0243704 0243705

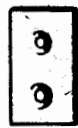
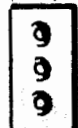

Piece No.	Name	(16th Series)										
		1112-1132 5 P. Formal Sedan	1109-19-33 5 P. Tour. Sedan	1114-24 7 P. Tour. Sedan	1115-35 7 P. Tour. Sedan Lim.	1116-36 5 P. Club Sedan	1117-37 5 P. Coupe	1118-38 2-4 P. Coupe	1119-39 2-4 P. Conv. Coupe	1143-53 5 P. Conv. Sedan	1107-27 5 P. Victoria	
		No. Required										
325919	Top rear window glass weatherstrip	-	-	-	-	-	-	-	-	-	1	1
236104	Top removable center pillar on body dovetail right (Not used with partition)	-	-	-	-	-	-	-	-	-	1	-
236105	Top removable center pillar on body dovetail left (Not used with partition)	-	-	-	-	-	-	-	-	-	1	-
0243701	Top side rail--front	-	-	-	-	-	-	-	-	-	2	-
0243702	Top side rail--center	-	-	-	-	-	-	-	-	-	2	-
243500	Top removable center pillar on body dovetail right (Used with partition)	-	-	-	-	-	-	-	-	-	1	-
243501	Top removable center pillar on body dovetail left (Used with partition)	-	-	-	-	-	-	-	-	-	1	-
236106	Top removable center pillar on pillar dovetail--right	-	-	-	-	-	-	-	-	-	1	-
236107	Top removable center pillar on pillar dovetail--left	-	-	-	-	-	-	-	-	-	1	-
236673	Top removable center pillar on pillar dovetail thumbcrew	-	-	-	-	-	-	-	-	-	2	-
236108	Top removable center pillar top lock--plate-- right	-	-	-	-	-	-	-	-	-	1	-
236109	Top removable center pillar top lock--plate-- left	-	-	-	-	-	-	-	-	-	1	-
236166	Top removable center pillar pad upper--right	-	-	-	-	-	-	-	-	-	1	-
236167	Top removable center pillar pad upper--left.	-	-	-	-	-	-	-	-	-	1	-
236132	Top removable center pillar pad lower--right	-	-	-	-	-	-	-	-	-	1	-
236133	Top removable center pillar pad lower--left.	-	-	-	-	-	-	-	-	-	1	-
236690	Top removable center pillar pad retainer-- upper--right	-	-	-	-	-	-	-	-	-	1	-
236691	Top removable center pillar pad retainer-- upper--left	-	-	-	-	-	-	-	-	-	1	-
0243631	Top side rail assembly--rear	-	-	-	-	-	-	-	-	2	-	-
227765	Top side rail bumper--center	-	-	-	-	-	-	-	-	-	2	-
0243704	Top side rail bumper plate--front	-	-	-	-	-	-	-	-	-	2	-
0243705	Top side rail bumper plate--rear	-	-	-	-	-	-	-	-	-	2	-
0243622	Top side rail front and bracket assembly-- right	-	-	-	-	-	-	-	-	1	-	-
0243623	Top side rail front and bracket assembly-- left	-	-	-	-	-	-	-	-	1	-	-
0243710	Top side rail front to cross bar bracket pivot bolt	-	-	-	-	-	-	-	-	-	2	-
0243624	Top side rail front bracket to link rivet ..	-	-	-	-	-	-	-	-	-	2	-
0243625	Top side rail hinge clamp assembly	-	-	-	-	-	-	-	-	2	2	-
0243627	Top side rail hinge clamp catch	-	-	-	-	-	-	-	-	2	2	-
0243644	Top side rail hinge clamp catch tapping plate	-	-	-	-	-	-	-	-	2	2	-
0243706	Top side rail locking dowel plate--right ...	-	-	-	-	-	-	-	-	-	1	-
0243707	Top side rail locking dowel plate--left	-	-	-	-	-	-	-	-	-	1	-
0243620	Top side rail--front bracket and cross bar bracket link--right	-	-	-	-	-	-	-	-	1	-	-
0243621	Top side rail--front bracket and cross bar bracket link--left	-	-	-	-	-	-	-	-	1	-	-
0243708	Top slat iron assembly--right	-	-	-	-	-	-	-	-	-	1	-
0243654	Top slat iron assembly--right	-	-	-	-	-	-	-	-	-	-	1
0243709	Top slat iron assembly--left	-	-	-	-	-	-	-	-	-	1	-
0243655	Top slat iron assembly--left	-	-	-	-	-	-	-	-	-	-	1
0243658	Top slat iron to front cross bar bracket-- right	-	-	-	-	-	-	-	-	-	-	1

Piece No.	(16 Series) Name	No. Required									
		1112-1132 5 P. Fernal Sedan	1109-19-33 5 P. Tour. Sedan	1114-34 7 P. Tour. Sedan	1119-35 7 P. Tour. Sedan Lim.	1116-36 5 P. Club Sedan	1117-37 5 P. Coupe	1118-38 2-4 P. Coupe	1119-39 2-4 P. Conv. Coupe	1143-53 5 P. Conv. Sedan	1107-27 5 P. Victoria
0243659	Top slat iron to front cross bar bracket-- left	-	-	-	-	-	-	-	-	-	1
6577	Screw 5/16-24 x 3/4 flat hd.	-	-	-	-	-	-	-	-	-	4
202917	Nut 5/16-24 blind	-	-	-	-	-	-	-	-	-	4
0243710	Top slat iron assembly to center slat iron shoulder bolt	-	-	-	-	-	-	-	-	2	-
241262	Top to windshield clamp catch--center	-	-	-	-	-	-	-	1	1	1
241263	Top to windshield clamp catch--side	-	-	-	-	-	-	-	2	2	2
6779	Screw No. 10-32 x 5/8 oval hd. (Phillips)	-	-	-	-	-	-	-	6	6	6
236916	Top to windshield header bumper	-	-	-	-	-	-	-	3	3	3
241106	Top to windshield header weatherstrip	-	-	-	-	-	-	-	1	1	1

TRUNK

235095	Trunk emblem (Used on 1103-12-13-14-15- 16-43)	1	1	1	1	1	-	-	-	1	-
235096	Trunk emblem (Used on 1132-33-34-35- 36-53)	1	1	1	1	1	-	-	-	1	-
62065	Washer 1/4	1	1	1	1	1	-	-	-	1	-
5502	Lockwasher	1	1	1	1	1	-	-	-	1	-
239617	Nut 1/4-20	1	1	1	1	1	-	-	-	1	-
235961	Trunk emblem base	1	1	1	1	1	-	-	-	1	-
235108	Trunk emblem base gasket	1	1	1	1	1	-	-	-	1	-
241013	Trunk--lid assembly	1	1	1	1	1	-	-	-	1	-
312636	Trunk--lid brace assembly	1	1	1	1	1	-	-	-	1	-
312666	Trunk--lid brace screw	2	2	2	2	2	-	-	-	2	-
312667	Trunk--lid brace screw spring washer 13/32 dia.	1	1	1	1	1	-	-	-	2	-
7304	Nut 1/4-20 plain	2	2	2	2	2	-	-	-	2	-
235963	Trunk--lid hinge assembly--left	-	-	-	-	1	-	-	-	-	-
235962	Trunk--lid hinge assembly--right	-	-	-	-	1	-	-	-	-	-
235857	Trunk--lid hinge assembly--left	1	1	1	1	-	-	-	-	1	-
235856	Trunk--lid hinge assembly--right	1	1	1	1	-	-	-	-	1	-
6650	Screw 1/4-20 x 1/2 hex. hd.	8	8	8	8	4	-	-	-	8	-
6735	Screw 1/4-20 x 5/8 hex. hd.	-	-	-	-	4	-	-	-	-	-
6751	Lockwasher 1/4 (Shakeproof)	8	8	8	8	8	-	-	-	8	-
235858	Trunk--lid hinge liner (body half)	2	2	2	2	2	-	-	-	2	-
235859	Trunk--lid hinge liner (lid half)	2	2	2	2	2	-	-	-	2	-
314021	Trunk--lid lock assembly	1	1	1	1	1	-	-	-	1	-
5676	Screw No. 10-32 x 3/8 rnd. hd.	8	8	8	8	8	-	-	-	8	-
5868	Screw No. 10-32 x 5/8 flat hd.	2	2	2	2	2	-	-	-	2	-
5491	Lockwasher No. 10 countersunk (Shakeproof)	2	2	2	2	2	-	-	-	2	-
5935	Lockwasher 3/16 (Shakeproof)	8	8	8	8	8	-	-	-	8	-
235793	Trunk--lid lock handle (With key lock)	1	1	1	1	1	-	-	-	1	-
326046	Trunk--lid lock handle gasket	1	1	1	1	1	-	-	-	1	-
5676	Trunk--lid lock handle screw No. 10-32 x 3/8 rnd. hd.	1	1	1	1	1	-	-	-	1	-
6587	Lockwasher No. 10 (Shakeproof)	1	1	1	1	1	-	-	-	1	-
307088	Trunk--lid lock handle--cylinder lock	1	1	1	1	1	-	-	-	1	-
0314920	Trunk--lid lock plunger assembly--right	1	1	1	1	1	-	-	-	1	-
0314921	Trunk--lid lock plunger assembly--left	1	1	1	1	1	-	-	-	1	-
0314922	Trunk--lid lock rack--right	1	1	1	1	1	-	-	-	1	-
0314923	Trunk--lid lock rack--left	1	1	1	1	1	-	-	-	1	-
236306	Trunk--lid lock striker--right	1	1	1	1	-	-	-	-	1	-



312666

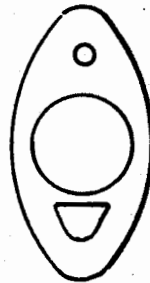

15th Series Only

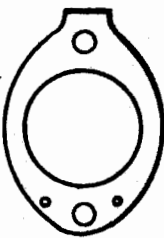

15th Series Only



235108

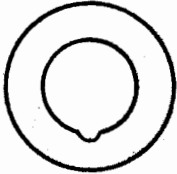

326046



307088

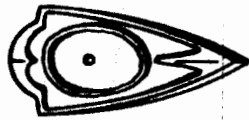

15th Series Only



235095 235096

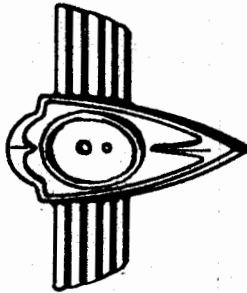

235961

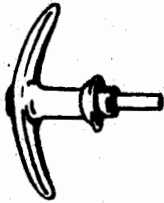

235793

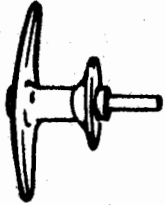

15th Series Only



15th Series Only



15th Series Only



235859



15th Series Only



235962 235856
235963 235857



235888



235304-5

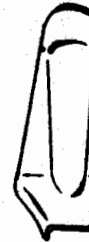

235306-235307

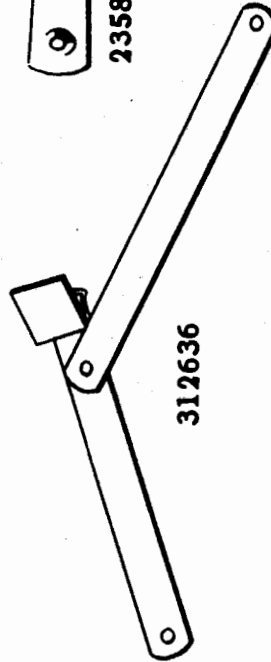

312636

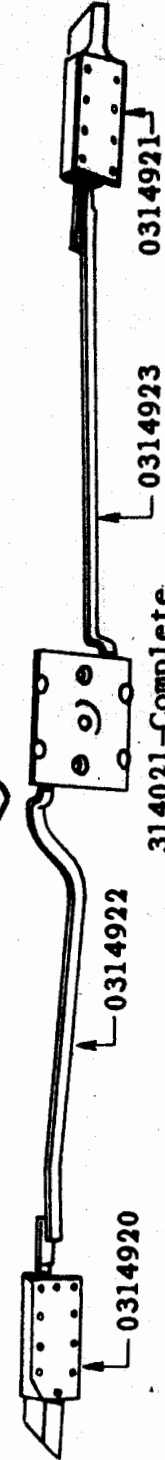

0314920

0314922

314021-Complete

0314923

0314921

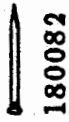

180082



184433



224629

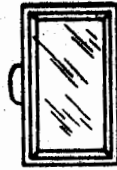

187596

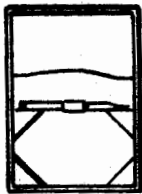

224262



224263

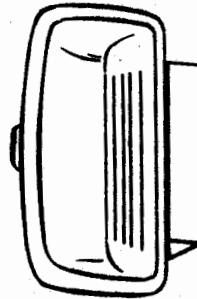

226031
241307



241125



235177

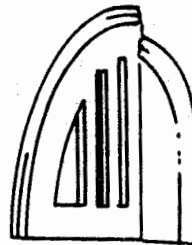

235888



235176

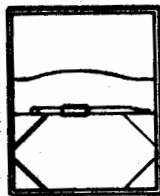

187594

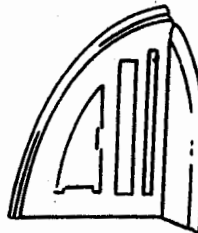

235930
235887

Piece No.	Name	(16th Series)									
		1112-1132 9 P. Formal Sedan	1103-13-33 5 P. Tour. Sedan	1114-34 7 P. Tour. Sedan	1115-35 7 P. Tour. Sedan Lim.	1116-36 5 P. Club Sedan	1117-37 5 P. Coupe	1118-38 2-4 P. Coupe	1119-39 2-4 P. Conv. Coupe	1143-53 5 P. Conv. Sedan	1107-37 5 P. Victoria
		No. Required									
235304	Trunk--lid lock striker--right	-	-	-	-	1	-	-	-	-	-
235307	Trunk--lid lock striker--left	1	1	1	1	-	-	-	-	1	-
235305	Trunk--lid lock striker--left	-	-	-	-	1	-	-	-	-	-
235420	Trunk--lid weatherstrip	1	1	1	1	1	-	-	-	1	-

VANITY CASE

235190	Vanity cabinet--right (Used on 1132)	1	-	-	-	-	-	-	-	-	-
235191	Vanity cabinet--left (Used on 1132)	1	-	-	-	-	-	-	-	-	-
235176	Vanity cabinet bottle (Used on 1132)	2	-	-	-	-	-	-	-	-	-
235177	Vanity cabinet memorandum book (Used on 1132)	2	-	-	-	-	-	-	-	-	-
184433	Vanity cabinet memorandum book pencil (Used on 1132)	2	-	-	-	-	-	-	-	-	-
226031	Vanity case assembly (Walnut) (Used on 1116)	-	-	-	-	1	-	-	-	-	-
241307	Vanity case assembly (Antiqua Tan) (Used on 1116)	-	-	-	-	1	-	-	-	-	-
105029	Vanity case assembly spring dowel (Used on 1116)	-	-	-	-	1	-	-	-	-	-
241125	Vanity case ash receiver (Used on 1112-13-14-15-17-1103)	1	1	1	1	-	1	-	-	-	-
235887	Vanity case cover plate (Used on 1117) (Antiqua Tan)	-	-	-	-	-	1	-	-	-	-
224503	Vanity case cover plate (Used on 1117) (Walnut)	-	-	-	-	-	1	-	-	-	-
235888	Vanity case cover plate (Used on 1114-15) (Antiqua Tan)	-	-	1	1	-	-	-	-	-	-
224676	Vanity case cover plate (Used on 1114-15) (Walnut)	-	-	1	1	-	-	-	-	-	-
235930	Vanity case cover plate--right (Used on 1112-13-1103) (Antiqua Tan)	1	1	-	-	-	-	-	-	-	-
235181	Vanity case cover plate--right (Used on 1112-13-1103) (Walnut)	1	1	-	-	-	-	-	-	-	-
224262	Vanity case memorandum book (Not used on 1116-1132)	1	1	1	1	1	1	-	-	1	1
187594	Vanity case memorandum book (Used on 1116)	-	-	-	-	1	-	-	-	-	-
180082	Vanity case memorandum book pencil (Not used on 1132)	1	1	1	1	1	1	-	-	1	1
224263	Vanity case mirror (Used on 1112-13-14-15-17-1103-1107-27-1143-53)	1	1	1	1	-	1	-	-	1	1
187596	Vanity case mirror (Used on 1116)	-	-	-	-	1	-	-	-	-	-
224629	Vanity case mirror (Used on 1133-34-35-36-37)	-	1	1	1	1	1	-	-	-	-

VENTILATOR

235690	Ventilator cover assembly	1	1	1	1	1	1	1	1	1	1
5198	Ventilator cover attaching screw No. 10-32 x 5/8 hex. hd.	3	3	3	3	3	3	3	3	3	3
6653	Washer 3/16	3	3	3	3	3	3	3	3	3	3
6056	Lockwasher 3/16 Shakeproof	3	3	3	3	3	3	3	3	3	3
7003	Nut No. 10-32	3	3	3	3	3	3	3	3	3	3
235704	Ventilator cover adjusting link--lower	1	1	1	1	1	1	1	1	1	1
235696	Ventilator cover adjusting link--upper	1	1	1	1	1	1	1	1	1	1
310145	Ventilator cover adjusting link rivet	1	1	1	1	1	1	1	1	1	1

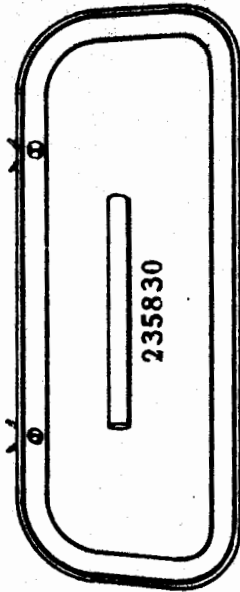

235830

15th Series Only

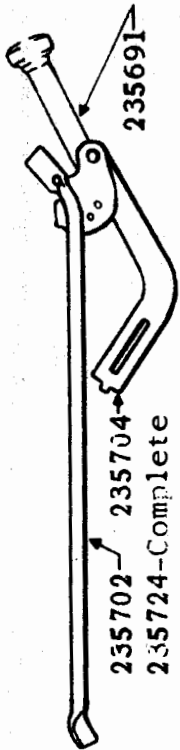

235702

235704

235724-Complete

235691



235700

15th Series Only

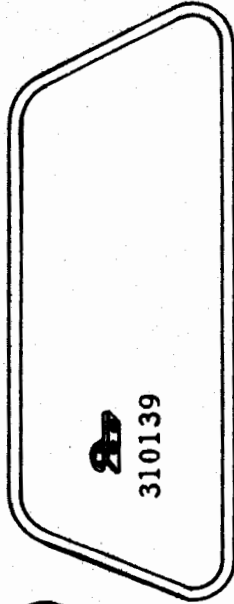

310139

15th Series Only

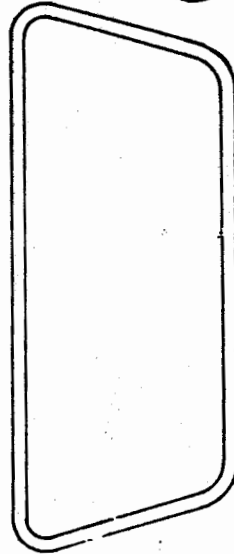

235757

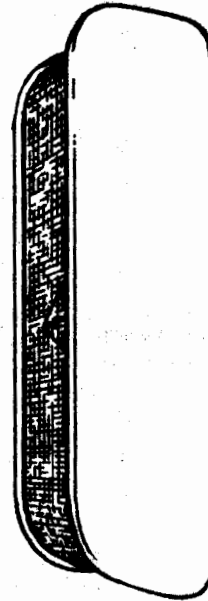

15th Series Only

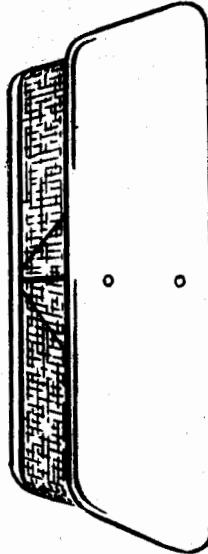

235690



235696



15th Series Only

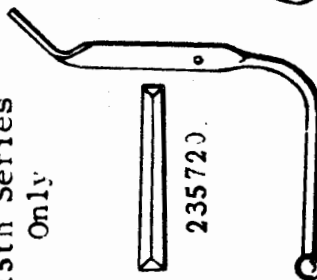

235720

15th Series Only

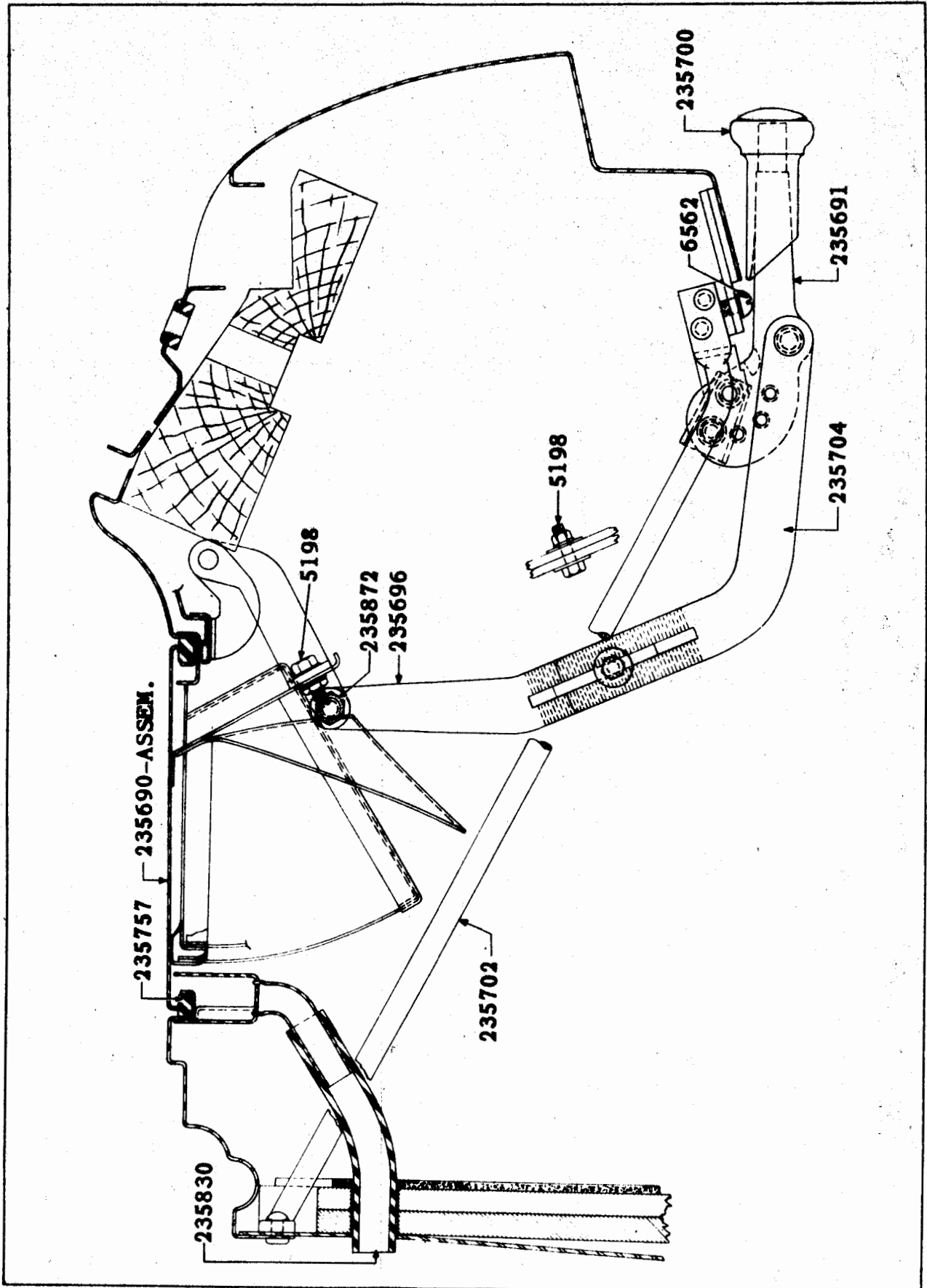

Piece No.	Name (16th Series)	No. Required									
		1112-1132 5 P. Formal Sedan	1103-1333 5 P. Tour. Sedan	1114-34 7 P. Tour. Sedan	1115-35 7 P. Tour. Sedan Lim.	1116-36 5 P. Club Sedan	1117-37 5 P. Coupe	1118-38 2-4 P. Coupe	1119-39 2-4 P. Conv. Coupe	1143-53 5 P. Conv. Sedan	1107-27 5 P. Victoria
314537	Ventilator cover adjusting link rivet										
	spring washer	1	1	1	1	1	1	1	1	1	
5198	Ventilator cover adjusting link screw										
	No. 10-32 x 5/8 hex. hd.	1	1	1	1	1	1	1	1	1	
3867	Washer No. 10 plain	2	2	2	2	2	2	2	2	2	
5500	Lockwasher No. 10	1	1	1	1	1	1	1	1	1	
7003	Nut No. 10-32	1	1	1	1	1	1	1	1	1	
235872	Ventilator cover adjusting link to hinge										
	screw	1	1	1	1	1	1	1	1	1	
5502	Lockwasher 1/4	1	1	1	1	1	1	1	1	1	
7004	Nut 1/4-28	1	1	1	1	1	1	1	1	1	
235720	Ventilator cover moulding	1	1	1	1	1	1	1	1	1	
6471	Screw No. 6-32 x 1/4 round hd.	2	2	2	2	2	2	2	2	2	
318999	Ventilator cover moulding rubber washer	2	2	2	2	2	2	2	2	2	
3867	Washer 3/16	2	2	2	2	2	2	2	2	2	
235702	Ventilator to dash panel brace	1	1	1	1	1	1	1	1	1	
4153	Rivet 3/16 x 7/16 round head	4	4	4	4	4	4	4	4	4	
235830	Ventilator drain tube hose	1	1	1	1	1	1	1	1	1	
235691	Ventilator handle	1	1	1	1	1	1	1	1	1	
5079	Ventilator handle ball	1	1	1	1	1	1	1	1	1	
310139	Ventilator handle ball and spring retainer	1	1	1	1	1	1	1	1	1	
310144	Ventilator handle ball and spring retainer										
	rivet	1	1	1	1	1	1	1	1	1	
310146	Ventilator handle ball spring	1	1	1	1	1	1	1	1	1	
235700	Ventilator handle knob	1	1	1	1	1	1	1	1	1	
235724	Ventilator handle support and link assembly	1	1	1	1	1	1	1	1	1	
6562	Screw 1/4-28 x 3/8 round hd.	2	2	2	2	2	2	2	2	2	
5502	Lockwasher 1/4	2	2	2	2	2	2	2	2	2	
235757	Ventilator weatherstrip	1	1	1	1	1	1	1	1	1	

WHEEL COMPARTMENT

241014	Wheel compartment door assembly	-	-	-	-	-	1	-	-	1
224973	Wheel compartment door brace assembly--left.	-	-	-	-	-	1	-	-	1
228121	Wheel compartment door brace assembly--right	-	-	-	-	-	1	-	-	1
5747	Screw 1/4-28 x 1-5/8 flat hd.	-	-	-	-	-	2	-	-	2
5676	Screw No. 10-32 x 3/8 round hd.	-	-	-	-	-	2	-	-	2
62065	Washer 1/4 plain special	-	-	-	-	-	2	-	-	2
5500	Lockwasher 3/16	-	-	-	-	-	2	-	-	2
7003	Nut No. 10-32	-	-	-	-	-	2	-	-	2
5502	Lockwasher 1/4	-	-	-	-	-	2	-	-	2
7004	Nut 1/4-28	-	-	-	-	-	2	-	-	2
111687	Wheel compartment door bumper	-	-	-	-	-	2	-	-	2
224840	Wheel compartment door drain gutter assembly	-	-	-	-	-	1	-	-	1
226065	Wheel compartment door hinge assembly--right	-	-	-	-	-	1	-	-	1
226066	Wheel compartment door hinge assembly--left.	-	-	-	-	-	1	-	-	1
8221	Screw 1/4-28 x 1-5/16 flat hd.	-	-	-	-	-	8	-	-	8
220783	Wheel compartment door hinge screw 5/16-24									
	x 1-1/2 hex. hd.	-	-	-	-	-	2	-	-	2
5504	Lockwasher 5/16	-	-	-	-	-	2	-	-	2
176282	Wheel compartment door lock	-	-	-	-	-	1	-	-	1
235943	Wheel compartment door lock handle (With									
	key lock)	-	-	-	-	-	1	-	-	1
307088	Wheel compartment door lock handle									
	cylinder lock	-	-	-	-	-	1	-	-	1



15th Series
Only



15th Series
Only

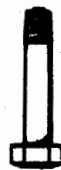

220783



111687



307088

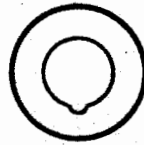

326046



15th Series
Only

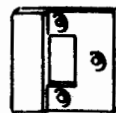

224910



231938

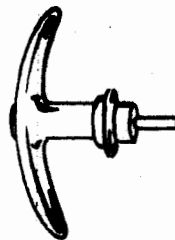

235943



176282

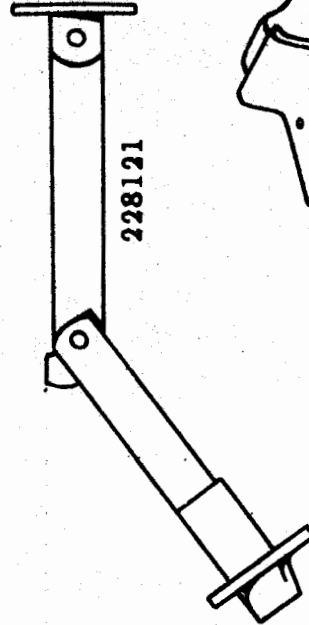

228121

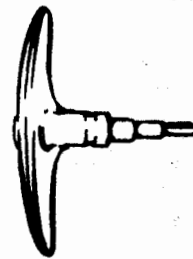

15th Series
Only



231989-235147



231937

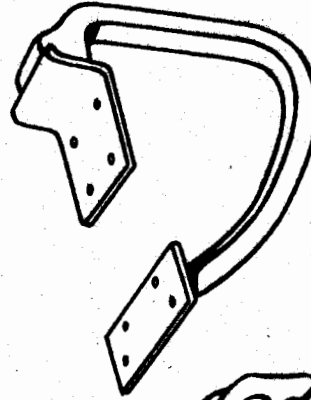

226065
226066

Piece No.	Name	(16th Series)									
		1112-1132 5 P. Formal Sedan	1103-13-33 5 P. Tour. Sedan	1114-34 7 P. Tour. Sedan	1115-35 7 P. Tour. Sedan Lim.	1116-36 5 P. Club Sedan	1117-37 5 P. Coupe	1118-38 2-4 P. Coupe	1119-39 2-4 P. Conv. Coupe	1143-53 5 P. Conv. Sedan	1107-27 5 P. Victoria
		No. Required									
235947	Wheel compartment door lock handle screw ...	-	-	-	-	-	1	-	-	-	-
185236	Wheel compartment door lock handle screw washer	-	-	-	-	-	1	-	-	-	-
326046	Wheel compartment door lock handle gasket ..	-	-	-	-	-	1	-	-	-	1
224910	Wheel compartment door lock striker	-	-	-	-	-	1	-	-	-	1
235975	Wheel compartment door panel	-	-	-	-	-	1	-	-	-	1
226269	Wheel compartment door weatherstrip--long ..	-	-	-	-	-	1	-	-	-	1
226286	Wheel compartment door weatherstrip--short .	-	-	-	-	-	1	-	-	-	1
231937	Wheel compartment tire clamp	1	1	1	1	1	1	-	-	1	1
231938	Wheel compartment tire clamp bolt	1	1	1	1	1	1	-	-	1	1
235147	Wheel compartment tire clamp bolt bracket assembly	1	1	1	1	-	-	-	-	1	-
231989	Wheel compartment tire clamp bolt bracket assembly	-	-	-	-	1	1	-	-	-	1
7824	Screw 1/4-28 x 5/8 hex. hd.	4	4	4	4	4	4	-	-	4	4
5502	Lockwasher 1/4	4	4	4	4	4	4	-	-	4	4
7004	Nut 1/4-28	4	4	4	4	4	4	-	-	4	4
231986	Wheel compartment tire stop	2	2	2	2	2	2	-	-	2	2
7824	Screw 1/4-28 x 5/8 hex. hd.	4	4	4	4	4	4	-	-	4	4
5502	Lockwasher 1/4	4	4	4	4	4	4	-	-	4	4
62065	Washer 1/4	4	4	4	4	4	4	-	-	4	4

WINDSHIELD

235882	Windshield cleaner to dash connection tube assembly	1	1	1	1	1	1	1	1	1	1
241165	Windshield cleaner dash tube to vacuum regulator hose	1	1	1	1	1	1	1	1	1	1
235824	Windshield cleaner driver assembly--right ..	1	1	1	1	1	1	1	1	1	1
235825	Windshield cleaner driver assembly--left ...	1	1	1	1	1	1	1	1	1	1
5873	Screw 1/4-28 x 9/16 hex. hd.	2	2	2	2	2	2	2	2	2	2
6751	Lockwasher 1/4 (Shakeproof)	2	2	2	2	2	2	2	2	2	2
235826	Windshield cleaner driver gasket	2	2	2	2	2	2	2	2	2	2
307165	Windshield cleaner driver shaft pivot felt washer	2	2	2	2	2	2	2	2	2	2
314286	Windshield cleaner driver shaft pivot retainer plate and spring assembly	1	1	1	1	1	1	1	1	1	1
235829	Windshield cleaner motor assembly	1	1	1	1	1	1	1	1	1	1
5739	Screw No. 10-32 x 1/2 hex. hd.	2	2	2	2	2	2	2	2	2	2
5818	Lockwasher No. 10 (Shakeproof)	2	2	2	2	2	2	2	2	2	2
235821	Windshield cleaner motor control assembly ..	1	1	1	1	1	1	1	1	1	1
325931	Windshield cleaner motor control assembly gasket	1	1	1	1	1	1	1	1	1	1
235822	Windshield cleaner motor control assembly knob	1	1	1	1	1	1	1	1	1	1
235749	Windshield cleaner motor support bracket ...	1	1	1	1	1	1	1	1	1	1
241164	Windshield cleaner motor vacuum regulator to motor hose	1	1	1	1	1	1	1	1	1	1
210070	Windshield cleaner vacuum pump dash conn. ..	1	1	1	1	1	1	1	1	1	1
7007	Nut 7/16-20	1	1	1	1	1	1	1	1	1	1
5806	Lockwasher 7/16 (Shakeproof)	1	1	1	1	1	1	1	1	1	1
3883	Plain washer 7/16	1	1	1	1	1	1	1	1	1	1
240629	Windshield cleaner vacuum pump to dash connection tube assembly (Used on 1103-12-13-1114-15-16-17-18-19-07-43)	1	1	1	1	1	1	1	1	1	1

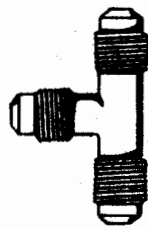

15th Series



235822

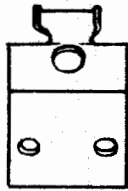

241163



15th Series Only



314286



15th Series Only



15th Series Only

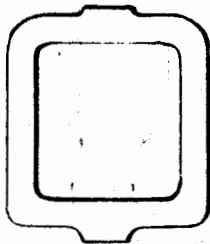

235826

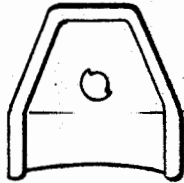

235678
241038



235710 15th Series 325931

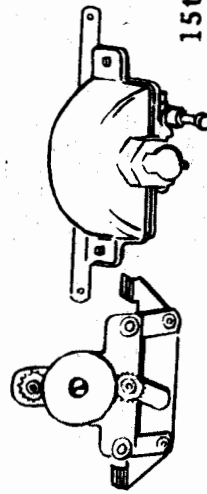

15th Series Only



15th Series 228939



235946

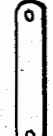

15th Series Only

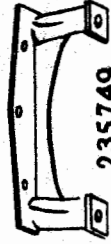

235749



235829

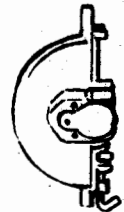

15th Series Only



241162 15th Series Only



15th Series



235824-5

15th Series

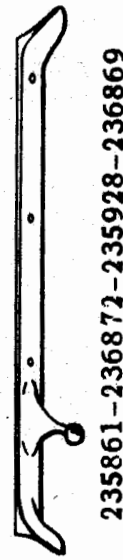
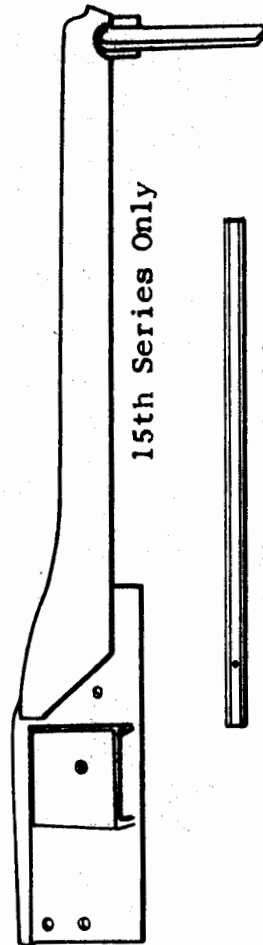
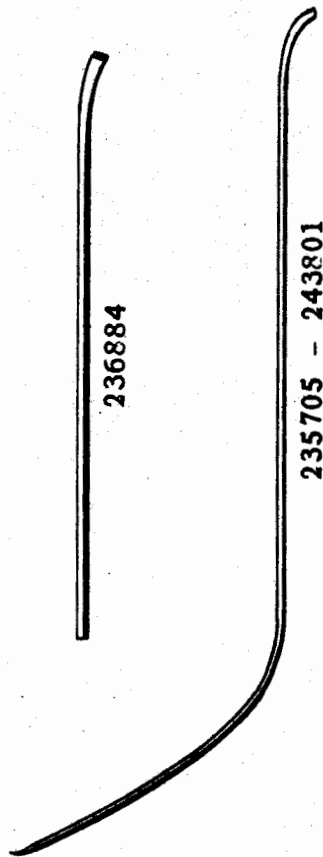
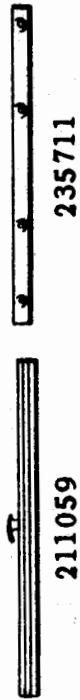
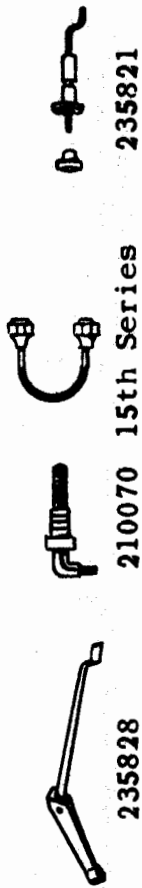

Piece No.	Name	(16th Series)									
		1112-1132 S P. Formal Sedan	1103-13-33 S P. Tour. Sedan	1114-34 7 P. Tour. Sedan	1115-35 7 P. Tour. Sedan Lim.	1116-36 S P. Club Sedan	1117-37 S P. Coupe	1118-38 2-4 P. Coupe	1119-39 2-4 P. Conv. Coupe	1143-53 S P. Conv. Sedan	1107-37 S P. Victoria
		No. Required									
240504	Windshield cleaner vacuum pump to dash connection tube assembly (Used on 1132-33-34-1135-36-37-38-39-27-53)	1	1	1	1	1	1	1	1	1	1
6399	Windshield cleaner vacuum pump to dash connection tube dash connection union nut 1/4 flared tube	1	1	1	1	1	1	1	1	1	1
6344	Nut 1/4 flared tube inverted weatherhead	1	1	1	1	1	1	1	1	1	1
6279	Elbow 1/4 flared tube inverted weatherhead	1	1	1	1	1	1	1	1	1	1
196973	Windshield cleaner vacuum pump to dash connection tube assembly clip (to frame) (Used on 1103-12-13-14-15-16-17-18-19-07-43)	1	1	1	1	1	1	1	1	1	1
229302	Windshield cleaner vacuum pump to dash connection tube assembly clip (to frame) screw 1/4-20 x 1/2 hex. hd. (Shakeproof) (Used on 1103-1112-13-14-15-16-17-18-19-07-43)	1	1	1	1	1	1	1	1	1	1
70128	Windshield cleaner vacuum pump to dash connection tube assembly clip (to dash) (Used on 1132-33-34-35-36-37-38-39-27-53)	1	1	1	1	1	1	1	1	1	1
7004	Nut 1/4-28 (Used on 1132-33-34-1135-36-37-38-39-27-53)	1	1	1	1	1	1	1	1	1	1
5502	Lockwasher 1/4 (Used on 1132-1133-34-35-36-37-38-39-27-53)	1	1	1	1	1	1	1	1	1	1
234975	Windshield cleaner vacuum pump to dash connection tube assembly clip (to oil gauge tube) (Used on 1132-33-34-35-36-37-38-39-27-1153)	2	2	2	2	2	2	2	2	2	2
228939	Windshield cleaner vacuum pump to dash connection tube assembly hose (Used on 1103-12-13-14-15-16-17-18-19-07-43)	1	1	1	1	1	1	1	1	1	1
241162	Windshield cleaner vacuum regulator assembly	1	1	1	1	1	1	1	1	1	1
5500	Lockwasher 3/16	1	1	1	1	1	1	1	1	1	1
6653	Washer 3/16 plain	1	1	1	1	1	1	1	1	1	1
7003	Nut No. 10-32	1	1	1	1	1	1	1	1	1	1
241163	Windshield cleaner vacuum regulator bracket.	1	1	1	1	1	1	1	1	1	1
8033	Screw No. 8-32 x 9/16 oval hd.	2	2	2	2	2	2	2	2	2	2
5695	Lockwasher No. 8	2	2	2	2	2	2	2	2	2	2
7002	Nut No. 8-32	2	2	2	2	2	2	2	2	2	2
211059	Windshield cleaner wiper	2	2	2	2	2	2	2	2	2	2
235828	Windshield cleaner wiper arm assembly	2	2	2	2	2	2	2	2	2	2
224668	Windshield cleaner wiper arm assembly nut ..	2	2	2	2	2	2	2	2	2	2
235774	Windshield division channel assembly	1	1	1	1	1	1	1	-	-	-
236981	Windshield division channel assembly	-	-	-	-	-	-	-	1	1	1
235678	Windshield division channel end filler-- upper	1	1	1	1	1	1	1	1	1	1
241038	Windshield division channel end filler-- lower	1	1	1	1	1	1	1	1	1	1
235861	Windshield division finishing moulding-- inside (Used on 1103-12-13-14-15-16-17-18) (Antiqua Tan)	1	1	1	1	1	1	1	-	-	-
236872	Windshield division finishing moulding-- inside (Used on 1107-19-43) (Antiqua Tan) ..	-	-	-	-	-	-	-	1	1	1
235928	Windshield division finishing moulding-- inside (Walnut)	1	1	1	1	1	1	1	-	-	-

Piece No.	Name (16th Series)	No. Required									
		1112-1132 S P. Formal Sedan	1103-13-33 S P. Tour. Sedan	1114-34 7 P. Tour. Sedan	1115-35 7 P. Tour. Sedan Lim.	1116-36 S P. Club Sedan	1117-37 S P. Coupe	1118-38 2-4 P. Coupe	1119-39 2-4 P. Conv. Coupe	1143-93 S P. Conv. Sedan	1107-27 S P. Victoria
236869	Windshield division finishing moulding—inside (Walnut)	-	-	-	-	-	-	-	1	1	1
6806	Screw No. 8-32 x 1-1/4 oval hd. (Phillips—header point)	4	4	4	4	4	4	4	4	4	4
199786	Windshield division finish moulding inside screw ferrule	4	4	4	4	4	4	4	4	4	4
235705	Windshield division finishing mldg.—outside	-	1	1	1	1	1	1	-	-	-
243801	Windshield division finishing mldg.—outside	1	-	-	-	-	-	-	-	-	-
236884	Windshield division finishing mldg.—outside	-	-	-	-	-	-	-	1	1	1
235706	Windshield division finishing moulding outside retainer—center	1	1	1	1	1	1	1	-	-	-
235710	Windshield division finishing moulding outside retainer—lower	1	1	1	1	1	1	1	1	1	1
235711	Windshield division finishing moulding outside retainer—upper	1	1	1	1	1	1	1	-	-	-
236875	Windshield division finishing moulding outside retainer—upper	-	-	-	-	-	-	-	1	1	1
235862	Windshield finishing moulding assembly (Used on 1103-12-13-14-15-16-17-18) (Antiqua Tan)	1	1	1	1	1	1	1	-	-	-
236880	Windshield finishing moulding assembly (Used on 1107-19-43) (Antiqua Tan)	-	-	-	-	-	-	-	1	1	1
235929	Windshield finishing moulding assembly (Walnut)	1	1	1	1	1	1	1	-	-	-
236951	Windshield finishing moulding assembly (Walnut)	-	-	-	-	-	-	-	1	1	1
6792	Screw No. 6-40 x 1 oval hd. cone point.	4	4	4	4	4	4	4	6	6	6
235771	Windshield finishing moulding assembly screw ferrule No. 6	10	10	10	10	10	10	10	10	10	10
235946	Windshield finishing moulding defroster hole grommet	2	2	2	2	2	2	2	2	2	2
235708	Windshield finishing rim—right	1	1	1	1	1	1	1	-	-	-
236882	Windshield finishing rim—right	-	-	-	-	-	-	-	1	1	1
235709	Windshield finishing rim—left	1	1	1	1	1	1	1	-	-	-
236883	Windshield finishing rim—left	-	-	-	-	-	-	-	1	1	1
235667	Windshield glass	2	2	2	2	2	2	2	-	-	-
236868	Windshield glass	-	-	-	-	-	-	-	2	2	2
235698	Windshield glass retainer—right	1	1	1	1	1	1	1	-	-	-
236970	Windshield glass retainer—right	-	-	-	-	-	-	-	1	1	1
235699	Windshield glass retainer—left	1	1	1	1	1	1	1	-	-	-
236971	Windshield glass retainer—left	-	-	-	-	-	-	-	1	1	1
220715	Windshield glass retainer screw No. 6 x 3/8 binding hd. (Parker Kalon) Type A	14	14	14	14	14	14	14	19	19	19
235751	Windshield glass weatherstrip—outer	1	1	1	1	1	1	1	-	-	-
236941	Windshield glass weatherstrip—outer	-	-	-	-	-	-	-	1	1	1
235860	Windshield glass weatherstrip—center	1	1	1	1	1	1	1	-	-	-
236866	Windshield glass weatherstrip—center	-	-	-	-	-	-	-	1	1	1
235611	Windshield header assembly	1	1	1	1	1	1	1	-	-	-
5684	Bolt 1/4-28 x 1-7/8 common carriage ...	2	-	-	-	-	-	-	-	-	-
7604	Bolt 1/4-28 x 1-5/8 common carriage ...	2	-	-	-	-	-	-	-	-	-
5502	Lockwasher 1/4	4	-	-	-	-	-	-	-	-	-
7004	Nut 1/4-28	4	-	-	-	-	-	-	-	-	-
8220	Screw 1/4-28 x 1-1/2 flat hd.	8	8	8	8	8	8	8	-	-	-
8234	Screw 1/4-28 x 1-3/4 flat hd.	2	2	2	2	2	2	2	-	-	-
224887	Washer countersunk (Shakeproof)	10	10	10	10	10	10	10	-	-	-
199045	Windshield header sun visor clinch nut	4	4	4	4	4	4	4	-	-	-

Expected Delivery Day Thursday, November 6.

Issue Postage: \$1.40

NACOGDOCHES, TX 75961-6739 \$1.61

Zone-3
First-Class Mail® Large Envelope
0 lb. 3.80 oz.
* Expected Delivery Day Wednesday, November 5.

Issue Postage: \$1.61

Total: \$3.01

Paid by:
MasterCard \$3.01
Account #: XXXXXXXXXXXX0380
Approval #: 57124Z
Transaction #: 721
23-902020270-99

SSK Transaction #: 26
USPS® #: 482233-9557

Thanks.
It's a pleasure to serve you.

ER-EIGHT AND TWELVE

Trimming 419

ries)

ie

ING

to difference in texture
ish sample when order-

c covered upholsterer
132-33-34-35-36-37-38).
c covered upholsterer

tufting (Used on 1132-33-34-35-36-37-38) .

	1112-1132 5 P. Formal Sedan	1103-13-33 5 P. Tour. Sedan	1114-34 7 P. Tour. Sedan	1115-35 7 P. Tour. Sedan Lim.	1116-36 5 P. Club Sedan	1117-37 5 P. Coupe	1118-38 2-4 P. Coupe	1119-39 2-4 P. Conv. Coupe	1143-93 5 P. Conv. Sedan	1107-27 5 P. Victoria
233534 Assembly-button leather covered tufting (Used on 1119-07-43)	-	-	-	-	-	-	-	X	X	X
233596 Assembly-button leather covered upholsterer (Used on 1135-39-27-53)	-	-	-	X	-	-	-	X	X	X
218016 Assembly-button leather covered upholsterer clinchier (Used on 1107-19-43)	-	-	-	-	-	-	-	X	X	X
233126 Assembly-button leather covered upholsterer clinchier (Used on 1127-35-39-53)	-	-	-	X	-	-	-	X	X	X
233540 Assembly-carpet floor front (Mohair) (Left hand drive) (Used on 1103-13-14-16)	-	1	1	-	1	-	-	-	-	-
233541 Assembly-carpet floor front (Mohair) (L.H. drive) (Used on 1112-1115) (With partition for 1113)	1	1	-	1	-	-	-	-	-	-
236781 Assembly-carpet floor front (Used on 1153-27)	-	-	-	-	-	-	-	-	1	1
233985 Assembly-carpet floor front (Used on 1107) (L.H. drive)	-	-	-	-	-	-	-	-	-	1
233588 Assembly-carpet floor front (Used on 1107) (R.H. drive)	-	-	-	-	-	-	-	-	-	1
233986 Assembly-carpet floor front (Used on 1143) .	-	-	-	-	-	-	-	-	1	-
233589 Assembly-carpet floor front (Mohair) (R.H. drive)	1	-	-	1	-	-	-	-	-	-
233657 Assembly-carpet floor front (Mohair) (R.H. drive)	-	-	-	-	-	-	-	1	-	-
233588 Assembly-carpet floor front (Mohair) (R.H. drive)	-	-	-	-	-	1	-	-	-	-
233591 Assembly-carpet floor front (Mohair) (R.H. drive)	-	1	1	-	1	-	-	-	-	-
233590 Assembly-carpet floor front (Mohair) (R.H. drive)	-	-	-	-	-	-	1	-	-	-
233052 Assembly-carpet floor front (Used on 1132- 35 and with partition for 1133)	1	1	-	1	-	-	-	-	-	-
233053 Assembly-carpet floor front (Used on 1138) .	-	-	-	-	-	-	1	-	-	-
233054 Assembly-carpet floor front (Used on 1133- 34-36)	-	1	1	-	1	-	-	-	-	-
233656 Assembly-carpet floor front (L.H. drive) (Used on 1119)	-	-	-	-	-	-	-	1	-	-
233542 Assembly-carpet floor front (L.H. drive) (Mohair) (Used on 1117)	-	-	-	-	-	1	-	-	-	-
233927 Assembly-carpet floor front (Used on 1139) .	-	-	-	-	-	-	-	1	-	-
233058 Assembly-carpet floor front (Used on 1137) .	-	-	-	-	-	1	-	-	-	-

No. Required

Piece No.	Name	(16th Series)									
		1112-1132 5 P. Formal Sedan	1103-13-33 5 P. Tour. Sedan	1114-34 7 P. Tour. Sedan	1119-35 7 P. Tour. Sedan Lim.	1116-36 5 P. Club Sedan	1117-37 5 P. Coupe	1118-38 2-4 P. Coupe	1119-39 2-4 P. Conv. Coupe	1143-53 5 P. Conv. Sedan	1107-27 5 P. Victoria
		No. Required									
233543	Assembly-carpet floor front (Mohair) (L.H. drive) (Used on 1118)	-	-	-	-	-	-	1	-	-	-
233544	Assembly-carpet floor rear (Mohair) (Used on 1114)	-	-	1	-	-	-	-	-	-	-
233545	Assembly-carpet floor rear (Mohair) (Used on 1115)	-	-	-	1	-	-	-	-	-	-
233278	Assembly-carpet floor rear (Used on 1134) ..	-	-	1	-	-	-	-	-	-	-
218183	Assembly-carpet floor rear (Used on 1135) ..	-	-	-	1	-	-	-	-	-	-
233546	Assembly-carpet floor rear (Mohair) (Used on 1103)	-	1	-	-	-	-	-	-	-	-
233547	Assembly-carpet floor rear (Mohair) (Used on 1113)	-	1	-	-	-	-	-	-	-	-
233280	Assembly-carpet floor rear (Used on 1133) ..	-	1	-	-	-	-	-	-	-	-
233548	Assembly-carpet floor rear (Mohair) (Used on 1116)	-	-	-	-	1	-	-	-	-	-
233549	Assembly-carpet floor rear (Mohair) (Used on 1112 with partition for 1113)	1	-	-	-	-	-	-	-	-	-
233487	Assembly-carpet floor rear (Used on 1132) (With partition for 1133)	1	1	-	-	-	-	-	-	-	-
233281	Assembly-carpet floor rear (Used on 1136) ..	-	-	-	-	1	-	-	-	-	-
229775	Assembly-carpet floor rear (Used on 1137) ..	-	-	-	-	-	1	-	-	-	-
233550	Assembly-carpet floor rear (Mohair) (Used on 1117)	-	-	-	-	-	1	-	-	-	-
233992	Assembly-carpet floor rear (Used on 1143) ..	-	-	-	-	-	-	-	1	-	-
233991	Assembly-carpet floor rear (Used on 1107) ..	-	-	-	-	-	-	-	-	1	-
236743	Assembly-carpet floor rear (Used on 1127) ..	-	-	-	-	-	-	-	-	1	-
236780	Assembly-carpet floor rear (Used on 1153) ..	-	-	-	-	-	-	-	1	-	-
233551	Assembly-carpet folding seat floor (Mohair) (Used on 1114)	-	-	2	-	-	-	-	-	-	-
233552	Assembly-carpet folding seat floor (Mohair) (Used on 1115)	-	-	-	2	-	-	-	-	-	-
233553	Assembly-carpet folding seat heel board (Mohair) (Used on 1114-15)	-	-	2	2	-	-	-	-	-	-
226432	Assembly-carpet floor rear compartment (Used on 1137)	-	-	-	-	-	1	-	-	-	-
233619	Assembly-carpet rear compartment floor pad (Use with side wheel carrier) (Use with body 1137)	-	-	-	-	-	1	-	-	-	-
229706	Assembly-carpet rumble seat compartment floor (Used on 1119)	-	-	-	-	-	-	1	-	-	-
229705	Assembly-carpet rumble seat compartment floor (Used on 1139)	-	-	-	-	-	-	1	-	-	-
229585	Assembly-carpet rumble seat compartment floor (Used on 1118)	-	-	-	-	-	-	1	-	-	-
226437	Assembly-carpet rumble seat compartment floor (Used on 1138)	-	-	-	-	-	-	1	-	-	-
317235	Assembly-carpet trunk compartment floor (Used on 1136)	-	-	-	-	1	-	-	-	-	-
233514	Assembly-carpet trunk compartment floor (Use with side wheel carrier) (Used on 1132-1133-34-35)	1	1	1	1	-	-	-	-	-	-
317234	Assembly-carpet trunk compartment floor (Used on 1132-33-34-35)	1	1	1	1	-	-	-	-	-	-
233515	Assembly-carpet trunk compartment floor (Use with side wheel carrier) (Used on 1136)	-	-	-	-	1	-	-	-	-	-

Piece No.	Name	(16th Series)										
		1112-1132 S P. Formal Sedan	1103-13-33 S P. Tour. Sedan	1114-34 7 P. Tour. Sedan	1115-35 7 P. Tour. Sedan Lim.	1116-36 S P. Club Sedan	1117-37 S P. Coupe	1118-38 2-4 P. Coupe	1119-39 2-4 P. Conv. Coupe	1143-53 S P. Conv. Sedan	1107-27 S P. Victoria	
		No. Required										
244018	Assembly-carpet trunk compartment floor (Used on 1153) (Side wheel carrier)	-	-	-	-	-	-	-	-	-	1	-
244019	Assembly-carpet trunk compartment floor (Used on 1143) (Side wheel carrier)	-	-	-	-	-	-	-	-	-	1	-
244020	Assembly-carpet trunk compartment floor pan (Used on 1127) (Side wheel carrier)	-	-	-	-	-	-	-	-	-	1	-
244001	Assembly-carpet trunk compartment shelf (Rear carrier)	-	-	-	-	-	-	-	-	-	1	-
233741	Assembly-door trimming front--left (Used on 1112-13-14)	1	1	1	-	-	-	-	-	-	-	-
233743	Assembly-door trimming front--left (Used on 1103-16)	-	1	-	-	1	-	-	-	-	-	-
233017	Assembly-door trimming front--left (Used on 1137-38)	-	-	-	-	-	1	1	-	-	-	-
233035	Assembly-door trimming front--left (Used on 1119)	-	-	-	-	-	-	-	-	1	-	-
233011	Assembly-door trimming front--left (Used on 1132-33-34)	1	1	1	-	-	-	-	-	-	-	-
233018	Assembly-door trimming front--left (Used on 1139)	-	-	-	-	-	-	-	-	1	-	-
233013	Assembly-door trimming front--left (Used on 1136)	-	-	-	-	1	-	-	-	-	-	-
233745	Assembly-door trimming front--left (Used on 1115)	-	-	-	1	-	-	-	-	-	-	-
233015	Assembly-door trimming front--left (Used on 1135)	-	-	-	1	-	-	-	-	-	-	-
233747	Assembly-door trimming front--left (Used on 1117-18)	-	-	-	-	-	1	1	-	-	-	-
233742	Assembly-door trimming front--right (Used on 1103-16)	-	1	-	-	1	-	-	-	-	-	-
233034	Assembly-door trimming front--right (Used on 1119)	-	-	-	-	-	-	-	-	1	-	-
233016	Assembly-door trimming front--right (Used on 1137-38)	-	-	-	-	-	1	1	-	-	-	-
233740	Assembly-door trimming front--right (Used on 1112-13-14)	1	1	1	-	-	-	-	-	-	-	-
233019	Assembly-door trimming front--right (Used on 1139)	-	-	-	-	-	-	-	-	1	-	-
233010	Assembly-door trimming front--right (Used on 1132-33-34)	1	1	1	-	-	-	-	-	-	-	-
233746	Assembly-door trimming front--right (Used on 1117-18)	-	-	-	-	-	1	1	-	-	-	-
233012	Assembly-door trimming front--right (Used on 1136)	-	1	-	-	1	-	-	-	-	-	-
233014	Assembly-door trimming front--right (Used on 1135)	-	-	-	1	-	-	-	-	-	-	-
233744	Assembly-door trimming front--right (Used on 1115)	-	-	-	1	-	-	-	-	-	-	-
243050	Assembly-door trimming front--right (Used on 1107)	-	-	-	-	-	-	-	-	-	-	1
243051	Assembly-door trimming front--left (Used on 1107)	-	-	-	-	-	-	-	-	-	-	1
243052	Assembly-door trimming front--right (Used on 1127)	-	-	-	-	-	-	-	-	-	-	1
243053	Assembly-door trimming front--left (Used on 1127)	-	-	-	-	-	-	-	-	-	-	1

Piece No.	Name (16th Series)	No. Required									
		1112-1132 5 P. Formal Sedan	1103-13-33 5 P. Tour. Sedan	1114-24 7 P. Tour. Sedan	1115-35 7 P. Tour. Sedan Lim.	1116-36 5 P. Club Sedan	1117-37 5 P. Coupe	1118-38 2-4 P. Coupe	1119-39 2-4 P. Conv. Coupe	1143-53 5 P. Conv. Sedan	1107-27 5 P. Victoria
243100	Assembly-door trimming front--right (Used on 1143)	-	-	-	-	-	-	-	-	1	-
243101	Assembly-door trimming front--left (Used on 1143)	-	-	-	-	-	-	-	-	1	-
243140	Assembly-door trimming front--right (Used on 1153)	-	-	-	-	-	-	-	-	1	-
243141	Assembly-door trimming front--left (Used on 1153)	-	-	-	-	-	-	-	-	1	-
233751	Assembly-door trimming rear--left (Used on 1103)	-	1	-	-	-	-	-	-	-	-
233021	Assembly-door trimming rear--left (Used on 1132-33)	1	1	-	-	-	-	-	-	-	-
233753	Assembly-door trimming rear--left (Used on 1114-15-16)	-	-	1	1	1	-	-	-	-	-
233755	Assembly-door trimming rear--left (Used on 1112-13)	1	1	-	-	-	-	-	-	-	-
233023	Assembly-door trimming rear--left (Used on 1134-35-36)	-	-	1	1	1	-	-	-	-	-
233750	Assembly-door trimming rear--right (Used on 1103)	-	1	-	-	-	-	-	-	-	-
233020	Assembly-door trimming rear--right (Used on 1132-33)	1	1	-	-	-	-	-	-	-	-
233752	Assembly-door trimming rear--right (Used on 1114-15-16)	-	-	1	1	1	-	-	-	-	-
233754	Assembly-door trimming rear--right (Used on 1112-13)	1	1	-	-	-	-	-	-	-	-
233022	Assembly-door trimming rear--right (Used on 1134-35-36)	-	-	1	1	1	-	-	-	-	-
243102	Assembly-door trimming rear--right (Used on 1143)	-	-	-	-	-	-	-	-	1	-
243103	Assembly-door trimming rear--left (Used on 1143)	-	-	-	-	-	-	-	-	1	-
243142	Assembly-door trimming rear--right (Used on 1153)	-	-	-	-	-	-	-	-	1	-
243143	Assembly-door trimming rear--left (Used on 1153)	-	-	-	-	-	-	-	-	1	-
229715	Assembly-golf compartment door trimming	-	-	-	-	-	-	-	2	-	-
229569	Assembly-golf compartment door trimming	-	-	-	-	-	-	2	-	-	-
233760	Assembly headlining (Specify set number) (Used with wood roof bows)	1	-	-	-	-	-	-	-	-	-
233761	Assembly headlining (Specify set number) (Used on 1103) (Used with wood roof bows)	-	1	-	-	-	-	-	-	-	-
233762	Assembly headlining (Specify set number) (Used on 1113-33) (Used with wood roof bows)	-	1	-	-	-	-	-	-	-	-
233763	Assembly-headlining (Specify set number) (Used with wood roof bows)	-	-	1	-	-	-	-	-	-	-
233764	Assembly-headlining (Specify set number) (Used with wood roof bows)	-	-	-	-	1	-	-	-	-	-
233765	Assembly-headlining (Specify set number) (Used with wood roof bows)	-	-	-	-	-	1	-	-	-	-
233766	Assembly-headlining (Specify set number) (Used with wood roof bows)	-	-	-	-	-	-	1	-	-	-
233767	Assembly-headlining front compartment (Specify set number) (Used with wood roof bows)	-	-	-	1	-	-	-	-	-	-

Piece No.	Name	(16th Series)									
		1112-1132 5 P. Formal Sedan	1103-1133 5 P. Tour. Sedan	1114-34 7 P. Year. Sedan	1115-35 7 P. Tour. Sedan Lim.	1116-36 5 P. Club Sedan	1117-37 5 P. Coupe	1118-38 2-4 P. Coupe	1119-39 2-4 P. Conv. Coupe	1143-33 5 P. Conv. Sedan	1107-37 5 P. Victoria
		No. Required									
233768	Assembly-headlining rear compartment (Specify set number) (Used with wood roof bows)	-	-	-	1	-	-	-	-	-	-
243008	Assembly-headlining (Specify set number) (Use with metal roof bows)	1	-	-	-	-	-	-	-	-	-
243009	Assembly-headlining (Specify set number) (Use with metal roof bows)	-	1	-	-	-	-	-	-	-	-
243010	Assembly-headlining (Specify set number) (Use with metal roof bows) (Used on 1113-33)	-	1	-	-	-	-	-	-	-	-
243011	Assembly-headlining (Specify set number) (Use with metal roof bows)	-	-	1	-	-	-	-	-	-	-
243012	Assembly-headlining (Specify set number) (Use with metal roof bows)	-	-	-	-	1	-	-	-	-	-
243013	Assembly-headlining (Specify set number) (Use with metal roof bows)	-	-	-	-	-	1	-	-	-	-
243014	Assembly-headlining (Specify set number) (Use with metal roof bows)	-	-	-	-	-	-	1	-	-	-
243015	Assembly-headlining front compartment (Specify set number) (Use with metal roof bows)	-	-	-	1	-	-	-	-	-	-
243016	Assembly-headlining rear (Specify set number) (Use with metal roof bows)	-	-	-	1	-	-	-	-	-	-
226425	Assembly-pad folding seat compartment floor (Used on 1134-35)	-	-	2	2	-	-	-	-	-	-
139910	Binding cloth wire-on (Pattern Vogt No. 935) (Specify set number) (Used on 1112-1103-13-14-15-16-17-18)	x	x	x	x	x	x	x	-	-	-
233353	Binding cloth wire-on (Pattern Vogt No. 936) (Specify set number) (Used on 1132-33-34-35-36-38)	x	x	x	x	x	-	x	-	-	-
228405	Binding cloth wire-on (Top fabric) (Specify set number)	-	-	-	-	-	-	-	x	x	x
167438	Binding cloth wire-on (Cordless) (1/2" wide) (Pattern Vogt No. 935) (Specify set number) (Used on 1112-1103-13-14-15-16-17-18)	x	x	x	x	x	x	x	-	-	-
233354	Binding cloth wire-on (Cordless 1/2" wide) (Pattern Vogt No. 936) (Specify set number) (Used on 1132-33-34-35-36-37-38)	x	x	x	x	x	x	x	-	-	-
156596	Binding lace 7/16" (Specify set number) (Used on 1133-34-35-36-37-39-1107)	-	x	x	x	x	x	-	x	-	x
312435	Binding carpet 1" wide (Herring bone weave) (Specify set number) (Used on 1112-1103-13-14-15-16-1117-1107-43)	x	x	x	x	x	x	-	-	-	-
127259	Binding carpet (Specify set number)	x	x	x	x	x	x	x	x	x	x
306536	Binding 1-1/8" bias cut--black imitation (Specify set number)	x	x	x	x	x	x	x	-	-	-
228406	Binding 3/4" Gimp--top fabric (Specify set number)	-	-	-	-	-	-	-	x	x	x
233939	Binding--imitation leather wire on (Specify set number)	-	-	-	-	-	-	-	x	x	x
226984	Binding leather wire-on Natural Grain (Specify set number)	-	-	-	x	-	-	x	x	x	x
206731	Binding rattan 3/8" half round (Specify set number) (Used on 1133-34-35)	-	x	x	x	-	-	-	-	-	-

Piece No.	Name (16th Series)	No. Required									
		1112-1132 5 P. Formal Sedan	1103-13-33 5 P. Tour. Sedan	1114-34 7 P. Tour. Sedan	1115-35 7 P. Tour. Sedan Lim.	1116-36 5 P. Club Sedan	1117-37 5 P. Coupe	1118-38 2-4 P. Coupe	1119-39 2-4 P. Conv. Coupe	1143-43 5 P. Conv. Sedan	1107-27 5 P. Victoria
177812	Binding tip-wire-on top--left	-	-	-	-	-	-	-	X	X	X
177813	Binding tip-wire-on top--right	-	-	-	-	-	-	-	X	X	X
233265	Binding weatherstrip (Pattern Vogt No. 935) (Specify set number) (Used on 1112-1103- 13-14-15-16-17-18)	X	X	X	X	X	X	X	-	-	-
233356	Binding weatherstrip (Pattern Vogt No. 936) (Specify set number) (Used on 1132-33-34- 35-36-37-1038)	X	X	X	X	X	X	X	-	-	-
5579	Brad No. 19 x 3/4 (Taper head)	X	X	X	X	X	X	X	-	-	-
5738	Brad No. 19 x 1/2 (Taper head)	X	X	X	X	X	X	X	-	-	-
233628	Buckram 8 oz.-38" wide-Black-single ply (Used on 1114-15)	-	-	X	X	-	-	-	-	-	-
312372	Button hold down tape (5-1/2" long) (White) ..	-	-	-	-	-	-	X	X	X	X
312373	Button hold down tape (6" long) (Yellow) ...	X	X	X	X	X	X	-	X	X	X
312374	Button hold down tape (8-3/4" long) (Purple) ..	-	X	X	-	X	X	-	-	X	X
233205	Button hold down tape (6-3/4" long) (Green) ..	X	X	X	X	-	-	X	X	X	X
233206	Button hold down tape (7-1/4" long) (Tan) ..	X	-	-	X	-	X	X	-	X	X
218001	Button No. 40 line upholsterers prong (Used on 1119)	-	-	-	-	-	-	-	X	-	-
113980	Carpet woolen 36" wide (Used on 1132-33-34- 35-36-27-53)	X	X	X	X	X	-	-	-	X	X
233269	Carpet woolen 44" wide (Used on 1137)	-	-	-	-	-	X	-	-	-	-
200996	Carpet rubber set 36" wide (Not used on 1153)	-	-	-	-	-	X	X	X	X	X
29651	Cloth cotton 36" wide	X	X	X	X	X	X	X	-	X	X
233267	Cloth cotton oiled 50" wide	X	X	X	X	X	X	X	-	-	-
29790	Cord window curtain guide	-	X	X	X	-	X	-	-	-	-
113822	Cord welt enameled drill	-	X	X	-	X	-	-	-	-	-
226983	Cord welt 11/16 x 3/16 leather natural grain	-	-	-	X	-	-	X	X	X	X
173243	Cord welt seaming lace 11/16 x 3/16 (Pattern Vogt No. 935) (Used on 1112-1103-13-14- 15-16-17-18)	X	X	X	X	X	X	X	-	-	-
233352	Cord welt seaming lace 11/16 paper cord 1/2" flange (Pattern Vogt No. 936) (Used on 1132-33-34-35-36-37-38)	X	X	X	X	X	X	X	-	-	-
127253	Cord welt seaming lace (Vogt No. 935) (Used on 1103-13-14-15-16-17-18)	X	X	X	X	X	X	X	-	-	-
243020	Cord welt 5/8 x 3/16 imitation leather (Antiqua Tan) (Used on 1103-12-13-14-15- 16-17-18-07-43)	X	X	X	X	X	X	X	-	X	X
243021	Cord welt 5/8 x 3/16 imitation leather (Walnut finish)	X	X	X	X	X	X	X	-	X	X
233940	Cord welt 3/16" twisted paper sheeting covered 1/2" flange (Used on 1103-12-13- 14-15-16-17)	X	X	X	X	X	X	-	-	-	-
243410	Cord welt-top material covered 3/16 paper cord 5/8" flange	-	-	-	-	-	-	-	X	X	X
169249	Drill sized plain 33" wide	-	X	X	-	X	-	-	-	X	-
161787	Drill white cotton 7 oz. 36" wide	X	X	X	X	X	X	X	X	X	X
306132	Fabric Osnaburg 50" wide	X	X	X	X	X	X	X	X	X	X
200467	Fabric top material (54" wide) water repellant treated	-	-	-	-	-	-	-	X	X	X
325089	Fabric upholstering 58" (Used on 1103-12-13- 14-15-16-17-18)	X	X	X	X	X	X	X	-	-	-
233853	Fabric upholstering (Used on 1153-27)	-	-	-	-	-	-	-	-	X	X
185211	Fabric 58" upholstering (Used on 1132-33- 34-35-36-37-38)	X	X	X	X	X	X	X	-	-	-

Piece No.	Name	(16th Series)									
		1112-1122 S P. Runabout Sedan	1103-1133 S P. Tour. Sedan	1114-1144 7 P. Tour. Sedan	1115-1125 7 P. Tour. Sedan Lim.	1116-1136 S P. Club Sedan	1117-1127 S P. Coupe	1118-1138 2-4 P. Coupe	1119-1139 2-4 P. Carry. Coupe	1143-1153 S P. Convert. Sedan	1167-1177 S P. Victoria
		No. Required									
226913	Fabric upholstery (Mohair 54" wide) (Used on 1112-1103-13-14-15-16-17-18-43-07)	x	x	x	x	x	x	x	x	x	x
113981	Fabric upholstery 58" wide 22 oz. body cloth (Used on 1112-1103-13-14-15-16-17-18-27-53)	x	x	x	x	x	x	x	x	x	x
115026	Fabric 60" upholstery side wall oz. (Used on 1112-1103-13-14-15-16-17-18)	x	x	x	x	x	x	x	x	x	x
184863	Fabric-roof covering 45" wide turtle grain (Black finish)	x	-	-	-	-	-	-	-	-	-
218169	Fabric-roof covering 45" wide Vox grain	x	x	x	x	x	x	x	x	x	x
218170	Fabric-roof covering 45" wide Vox grain	-	x	x	x	x	x	x	x	x	x
218128	Fabric-pyroxilin coated double faced window curtain (Used on 1112-1103-13-14-15-16-17-18)	x	x	x	x	x	x	x	x	x	x
195564	Fastener eyelet-top envelope	-	-	-	-	-	-	-	-	x	x
229579	Fastener eyelet washer—rear seat back strap	-	-	-	-	-	-	-	-	-	x
161794	Fastener single woodscrew post top envelope	-	-	-	-	-	-	-	-	x	x
227914	Fastener stud-top envelope	-	-	-	-	-	-	-	-	x	x
161792	Fastener washer-top envelope	-	-	-	-	-	-	-	-	x	x
229578	Fastener eyelet long-top rear curtain	-	-	-	-	-	-	-	x	x	x
229579	Fastener eyelet washer-top rear curtain	-	-	-	-	-	-	-	x	x	x
229777	Fastener stud woodscrew-top rear curtain (long single)	-	-	-	-	-	-	-	x	-	-
233797	Felt-black 2-3/8" wide 1/8" thick (Used on 1132-33-34-35-36-37-38)	x	x	x	x	x	x	x	x	-	-
233799	Felt 3/16 x 1" (black) partition	-	-	-	-	-	-	-	-	x	x
195338	Felt top bow filler	-	-	-	-	-	-	-	-	x	x
156857	Gimp 3/4 bias cut imitation leather	x	x	x	x	x	x	x	x	x	x
228406	Gimp 3/4 fabric top material	-	-	-	-	-	-	-	-	x	x
156692	Gimp (1/2" imitation black Colonial leather)	x	x	x	x	x	x	x	x	x	x
328447	Grommet No. 2 cushion screen	-	-	-	-	-	-	-	-	11	11
136832	Grommet No. 2 arm rest pocket	-	-	-	1	-	-	-	-	-	-
325448	Grommet washer-cushion screen	-	-	-	-	-	-	-	-	11	11
136832	Grommet No. 3 rumble seat back vent	-	-	-	-	-	-	5	5	-	-
136833	Grommet No. 2 washer arm rest pocket	-	-	-	1	-	-	-	-	-	-
136833	Grommet No. 3 washer-rumble seat back vent	-	-	-	-	-	-	5	5	-	-
214054	Hair interlaced 52" wide (Used on 1112-1103-13-14-15-35-16-17-18-19-39)	x	x	x	x	x	x	x	x	-	-
306188	Hog rings, Jenks and Muir or equivalent	x	x	x	-	x	x	-	-	-	-
314737	Hog ring (large)	x	x	x	x	x	x	x	x	x	x
214109	Leather imitation 52" wide Color Black	-	-	-	-	-	x	-	-	x	x
226917	Leather trimming (Natural grain)	-	-	-	x	-	x	x	x	x	x
226918	Leather imitation (Natural grain)	x	x	x	x	x	x	x	x	-	-
183986	Leather turtle grain landau 10 to 10-1/2 oz. (Black)	x	-	-	-	-	-	-	-	-	-
161778	Leather binding .020 thick (Used on 1133-34-35)	-	x	x	x	-	-	-	-	-	-
233624	Mat—rear compartment floor pan (Use with bodies 1117-1107) (Use with side wheel carrier)	-	-	-	-	-	1	-	-	-	1
235260	Mat—trunk compartment floor rubber (Used on 1116)	-	-	-	-	1	-	-	-	-	-
235259	Mat—trunk compartment floor rubber (Use with side wheel carrier) (Used on 1112-1103-13-14-15)	1	1	1	1	-	-	-	-	-	-

Piece No.	Name (16th Series)	No. Required									
		1112-1132 5 P. Formal Sedan	1103-13-33 5 P. Tour. Sedan	1114-34 7 P. Tour. Sedan	1115-35 7 P. Tour. Sedan Lim.	1116-36 5 P. Club Sedan	1117-37 5 P. Coupe	1118-38 2-4 P. Coupe	1119-39 2-4 P. Conv. Coupe	1143-53 5 P. Conv. Sedan	1107-27 5 P. Victoria
235258	Mat-trunk compartment floor rubber (Used on 1112-1103-13-14-15)	1	1	1	1	-	-	-	-	-	-
235268	Mat-trunk compartment floor rubber (Use with side wheel carrier) (Use on 1116)	-	-	-	-	1	-	-	-	-	-
192303	Muslin rubber 54" wide (Used on 1132-33-34-35-36-37-38-39-43-53-27)	x	x	x	x	x	x	x	x	x	x
306979	Printed Kersey 17 oz. 40" wide (Used on 1112-1103-13-14-15-16-17-07-43)	x	x	x	x	x	x	-	-	x	x
140935	Paperboard (1/2 x 48")	x	x	x	x	x	x	x	-	-	-
135117	Paperboard shim 1/16 x 1 x 36	x	x	x	x	x	x	x	-	-	-
182894	Papercord 1/4 twisted (Used on 1132-33-34-35-36-17-37-38-39)	x	x	x	x	x	x	x	-	-	-
211171	Plush high pile worsted (Used on 1132-33-34-35-36-37-1127-53)	x	x	x	x	x	x	-	-	x	x
224304	Rubber strip-door weatherstrip	x	x	x	x	x	x	x	x	x	x
228320	Rubber riser 1/2 half round	x	x	x	x	x	x	x	x	x	x
113983	Silk curtain 22" wide (Used on 1132-33-34-35-36-37-38)	x	x	x	x	x	x	x	-	-	-
175757	Snap fastener eyelet-top envelope	-	-	-	-	-	-	-	x	x	x
175757	Snap fastener eyelet-top side quarter	-	-	-	-	-	-	-	x	-	-
139150	Snap fastener socket (Mohair) carpet front floor (Used on 1112-1103-13-14-15-16-17-18-19-39-07-43)	x	x	x	x	x	x	x	x	x	x
115799	Snap fastener socket-carpet trunk compartment floor (Used on 1132-33-34-35)	x	x	x	x	-	-	-	-	-	-
137510	Snap fastener socket-cowl panel tab	x	x	x	x	x	x	x	-	x	x
115798	Snap fastener socket ring (short prong) carpet trunk compartment floor (Used on 1132-33-34-35)	x	x	x	x	-	-	-	-	-	-
200073	Snap fastener socket-rumble seat compartment floor carpet	-	-	-	-	-	-	x	x	-	-
139150	Snap fastener socket-top envelope	-	-	-	-	-	-	-	x	x	x
214974	Snap fastener socket-top side quarter	-	-	-	-	-	-	-	x	-	-
175757	Snap fastener eyelet (Mohair) carpet front floor (Used on 1112-1103-13-14-15-16-17-18-19-39-1107-43)	x	x	x	x	x	x	x	x	x	x
206744	Snap fastener stud (drive screw) carpet rear floor (Used on 1103-12-13-14-15-16-17-07-43)	x	x	x	x	x	x	-	-	x	x
185412	Snap fastener woodscrew stud-rear curtain to rear bow	-	-	-	-	-	-	-	-	x	x
185412	Snap fastener woodscrew stud-rear seat back strap	-	-	-	-	-	-	-	-	-	x
159060	Snap fastener stud (self tapping screw) carpet rear floor (Used on 1103-12-13-14-15-16-17-07-43)	1	1	1	1	1	1	-	-	1	1
112058	Snap fastener stud (woodscrew) (Used on 1132-33-34-35-36-37-1127-53)	x	x	x	x	x	x	-	-	x	x
193201	Snap fastener stud (drive screw) carpet front floor (Used on 1132-33-34-35-36-37-38-27-53)	x	x	x	x	x	x	x	-	x	x
193201	Snap fastener stud (drive screw) carpet trunk compartment floor (Used on 1132-33-34-35)	x	x	x	x	-	-	-	-	-	-
185412	Snap fastener woodscrew stud-top envelope ..	-	-	-	-	-	-	-	x	x	x

Piece No.	Name	(16th Series)									
		1112-1132 5 P. Formal Sedan	1103-13-33 5 P. Tour. Sedan	1114-34 7 P. Tour. Sedan	1115-35 7 P. Tour. Sedan Lim.	1116-36 5 P. Club Sedan	1117-37 5 P. Coupe	1118-38 2-4 P. Coupe	1119-39 2-4 P. Conv. Coupe	1143-93 5 P. Conv. Sedan	1107-27 5 P. Victoria
		No. Required									
206744	Snap fastener stud (drive screw) rumble seat compartment floor	-	-	-	-	-	-	X	X	-	-
139157	Snap fastener stud-top side quarter	-	-	-	-	-	-	-	X	-	-
175757	Snap fastener eyelet-carpet (Mohair) floor rear (Use on bodies 1103-12-13-14-15-16-17-07-43)	X	X	X	X	X	X	-	-	X	X
139150	Snap fastener socket carpet (Mohair) floor rear (Use on bodies 1103-12-13-14-15-16-17-07-43)	X	X	X	X	X	X	-	-	X	X
193200	Snap fastener stud (machine screw) carpet front floor (Used on 1132-33-34-35-36-37-38-27-53)	X	X	X	X	X	X	X	-	X	X
228144	Snap fastener stud (machine screw post) top.	-	-	-	-	-	-	-	X	-	-
193199	Snap fastener stud (rivet) carpet front floor (Used on 1132-33-34-35-36-37-38)	X	X	X	X	X	X	X	-	-	-
206657	Tacks-upholsters (Specify set number)	X	X	X	X	-	X	-	-	-	-
206656	Tacks-upholsters (Specify set number)	X	X	X	X	-	X	-	-	-	-
29637	Thread No. EE Spool silk	X	X	X	X	X	X	X	X	X	X
192345	Thread No. 18 linen	X	X	X	X	X	X	X	X	X	X
192346	Thread No. 25 linen	X	X	X	X	X	X	X	X	X	X
29638	Thread "A" Spool silk	X	X	X	X	X	X	X	X	X	X
29640	Thread No. EE No. 18 or Dean and Sheck No. 12-4	X	X	X	X	X	X	X	X	X	X
127808	Thread-Dean and Sheck No. 20-A silk finish	X	X	X	X	X	X	X	X	X	X
200638	Thread No. 80-3 hard finish cotton (Used on 1132-33-34-35-36-37-38)	X	X	X	X	X	X	X	-	-	-
200639	Thread No. 90-3 hard finish cotton (Used on 1132-23-33-34-35-36-37-38)	X	X	X	X	X	X	X	-	-	-
157022	Thread-Lincoln No. 6	X	X	X	X	X	X	X	X	X	X
157586	Thread No. 1201 cord	X	X	X	X	X	X	X	X	X	X
29625	Twine No. 252 Yazoo	X	X	X	X	X	X	X	X	X	X
29627	Wadding 32" blue sheet No. 532	X	X	X	X	X	X	X	X	X	X
325446	Wadding 4" rolled jute cotton cloth covered.	X	X	X	X	X	X	X	X	X	X
228446	Wadding white cotton rolled 4"	-	-	-	-	-	-	X	X	-	-
182687	Wadding 32" white unbleached No. 532 (Used on 1012-1003-13-14-15-16-17-18-19)	X	X	X	X	X	X	X	X	-	-
214213	Wadding 8" white cotton rolled (Used on 1115-18-19-07-43)	-	-	-	X	-	-	X	X	X	X
172470	Wadding 4" white cotton unbleached rolled	X	X	X	X	X	X	X	X	X	X
128040	Wadding 32" white sheet (Used on 1112-32-33-34-35-36-37-38-39-1107-27-43-53)	X	X	X	X	X	X	X	X	X	X
183741	Wadding roof 41" wide	X	X	X	X	X	X	X	-	-	-
193352	Wadding-elastic (1-1/2" wide)	-	-	-	-	-	-	X	X	X	-
233472	Webbing-elastic (1/2" wide) (Black)	-	X	X	-	X	-	-	-	-	-
62759	Webbing jute (3" wide)	-	-	X	X	-	-	-	X	X	X
214562	Windlace cloth (Pattern Vogt No. 935) (Specify set number) (Used on 1112-1103-13-14-15-16-17-18)	X	X	X	X	X	X	X	-	-	-
233355	Windlace cloth (Pattern Vogt No. 936) (Specify set number) (Used on 1132-33-34-35-36-37-38)	X	X	X	X	X	X	X	-	-	-
228407	Windlace leather (Natural grain)	-	-	-	-	-	-	-	X	X	X
226161	Wire No. 13 W. and M. Ga. (.0915)	-	X	X	X	-	X	-	-	-	-
233299	Wire No. 9 (.148)	-	X	X	-	X	-	-	-	-	-
229576	Zipper 12" long	-	-	-	-	-	-	-	2	-	-
328074	Zipper 13-3/4" long	-	-	-	-	-	-	-	-	2	2

[The page contains extremely faint and illegible text, likely bleed-through from the reverse side of the document. The text is too light to transcribe accurately.]

Piece No.	Name	(17th Series)									
		1232 5 P. Formal Sedan	1233 5 P. Tour. Sedan	1234 7 P. Tour. Sedan	1235 7 P. Tour. Sedan Lim	1236 5 P. Club Sedan	1237 5 P. Coupe	1238 2-4 P. Coupe	1239 2-4 P. Conv. Coupe	1243 5 P. Conv. Sedan	1247 5 P. Victoria
		No. Required									
BODY ATTACHING PARTS											
7886	Body to frame bolt No. (7/16-20 x 1-3/4 hex. hd.)	2	2	2	2	2	2	2	2	2	2
5282	Body to frame bolt No. 2 (7/16-20 x 3-1/2 hex. hd.)	2	2	2	2	2	2	2	2	2	2
235359	Body to frame bolt No. 2 (inside) (7/16-20 x 10-1/4 flat hd.)	-	-	-	-	-	-	-	2	2	2
5282	Body to frame bolt No. 3 (7/16-20 x 3-1/2 hex. hd.)	2	2	2	2	2	2	2	2	2	2
7954	Body to frame bolt No. 4 (7/16-20 x 3-1/4 hex. hd.)	-	-	-	-	-	2	2	2	-	2
7834	Body to frame bolt No. 4 (7/16-20 x 3-1/8 hex. hd.)	2	2	2	2	2	-	-	-	4	-
7954	Body to frame bolt No. 5 (7/16-20 x 3-1/4 hex. hd.)	4	4	4	4	4	4	4	4	-	4
7834	Body to frame bolt No. 5 (7/16-20 x 3-1/8 hex. hd.)	-	-	-	-	-	-	-	-	4	-
221547	Body to frame bolt No. 6 (7/16-20 x 5-5/8 hex. hd.)	2	2	2	2	2	2	2	2	2	2
7890	Body to frame bolt No. 7 (7/16-20 x 1-1/2 hex. hd.)	2	2	2	2	2	2	2	2	2	2
7890	Body to frame bolt No. 8 (7/16-20 x 1-1/2 hex. hd.)	2	2	2	2	2	2	2	2	2	2
131809	Body to frame bolt washer--large (7/16 special)	4	4	4	4	4	4	4	4	-	4
131801	Body to frame bolt washer--small 7/16 flat side	2	2	2	2	2	2	2	2	2	2
131046	Body to frame bolt washer--small (7/16 special)	26	26	26	26	24	24	24	24	28	24
185270	Body hold down bolt bracket liner (3/8" thick)	x	x	x	x	x	x	x	-	-	-
231975	Body hold down bolt bracket liner (1/8" thick)	-	-	-	-	-	-	-	x	x	x
5508	Body to frame bolt lockwasher 7/16	4	4	4	4	6	6	6	6	10	6
5806	Body to frame bolt lockwasher 7/16 (Shakeproof)	12	12	12	12	10	10	10	10	8	10
7007	Body to frame bolt nut 7/16-20	14	14	14	14	14	14	14	16	12	16
182439	Body to frame bolt nut lock	12	12	12	12	12	10	10	12	10	12
235416	Body to frame liner (1/16 thick)	-	-	-	-	-	-	-	x	x	x
185273	Body to frame liner (3/16 thick)	x	x	x	x	x	x	x	-	-	-
231975	Body to frame liner (1/8 thick)	-	x	-	-	-	x	-	x	x	x
185270	Body to frame liner (3/8 thick)	x	x	x	x	x	x	x	-	-	-
185274	Body to frame liner (1/4 thick)	x	x	x	x	x	x	x	-	-	-
226790	Body to frame liner (3/8 thick)	-	-	-	-	2	2	2	-	-	-
235397	Body to frame liner anti-squeak	-	-	-	-	-	-	-	x	x	x
308954	Body to frame liner shim--short (1/16 thick)	-	-	-	-	-	-	-	x	-	x
308953	Body to frame liner shim--short (1/8 thick)	-	-	-	-	-	-	-	4	-	4
235082	Body to frame liner--rear	1	1	1	1	-	-	-	-	-	-
235419	Body to frame liner--rear anti-squeak	-	-	-	-	-	-	-	4	-	4
185274	Body hold down bolt bracket liner (1/4 thick)	x	x	x	x	x	x	x	-	-	-
235416	Body hold down bolt bracket liner (1/16 thick)	-	-	-	-	-	-	-	x	x	x

Piece No.	Name	(17th Series)									
		1232 5 P. Formal Sedan	1233 5 P. Tour. Sedan	1234 7 P. Tour. Sedan	1235 7 P. Tour. Sedan Lim.	1236 5 P. Club Sedan	1237 5 P. Coupe	1238 2-4 P. Coupe	1239 2-4 P. Conv. Coupe	1243 5 P. Conv. Sedan	1247 5 P. Victoria
185273	Body hold down bolt bracket liner (3/16 thick)	X	X	X	X	X	X	X	-	-	-
235397	Body hold down bolt bracket liner anti-squeak	-	-	-	-	-	-	-	X	X	X

ANTI-RUMBLE AND ANTI-SQUEAK

184876	Anti-squeak compound	X	X	X	X	X	X	X	X	X	X
224775	Anti-squeak felt (1/4 x 2" wide strip)	X	X	X	X	X	-	-	-	-	-
181545	Anti-squeak tape 2"	X	X	X	X	X	X	X	X	X	X
51331	Anti-squeak tape 1-1/2"	X	X	X	X	X	X	X	X	X	X
39403	Anti-squeak tape 3/4"	X	X	X	X	X	X	X	X	X	X
328571	Body sealer--inner body	X	X	X	X	X	X	X	X	X	X
314440	Body sealer--under body	X	X	X	X	X	X	X	X	X	X

ARM REST

Always send samples of material when ordering trimmed assemblies, as the assemblies are upholstered to match the body interior.

233350	Arm rest (trimmed) assembly--right	1	-	-	-	-	-	-	-	-	-
233194	Arm rest (trimmed) assembly--right	-	1	-	-	-	-	-	-	-	-
233195	Arm rest (trimmed) assembly--left	-	1	-	-	-	-	-	-	-	-
233351	Arm rest (trimmed) assembly--left	1	-	-	-	-	-	-	-	-	-
244008	Arm rest (trimmed) assembly--right	-	-	-	-	-	-	-	-	-	1
244009	Arm rest (trimmed) assembly--left	-	-	-	-	-	-	-	-	-	1
244006	Arm rest (trimmed) assembly--right	-	-	-	-	-	-	-	-	1	-
244007	Arm rest (trimmed) assembly--left	-	-	-	-	-	-	-	-	1	-
233196	Arm rest (trimmed) assembly--right	-	-	1	-	-	-	-	-	-	-
233197	Arm rest (trimmed) assembly--left	-	-	1	-	-	-	-	-	-	-
233198	Arm rest (trimmed) assembly--right	-	-	-	1	-	-	-	-	-	-
233199	Arm rest (trimmed) assembly--left	-	-	-	1	-	-	-	-	-	-
233200	Arm rest (trimmed) assembly--right	-	-	-	-	1	-	-	-	-	-
233201	Arm rest (trimmed) assembly--left	-	-	-	-	1	-	-	-	-	-
233202	Arm rest (trimmed) assembly--right	-	-	-	-	-	1	-	-	-	-
233203	Arm rest (trimmed) assembly--left	-	-	-	-	-	1	-	-	-	-
231806	Arm rest ash tray trim block--cover plate .	-	2	2	2	-	2	-	-	-	-
6230	Arm rest attaching screw 1/4-28 x 11/16 flat hd.	2	2	2	2	4	-	-	-	-	-
193730	Arm rest attaching screw ferrule 1/4	2	2	2	2	4	-	-	-	-	-
224142	Arm rest attaching key hole plate--right ..	1	-	-	-	1	1	-	-	-	-
224320	Arm rest plate--right	1	-	-	-	-	-	-	-	-	-
224319	Arm rest plate--left	1	-	-	-	-	-	-	-	-	-
224143	Arm rest attaching key hole plate--left ...	1	-	-	-	1	1	-	-	-	-
231890	Arm rest cushion--right	-	-	-	-	-	1	-	-	-	-
235186	Arm rest cushion--right	1	-	-	-	-	-	-	-	-	-
231800	Arm rest cushion--right	-	1	-	-	-	-	-	-	-	-
224952	Arm rest cushion--left	-	-	-	-	1	-	-	-	-	-
231891	Arm rest cushion--left	-	-	-	-	-	1	-	-	-	-
235187	Arm rest cushion--left	1	-	-	-	-	-	-	-	-	-
231801	Arm rest cushion--left	-	1	-	-	-	-	-	-	-	-
231804	Arm rest cushion--right	-	-	1	1	-	-	-	-	-	-

Piece No.	Name	(17th Series)									
		1232 5 P. Formal Sedan	1233 5 P. Tour. Sedan	1234 7 P. Tour. Sedan	1235 7 P. Tour. Sedan Lim.	1236 5 P. Club Sedan	1237 5 P. Coupe	1238 2-4 P. Coupe	1239 2-4 P. Conv. Coupe	1253 5 P. Conv. Sedan	1227 5 P. Victoria
		No. Required									
226387	Arm rest cushion--right	-	-	-	-	1	-	-	-	-	-
231805	Arm rest cushion--left	-	-	1	1	-	-	-	-	-	-
243584	Arm rest cushion--right	-	-	-	-	-	-	-	-	1	-
243585	Arm rest cushion--left	-	-	-	-	-	-	-	-	1	-
243608	Arm rest cushion--right	-	-	-	-	-	-	-	-	-	1
243609	Arm rest cushion--left	-	-	-	-	-	-	-	-	-	1

ARM SLING

243974	Arm sling	2	2	2	2	2	2	-	-	-	-
243982	Arm sling bar assembly--right	1	-	-	-	-	-	-	-	-	-
243983	Arm sling bar assembly--left	1	-	-	-	-	-	-	-	-	-
243986	Arm sling bar assembly--right	-	1	-	-	-	-	-	-	-	-
243987	Arm sling bar assembly--left	-	1	-	-	-	-	-	-	-	-
243976	Arm sling bar assembly--right	-	-	1	1	-	-	-	-	-	-
243977	Arm sling bar assembly--left	-	-	1	1	-	-	-	-	-	-
245348	Arm sling bar assembly--right	-	-	-	-	1	-	-	-	-	-
245349	Arm sling bar assembly--left	-	-	-	-	1	-	-	-	-	-
245350	Arm sling bar assembly--right	-	-	-	-	-	1	-	-	-	-
245351	Arm sling bar assembly--left	-	-	-	-	-	1	-	-	-	-
243965	Arm sling bar attaching screw special	4	4	4	4	2	4	-	-	-	-
6797	Arm sling bar attaching screw No. 12 x 1-1/2 Phillips oval hd.	-	-	-	-	2	-	-	-	-	-
304059	Plain washer 13/32 x 1 x 1/16	4	4	4	4	2	4	-	-	-	-
187483	Arm sling bar attaching screw bushing	4	4	4	4	2	4	-	-	-	-

ASH TRAY

245086	Ash tray assembly--right	-	-	-	-	1	-	-	-	-	-
245087	Ash tray assembly--left	-	-	-	-	1	-	-	-	-	-
245080	Ash tray assembly	-	2	2	2	-	2	-	-	2	2
105029	Ash tray assembly spring dowel	-	-	-	-	2	-	-	-	-	-
235750	Ash tray (instrument board)	1	1	1	1	1	1	1	1	1	1
211026	Ash tray ash receiver	2	-	-	-	-	-	-	-	-	-
226306	Ash tray ash receiver	-	-	-	-	2	-	-	-	-	-
235264	Ash tray cigar lighter (complete)	2	-	-	-	2	-	-	-	-	-
235263	Ash tray cigar lighter (complete)	-	2	2	2	-	-	-	-	-	-
235262	Ash tray cigar lighter (complete)	-	-	-	-	-	2	-	-	-	-
236653	Ash tray cigar lighter base	-	-	-	-	-	-	-	-	1	1
235271	Ash tray cigar lighter base	2	-	-	-	2	-	-	-	-	-
235270	Ash tray cigar lighter base	-	2	2	2	-	-	-	-	-	-
235269	Ash tray cigar lighter base	-	-	-	-	-	2	-	-	-	-
235266	Ash tray cigar lighter (knob and tip)	2	2	2	2	2	2	-	-	1	1
0239616	Ash tray cigar lighter tip	2	2	2	2	2	2	-	-	1	1
245084	Ash tray cover plate--right	1	-	-	-	-	-	-	-	-	-
245085	Ash tray cover plate--left	1	-	-	-	-	-	-	-	-	-

DASH

235605	Dash panel assembly	1	1	1	1	1	1	1	1	1	1
199045	Clinch nut 1/4-28 thread	15	15	15	15	15	15	15	15	15	15
224072	Clinch nut 5/16-24 thread	1	1	1	1	1	1	1	1	1	1
235792	Dash panel bonnet dash liner--side	2	2	2	2	2	2	2	2	2	2

Piece No.	Name	(17th Series)									
		1232 5 P. Formal Sedan	1233 5 P. Tour. Sedan	1234 7 P. Tour. Sedan	1235 7 P. Tour. Sedan Lim.	1236 5 P. Club Sedan	1237 5 P. Coupe	1238 2-4 P. Coupe	1239 2-4 P. Conv. Coupe	1253 5 P. Conv. Sedan	1227 5 P. Victoria
		No. Required									
235791	Dash panel bonnet dash liner--top	2	2	2	2	2	2	2	2	2	2
228260	Dash panel bonnet dash liner hook	4	4	4	4	4	4	4	4	4	4
229340	Washer 3/16 special	4	4	4	4	4	4	4	4	4	4
7002	Nut No. 8-32 thread	4	4	4	4	4	4	4	4	4	4
228251	Dash panel bonnet dash liner hook saddle ..	4	4	4	4	4	4	4	4	4	4
187803	Dash panel bonnet dash liner staple 3/4" long	4	4	4	4	4	4	4	4	4	4
228284	Dash panel bonnet dash liner staple weatherstrip	x	x	x	x	x	x	x	x	x	x
228246	Dash panel bonnet dash liner staple saddle.	4	4	4	4	4	4	4	4	4	4
235754	Dash panel inter-liner	1	1	1	1	1	1	1	1	1	1
245370	Dash panel liner assembly	1	1	1	1	1	1	1	1	1	1
111074	Dash panel liner snap fastener stud (eyelet type)	7	7	7	7	7	7	7	7	7	7
123094	Dash panel liner snap fastener stud (eyelet)	7	7	7	7	7	7	7	7	7	7
5317	Dash panel liner screw 1/4-28 x 1-1/8 hex. hd.	2	2	2	2	2	2	2	2	2	2
5502	Lockwasher 1/4	2	2	2	2	2	2	2	2	2	2
62065	Washer 1/4 plain	1	1	1	1	1	1	1	1	1	1
220976	Dash panel to sill screw 5/16-24 x 4-1/4 hex. hd.	2	2	2	2	2	2	2	2	2	2
5504	Lockwasher 5/16	2	2	2	2	2	2	2	2	2	2
325790	Dash panel hole plug 3/4" dia. (Used on all cars not equipped with heater)	x	x	x	x	x	x	x	x	x	x
325789	Dash panel hole plug 7/16" dia. (Used on cars not equipped with radio and heaters)	x	x	x	x	x	x	x	x	x	x

DOOR

All doors must be adjusted to each respective body. To obtain satisfactory replacement of doors, it is advisable to return the damaged door to be repaired, if possible. If this cannot be done, the customer assumes the responsibility of the new door being a satisfactory fit. Specify on all orders the upholstery material, color and striping.

0337958	Door front right trimmed assembly	-	-	-	-	1	-	-	-	-	-
0337956	Door front right trimmed assembly	1	1	1	-	-	-	-	-	-	-
0337960	Door front right trimmed assembly	-	-	-	1	-	-	-	-	-	-
0337964	Door front right trimmed assembly	-	-	-	-	-	1	-	-	-	-
0337980	Door front right trimmed assembly	-	-	-	-	-	-	1	-	-	-
0337966	Door front right trimmed assembly	-	-	-	-	-	-	-	1	-	-
0337962	Door front right trimmed assembly	-	-	-	-	-	-	-	-	-	1
0337968	Door front right trimmed assembly	-	-	-	-	-	-	-	-	1	-
0337963	Door front left trimmed assembly	-	-	-	-	-	-	-	-	-	1
0337969	Door front left trimmed assembly	-	-	-	-	-	-	-	-	1	-
0337959	Door front left trimmed assembly	-	-	-	-	1	-	-	-	-	-
0337957	Door front left trimmed assembly	1	1	1	-	-	-	-	-	-	-
0337961	Door front left trimmed assembly	-	-	-	1	-	-	-	-	-	-
0337965	Door front left trimmed assembly	-	-	-	-	-	1	-	-	-	-
0337981	Door front left trimmed assembly	-	-	-	-	-	-	1	-	-	-
0337967	Door front left trimmed assembly	-	-	-	-	-	-	-	1	-	-

Piece No.	Name	(17th Series)									
		1232 5 P. Formal Sedan	1233 5 P. Tour. Sedan	1234 7 P. Tour. Sedan	1235 7 P. Tour. Sedan Lim	1236 5 P. Club Sedan	1237 5 P. Coupe	1238 2 4 P. Coupe	1239 2 4 P. Conv. Coupe	1253 5 P. Conv. Sedan	1227 5 P. Victoria
		No. Required									
0337973	Door rear left trimmed assembly	1	-	-	-	-	-	-	-	-	-
0337977	Door rear left trimmed assembly	-	1	-	-	-	-	-	-	-	-
0337975	Door rear left trimmed assembly	-	-	1	1	-	-	-	-	-	-
0337979	Door rear left trimmed assembly	-	-	-	-	1	-	-	-	-	-
0337971	Door rear left trimmed assembly	-	-	-	-	-	-	-	-	1	-
0337970	Door rear right trimmed assembly	-	-	-	-	-	-	-	-	1	-
0337972	Door rear right trimmed assembly	1	-	-	-	-	-	-	-	-	-
0337976	Door rear right trimmed assembly	-	1	-	-	-	-	-	-	-	-
0337974	Door rear right trimmed assembly	-	-	1	1	-	-	-	-	-	-
0337978	Door rear right trimmed assembly	-	-	-	-	1	-	-	-	-	-

DOOR ARM REST

Always send samples of material when ordering trimmed assemblies, as the assemblies are upholstered to match the body interior.

233384	Door arm rest (trimmed) assembly--right ...	1	1	1	-	1	1	1	-	-	-
233385	Door arm rest (trimmed) assembly--left	1	1	1	-	1	1	1	-	-	-
233382	Door arm rest (trimmed) assembly--right ...	-	-	-	1	-	-	-	1	1	1
233383	Door arm rest (trimmed) assembly--left	-	-	-	1	-	-	-	1	1	1
231970	Door arm rest cushion--right	1	1	1	1	1	1	1	1	1	1
231971	Door arm rest cushion--left	1	1	1	1	1	1	1	1	1	1
231972	Door arm rest support--right	1	1	1	1	1	1	1	1	1	1
231973	Door arm rest support--left	1	1	1	1	1	1	1	1	1	1
231976	Door arm rest support trim stick	2	2	2	2	2	2	2	2	2	2

DOOR PARTS

308103	Front door anti-rattler--upper 1/4"	2	2	2	2	2	2	2	-	-	-
308102	Front door anti-rattler--upper 3/16"	2	2	2	2	2	2	2	-	-	-
199167	Front door anti-rattler--lower	2	2	2	2	2	2	2	2	2	2
218305	Front door anti-rattler shim	x	x	x	x	x	x	x	x	x	x
185602	Front door bumper (1-9/32)	x	x	x	x	x	x	x	x	x	x
185601	Front door bumper (1-11/32)	x	x	x	x	x	x	x	x	x	x
185600	Front door bumper (1-13/32)	x	x	x	x	x	x	x	x	x	x
218685	Front door bumper (1-15/32)	x	x	x	x	x	x	x	x	x	x
236688	Front door diagonal brace	-	-	-	-	-	-	-	2	-	2
236732	Front door diagonal brace--right	-	-	-	-	-	-	-	-	1	-
236733	Front door diagonal brace--left	-	-	-	-	-	-	-	-	1	-
235046	Front door dovetail--male	2	2	2	2	2	2	2	4	4	4
6727	Front door dovetail--male screw 1/4-28 x 1-1/2 flat hd.	-	-	-	-	-	-	-	8	8	8
235042	Front door dovetail--female (single)	2	2	2	2	2	2	2	-	-	-
235559	Front door dovetail--female (double)	-	-	-	-	-	-	-	2	2	2
6836	Screw 1/4-20 x 1' oval hd.	-	-	-	-	-	-	-	-	6	-
229986	Front door hinge lower--right	1	1	1	1	1	1	1	-	-	-
230578	Front door hinge lower--right	-	-	-	-	-	-	-	1	1	1
229987	Front door hinge lower--left	1	1	1	1	1	1	1	-	-	-
230579	Front door hinge lower--left	-	-	-	-	-	-	-	1	1	1
6672	Screw 1/4-28 x 4-1/8 oval hd.	4	4	4	4	4	4	4	-	-	-
236062	Screw 5/16-24 x 5 flat hd. special ...	-	-	-	-	-	-	-	4	4	4
6449	Screw 1/4-28 x 2-3/8 flat hd.	4	4	4	4	4	4	4	-	-	-

Piece No.	Name (17th Series)	No. Required								
		1232 5 P. Formal Sedan	1233 5 P. Tour. Sedan	1234 7 P. Tour. Sedan	1235 7 P. Tour. Sedan Lim.	1236 5 P. Club Sedan	1237 5 P. Coupe	1238 2-4 P. Coupe	1239 2-4 P. Conv. Coupe	1253 5 P. Conv. Sedan
236060	Screw 5/16-24 x 2 flat hd. special ...	-	-	-	-	-	-	2	2	2
236061	Screw 5/16-24 x 2-1/2 flat hd. special	-	-	-	-	-	-	2	2	2
5899	Lockwasher 5/16 countersunk (Shakeproof)	-	-	-	-	-	-	16	16	16
184692	Screw boss 1/4-28 (Floating nut type).	4	4	4	4	4	4	-	-	-
229988	Front door hinge upper right assembly	1	1	1	1	1	1	1	1	1
229989	Front door hinge upper left assembly	1	1	1	1	1	1	1	1	1
6449	Screw 1/4-28 x 2-3/8 flat hd.	8	8	8	8	8	8	6	6	6
5747	Screw 1/4-28 x 1-5/8 flat hd.	-	-	-	-	-	-	2	2	2
5899	Lockwasher 5/16 countersunk (Shakeproof)	8	8	8	8	8	8	8	8	8
7819	Screw 3/8-24 x 1 hex. hd.	6	6	6	6	6	6	6	6	6
5506	Lockwasher 3/8	6	6	6	6	6	6	6	6	6
310588	Front door hinge upper assembly stop bumper	2	2	2	2	2	2	2	2	2
4927	Screw No. 8 x 7/8 rnd. hd.	2	2	2	2	2	2	2	2	2
235141	Front door hinge upper bracket liner	2	2	2	2	2	2	2	2	2
310576	Front door hinge upper pin	2	2	2	2	2	2	2	2	2
235956	Front door hinge upper pin bushing	4	4	4	4	4	4	4	4	4
231820	Front door hinge lower pin	2	2	2	2	2	2	-	-	-
230588	Front door hinge lower pin	-	-	-	-	-	-	2	2	2
231821	Front door hinge lower pin screw	2	2	2	2	2	2	2	2	2
5500	Lockwasher No. 10	2	2	2	2	2	2	2	2	2
183171	Front door lock--left	1	1	1	1	1	1	1	1	1
183170	Front door lock--right	1	1	1	1	1	1	1	1	1
5829	Screw No. 10-32 x 7/8 flat hd.	4	4	4	4	4	4	-	-	-
8207	Screw No. 10-32 x 3/4 flat hd.	-	-	-	-	-	-	2	2	2
8224	Screw No. 10-32 x 5/8 flat hd.	-	-	-	-	-	-	4	4	4
5491	Lockwasher 3/16 countersunk (Shakeproof)	4	4	4	4	4	4	6	6	6
8022	Screw No. 10-32 x 3/8 oval hd.	-	-	-	-	-	-	4	4	4
235100	Front door lock board attaching plate	4	4	4	4	4	4	-	-	-
6698	Front door lock board attaching screw No. 12-24 x 7/8 flat hd.	-	-	-	-	-	-	6	6	6
235255	Front door lock board attaching screw countersunk washer 1/4 special	-	-	-	-	-	-	14	14	14
245187	Front door lock handle--right (With key lock)	1	1	1	1	1	1	-	-	-
245190	Front door lock handle--left	1	1	1	1	1	1	-	-	-
245188	Front door lock handle--right (With key lock)	-	-	-	-	-	-	1	-	1
245189	Front door lock handle--right (With key lock)	-	-	-	-	-	-	-	1	-
245192	Front door lock handle--left	-	-	-	-	-	-	-	1	-
245191	Front door lock handle--left	-	-	-	-	-	-	1	-	1
337017	Front door lock handle cylinder lock	1	1	1	1	1	1	1	1	1
6775	Front door lock handle screw No. 12-24 x 7/16 (Phillips) rnd. hd.	2	2	2	2	2	2	2	2	2
6719	Front door lock handle screw lockwasher No. 12 (Shakeproof)	2	2	2	2	2	2	2	2	2
337638	Front door lock handle gasket	2	2	2	2	2	2	2	2	2
227518	Front door lock pillar finishing plate--rt.	-	-	-	-	-	-	1	-	1
227519	Front door lock pillar finishing plate--lt.	-	-	-	-	-	-	1	-	1
236728	Front door lock pillar finishing plate--rt.	-	-	-	-	-	-	-	1	-
236729	Front door lock pillar finishing plate--lt.	-	-	-	-	-	-	-	1	-
6905	Screw No. 4-40 x 3/8 oval hd.	-	-	-	-	-	-	4	6	4

Piece No.	Name	(17th Series)									
		1232 5 P. Formal Sedan	1233 5 P. Tour. Sedan	1234 7 P. Tour. Sedan	1235 7 P. Tour. Sedan Lim.	1236 5 P. Club Sedan	1237 5 P. Coupe	1238 2-4 P. Coupe	1239 2-4 P. Conv. Coupe	1253 5 P. Conv. Sedan	1227 5 P. Victoria
		No. Required									
231554	Front door lock remote control--right	1	1	1	1	1	1	1	1	1	1
236716	Front door lock remote control--right	1	1	1	1	1	1	1	1	1	1
236040	Front door lock remote control--right	1	1	1	1	1	1	1	1	1	1
231555	Front door lock remote control--left	1	1	1	1	1	1	1	1	1	1
236717	Front door lock remote control--left	1	1	1	1	1	1	1	1	1	1
236041	Front door lock remote control--left	1	1	1	1	1	1	1	1	1	1
231556	Front door lock remote control--right	1	1	1	1	1	1	1	1	1	1
231557	Front door lock remote control--left	1	1	1	1	1	1	1	1	1	1
8207	Screw No. 10-32 x 3/4 flat hd.							4	4	4	4
245197	Front door lock remote control handle	2	2	2	2	2	2	2	2	2	2
245186	Front door lock remote control handle escutcheon plate	2	2	2	2	2	2	2	2	2	2
133264	Front door lock remote control handle escutcheon plate spring	2	2	2	2	2	2	2	2	2	2
133339	Front door lock remote control handle insert	2	2	2	2	2	2	2	2	2	2
132972	Front door lock remote control handle pin	2	2	2	2	2	2	2	2	2	2
229996	Front door lock striker	2	2	2	2	2	2	2	2	2	2
6835	Screw No. 12-24 x 7/8 flat hd.								4		
241136	Front door panel assembly--right	1	1	1	1	1	1	1	1	1	1
241137	Front door panel assembly--left	1	1	1	1	1	1	1	1	1	1
241138	Front door panel assembly--right	1	1	1	1	1	1	1	1	1	1
241139	Front door panel assembly--left	1	1	1	1	1	1	1	1	1	1
241142	Front door panel assembly--right	1	1	1	1	1	1	1	1	1	1
241144	Front door panel assembly--right	1	1	1	1	1	1	1	1	1	1
241143	Front door panel assembly--left	1	1	1	1	1	1	1	1	1	1
241145	Front door panel assembly--left	1	1	1	1	1	1	1	1	1	1
241146	Front door panel assembly--right	1	1	1	1	1	1	1	1	1	1
241140	Front door panel assembly--right	1	1	1	1	1	1	1	1	1	1
241147	Front door panel assembly--left	1	1	1	1	1	1	1	1	1	1
241141	Front door panel assembly--left	1	1	1	1	1	1	1	1	1	1
235622	Front door truss assembly	2	2	2	2	2	2	2	2	2	2
235029	Front door truss assembly	2	2	2	2	2	2	2	2	2	2
241283	Front door weatherstrip 19" long	2	2	2	2	2	2	2	2	2	2
241284	Front door weatherstrip 98" long	2	2	2	2	2	2	2	2	2	2
314936	Front door weatherstrip clip	x	x	x	x	x	x	x	x	x	x
235958	Front door weatherstrip upper hinge--right	1	1	1	1	1	1	1	1	1	1
235959	Front door weatherstrip upper hinge--left	1	1	1	1	1	1	1	1	1	1
228239	Front door window to center removable pillar weatherstrip (Black)									x	
228238	Front door window to center removable pillar weatherstrip (Tan)									x	
227842	Front door window to center removable pillar weatherstrip retainer--right									1	
227843	Front door window to center removable pillar weatherstrip retainer--left									1	
245094	Front door window finishing moulding--right									1	
245095	Front door window finishing moulding--left									1	
245096	Front door window finishing moulding--right									1	
245097	Front door window finishing moulding--left									1	
245070	Front door window finishing moulding--right					1					
245071	Front door window finishing moulding--left					1					
245078	Front door window finishing moulding--right	1	1	1	1	1	1	1	1	1	1
245079	Front door window finishing moulding--left	1	1	1	1	1	1	1	1	1	1
245076	Front door window finishing moulding--right							1			
245077	Front door window finishing moulding--left							1			

Piece No.	Name	(17th Series)									
		1232 9 P. Formal Sedan	1233 5 P. Tour. Sedan	1234 7 P. Tour. Sedan	1235 7 P. Tour. Sedan Lim.	1236 9 P. Club Sedan	1237 5 P. Coupe	1238 2-4 P. Coupe	1239 2-4 P. Conv. Coupe	1253 5 P. Conv. Sedan	1227 5 P. Victoria
		No. Required									
235771	Front door window finishing moulding wood-screw ferrule No. 6	x	x	x	x	x	x	x	x	x	x
228239	Front door window to folding pillar weatherstrip (Black)	-	-	-	-	-	-	-	x	-	x
228238	Front door window to folding pillar weatherstrip (Tan)	-	-	-	-	-	-	-	x	-	x
227852	Front door window to folding pillar weatherstrip retainer--right	-	-	-	-	-	-	-	1	-	1
227853	Front door window to folding pillar weatherstrip retainer--left	-	-	-	-	-	-	-	1	-	1
228239	Front door window to front pillar weatherstrip (Black)	-	-	-	-	-	-	-	x	x	x
228238	Front door window to front pillar weatherstrip (Tan)	-	-	-	-	-	-	-	x	x	x
227840	Front door window to front pillar weatherstrip retainer--right	-	-	-	-	-	-	-	1	1	1
227841	Front door window to front pillar weatherstrip retainer--left	-	-	-	-	-	-	-	1	1	1
6460	Screw No. 8-32 x 3/8 flat hd.	-	-	-	-	-	-	-	6	6	6
220624	Front door window glass	-	-	-	-	2	-	-	-	-	-
220634	Front door window glass	2	2	2	2	-	2	-	-	-	-
228375	Front door window glass	-	-	-	-	-	-	2	-	-	-
236627	Front door window glass	-	-	-	-	-	-	-	2	-	2
227700	Front door window glass	-	-	-	-	-	-	-	2	-	2
230590	Front door window glass and frame assembly--right	-	-	-	-	-	-	-	1	-	1
230591	Front door window glass and frame assembly--left	-	-	-	-	-	-	-	1	-	1
236636	Front door window glass and frame assembly--right	-	-	-	-	-	-	-	-	1	-
236637	Front door window glass and frame assembly--left	-	-	-	-	-	-	-	-	1	-
230555	Front door window glass and frame assembly belt anti-rattler	-	-	-	-	-	-	-	2	-	2
236001	Front door window glass and frame assembly belt anti-rattler	-	-	-	-	-	-	-	-	2	-
308133	Screw No. 6 x 1/2 flat hd. (Parker Kalon) Type A	-	-	-	-	-	-	-	16	16	16
0243910	Front door window glass frame--right	-	-	-	-	-	-	-	1	-	1
0243911	Front door window glass frame--left	-	-	-	-	-	-	-	1	-	1
0243931	Front door window glass frame--right	-	-	-	-	-	-	-	-	1	-
0243932	Front door window glass frame--left	-	-	-	-	-	-	-	-	1	-
0243914	Front door window glass cushion--bottom	-	-	-	-	-	-	-	1	1	1
0243915	Front door window glass cushion--upper	-	-	-	-	-	-	-	1	1	1
236002	Front door window glass frame guide--right	-	-	-	-	-	-	-	1	-	1
236196	Front door window glass frame guide--right	-	-	-	-	-	-	-	-	1	-
236003	Front door window glass frame guide--left	-	-	-	-	-	-	-	1	-	1
236197	Front door window glass frame guide--left	-	-	-	-	-	-	-	-	1	-
5701	Screw 1/4-28 x 9/16 flat hd.	-	-	-	-	-	-	-	6	6	6
228239	Front door window to header weatherstrip (Black)	-	-	-	-	-	-	-	x	x	x
228238	Front door window to header weatherstrip (Tan)	-	-	-	-	-	-	-	x	x	x
236976	Front door window to header weatherstrip retainer--right	-	-	-	-	-	-	-	1	-	1

Piece No.	Name	(17th Series)									
		1232 5 P. Formal Sedan	1233 5 P. Tour. Sedan	1234 7 P. Tour. Sedan	1235 7 P. Tour. Sedan Lim.	1236 5 P. Club Sedan	1237 5 P. Coupe	1238 2-4 P. Coupe	1239 2-4 P. Conv. Coupe	1253 5 P. Conv. Sedan	1227 5 P. Victoria
		No. Required									
236977	Front door window to header weatherstrip retainer--left	-	-	-	-	-	-	-	1	-	1
236978	Front door window to header weatherstrip retainer--right	-	-	-	-	-	-	-	-	1	-
236979	Front door window to header weatherstrip retainer--left	-	-	-	-	-	-	-	1	-	-
6460	Screw No. 8-32 x 3/8 flat hd.	-	-	-	-	-	-	6	6	6	-
220626	Front door window lifter assembly--right	-	-	-	-	1	-	-	-	-	-
220627	Front door window lifter assembly--left	-	-	-	-	1	-	-	-	-	-
220628	Front door window lifter assembly--right	1	1	1	1	-	1	1	-	-	-
220629	Front door window lifter assembly--left	1	1	1	1	-	1	1	-	-	-
0243912	Front door window lifter assembly--right	-	-	-	-	-	-	-	1	-	1
0243913	Front door window lifter assembly--left	-	-	-	-	-	-	-	1	-	1
0243933	Front door window lifter assembly--right	-	-	-	-	-	-	-	1	-	-
0243934	Front door window lifter assembly--left	-	-	-	-	-	-	-	1	-	-
220622	Front door window lifter bumper	-	-	-	-	2	-	-	-	-	-
220640	Front door window lifter bumper	2	2	2	2	-	2	2	-	-	-
235166	Front door window regulator assembly--right	-	-	-	-	1	-	-	-	-	-
235167	Front door window regulator assembly--left	-	-	-	-	1	-	-	-	-	-
231552	Front door window regulator assembly--right	1	1	1	1	-	1	1	-	-	-
231553	Front door window regulator assembly--left	1	1	1	1	-	1	1	-	-	-
236014	Front door window regulator assembly--right	-	-	-	-	-	-	-	1	1	1
236015	Front door window regulator assembly--left	-	-	-	-	-	-	-	1	1	1
8214	Screw 1/4-28 x 3/4 flat hd.	8	8	8	8	8	8	8	-	-	-
6551	Screw 1/4-20 x 3/4 flat hd.	-	-	-	-	-	-	-	10	10	10
236012	Front door window regulator assembly to lock board washer	-	-	-	-	-	-	-	10	10	10
227371	Front door window regulator arm stop	-	-	-	-	-	-	-	2	2	2
245194	Front door window regulator handle	2	2	2	2	2	2	2	2	2	2
331591	Front door window regulator handle washer	2	2	2	2	2	2	2	2	2	2
245186	Front door window regulator handle escutcheon plate	2	2	2	2	2	2	2	2	2	2
133264	Front door window regulator handle escutcheon plate spring	2	2	2	2	2	2	2	2	2	2
133339	Front door window regulator handle insert	2	2	2	2	2	2	2	2	2	2
132972	Front door window regulator handle pin	2	2	2	2	2	2	2	2	2	2
227656	Front door window regulator lock board cam--right	-	-	-	-	-	-	-	1	1	1
227657	Front door window regulator lock board cam--left	-	-	-	-	-	-	-	1	1	1
0243922	Front door window runway--front upper	-	-	-	-	-	-	-	1	1	1
0243923	Front door window runway--front lower	-	-	-	-	-	-	-	1	1	1
220693	Front door window runway (front lower)	2	2	2	2	2	2	2	-	-	-
175763	Screw No. 4 x 3/8 flat hd. (Parker Kalon)	4	4	4	4	4	4	4	-	-	-
220694	Front door window runway (front upper)	2	2	2	2	2	2	2	-	-	-
6347	Screw No. 8-32 x 1/4 flat hd.	4	4	4	4	4	4	4	-	-	-
220695	Front door window runway (rear lower)	2	2	2	2	2	2	2	-	-	-
220689	Front door window runway (rear upper)	-	-	-	-	2	-	-	-	-	-
220698	Front door window runway (rear upper)	2	2	2	2	-	2	-	-	-	-
228330	Front door window runway (rear upper)	-	-	-	-	-	2	-	-	-	-
231966	Front door window runway retainer assembly--front right	1	1	1	1	1	1	1	-	-	-
231967	Front door window runway retainer assembly--front left	1	1	1	1	1	1	1	-	-	-

Piece No.	Name	(17th Series)									
		1232 5 P. Formal Sedan	1233 5 P. Tour. Sedan	1234 7 P. Tour. Sedan	1235 7 P. Tour. Sedan Lim.	1236 5 P. Club Sedan	1237 5 P. Coupe	1238 2-4 P. Coupe	1239 2-4 P. Conv. Coupe	1253 5 P. Conv. Sedan	1257 5 P. Victoria
		No. Required									
153168	Front door window runway retainer--rear ...	2	2	2	2	2	2	2	1	1	1
136008	Front door window runway shim 1/32 x 1/2 x 40" ...	x	x	x	x	x	x	x	-	-	-
132429	Front door window runway shim 1/16 x 1/2 x 40" ...	x	x	x	x	x	x	x	-	-	-
131316	Front door window stop block bumper	2	2	2	2	2	2	2	-	-	-
227887	Front door window stop bumper	-	-	-	-	-	-	-	2	2	2
8224	Screw No. 10-32 x 5/8 flat hd.	-	-	-	-	-	-	-	2	2	2
227385	Front door window stop bumper bracket	-	-	-	-	-	-	-	2	2	2
220653	Front door window wing assembly--left	1	1	1	1	1	1	1	-	-	-
220652	Front door window wing assembly--right	1	1	1	1	1	1	1	-	-	-
236862	Front door window wing assembly--right	-	-	-	-	-	-	-	1	1	1
236863	Front door window wing assembly--left	-	-	-	-	-	-	-	1	1	1
6448	Screw 1/4-20 x 3/4 hex. hd.	4	4	4	4	4	4	4	-	-	-
5447	Lockwasher 1/4 (Shakeproof)	4	4	4	4	4	4	4	-	-	-
220620	Front door window wing glass	2	2	2	2	2	2	2	-	-	-
236864	Front door window wing glass	-	-	-	-	-	-	-	2	2	2
228272	Front door window wing glass cushion	x	x	x	x	x	x	x	-	-	-
211649	Front door window wing glass cushion	x	x	x	x	x	x	x	-	-	-
229324	Front door window wing glass cushion	x	x	x	x	x	x	x	-	-	-
0243916	Front door window wing glass frame and pivot--right	-	-	-	-	-	-	-	1	1	1
0243917	Front door window wing glass frame and pivot--left	-	-	-	-	-	-	-	1	1	1
0328866	Front door window wing glass and retainer assembly--right	-	-	-	-	-	-	-	1	1	1
0328865	Front door window wing glass and retainer assembly--left	-	-	-	-	-	-	-	1	1	1
220625	Front door window wing glass and retainer assembly	2	2	2	2	2	2	2	-	-	-
220618	Front door window wing glass retainer front assembly	2	2	2	2	2	2	2	-	-	-
220633	Front door window wing glass retainer rear assembly	2	2	2	2	2	2	2	-	-	-
212366	Front door window wing glass retainer screw No. 4 x 3/16 (Parker Kalon) Type Z special hd.	4	4	4	4	4	4	4	-	-	-
220575	Front door window wing glass retainer pivot lower	2	2	2	2	2	2	2	-	-	-
220600	Front door window wing glass retainer pivot lower spacer	x	x	x	x	x	x	x	-	-	-
211409	Front door window wing glass retainer pivot--upper	2	2	2	2	2	2	2	-	-	-
212490	Front door window wing glass retainer pivot--upper--spring	2	2	2	2	2	2	2	-	-	-
0243918	Front door window wing regulator assembly--right	-	-	-	-	-	-	-	1	1	1
0243919	Front door window wing regulator assembly--left	-	-	-	-	-	-	-	1	1	1
220641	Front door window wing regulator assy.--rt.	1	1	1	1	1	1	1	-	-	-
220642	Front door window wing regulator assy.--lt.	1	1	1	1	1	1	1	-	-	-
7837	Screw 1/4-20 x 7/8 hex. hd.	4	4	4	4	4	4	4	-	-	-
5502	Lockwasher 1/4	4	4	4	4	4	4	4	-	-	-
245195	Front door window wing regulator handle ...	2	2	2	2	2	2	2	2	2	2

Piece No.	Name	(17th Series)									
		1232 5 P. Formal Sedan	1233 5 P. Tour. Sedan	1234 7 P. Tour. Sedan	1235 7 P. Tour. Sedan Lim.	1236 5 P. Club Sedan	1237 5 P. Coupe	1238 2-4 P. Coupe	1239 2-4 P. Conv. Coupe	1253 5 P. Conv. Sedan	1227 5 P. Victoria
		No. Required									
331591	Front door window wing regulator handle washer	2	2	2	2	2	2	2	2	2	2
147910	Front door window wing regulator handle screw	2	2	2	2	2	2	2	2	2	2
245193	Front door window wing regulator handle escutcheon plate	2	2	2	2	2	2	2	2	2	2
133339	Front door window wing regulator handle insert	2	2	2	2	2	2	2	2	2	2
235656	Front door window wing water deflector--rt.	1	1	1	1	1	1	1	-	-	-
235657	Front door window wing water deflector--lt.	1	1	1	1	1	1	1	-	-	-
220650	Front door window wing weatherstrip assembly--right	1	1	1	1	1	1	1	-	-	-
220651	Front door window wing weatherstrip assembly--left	1	1	1	1	1	1	1	-	-	-
0227830	Front door window wing weatherstrip assembly--rear right	-	-	-	-	-	-	-	1	1	1
0227831	Front door window wing weatherstrip assembly--rear left	-	-	-	-	-	-	-	1	1	1
0236902	Front door window wing weatherstrip--upper right	-	-	-	-	-	-	-	1	1	1
0236908	Front door window wing weatherstrip--upper left	-	-	-	-	-	-	-	1	1	1
0236900	Front door window wing weatherstrip--lower right	-	-	-	-	-	-	-	1	1	1
0236901	Front door window wing weatherstrip--lower left	-	-	-	-	-	-	-	1	1	1
199167	Rear door anti-rattler	2	2	2	2	2	-	-	-	-	-
218305	Rear door anti-rattler shim	x	x	x	x	x	-	-	-	-	-
185602	Rear door bumper (1-9/32)	x	x	x	x	x	-	-	-	x	-
185601	Rear door bumper (1-11/32)	x	x	x	x	x	-	-	-	x	-
185600	Rear door bumper (1-13/32)	x	x	x	x	x	-	-	-	x	-
218685	Rear door bumper (1-15/32)	x	x	x	x	x	-	-	-	x	-
227886	Rear door bumper--intermediate	-	-	-	-	-	-	-	-	2	-
227888	Rear door bumper--lower	-	-	-	-	-	-	-	-	2	-
227839	Rear door bumper--lower--striker	-	-	-	-	-	-	-	-	2	-
164700	Rear door check strap	2	2	2	2	2	-	-	-	-	-
227894	Rear door check strap	-	-	-	-	-	-	-	-	2	-
164359	Rear door check strap fastener plate	2	2	2	2	2	-	-	-	-	-
227893	Rear door check strap fastener plate	-	-	-	-	-	-	-	-	2	-
6837	Screw No. 10-24 x 7/8 rnd. hd.	-	-	-	-	-	-	-	-	4	-
227897	Rear door check strap guide	-	-	-	-	-	-	-	-	2	-
5829	Screw No. 10-32 x 7/8 flat hd.	-	-	-	-	-	-	-	-	4	-
199965	Rear door check strap guide assembly	2	2	2	2	2	-	-	-	-	-
227576	Rear door diagonal brace	-	-	-	-	-	-	-	-	2	-
236012	Washer countersunk	-	-	-	-	-	-	-	-	4	-
235042	Rear door dovetail--female	2	2	2	2	2	-	-	-	2	-
235046	Rear door dovetail--male	2	2	2	2	2	-	-	-	2	-
224107	Rear door hinge lower--right	1	1	-	-	-	-	-	-	-	-
224106	Rear door hinge lower--left	1	1	-	-	-	-	-	-	-	-
224101	Rear door hinge lower--right	-	-	1	1	1	-	-	-	-	-
236078	Rear door hinge lower--right	-	-	-	-	-	-	-	-	1	-
224100	Rear door hinge lower--left	-	-	1	1	1	-	-	-	-	-
236079	Rear door hinge lower--left	-	-	-	-	-	-	-	-	1	-
224103	Rear door hinge upper--right	-	1	1	1	-	-	-	-	-	-
224102	Rear door hinge upper--left	-	1	1	1	-	-	-	-	-	-

Piece No.	Name	(17th Series)									
		1232 5 P. Formal Sedan	1233 5 P. Tour. Sedan	1234 7 P. Tour. Sedan	1235 7 P. Tour. Sedan Lim.	1236 5 P. Club Sedan	1237 5 P. Coupe	1238 2-4 P. Coupe	1239 2-4 P. Conv. Coupe	1253 5 P. Conv. Sedan	1227 5 P. Victoria
		No. Required									
229224	Rear door hinge upper--right	1	-	-	-	1	-	-	-	-	-
229223	Rear door hinge upper--left	1	-	-	-	1	-	-	-	-	
236080	Rear door hinge upper--right	-	-	-	-	-	-	-	-	-	
236081	Rear door hinge upper--left	-	-	-	-	-	-	-	-	1	
228203	Rear door hinge screw 5/16-24 x 5/8 flat hd.	-	-	-	-	-	-	-	-	16	
5854	Rear door hinge screw 1/4-28 x 1-1/4 flat hd.	2	2	2	2	2	-	-	-	-	
5747	Screw 1/4-28 x 1-5/8 flat hd.	2	2	2	2	2	-	-	-	-	
5820	Screw 1/4-28 x 1-31/32 oval hd.	4	4	4	4	4	-	-	-	-	
227915	Screw 5/16-24 x 17/32 flat hd. special	-	-	-	-	-	-	-	-	16	
5899	Lockwasher 5/16 countersunk (Shakeproof)	-	-	-	-	-	-	-	-	32	
227515	Rear door hinge pillar finishing plate--lt.	-	-	-	-	-	-	-	-	1	
227514	Rear door hinge pillar finishing plate--rt.	-	-	-	-	-	-	-	-	1	
6905	Screw No. 4-40 x 3/8 Phillips O.H. self-tapping	-	-	-	-	-	-	-	-	10	
224090	Rear door hinge pin	4	4	4	4	4	-	-	-	-	
230588	Rear door hinge pin	-	-	-	-	-	-	-	-	4	
218600	Rear door hinge pin screw	4	4	4	4	4	-	-	-	-	
231821	Rear door hinge pin screw	-	-	-	-	-	-	-	-	4	
5500	Lockwasher No. 10	4	4	4	4	4	-	-	-	4	
235628	Rear door lock--right	1	1	1	1	1	-	-	-	-	
235629	Rear door lock--left	1	1	1	1	1	-	-	-	-	
183170	Rear door lock--right	-	-	-	-	-	-	-	-	1	
183171	Rear door lock--left	-	-	-	-	-	-	-	-	1	
8022	Screw No. 10-32 x 3/8 oval hd.	-	-	-	-	-	-	-	-	4	
5829	Screw No. 10-32 x 7/8 flat hd.	4	4	4	4	4	-	-	-	4	
5491	Lockwasher 3/16 countersunk (Shakeproof)	4	4	4	4	4	-	-	-	4	
245220	Rear door lock handle (With key lock) (With partition for 33)	1	1	-	1	-	-	-	-	-	
245190	Rear door lock handle	1	2	2	1	2	-	-	-	-	
245191	Rear door lock handle (1 required with partition)	-	-	-	-	-	-	-	-	2	
245221	Rear door lock handle--right (Use with partition only)	-	-	-	-	-	-	-	-	1	
337017	Rear door lock handle cylinder lock	1	-	-	1	-	-	-	-	-	
6775	Rear door lock handle screw No. 12-24 x 7/16 (Phillips) rnd. hd.	2	2	2	2	2	-	-	-	2	
6719	Lockwasher No. 12 (Shakeproof)	2	2	2	2	2	-	-	-	2	
337638	Rear door lock handle gasket	2	2	2	2	2	-	-	-	2	
337566	Rear door lock locking rod knob	2	2	2	2	2	-	-	-	-	
235620	Rear door lock remote control--right	-	-	1	1	1	-	-	-	-	
235621	Rear door lock remote control--left	-	-	1	1	1	-	-	-	-	
235630	Rear door lock remote control--right	1	1	-	-	-	-	-	-	-	
235631	Rear door lock remote control--left	1	1	-	-	-	-	-	-	-	
236038	Rear door lock remote control--right	-	-	-	-	-	-	-	-	1	
236039	Rear door lock remote control--left	-	-	-	-	-	-	-	-	1	
245197	Rear door lock remote control handle	2	2	2	2	2	-	-	-	2	
245186	Rear door lock remote control handle escutcheon plate	2	2	2	2	2	-	-	-	2	
133264	Rear door lock remote control handle escutcheon plate spring	2	2	2	2	2	-	-	-	2	
133339	Rear door lock remote control handle insert	2	2	2	2	2	-	-	-	2	
132972	Rear door lock remote control handle pin ..	2	2	2	2	2	-	-	-	2	

Piece No.	Name	(17th Series)									
		1232 5 P. Formal Sedan	1233 5 P. Tour. Sedan	1234 7 P. Tour. Sedan	1235 7 P. Tour. Sedan Lim.	1236 5 P. Club Sedan	1237 5 P. Coupe	1238 2-4 P. Coupe	1239 2-4 P. Conv. Coupe	1253 5 P. Conv. Sedan	1257 5 P. Victoria
		No. Required									
229996	Rear door lock striker	2	2	2	2	2	-	-	-	2	-
6835	Screw No. 12-24 x 7/8 flat hd.	-	-	-	-	-	-	-	-	4	-
241150	Rear door panel assembly--right	1	-	-	-	-	-	-	-	-	-
241151	Rear door panel assembly--left	1	-	-	-	-	-	-	-	-	-
241152	Rear door panel assembly--right	-	1	-	-	-	-	-	-	-	-
241153	Rear door panel assembly--left	-	1	-	-	-	-	-	-	-	-
241154	Rear door panel assembly--right	-	-	1	1	-	-	-	-	-	-
241155	Rear door panel assembly--left	-	-	1	1	-	-	-	-	-	-
241156	Rear door panel assembly--right	-	-	-	-	1	-	-	-	-	-
241157	Rear door panel assembly--left	-	-	-	-	1	-	-	-	-	-
241304	Rear door panel assembly--right	-	-	-	-	-	-	-	-	1	-
241305	Rear door panel assembly--left	-	-	-	-	-	-	-	-	1	-
235022	Rear door truss assembly	4	4	4	4	4	-	-	-	-	-
231982	Rear door truss turnbuckle	4	4	4	4	4	-	-	-	-	-
241285	Rear door weatherstrip--86" long	2	2	2	2	2	-	-	-	-	-
241283	Rear door weatherstrip--19" long	2	2	-	-	-	-	-	-	-	-
241286	Rear door weatherstrip--22" long	-	-	2	2	2	-	-	-	-	-
241287	Rear door weatherstrip--26" long	-	-	2	2	2	-	-	-	-	-
241288	Rear door weatherstrip--34" long	2	2	-	-	-	-	-	-	-	-
314936	Clip	x	x	x	x	x	-	-	-	-	-
228239	Rear door window to center removable pillar weatherstrip (Black)	-	-	-	-	-	-	-	-	x	-
228238	Rear door window to center removable pillar weatherstrip (Tan)	-	-	-	-	-	-	-	-	x	-
227842	Rear door window to center removable pillar weatherstrip retainer--right	-	-	-	-	-	-	-	-	1	-
227843	Rear door window to center removable pillar weatherstrip retainer--left	-	-	-	-	-	-	-	-	1	-
245072	Rear door window finishing moulding--right.	-	-	1	1	1	-	-	-	-	-
245073	Rear door window finishing moulding--left .	-	-	1	1	1	-	-	-	-	-
245056	Rear door window finishing moulding--right.	1	1	-	-	-	-	-	-	-	-
245057	Rear door window finishing moulding--left .	1	1	-	-	-	-	-	-	-	-
245100	Rear door window finishing moulding--right.	-	-	-	-	-	-	-	-	1	-
245101	Rear door window finishing moulding--left .	-	-	-	-	-	-	-	-	1	-
235771	Rear door window finishing moulding wood- screw ferrule No. 6	x	x	x	x	x	-	-	-	x	-
228239	Rear door window to folding pillar weatherstrip (Black)	-	-	-	-	-	-	-	-	x	-
228238	Rear door window to folding pillar weatherstrip (Tan)	-	-	-	-	-	-	-	-	x	-
227850	Rear door window to folding pillar weatherstrip retainer--right	-	-	-	-	-	-	-	-	1	-
227851	Rear door window to folding pillar weatherstrip retainer--left	-	-	-	-	-	-	-	-	1	-
224854	Rear door window glass	2	2	-	-	-	-	-	-	-	-
220530	Rear door window glass	-	-	2	2	2	-	-	-	-	-
227795	Rear door window glass	-	-	-	-	-	-	-	-	2	-
227796	Rear door window glass and frame assy.--rt.	-	-	-	-	-	-	-	-	1	-
227797	Rear door window glass and frame assy.--lt.	-	-	-	-	-	-	-	-	1	-
230556	Rear door window glass and frame assembly belt anti-rattler--inside	-	-	-	-	-	-	-	-	2	-
230554	Rear door window glass and frame assembly belt anti-rattler--outside	-	-	-	-	-	-	-	-	2	-
308133	Screw No. 6 x 1/2 flat hd. (Parker Kalon)	-	-	-	-	-	-	-	-	2	-

(17th Series)

Piece No.	Name											No. Required		
		1232 5 P. Formal Sedan	1233 5 P. Tour. Sedan	1234 7 P. Tour. Sedan	1235 7 P. Tour. Sedan Lim.	1236 5 P. Club Sedan	1237 5 P. Coupe	1238 2-4 P. Coupe	1239 2-4 P. Conv. Coupe	1243 5 P. Conv. Sedan	1227 5 P. Victoria			
0243926	Rear door window glass frame--right	-	-	-	-	-	-	-	-	-	-	-	1	-
0243927	Rear door window glass frame--left	-	-	-	-	-	-	-	-	-	-	-	1	-
227704	Rear door window glass frame guide--rear rt.	-	-	-	-	-	-	-	-	-	-	-	1	-
227705	Rear door window glass frame guide--rear lt.	-	-	-	-	-	-	-	-	-	-	-	1	-
230536	Rear door window glass frame guide--front right	-	-	-	-	-	-	-	-	-	-	-	1	-
230537	Rear door window glass frame guide--front left	-	-	-	-	-	-	-	-	-	-	-	1	-
8224	Screw No. 10-32 x 5/8 flat hd.	-	-	-	-	-	-	-	-	-	-	-	8	-
228239	Rear door window to header weatherstrip (Black)	-	-	-	-	-	-	-	-	-	-	-	x	-
228238	Rear door window to header weatherstrip (Tan)	-	-	-	-	-	-	-	-	-	-	-	x	-
227846	Rear door window to header weatherstrip retainer--right	-	-	-	-	-	-	-	-	-	-	-	1	-
227847	Rear door window to header weatherstrip retainer--left	-	-	-	-	-	-	-	-	-	-	-	1	-
220528	Rear door window lifter assembly--right ...	-	-	1	1	1	-	-	-	-	-	-	-	-
220529	Rear door window lifter assembly--left	-	-	1	1	1	-	-	-	-	-	-	-	-
224878	Rear door window lifter assembly--right ...	1	1	-	-	-	-	-	-	-	-	-	-	-
224877	Rear door window lifter assembly--left	1	1	-	-	-	-	-	-	-	-	-	-	-
0243928	Rear door window lifter assembly--right ...	-	-	-	-	-	-	-	-	-	-	-	1	-
0243929	Rear door window lifter assembly--left	-	-	-	-	-	-	-	-	-	-	-	1	-
224857	Rear door window lifter bumper	2	2	-	-	-	-	-	-	-	-	-	-	-
220621	Rear door window lifter bumper	-	-	2	2	2	-	-	-	-	-	-	-	-
235168	Rear door window regulator--right	1	1	1	1	1	-	-	-	-	-	-	-	-
227798	Rear door window regulator--right	-	-	-	-	-	-	-	-	-	-	-	1	-
235169	Rear door window regulator--left	1	1	1	1	1	-	-	-	-	-	-	-	-
227799	Rear door window regulator--left	-	-	-	-	-	-	-	-	-	-	-	1	-
8214	Screw 1/4-28 x 3/4 flat hd.	4	4	4	4	4	-	-	-	-	-	-	-	-
6551	Screw 1/4-20 x 3/4 flat hd.	-	-	-	-	-	-	-	-	-	-	-	12	-
236012	Washer	-	-	-	-	-	-	-	-	-	-	-	12	-
8202	Screw	2	2	2	2	2	-	-	-	-	-	-	-	-
245194	Rear door window regulator handle	2	2	2	2	2	-	-	-	-	-	-	2	-
335191	Rear door window regulator handle washer ..	2	2	2	2	2	-	-	-	-	-	-	2	-
245186	Rear door window regulator handle escutcheon plate	2	2	2	2	2	-	-	-	-	-	-	2	-
133264	Rear door window regulator handle escutcheon plate spring	2	2	2	2	2	-	-	-	-	-	-	2	-
133339	Rear door window regulator handle insert ..	2	2	2	2	2	-	-	-	-	-	-	2	-
132972	Rear door window regulator handle pin	2	2	2	2	2	-	-	-	-	-	-	2	-
220697	Rear door window runway lower	4	4	-	-	-	-	-	-	-	-	-	-	-
220696	Rear door window runway lower	-	-	4	4	4	-	-	-	-	-	-	-	-
224858	Rear door window runway upper	2	2	-	-	-	-	-	-	-	-	-	-	-
220706	Rear door window runway upper	-	-	2	2	2	-	-	-	-	-	-	-	-
163168	Rear door window runway retainer	2	2	2	2	2	-	-	-	-	-	-	-	-
136008	Rear door window runway shim 1/32 x 1/2 x 40"	x	x	x	x	x	-	-	-	-	-	-	-	-
132429	Rear door window runway shim 1/16 x 1/2 x 40"	x	x	x	x	x	-	-	-	-	-	-	-	-
0243930	Rear door window sash carriage--rear	-	-	-	-	-	-	-	-	-	-	-	2	-
195717	Rear door window stop bumper	-	-	-	-	-	-	-	-	-	-	-	2	-

Piece No.	Name	(17th Series)									
		1232 5 P. Formal Sedan	1233 5 P. Tour. Sedan	1234 7 P. Tour. Sedan	1235 7 P. Tour. Sedan Lim.	1236 5 P. Club Sedan	1237 5 P. Coupe	1238 2-4 P. Coupe	1239 2-4 P. Conv. Coupe	1253 5 P. Conv. Sedan	1227 5 P. Victoria
		No. Required									
ELECTRICAL											
33287	Electrical-body feed cable terminal 13/64 eye	x	x	x	x	x	x	-	-	x	x
71397	Electrical-body feed cable terminal 11/64 eye (open end)	x	x	x	x	x	x	x	x	x	x
225377	Electrical-body feed cable terminal 11/64 eye	x	-	-	-	-	-	-	-	-	-
36111	Electrical-body feed cable terminal insulator	x	x	x	x	x	x	x	x	x	x
48202	Electrical-body ground cable terminal 1/4 eye	x	x	x	x	x	x	x	-	-	-
33287	Electrical-body ground cable terminal 13/64 eye	-	-	-	-	-	-	-	-	-	x
171863	Electrical-body ground cable terminal (cigar lighter)	-	-	-	-	-	-	-	-	-	x
225377	Electrical-body ground cable terminal 11/64 eye	x	-	-	-	-	-	-	-	-	-
5873	Screw 1/4-28 x 9/16 hex. hd.	2	2	2	2	2	2	-	-	-	-
5502	Lockwasher 1/4	2	2	2	2	2	2	-	-	-	-
7004	Nut 1/4-28	2	2	2	2	2	2	-	-	-	-
167069	Electrical-body wiring cable (19 strand No. 16 Ga. Green Braid)	x	x	x	x	x	x	x	x	x	x
179251	Electrical-body wiring cable (19 strand No. 12 Ga. Green Braid)	x	x	x	x	x	x	-	-	x	-
166403	Electrical-body wiring cable (19 strand No. 12 Ga. Red Braid)	x	x	x	x	x	x	-	-	x	-
166406	Electrical-body wiring cable (19 strand No. 16 Ga. Red Braid)	x	x	x	x	x	x	x	x	x	x
166404	Electrical-body wiring cable (19 strand No. 16 Ga. Black Braid)	x	x	x	x	x	x	x	x	x	x
166405	Electrical-body wiring cable (19 strand No. 16 Ga. Black with Red Tracer Braid)	x	x	x	x	x	x	x	-	-	-
194286	Electrical-body wiring cable clip	2	2	2	2	2	2	2	2	-	-
240635	Electrical-body wiring cable connector tip male	x	x	x	x	x	x	x	-	-	-
224442	Electrical-body wiring cable groove clip	x	x	x	x	x	-	-	-	-	-
227878	Electrical-body wiring cable loom--45" long (Body feed cable)	-	-	-	-	-	-	-	-	x	x
236794	Electrical-body wiring cable loom--27" long (Cigar lighter cable)	-	-	-	-	-	-	-	-	x	-
236793	Electrical-body wiring cable loom--4" long (Door switch and tonneau light cable)	-	-	-	-	-	-	-	-	x	-
29254	Electrical-body wiring cable staple insulated No. 1 x 1/2	x	x	x	x	x	x	x	x	x	x
33287	Electrical-body wiring dome light cable terminal 13/64 eye	5	2	2	5	2	2	2	-	-	-
36111	Electrical-body wiring dome light cable terminal insulator	5	2	2	5	2	2	2	-	-	-
133004	Electrical-dictograph winder	-	-	-	1	-	-	-	-	-	-
5696	Screw No. 8-32 x 3/8 rnd. hd.	-	-	-	2	-	-	-	-	-	-
5695	Lockwasher No. 8	-	-	-	2	-	-	-	-	-	-
7002	Nut No. 8-32	-	-	-	2	-	-	-	-	-	-
224265	Electrical-dictograph winder bracket	-	-	-	1	-	-	-	-	-	-
5853	Screw 1/4-28 x 1/2 rnd. hd.	-	-	-	2	-	-	-	-	-	-

Piece No.	Name (17th Series)	No. Required									
		1232 5 P. Formal Sedan	1233 5 P. Tour. Sedan	1234 7 P. Tour. Sedan	1235 7 P. Tour. Sedan Lim.	1236 5 P. Club Sedan	1237 5 P. Coupe	1238 2-4 P. Coupe	1239 2-4 P. Conv. Coupe	1253 5 P. Conv. Sedan	1227 5 P. Victoria
5502	Lockwasher 1/4	-	-	-	2	-	-	-	-	-	-
7004	Nut 1/4-28	-	-	-	2	-	-	-	-	-	-
229866	Electrical-dictograph receiver	-	-	-	1	-	-	-	-	-	-
235423	Electrical-dictograph receiver support bracket--front	-	-	-	1	-	-	-	-	-	-
5315	Screw 1/4-28 x 1-3/8 hex. hd.	-	-	-	1	-	-	-	-	-	-
62065	Washer 1/4 special	-	-	-	1	-	-	-	-	-	-
7004	Nut 1/4-28	-	-	-	1	-	-	-	-	-	-
229865	Electrical-dictograph receiver support bracket--rear	-	-	-	1	-	-	-	-	-	-
5580	Screw No. 10-32 x 1 flat hd.	-	-	-	2	-	-	-	-	-	-
5870	Screw No. 10-32 x 1/2 rnd. hd.	-	-	-	2	-	-	-	-	-	-
5500	Lockwasher No. 10	-	-	-	4	-	-	-	-	-	-
3866	Washer 3/16	-	-	-	2	-	-	-	-	-	-
7003	Nut No. 10-32	-	-	-	4	-	-	-	-	-	-
211003	Electrical-dictograph transmitter and winder assembly	-	-	-	1	-	-	-	-	-	-
337113	Electrical-dome light	-	1	1	-	1	1	1	-	-	-
337113	Electrical-dome light front (With partition for 1233)	1	1	-	1	-	-	-	-	-	-
337114	Electrical-dome light rear (With partition for 1233)	1	1	-	1	-	-	-	-	-	-
102585	Electrical-dome light bulb (Mazda No. 81) 6 C.P.--(6 volt)	3	2	1	3	1	1	1	-	-	-
220761	Electrical-dome light door switch	2	2	2	2	2	2	2	-	-	-
337115	Electrical-dome light glass and rim	2	2	1	2	1	1	1	-	-	-
242225	Electrical-dome light (front) instrument board switch (2 point) (With partition for 1233)	1	1	-	1	-	-	-	-	-	-
240391	Electrical-dome light (rear) instrument board switch (3 point) (With partition for 1233)	1	1	-	-	-	-	-	-	-	-
235175	Electrical-dome light reflector (2 sockets) (With partition for 1233)	1	1	-	1	-	-	-	-	-	-
235161	Electrical-dome light reflector (1 socket)	1	1	1	1	1	1	1	-	-	-
337069	Electrical-dome light switch (3 point)	1	1	1	2	1	1	1	-	-	-
337112	Electrical-dome light switch plate	1	1	1	2	1	1	1	-	-	-
107654	Electrical-rear compartment light discon- nector plug socket	-	-	-	-	-	-	-	-	-	1
5984	Screw No. 6 x 3/8 rnd. hd. (Parker Kalon)	-	-	-	-	-	-	-	-	-	2
136593	Electrical-rear compartment light switch (2 point)	-	-	-	-	-	-	-	-	-	1
218105	Screw No. 4 x 5/8 oval hd. (Parker Kalon)	-	-	-	-	-	-	-	-	-	2
33287	Electrical-rear compartment light to switch cable assembly terminal 13/64 eye	-	-	-	-	-	-	-	-	-	1
245204	Electrical-rear quarter light	2	2	2	2	2	2	2	-	-	-
5868	Screw No. 10-32 x 5/8 flat hd.	2	2	2	2	2	2	2	-	-	-
102590	Electrical-rear quarter light bulb 6 volt 3 C.P. G-6 single contact	2	2	2	2	2	2	2	-	-	-
245205	Electrical-rear quarter light glass and rim	2	2	2	2	2	2	2	-	-	-
183836	Electrical-rear quarter light reflector ...	2	2	2	2	2	2	2	-	-	-
337068	Electrical-rear quarter light switch (2 point)	1	1	1	1	1	1	1	-	-	-

Piece No.	Name	(17th Series)									
		1232 S P. Formal Sedan	1233 5 P. Tour. Sedan	1234 7 P. Tour. Sedan	1235 7 P. Tour. Sedan Lim.	1236 S P. Club Sedan	1237 5 P. Coupe	1238 2.4 P. Coupe	1239 2.4 P. Conv. Coupe	1253 5 P. Conv. Sedan	1227 5 P. Victoria
		No. Required									
337111	Electrical-rear quarter light switch plate.	1	1	1	1	1	1	-	-	-	-
102590	Electrical-rumble seat compartment light bulb 6 volt single contact 3 C.P.	-	-	-	-	-	-	1	1	-	-
107654	Electrical-rumble seat compartment light disconnecter plug socket	-	-	-	-	-	-	1	1	-	-
136593	Electrical-rumble seat compartment light switch (2 point)	-	-	-	-	-	-	1	1	-	-
220761	Electrical-running board light door switch.	-	-	-	-	-	-	-	2	-	2
6567	Electrical-running board light door switch operative screw No. 10 x 5/8 binding hd. (Parker Kalon) Type Z (Used on 1139-27)..	-	-	-	-	-	-	-	x	-	x
240635	Electrical-running board light to switch cable assembly connector tip--male	-	-	-	-	-	-	-	2	-	2
171863	Electrical smoking case cigar lighter to ground cable clip	2	2	2	2	2	-	-	-	-	-
33287	Electrical smoking case cigar lighter to ground cable terminal	-	-	-	-	-	-	-	-	1	-
245204	Electrical tonneau light	-	-	-	-	-	-	-	-	1	-
5868	Screw No. 10-32 x 5/8 flat hd.	-	-	-	-	-	-	-	-	1	-
245205	Electrical tonneau light glass and rim	-	-	-	-	-	-	-	-	1	-
102590	Electrical tonneau light bulb	-	-	-	-	-	-	-	-	1	-
240635	Electrical tonneau light to door switch cable connector tip--male	-	-	-	-	-	-	-	-	2	-
220761	Electrical tonneau light door switch	-	-	-	-	-	-	-	-	2	-
197493	Screw No. 6-32 x 1/4 oval hd.	-	-	-	-	-	-	-	-	4	-
229433	Electrical tonneau light door switch operating screw No. 10 x 1/4 binding hd. (Parker Kalon) Type Z	-	-	-	-	-	-	-	-	x	-
33287	Electrical tonneau light to ground cable terminal 13/64	-	-	-	-	-	-	-	-	1	-
5676	Screw No. 10-32 x 3/8 rnd. hd.	-	-	-	-	-	-	-	-	1	-
183836	Electrical tonneau light reflector	-	-	-	-	-	-	-	-	1	-
102590	Electrical-vanity cabinet light bulb 7 volt single contact	2	-	-	-	-	-	-	-	-	-
107654	Electrical-vanity cabinet light disconnecter plug socket	2	-	-	-	-	-	-	-	-	-

FLOOR

231711	Floor-battery cover assembly	1	1	1	1	1	1	1	1	1	1
231713	Floor-battery cover fastener	1	1	1	1	1	1	1	1	1	1
305880	Floor-battery cover fastener rivet	1	1	1	1	1	1	1	1	1	1
231687	Floor-battery cover fastener striker plate.	1	1	1	1	1	1	1	1	1	1
231715	Floor-battery cover weatherstrip	1	1	1	1	1	1	1	1	1	1
235354	Floor-board (front) assembly	1	1	1	1	1	1	1	1	1	1
231632	Floor-board (rear) assembly	1	1	1	1	-	-	-	-	1	-
185832	Floor-board (front) washer	4	4	4	4	4	4	4	4	4	4
7906	Screw 1/4-28 x 3/4 rnd. hd.	2	2	2	2	2	2	2	2	2	2
5502	Lockwasher 1/4	2	2	2	2	2	2	2	2	2	2
5580	Floor-board to cross sill screw No. 10-32 x 1 flat hd.	-	-	-	-	-	-	2	2	-	-
5500	Lockwasher No. 10	-	-	-	-	-	-	2	2	-	-
7003	Nut No. 10-32	-	-	-	-	-	-	2	2	-	-
220771	Floor-board (front) felt front	1	1	1	1	1	1	1	1	1	1

Piece No.	(17th Series) Name	No. Required									
		1232 5 P. Formal Sedan	1233 5 P. Tour. Sedan	1234 7 P. Tour. Sedan	1235 7 P. Tour. Sedan Lim.	1236 5 P. Club Sedan	1237 5 P. Coupe	1238 2-4 P. Coupe	1239 2-4 P. Conv. Coupe	1253 5 P. Conv. Sedan	1237 5 P. Victoria
220773	Floor-board (front) felt rear	1	1	1	1	1	1	1	1	1	1
220772	Floor-board (front) felt side	2	2	2	2	2	2	2	2	2	2
48317	Rivet	28	28	28	28	28	28	28	28	28	28
235355	Floor-board (front) hole cover assembly ...	1	1	1	1	1	1	1	1	1	1
231631	Floor-board (rear) cut-out plate	1	1	1	1	1	1	1	1	1	1
231742	Floor-door scuff plate front lower--right .	1	1	1	1	-	-	-	1	1	1
231743	Floor-door scuff plate front lower--left ..	1	1	1	1	-	-	-	1	1	1
231746	Floor-door scuff plate front lower--right .	-	-	-	-	1	-	-	-	-	-
231747	Floor-door scuff plate front lower--left ..	-	-	-	-	1	-	-	-	-	-
231738	Floor-door scuff plate front lower--right .	-	-	-	-	-	1	1	-	-	-
231739	Floor-door scuff plate front lower--left ..	-	-	-	-	-	1	1	-	-	-
231528	Floor-door scuff plate front upper--right .	-	-	-	-	1	-	-	-	-	-
231529	Floor-door scuff plate front upper--left ..	-	-	-	-	1	-	-	-	-	-
231744	Floor-door scuff plate front upper--right .	1	1	1	1	-	1	1	-	-	-
231745	Floor-door scuff plate front upper--left ..	1	1	1	1	-	1	1	-	-	-
236026	Floor-door scuff plate front upper--right .	-	-	-	-	-	-	-	1	-	1
236686	Floor-door scuff plate front upper--right .	-	-	-	-	-	-	-	-	1	-
236027	Floor-door scuff plate front upper--left ..	-	-	-	-	-	-	-	1	-	1
236687	Floor-door scuff plate front upper--left ..	-	-	-	-	-	-	-	-	1	-
224287	Floor-door scuff plate rear lower	2	2	-	-	-	-	-	-	-	-
224307	Floor-door scuff plate rear lower--right ..	-	-	1	1	1	-	-	-	1	-
224308	Floor-door scuff plate rear lower--left ...	-	-	1	1	1	-	-	-	1	-
226262	Floor-door scuff plate rear upper--right ..	1	1	-	-	-	-	-	-	-	-
226261	Floor-door scuff plate rear upper--left ...	1	1	-	-	-	-	-	-	-	-
224407	Floor-door scuff plate rear upper--right ..	-	-	1	1	1	-	-	-	-	-
227738	Floor-door scuff plate rear upper--right ..	-	-	-	-	-	-	-	-	1	-
224408	Floor-door scuff plate rear upper--left ...	-	-	1	1	1	-	-	-	-	-
227739	Floor-door scuff plate rear upper--left ...	-	-	-	-	-	-	-	-	1	-
6595	Screw No. 6 x 7/8 oval hd. (Parker Kalon--Type A)	-	-	-	-	-	-	-	42	56	42
231635	Floor-rear seat pan and side sill assembly.	1	1	1	1	-	-	-	-	-	-
241309	Floor-rear seat pan and side sill assembly.	-	-	-	-	-	-	-	-	1	-
231758	Floor-rear seat pan and side sill assembly.	-	-	-	-	1	-	-	-	-	-
235061	Floor-rear seat pan and side sill assembly.	-	-	-	-	-	1	-	-	-	-
241311	Floor-rear seat pan and side sill assembly.	-	-	-	-	-	-	-	-	-	1
231756	Floor-rear seat pan and side sill assembly.	-	-	-	-	-	-	1	1	-	-

FOLDING SEAT

Always send samples of material when ordering trimmed assemblies, as the assemblies are upholstered to match the body interior.

233113	Folding seat trimmed assembly	-	-	2	-	-	-	-	-	-	-
233387	Folding seat trimmed assembly	-	-	-	2	-	-	-	-	-	-
226263	Folding seat trimmed assembly	1	1	-	-	-	-	-	-	-	-
184270	Folding seat untrimmed assembly	1	1	-	-	-	-	-	-	-	-
224065	Folding seat untrimmed assembly	-	-	2	2	-	-	-	-	-	-
224154	Folding seat back untrimmed assembly	-	-	2	2	-	-	-	-	-	-
184853	Folding seat back untrimmed assembly	1	1	-	-	-	-	-	-	-	-
184260	Folding seat back bracket--right	1	1	-	-	-	-	-	-	-	-
184259	Folding seat back bracket--left	1	1	-	-	-	-	-	-	-	-
184866	Screw 1/4-28 x 1-1/8 flat hd.	2	2	-	-	-	-	-	-	-	-
7004	Nut 1/4-28	2	2	-	-	-	-	-	-	-	-

Piece No.	Name	(17th Series)									
		1232 5 P. Formal Sedan	1233 5 P. Tour. Sedan	1234 7 P. Tour. Sedan	1235 7 P. Tour. Sedan Lim.	1236 5 P. Club Sedan	1237 5 P. Coupe	1238 2-4 P. Coupe	1239 2-4 P. Conv. Coupe	1253 5 P. Conv. Sedan	1257 5 P. Victoria
		No. Required									
185113	Folding seat back to seat frame screw	-	-	4	4	-	-	-	-	-	-
184268	Folding seat back to seat frame screw	2	2	-	-	-	-	-	-	-	-
243690	Folding seat cushion pad	1	1	-	-	-	-	-	-	-	-
233798	Folding seat cushion pad	-	-	2	-	-	-	-	-	-	-
172294	Folding seat cushion spring	-	-	-	2	-	-	-	-	-	-
231991	Folding seat floor plate assembly	-	-	1	1	-	-	-	-	-	-
224064	Folding seat frame assembly	-	-	2	2	-	-	-	-	-	-
5580	Screw No. 10-32 x 1 flat hd.	-	-	16	16	-	-	-	-	-	-
5229	Screw 1/4-28 x 1-3/8 flat hd.	-	-	8	8	-	-	-	-	-	-
8220	Screw 1/4-28 x 1-1/2 flat hd.	-	-	8	8	-	-	-	-	-	-
7003	Nut No. 10-32	-	-	16	16	-	-	-	-	-	-
7004	Nut 1/4-28	-	-	16	16	-	-	-	-	-	-
3867	Washer 3/16 special	-	-	4	4	-	-	-	-	-	-
185118	Folding seat frame side—right	-	-	2	2	-	-	-	-	-	-
185111	Folding seat frame side—left	-	-	2	2	-	-	-	-	-	-
245200	Folding seat handle	1	1	2	2	-	-	-	-	-	-
100100	Folding seat pivot pin	-	-	4	4	-	-	-	-	-	-
184851	Folding seat support right assembly	1	1	-	-	-	-	-	-	-	-
184852	Folding seat support left assembly	1	1	-	-	-	-	-	-	-	-
206920	Folding seat support—right	-	-	2	2	-	-	-	-	-	-
206919	Folding seat support—left	-	-	2	2	-	-	-	-	-	-
185114	Folding seat support to seat frame screw ..	-	-	4	4	-	-	-	-	-	-
7006	Nut 3/8-24	-	-	4	4	-	-	-	-	-	-
5506	Lockwasher 3/8	-	-	4	4	-	-	-	-	-	-

FOOT REST

245175	Foot rest assembly (Specify set number) ...	-	1	1	1	-	-	-	-	-	-
79574	Foot rest assembly	-	-	-	-	-	-	1	1	-	-
206134	Foot rest bar cushion	-	1	1	1	-	-	-	-	-	-
224555	Foot rest bar end bracket—right	-	1	1	1	-	-	-	-	-	-
224556	Foot rest bar end bracket—left	-	1	1	1	-	-	-	-	-	-
224534	Foot rest bar end to support screw	-	2	2	2	-	-	-	-	-	-
195201	Foot rest bar end to support screw washer .	-	2	2	2	-	-	-	-	-	-
6048	Lockwasher 3/8 (Shakeproof)	-	2	2	2	-	-	-	-	-	-
122146	Foot rest pivot stud	-	-	-	-	-	-	2	2	-	-
180134	Foot rest pivot stud nut—blind	-	-	-	-	-	-	2	2	-	-
224558	Foot rest support	-	2	2	2	-	-	-	-	-	-
224574	Foot rest support bracket	-	2	2	2	-	-	-	-	-	-
147114	Foot rest support bracket	-	-	-	-	-	-	2	2	-	-
5988	Screw No. 10-32 x 1-1/8 O.H.	-	4	4	4	-	-	-	-	-	-
206130	Foot rest support bracket cushion	-	2	2	2	-	-	-	-	-	-
206132	Foot rest support cushion	-	2	2	2	-	-	-	-	-	-

FRONT END

224150	Front end-body to frame bolt bracket—liner 2 x 13-1/2	2	2	2	2	2	2	2	2	2	2
235680	Front end-panel assembly	-	1	1	1	1	1	1	-	-	-
235681	Front end-panel assembly	-	-	-	-	-	-	-	1	1	1
235679	Front end-panel assembly	1	-	-	-	-	-	-	-	-	-
231660	Front end-toe board bracket and support plate assembly—right	1	1	1	1	1	1	1	1	1	1

Piece No.	Name	(17th Series)									
		1232 S P. Formal Sedan	1233 5 P. Tour. Sedan	1234 7 P. Tour. Sedan	1235 7 P. Tour. Sedan Limz.	1236 5 P. Club Sedan	1237 5 P. Coupe	1238 2 4 P. Coupe	1239 2 4 P. Conv. Coupe	1253 5 P. Conv. Sedan	1227 5 P. Victoria
		No. Required									
231661	Front end-toe board bracket and support plate assembly--left	1	1	1	1	1	1	1	1	1	1
6523	Bolt 1/4-28 x 3-5/8 carriage	4	4	4	4	4	4	4	4	4	4
6125	Bolt 5/16-24 x 2 step head	6	6	6	6	6	6	6	6	6	6
5449	Screw 5/16-24 x 3/4 hex. hd.	12	12	12	12	12	12	12	12	12	12
228237	Front end-toe board bracket and support plate assembly screw 5/16-24 x 2 flat hd.	4	4	4	4	4	4	4	4	4	4
3909	Washer 5/16	2	2	2	2	2	2	2	2	2	2
7005	Nut 5/16-24	20	20	20	20	20	20	20	20	20	20
7004	Nut 1/4-28	4	4	4	4	4	4	4	4	4	4
5502	Lockwasher 1/4	4	4	4	4	4	4	4	4	4	4
5504	Lockwasher 5/16	20	20	20	20	20	20	20	20	20	20
236980	Front end-windshield header finishing moulding	-	-	-	-	-	-	-	1	1	1
6762	Screw No. 4 x 3/8 flat hd. (Phillips Sheet Metal)	-	-	-	-	-	-	-	23	23	23

FRONT SEAT

6229	Front seat assembly to track screw 5/16-18 x 1/2 hex. hd.	-	4	4	-	4	4	-	-	-	4
5504	Lockwasher 5/16	-	4	4	-	4	4	-	-	-	4
243364	Front seat back compartment lid trimmed assy.	-	-	-	-	-	-	-	-	1	-
226491	Front seat back compartment lid trimmed assy.	-	-	-	-	-	-	1	-	-	-
227900	Front seat back compartment lid hinge	-	-	-	-	-	-	-	-	3	-
227899	Front seat back compartment lid lock and striker	-	-	-	-	-	-	-	-	1	-
245230	Front seat back frame hinge--center right	-	-	-	-	-	1	-	-	-	1
245231	Front seat back frame hinge--center left	-	-	-	-	-	1	-	-	-	1
337146	Front seat back frame hinge--side right	-	-	-	-	-	1	-	-	-	1
337147	Front seat back frame hinge--side left	-	-	-	-	-	1	-	-	-	1
337278	Front seat back frame hinge bracket--center	-	-	-	-	-	1	-	-	-	1
337149	Front seat back frame hinge bracket--side left	-	-	-	-	-	1	-	-	-	1
337148	Front seat back frame hinge bracket--side right	-	-	-	-	-	1	-	-	-	1
310404	Front seat back pivot screw--center	-	-	-	-	-	1	-	-	-	1
337650	Front seat back pivot screw--side	-	-	-	-	-	2	-	-	-	2
6048	Lockwasher 3/8 (Shakeproof)	-	-	-	-	-	2	-	-	-	2
337273	Front seat back pivot screw nut	-	-	-	-	-	1	-	-	-	1
337151	Front seat back pivot screw spacer--side	-	-	-	-	-	2	-	-	-	2
6614	Washer--center 7/16	-	-	-	-	-	1	-	-	-	1
241041	Front seat back spring	-	-	-	1	-	-	-	-	-	-
241044	Front seat back spring (With partition for 1233)	1	1	-	-	-	-	-	-	-	-
235740	Front seat back spring	-	1	1	-	1	-	-	-	-	-
241072	Front seat (right) back spring	-	-	-	-	-	1	-	-	-	-
241073	Front seat (left) back spring	-	-	-	-	-	1	-	-	-	-
241081	Front seat (left) back spring	-	-	-	-	-	-	1	-	-	-
241080	Front seat (right) back spring	-	-	-	-	-	-	1	-	-	-
235972	Front seat (right) back spring	-	-	-	-	-	-	-	1	-	-
235973	Front seat (left) back spring	-	-	-	-	-	-	-	1	-	-
236784	Front seat (right) back spring	-	-	-	-	-	-	-	-	1	-
241272	Front seat (right) back spring	-	-	-	-	-	-	-	-	-	1

Piece No.	Name	(17th Series)									
		1232 5 P. Formal Sedan	1233 5 P. Tour. Sedan	1234 7 P. Tour. Sedan	1235 7 P. Tour. Sedan Lum.	1236 5 P. Club Sedan	1237 5 P. Coupe	1238 2-4 P. Coupe	1239 2-4 P. Conv. Coupe	1253 5 P. Conv. Sedan	1227 5 P. Victoria
		No. Required									
236785	Front seat (left) back spring	1	1	1	1	1	1	1	1	1	1
241273	Front seat (left) back spring	1	1	1	1	1	1	1	1	1	1
307189	Front seat back spring attaching screw No. 10 x 3/4 bind. hd. (Parker Kalon) ...	-	2	2	-	2	2	-	-	-	2
5818	Lockwasher No. 10 (Shakeproof)	-	2	2	-	2	2	-	-	-	2
31338	Ferrule No. 10	-	-	-	-	-	2	-	-	-	2
314759	Screw No. 10 x 1-1/2 Type A (Parker Kalon)	-	-	-	-	-	2	-	-	-	2
224566	Front seat (left) back valance rod	-	-	-	-	-	-	1	1	-	-
236057	Front seat (left) back valance rod	-	-	-	-	-	-	-	-	1	-
245262	Front seat back valance rod	-	1	1	-	1	-	-	-	-	-
212683	Front seat (left) back valance rod bracket.	-	-	-	-	-	-	1	1	1	-
<p>Always send samples of material when ordering cushion assemblies, as the assemblies are upholstered to match the body interior.</p>											
244131	Front seat cushion (trimmed) assembly (Use with partition for 1233)	1	1	-	-	-	-	-	-	-	-
244133	Front seat cushion (trimmed) assembly	-	-	-	1	-	-	-	-	-	1
244136	Front seat cushion (trimmed) assembly	-	1	1	-	1	-	-	-	-	1
244137	Front seat cushion (trimmed) assembly	-	-	-	-	-	1	-	-	-	1
243179	Front seat cushion (trimmed) assembly	-	-	-	-	-	-	-	-	-	1
233049	Front seat (left) cushion (trimmed) assy. .	-	-	-	-	-	-	1	-	-	-
233046	Front seat (left) cushion (trimmed) assy. .	-	-	-	-	-	-	-	1	-	-
243137	Front seat (left) cushion (trimmed) assy. .	-	-	-	-	-	-	-	-	1	-
243136	Front seat (right) cushion (trimmed) assy..	-	-	-	-	-	-	-	-	1	-
233048	Front seat (right) cushion (trimmed) assy..	-	-	-	-	-	-	1	-	-	-
233047	Front seat (right) cushion (trimmed) assy..	-	-	-	-	-	-	-	1	-	-
241040	Front seat cushion spring (With partition for 1233)	1	1	-	1	-	-	-	-	-	-
235741	Front seat cushion spring	-	1	1	-	1	-	-	-	-	-
241078	Front seat (right) cushion spring	-	-	-	-	-	-	1	-	-	-
236786	Front seat (right) cushion spring	-	-	-	-	-	-	-	-	1	-
235970	Front seat (right) cushion spring	-	-	-	-	-	-	-	1	-	-
235971	Front seat (left) cushion spring	-	-	-	-	-	-	-	1	-	-
236787	Front seat (left) cushion spring	-	-	-	-	-	-	-	-	1	-
241079	Front seat (left) cushion spring	-	-	-	-	-	-	1	-	-	-
241074	Front seat cushion spring	-	-	-	-	-	-	1	-	-	-
241274	Front seat cushion spring	-	-	-	-	-	-	-	-	-	1
326058	Front seat operating button	-	-	-	-	-	-	1	-	-	1
325515	Front seat operating button and link assy..	-	-	-	-	-	-	1	-	-	1
318535	Front seat operating button and rod assy. .	-	1	1	-	1	-	-	-	-	-
4280	Pin 1/16 x 1/2 spring cotter	-	1	1	-	1	-	-	-	-	-
224303	Front seat left operating button rod and cable assembly	-	-	-	-	-	-	1	-	-	-
226787	Front seat (left) operating button rod and cable assembly	-	-	-	-	-	-	-	1	-	-
227631	Front seat (left) operating button rod and cable assembly	-	-	-	-	-	-	-	-	1	-
7901	Screw No. 10-32 x 5/8 round hd.	-	-	-	-	-	-	1	1	1	-
220797	Front seat (left) operating button finish- ing plate	-	-	-	-	-	-	1	1	1	-
331638	Front seat operating button finishing plate	-	-	-	-	-	-	1	-	-	1
318533	Front seat operating button finishing plate	-	1	1	-	1	-	-	-	-	-

Piece No.	Name	(17th Series)									
		1232 5 P. Formal Sedan	1233 5 P. Tour. Sedan	1234 7 P. Tour. Sedan	1235 7 P. Tour. Sedan Lim.	1236 5 P. Club Sedan	1237 5 P. Coupe	1238 2-4 P. Coupe	1239 2-4 P. Conv. Coupe	1253 5 P. Conv. Sedan	1227 5 P. Victoria
		No. Required									
308802	Front seat operating button finishing plate screw No. 6 x 3/8 binding hd. (Parker Kalon)	-	-	-	-	-	1	-	-	-	1
6766	Screw No. 6 x 7/8 oval hd. (Parker Kalon) (Phillips Sheet Metal)	-	2	2	-	2	-	-	-	-	-
325516	Front seat operating button link	-	-	-	-	-	1	-	-	-	1
4280	Cotter pin 1/16 x 1/2	-	-	-	-	-	1	-	-	-	1
310642	Front seat operating button pin	-	-	-	-	-	1	-	-	-	1
318526	Front seat operating button and rod shield	-	1	1	-	1	-	-	-	-	-
226527	Front seat (left) operating button spring	-	-	-	-	-	-	1	1	1	-
224302	Front seat (left) operating cable guide assembly	-	-	-	-	-	-	1	1	1	-
327258	Front seat operating spring	-	1	1	-	1	1	-	-	-	1
122611	Front seat package compartment lid hinge ..	-	-	-	-	-	-	3	-	-	-
220878	Front seat package compartment lid lock knob (cylinder locking type)	-	-	-	-	-	-	1	-	-	-
226361	Washer 3/4 plain special	-	-	-	-	-	-	1	-	-	-
220879	Nut 3/4-28 thread special	-	-	-	-	-	-	1	-	-	-
226722	Front seat package compartment lid lock striker plate	-	-	-	-	-	-	1	-	-	-
212848	Front seat (left) support operating mechanism--right	-	-	-	-	-	-	1	1	1	-
235773	Front seat support operating mechanism--left	-	1	1	-	1	1	-	-	-	1
235808	Front seat (left) support operating mechanism--right	-	1	1	-	1	1	-	-	-	1
212849	Front seat (left) support operating mechanism--left	-	-	-	-	-	-	1	1	1	-
5483	Screw 5/16-24 x 3/4 hex. hd.	-	2	2	-	2	2	-	-	-	2
7864	Screw 5/16-24 x 2-1/4 hex. hd.	-	-	-	-	-	-	1	1	1	-
7816	Screw 5/16-24 x 2-1/2 hex. hd.	-	-	-	-	-	-	1	1	1	-
5909	Screw 5/16-24 x 1-1/2 hex. hd.	-	-	-	-	-	2	-	-	-	2
5906	Screw 5/16-24 x 2-1/8 hex. hd.	-	2	2	-	2	-	-	-	-	-
5907	Screw 5/16-24 x 1-3/4 hex. hd.	-	-	-	-	-	-	1	1	1	-
5566	Screw 5/16-24 x 1-1/8 hex. hd.	-	-	-	-	-	-	1	1	1	-
5324	Screw 5/16-24 x 3-1/2 hex. hd.	-	-	-	-	-	-	-	-	-	1
6091	Screw 5/16-24 x 3 hex. hd.	-	-	-	-	-	-	2	2	1	-
3909	Plain washer 5/16 special	-	-	-	-	-	-	-	-	4	-
7005	Nut 5/16-24 standard	-	-	-	-	-	-	2	2	4	-
5504	Lockwasher 5/16	-	4	4	-	4	4	4	4	4	4
235340	Front seat support operating mechanism connecting shaft	-	1	1	-	1	-	-	-	-	-
235341	Front seat support operating mechanism connecting shaft	-	-	-	-	-	1	-	-	-	1
0320707	Front seat support operating mechanism side lock	-	1	1	-	1	1	-	-	-	-
GOLF COMPARTMENT											
224713	Golf compartment door hinge assembly	-	-	-	-	-	-	4	4	-	-
224704	Golf compartment door hinge seal	-	-	-	-	-	-	4	4	-	-
308425	Golf compartment door lock	-	-	-	-	-	-	2	2	-	-
308482	Golf compartment door lock cylinder lock ..	-	-	-	-	-	-	2	2	-	-
143615	Golf compartment door lock striker	-	-	-	-	-	-	2	2	-	-

(17th Series)

Piece No.	Name	No. Required									
		1232 5 P. Formal Sedan	1233 5 P. Tour. Sedan	1234 7 P. Tour. Sedan	1235 7 P. Tour. Sedan Lim.	1236 5 P. Club Sedan	1237 5 P. Coupe	1238 2-4 P. Coupe	1239 2-4 P. Conv. Coupe	1253 5 P. Conv. Sedan	1227 5 P. Victoria
224728	Golf compartment door panel--right	-	-	-	-	-	-	1	-	-	-
224729	Golf compartment door panel--left	-	-	-	-	-	-	1	-	-	-
228196	Golf compartment door panel--right	-	-	-	-	-	-	-	1	-	-
228197	Golf compartment door panel--left	-	-	-	-	-	-	-	1	-	-
228145	Golf compartment door weatherstrip	-	-	-	-	-	-	-	2	-	-
224705	Golf compartment door weatherstrip	-	-	-	-	-	-	-	2	-	-
224712	Golf compartment door weatherstrip retainer	-	-	-	-	-	-	-	2	-	-
228147	Golf compartment door weatherstrip retainer	-	-	-	-	-	-	-	2	-	-

HASSOCK

244160	Hassock assembly (Specify set number) (With partition for 1233)	2	2	-	-	2	-	-	-	-	-
243413	Hassock assembly (Specify set number)	-	-	-	-	-	-	-	-	2	-

PARTITION

245200	Partition-back compartment lid handle	1	1	-	-	-	-	-	-	-	-
122611	Partition-back compartment lid hinge	2	2	-	-	-	-	-	-	-	-
105029	Partition-back compartment lid spring dowel	1	1	-	-	-	-	-	-	-	-
229284	Partition-back compartment lid striker plate	1	1	-	-	-	-	-	-	-	-
224195	Partition-folding seat compartment panel assembly	-	-	-	1	-	-	-	-	-	-
226026	Partition-folding seat compartment panel assembly	1	1	-	-	-	-	-	-	-	-
8202	Screw 1/4-28 x 7/8 flat hd.	4	4	-	4	-	-	-	-	-	-
235514	Partition-header clock	-	-	-	1	-	-	-	-	-	-
226789	Partition-header liner	1	1	-	-	-	-	-	-	-	-
228051	Partition-regulator handle compartment lid trimmed assembly (With partition for 1233)	1	1	-	-	-	-	-	-	-	-
226338	Partition-regulator handle compartment lid hinge	1	1	-	-	-	-	-	-	-	-
6193	Rivet 1/8 x 3/16 countersunk hd.	6	6	-	-	-	-	-	-	-	-
229261	Partition-regulator handle compartment lid knob	1	1	-	-	-	-	-	-	-	-
5497	Machine screw No. 10-32 x 1/2 oval hd.	1	1	-	-	-	-	-	-	-	-
164239	Ferrule No. 10	1	1	-	-	-	-	-	-	-	-
226025	Partition-regulator handle compartment lid striker plate	2	2	-	-	-	-	-	-	-	-
105029	Partition-regulator handle compartment lid dowel	2	2	-	-	-	-	-	-	-	-
224214	Partition-window anti-rattler front	-	-	-	3	-	-	-	-	-	-
199571	Partition-window anti-rattler rear	-	-	-	2	-	-	-	-	-	-
243502	Partition-window division channel--right	-	-	-	-	-	-	-	-	1	-
243503	Partition-window division channel--left	-	-	-	-	-	-	-	-	1	-
6159	Screw No. 8-32	-	-	-	-	-	-	-	-	4	-
245067	Partition-window finishing moulding	-	-	-	1	-	-	-	-	-	-
245180	Partition-window finishing moulding--front center	-	-	-	-	-	-	-	-	1	-
245182	Partition-window finishing moulding--front side--right	-	-	-	-	-	-	-	-	1	-

Piece No.	(17th Series) Name	No. Required									
		1232 5 P. Formal Sedan	1233 5 P. Tour. Sedan	1234 7 P. Tour. Sedan	1235 7 P. Tour. Sedan Lim.	1236 5 P. Club Sedan	1237 5 P. Coupe	1238 2-4 P. Coupe	1239 2-4 P. Conv. Coupe	1253 5 P. Conv. Sedan	1227 5 P. Victoria
245183	Partition-window finishing moulding--front side--left	-	-	-	-	-	-	-	-	1	-
245181	Partition-window finishing moulding--rear center	-	-	-	-	-	-	-	-	1	-
245184	Partition-window finishing moulding--rear side--right	-	-	-	-	-	-	-	-	1	-
245185	Partition-window finishing moulding--rear side--left	-	-	-	-	-	-	-	-	1	-
6792	Screw No. 6-40 x 1 oval hd.	-	-	-	-	-	-	-	-	10	-
235771	Partition-window finishing moulding ferrule No. 6	-	-	-	5	-	-	-	-	20	-
233719	Partition-window to folding top sponge rubber (3/4 x 7/8 x 60)	-	-	-	-	-	-	-	-	1	-
224936	Partition-window glass	1	1	-	-	-	-	-	-	-	-
227786	Partition-window glass--center	-	-	-	-	-	-	-	-	1	-
224129	Partition-window glass	-	-	-	1	-	-	-	-	-	-
236665	Partition-window glass--sides	-	-	-	-	-	-	-	-	2	-
143554	Partition-window glass cushion	1	1	-	-	-	-	-	-	-	-
243507	Partition-window glass and frame assembly ..	-	-	-	-	-	-	-	-	1	-
236668	Partition-window glass frame guide--right ..	-	-	-	-	-	-	-	-	1	-
236669	Partition-window glass frame guide--left ..	-	-	-	-	-	-	-	-	1	-
5254	Screw No. 8-32 x 5/16 oval hd.	-	-	-	-	-	-	-	-	4	-
243508	Partition-window glass frame assembly	-	-	-	-	-	-	-	-	1	-
243773	Partition-window glass frame bottom channel and lifter assembly	-	-	-	-	-	-	-	-	1	-
243505	Partition-window glass frame bottom channel bumper--long	-	-	-	-	-	-	-	-	1	-
243506	Partition-window glass frame bottom channel bumper--short	-	-	-	-	-	-	-	-	2	-
227500	Partition-window glass frame bottom corner bracket	-	-	-	-	-	-	-	-	2	-
6159	Screw No. 8-32 x 9/16 oval hd.	-	-	-	-	-	-	-	-	4	-
236671	Partition-window glass frame side channel ..	-	-	-	-	-	-	-	-	2	-
5310	Screw No. 8-32 x 1/4 rnd. hd.	-	-	-	-	-	-	-	-	4	-
5861	Washer No. 8 (Shakeproof)	-	-	-	-	-	-	-	-	4	-
243538	Partition-window glass frame side weatherstrip	-	-	-	-	-	-	-	-	2	-
236670	Partition-window glass frame top channel ..	-	-	-	-	-	-	-	-	1	-
243536	Partition-window glass frame upper center weatherstrip	-	-	-	-	-	-	-	-	1	-
243537	Partition-window glass frame upper end weatherstrip	-	-	-	-	-	-	-	-	1	-
224824	Partition-window lifter assembly	1	1	-	-	-	-	-	-	-	-
224180	Partition-window lifter assembly	-	-	-	1	-	-	-	-	-	-
224213	Partition-window lifter bumper	-	-	-	1	-	-	-	-	-	-
224432	Partition-window regulator assembly	-	-	-	1	-	-	-	-	-	-
227453	Partition-window regulator assembly	-	-	-	-	-	-	-	-	1	-
224957	Partition-window regulator assembly	1	1	-	-	-	-	-	-	-	-
243504	Partition-window regulator arm stop	-	-	-	-	-	-	-	-	2	-
245194	Partition-window regulator handle	1	1	-	1	-	-	-	-	1	-
331591	Partition-window regulator handle washer ..	1	1	-	1	-	-	-	-	1	-
245186	Partition-window regulator handle escutcheon plate	1	1	-	1	-	-	-	-	1	-
133264	Partition-window regulator handle escutcheon plate spring	1	1	-	1	-	-	-	-	1	-

Piece No.	Name	(17th Series)									
		1232 5 P. Formal Sedan	1233 5 P. Tour. Sedan	1234 7 P. Tour. Sedan	1235 7 P. Tour. Sedan Lim.	1236 5 P. Club Sedan	1237 5 P. Coupe	1238 2-4 P. Coupe	1239 2-4 P. Conv. Coupe	1253 5 P. Conv. Sedan	1227 5 P. Victoria
		No. Required									
133339	Partition-window regulator handle insert ..	1	1	-	1	-	-	-	-	1	-
132972	Partition-window regulator handle pin	1	1	-	1	-	-	-	-	1	-
224781	Partition-window runway	2	2	-	-	-	-	-	-	-	-
220696	Partition-window runway lower	-	-	-	2	-	-	-	-	-	-
227991	Partition-window runway lower	-	-	-	-	-	-	-	-	2	-
224227	Partition-window runway upper	-	-	-	1	-	-	-	-	-	-
227984	Partition-window runway upper	-	-	-	-	-	-	-	-	2	-
218826	Partition-window runway screw No. 6 x 1/2 oval hd. (Parker Kalon)	-	-	-	-	-	-	-	-	4	-
163168	Partition-window runway retainer	2	2	-	2	-	-	-	-	-	-
132429	Partition-window runway shim 1/16 x 1/2 x 40	x	x	-	x	-	-	-	-	-	-
136008	Partition-window runway shim 1/32 x 1/2 x 40	x	x	-	x	-	-	-	-	-	-
131316	Partition-window stop block bumper	2	2	-	-	-	-	-	-	-	-

REAR PILLAR

236974	Rear pillar finishing plate--right	-	-	-	-	-	-	-	-	-	1
236975	Rear pillar finishing plate--left	-	-	-	-	-	-	-	-	-	1
236730	Rear pillar finishing plate--right	-	-	-	-	-	-	-	-	1	-
236731	Rear pillar finishing plate--left	-	-	-	-	-	-	-	-	1	-
228055	Rear pillar finishing plate--right	-	-	-	-	-	-	1	-	-	-
228056	Rear pillar finishing plate--left	-	-	-	-	-	-	1	-	-	-
5766	Screw No. 6-40 x 3/8 oval hd.	-	-	-	-	-	-	8	-	-	-
6905	Screw No. 4-40 x 3/8 oval hd. (Phillips)	-	-	-	-	-	-	-	8	12	-

REAR QUARTER WINDOW

224458	Rear quarter window curtain assembly--right (Furnish sample and set number)	-	1	-	-	-	-	-	-	-	-
224459	Rear quarter window curtain assembly--left (Furnish sample and set number)	-	1	-	-	-	-	-	-	-	-
224462	Rear quarter window curtain assembly--right (Furnish sample and set number)	-	-	1	1	-	-	-	-	-	-
224463	Rear quarter window curtain assembly--left (Furnish sample and set number)	-	-	1	1	-	-	-	-	-	-
226574	Rear quarter window curtain assembly--right (Furnish sample and set number)	-	-	-	-	-	1	-	-	-	-
226575	Rear quarter window curtain assembly--left (Furnish sample and set number)	-	-	-	-	-	1	-	-	-	-
224343	Rear quarter window curtain rod assembly ..	-	2	-	-	-	-	-	-	-	-
224237	Rear quarter window curtain rod assembly ..	-	-	2	2	-	-	-	-	-	-
226526	Rear quarter window curtain rod assembly ..	-	-	-	-	-	2	-	-	-	-
36111	Rear quarter window curtain rod anti- rattler	-	4	4	4	-	4	-	-	-	-
214901	Rear quarter window curtain rod screw eye ..	-	4	4	4	-	4	-	-	-	-
224392	Rear quarter window curtain roller--right ..	-	1	-	-	-	-	-	-	-	-
224411	Rear quarter window curtain roller--left ..	-	1	-	-	-	-	-	-	-	-
224230	Rear quarter window curtain roller--right ..	-	-	1	1	-	-	-	-	-	-
224342	Rear quarter window curtain roller--left ..	-	-	1	1	-	-	-	-	-	-
226517	Rear quarter window curtain roller--right ..	-	-	-	-	-	1	-	-	-	-
226516	Rear quarter window curtain roller--left ..	-	-	-	-	-	1	-	-	-	-

(17th Series)

Piece No.	Name	No. Required									
		1232 5 P. Formal Sedan	1233 5 P. Tour. Sedan	1234 7 P. Tour. Sedan	1235 7 P. Tour. Sedan Lim.	1236 5 P. Club Sedan	1237 5 P. Coupe	1238 2-4 P. Coupe	1239 2-4 P. Conv. Coupe	1253 5 P. Conv. Sedan	1227 5 P. Victoria
224115	Rear quarter window curtain roller bracket (female) right	-	1	1	1	-	1	-	-	-	-
224309	Rear quarter window curtain roller bracket (female) left	-	1	1	1	-	1	-	-	-	-
224137	Rear quarter window curtain roller bracket (male) assembly--right	-	1	1	1	-	-	-	-	-	-
224310	Rear quarter window curtain roller bracket (male) assembly--left	-	1	1	1	-	-	-	-	-	-
170966	Rear quarter window curtain tassel	-	-	-	-	-	2	-	-	-	-
226381	Rear quarter window drain gutter	-	-	-	-	-	2	-	-	-	-
229274	Rear quarter window drain pan assembly--rt.	-	1	1	1	-	-	-	-	-	-
229273	Rear quarter window drain pan assembly--lt.	-	1	1	1	-	-	-	-	-	-
308806	Rear quarter window drain pan tube hose	-	2	2	2	-	-	-	-	-	-
245106	Rear quarter window finishing moulding--rt.	-	1	-	-	-	-	-	-	-	-
245107	Rear quarter window finishing moulding--lt.	-	1	-	-	-	-	-	-	-	-
245104	Rear quarter window finishing moulding--rt.	-	-	1	1	-	-	-	-	-	-
245105	Rear quarter window finishing moulding--lt.	-	-	1	1	-	-	-	-	-	-
245102	Rear quarter window finishing moulding--rt.	-	-	-	-	-	1	-	-	-	-
245103	Rear quarter window finishing moulding--lt.	-	-	-	-	-	1	-	-	-	-
235771	Rear quarter window finishing moulding wood screw ferrule No. 6	-	8	8	8	-	8	-	-	-	-
226054	Rear quarter window glass	-	-	-	-	-	2	-	-	-	-
224852	Rear quarter window lifter assembly--right.	-	-	-	-	-	1	-	-	-	-
224853	Rear quarter window lifter assembly--left	-	-	-	-	-	1	-	-	-	-
226050	Rear quarter window lifter bumper	-	-	-	-	-	2	-	-	-	-
224806	Rear quarter window regulator assy.--right.	-	-	-	-	-	1	-	-	-	-
224805	Rear quarter window regulator assy.--left	-	-	-	-	-	1	-	-	-	-
8214	Screw 1/4-28 x 3/4 flat hd.	-	-	-	-	-	4	-	-	-	-
8202	Screw 1/4-28 x 7/8 flat hd.	-	-	-	-	-	2	-	-	-	-
245194	Rear quarter window regulator handle	-	-	-	-	-	2	-	-	-	-
331591	Rear quarter window regulator handle washer	-	-	-	-	-	2	-	-	-	-
245186	Rear quarter window regulator handle escutcheon plate	-	-	-	-	-	2	-	-	-	-
133339	Rear quarter window regulator handle insert	-	-	-	-	-	2	-	-	-	-
132972	Rear quarter window regulator handle pin	-	-	-	-	-	2	-	-	-	-
220695	Rear quarter window runway lower	-	-	-	-	-	4	-	-	-	-
226056	Rear quarter window runway upper	-	-	-	-	-	2	-	-	-	-
163168	Rear quarter window runway retainer	-	-	-	-	-	6	-	-	-	-
136008	Rear quarter window runway shim 1/32 x 1/2 x 40"	-	-	-	-	-	x	-	-	-	-
132429	Rear quarter window runway shim 1/16 x 1/2 x 40"	-	-	-	-	-	x	-	-	-	-
220660	Rear quarter window wing assembly--right	-	1	-	-	-	-	-	-	-	-
220661	Rear quarter window wing assembly--left	-	1	-	-	-	-	-	-	-	-
220662	Rear quarter window wing assembly--right	-	-	1	1	-	-	-	-	-	-
220663	Rear quarter window wing assembly--left	-	-	1	1	-	-	-	-	-	-
220565	Rear quarter window wing glass	-	2	-	-	-	-	-	-	-	-
220574	Rear quarter window wing glass	-	-	2	2	-	-	-	-	-	-
220579	Rear quarter window wing glass and glass retainer assembly	-	2	-	-	-	-	-	-	-	-
220571	Rear quarter window wing glass and glass retainer assembly	-	-	2	2	-	-	-	-	-	-
228272	Rear quarter window wing glass cushion 1/16" thick	-	x	x	x	-	-	-	-	-	-

Piece No.	Name	(17th Series)									
		1232 5 P. Formal Sedan	1233 5 P. Tour. Sedan	1234 7 P. Tour. Sedan	1235 7 P. Tour. Sedan Lim.	1236 5 P. Club Sedan	1237 5 P. Coupe	1238 2-4 P. Coupe	1239 2-4 P. Conv. Coupe	1253 5 P. Conv. Sedan	1227 5 P. Victoria
		No. Required									
229324	Rear quarter window wing glass cushion .080 x 1-1/2 everseal	-	x	x	x	-	-	-	-	-	-
211649	Rear quarter window wing glass cushion 3/32 x 1-1/2 everseal	-	x	x	x	-	-	-	-	-	-
220562	Rear quarter window wing glass retainer assembly front	-	2	-	-	-	-	-	-	-	-
220573	Rear quarter window wing glass retainer assembly--front	-	-	2	2	-	-	-	-	-	-
220560	Rear quarter window wing glass retainer assembly--rear	-	2	-	-	-	-	-	-	-	-
220572	Rear quarter window wing glass retainer assembly--rear	-	-	2	2	-	-	-	-	-	-
212366	Rear quarter window wing glass retainer assembly--rear screw No. 4 x 3/16 (Parker Kalon)	-	4	4	4	-	-	-	-	-	-
220600	Rear quarter window wing glass retainer pivot lower spacer	-	x	x	x	-	-	-	-	-	-
212490	Rear quarter window wing glass retainer pivot upper spring	-	2	2	2	-	-	-	-	-	-
220580	Rear quarter window wing glass retainer pivot upper spring plate	-	2	-	-	-	-	-	-	-	-
220576	Rear quarter window wing glass retainer pivot upper spring plate	-	-	2	2	-	-	-	-	-	-
140174	Rear quarter window wing glass retainer pivot upper spring plate screw No. 10-24 x 5/16 flat hd.	-	4	4	4	-	-	-	-	-	-
220643	Rear quarter window wing regulator assembly--right	-	1	1	1	-	-	-	-	-	-
220644	Rear quarter window wing regulator assembly--left	-	1	1	1	-	-	-	-	-	-
7837	Screw 1/4-20 x 7/8 hex. hd.	-	4	4	4	-	-	-	-	-	-
5502	Lockwasher 1/4	-	4	4	4	-	-	-	-	-	-
245195	Rear quarter window wing regulator handle	-	2	2	2	-	-	-	-	-	-
331591	Rear quarter window wing regulator handle washer	-	2	2	2	-	-	-	-	-	-
245193	Rear quarter window wing regulator handle escutcheon plate	-	2	2	2	-	-	-	-	-	-
133339	Rear quarter window wing regulator handle insert	-	2	2	2	-	-	-	-	-	-
147910	Rear quarter window wing regulator handle screw	-	2	2	2	-	-	-	-	-	-
229282	Rear quarter window wing regulator shaft washer	-	2	2	2	-	-	-	-	-	-
220588	Rear quarter window wing weatherstrip assembly--right	-	1	-	-	-	-	-	-	-	-
220587	Rear quarter window wing weatherstrip assembly--left	-	1	-	-	-	-	-	-	-	-
220582	Rear quarter window wing weatherstrip assembly--right	-	-	1	1	-	-	-	-	-	-
220583	Rear quarter window wing weatherstrip assembly--left	-	-	1	1	-	-	-	-	-	-
220585	Rear quarter window wing weatherstrip retainer--left	-	1	-	-	-	-	-	-	-	-
220586	Rear quarter window wing weatherstrip retainer--right	-	1	-	-	-	-	-	-	-	-

Piece No.	Name	(17th Series)									
		1232 5 P. Formal Sedan	1233 5 P. Tour. Sedan	1234 7 P. Tour. Sedan	1235 7 P. Tour. Sedan Lim	1236 5 P. Club Sedan	1237 5 P. Coupe	1238 2-4 P. Coupe	1239 2-4 P. Conv. Coupe	1253 5 P. Conv. Sedan	1227 5 P. Victoria
		No. Required									
220558	Rear quarter window wing weatherstrip retainer--right.....	-	-	1	1	-	-	-	-	-	-
220559	Rear quarter window wing weatherstrip retainer--left	-	-	1	1	-	-	-	-	-	-

REAR SEAT

227600	Rear seat adjusting handle	-	-	-	-	-	-	-	-	-	1
236773	Rear seat back frame hinge assembly	-	-	-	-	-	-	-	-	2	-
236029	Rear seat hinge--female	-	-	-	-	-	-	-	-	-	2
236028	Rear seat back hinge--male	-	-	-	-	-	-	-	-	-	2
5827	Screw 1/4-28 x 1 flat hd.	-	-	-	-	-	-	-	-	-	27
7526	Rear seat back hinge clevis pin	-	-	-	-	-	-	-	-	-	2
4290	Rear seat back hinge cotter pin 3/32 x 5/8.	-	-	-	-	-	-	-	-	-	2
236858	Rear seat back link to body bracket--right.	-	-	-	-	-	-	-	-	-	1
236859	Rear seat back link to body bracket--left .	-	-	-	-	-	-	-	-	-	1
227275	Rear seat back lock guide plate	-	-	-	-	-	-	-	-	1	-
227290	Rear seat back lock rod	-	-	-	-	-	-	-	-	1	-
227289	Rear seat back lock rod guide	-	-	-	-	-	-	-	-	1	-
3883	Washer 7/16" plain	-	-	-	-	-	-	-	-	1	-
5728	Lockwasher 7/16	-	-	-	-	-	-	-	-	1	-
62065	Washer 1/4" plain	-	-	-	-	-	-	-	-	1	-
4280	Cotter pin 1/16 x 1/2	-	-	-	-	-	-	-	-	1	-
227288	Rear seat back lock rod knob	-	-	-	-	-	-	-	-	1	-
227286	Rear seat back lock spring	-	-	-	-	-	-	-	-	1	-
245268	Rear seat back lock striker	-	-	-	-	-	-	-	-	1	-
235746	Rear seat back spring--right	1	1	1	1	-	-	-	-	-	-
236744	Rear seat back spring--right	-	-	-	-	-	-	-	-	-	1
224489	Rear seat back spring--right	-	-	-	-	1	-	-	-	-	-
224789	Rear seat back spring--right	-	-	-	-	-	1	-	-	-	-
236788	Rear seat back spring--right	-	-	-	-	-	-	-	-	1	-
235747	Rear seat back spring--left	1	1	1	1	-	-	-	-	-	-
236745	Rear seat back spring--left	-	-	-	-	-	-	-	-	-	1
224490	Rear seat back spring--left	-	-	-	-	1	-	-	-	-	-
224790	Rear seat back spring--left	-	-	-	-	-	1	-	-	-	-
236789	Rear seat back spring--left	-	-	-	-	-	-	-	-	1	-
241496	Rear seat back to trim frame rod and link assembly	-	-	-	-	-	-	-	-	-	1
241371	Rear seat back to trim frame link screw ...	-	-	-	-	-	-	-	-	-	2
243180	Rear seat cushion (trimmed) assembly	-	-	-	-	-	-	-	-	-	1
243139	Rear seat cushion (trimmed) assembly	-	-	-	-	-	-	-	-	1	-
244149	Rear seat cushion (trimmed) assembly	1	1	1	1	-	-	-	-	-	-
244150	Rear seat cushion (trimmed) assembly	-	-	-	-	1	-	-	-	-	-
244151	Rear seat cushion (trimmed) assembly	-	-	-	-	-	1	-	-	-	-
236177	Rear seat cushion dowel--female	-	-	-	-	-	-	-	-	-	4
224267	Rear seat cushion dowel--male	-	-	-	-	-	-	-	-	-	4
235748	Rear seat cushion spring	1	1	1	1	-	-	-	-	-	-
236748	Rear seat cushion spring	-	-	-	-	-	-	-	-	-	1
224488	Rear seat cushion spring	-	-	-	-	1	-	-	-	-	-
224794	Rear seat cushion spring	-	-	-	-	-	1	-	-	-	-
236783	Rear seat cushion spring	-	-	-	-	-	-	-	-	1	-
231551	Rear seat folding arm rest assy.--untrimmed	1	1	1	1	1	-	-	-	-	-
231817	Rear seat folding arm rest assy.--untrimmed	-	-	-	-	-	1	-	-	-	-
236985	Rear seat folding arm rest assy.--untrimmed	-	-	-	-	-	-	-	-	1	-

Piece No.	Name	(17th Series)										
		1232 5 P. Formal Sedan	1233 5 P. Tour. Sedan	1234 7 P. Tour. Sedan	1235 7 P. Tour. Sedan Lim.	1236 5 P. Club Sedan	1237 5 P. Coupe	1238 2-4 P. Coupe	1239 2-4 P. Conv. Coupe	1253 5 P. Conv. Sedan	1227 5 P. Victoria	
		No. Required										
235226	Rear seat folding arm rest assy.--untrimmed	-	-	-	-	-	-	-	-	-	-	1
212602	Rear seat folding arm rest cushion	1	1	1	1	1	1	-	-	-	1	1
224918	Rear seat folding arm rest cushion spacer .	-	-	-	-	-	1	-	-	-	-	1
224082	Rear seat folding arm rest pivot screw	4	4	4	4	4	4	-	-	-	-	-
311143	Rear seat folding arm rest pivot screw	4	4	4	4	4	4	-	-	-	4	4
7837	Rear seat folding arm rest pivot screw 1/4-20 x 7/8 hex. hd.	-	-	-	-	-	-	-	-	-	4	4
62065	Washer 1/4	4	4	4	4	4	4	-	-	-	-	-
311144	Spacer	4	4	4	4	4	4	-	-	-	4	4
5502	Lockwasher 1/4	8	8	8	8	8	8	-	-	-	8	8
211648	Nut 1/4-28	8	8	8	8	8	8	-	-	-	4	4
211809	Spring washer	8	8	8	8	8	8	-	-	-	4	4
235960	Rear seat folding arm rest spring	1	1	1	1	1	-	-	-	-	-	-
236782	Rear seat folding arm rest spring	-	-	-	-	-	-	-	-	-	1	-
241076	Rear seat folding arm rest spring	-	-	-	-	-	1	-	-	-	-	-
236747	Rear seat folding arm rest spring	-	-	-	-	-	-	-	-	-	-	1

REAR VIEW MIRROR

235759	Rear view mirror	1	1	1	1	1	1	1	1	1	1	1
224332	Rear view mirror assembly screw No. 8-32 x 5/16 rnd. hd. special	2	2	2	2	2	2	2	2	2	2	2

REAR WINDOW

224214	Rear window anti-rattler (inside)	-	-	-	-	-	-	1	-	-	-	-
224214	Rear window anti-rattler (outside)	-	-	-	-	-	-	1	-	-	-	-
228314	Rear window curtain assembly	1	-	-	-	-	-	-	-	-	-	-
228312	Rear window curtain assembly	-	1	1	1	1	1	1	-	-	-	-
226309	Rear window curtain finger pull	1	1	1	1	1	1	1	-	-	-	-
220984	Rear window curtain hook	1	1	1	1	1	1	1	-	-	-	-
220972	Rear window curtain rod assembly	-	1	1	1	1	1	1	-	-	-	-
226524	Rear window curtain rod assembly	1	-	-	-	-	-	-	-	-	-	-
228156	Rear window curtain roller assembly	1	-	-	-	-	-	-	-	-	-	-
228155	Rear window curtain roller assembly	-	1	1	1	1	1	1	-	-	-	-
228158	Rear window curtain roller bracket (female)	1	1	1	1	1	1	1	-	-	-	-
228157	Rear window curtain roller bracket (male)	1	1	1	1	1	1	1	-	-	-	-
245007	Rear window finishing moulding assembly ...	-	1	1	1	1	1	-	-	-	-	-
245052	Rear window finishing moulding	1	-	-	-	-	-	-	-	-	-	-
245006	Rear window finishing moulding assembly ...	-	-	-	-	-	-	1	-	-	-	-
6766	Screw No. 6 x 7/8 oval hd. (Phillips Sheet Metal	-	4	4	4	4	4	-	-	-	-	-
235771	Rear window finishing moulding wood screw ferrule No. 6	4	4	4	4	4	4	4	-	-	-	-
220872	Rear window finishing rim	-	1	1	1	1	1	-	-	-	-	-
220924	Rear window glass	-	1	1	1	1	1	-	-	-	-	-
226057	Rear window glass	1	-	-	-	-	-	-	-	-	-	-
226223	Rear window glass	-	-	-	-	-	-	1	-	-	-	-
229808	Rear window glass cushion	-	1	1	1	1	1	-	-	-	-	-
226305	Rear window glass cushion	1	-	-	-	-	-	-	-	-	-	-
226203	Rear window glass retainer	1	-	-	-	-	-	-	-	-	-	-
229807	Rear window glass retainer	-	1	1	1	1	1	-	-	-	-	-

Piece No.	(17th Series) Name	No. Required									
		1232 5 P. Formal Sedan	1233 5 P. Tour. Sedan	1234 7 P. Tour. Sedan	1235 7 P. Tour. Sedan Lim	1236 5 P. Club Sedan	1237 5 P. Coupe	1238 2-4 P. Coupe	1239 2-4 P. Conv. Coupe	1253 5 P. Conv. Sedan	1227 5 P. Victoria
308802	Screw No. 6 x 3/8 binding hd. (Parker Kalon)	-	13	13	13	13	13	-	-	-	-
226231	Rear window lifter assembly	-	-	-	-	-	-	1	-	-	-
226235	Rear window lifter bumper	-	-	-	-	-	-	1	-	-	-
226236	Rear window regulator assembly	-	-	-	-	-	-	1	-	-	-
245196	Rear window regulator handle	-	-	-	-	-	-	1	-	-	-
243979	Rear window regulator handle escutcheon plate	-	-	-	-	-	-	1	-	-	-
147910	Rear window regulator handle screw	-	-	-	-	-	-	1	-	-	-
133339	Rear window regulator handle insert	-	-	-	-	-	-	1	-	-	-
331591	Rear window regulator handle washer	-	-	-	-	-	-	1	-	-	-
226274	Rear window runway lower	-	-	-	-	-	-	2	-	-	-
226273	Rear window runway upper	-	-	-	-	-	-	1	-	-	-
163168	Rear window runway retainer	-	-	-	-	-	-	2	-	-	-
136008	Rear window runway shim 1/32 x 1/2 x 40" ..	-	-	-	-	-	-	x	-	-	-
132429	Rear window runway shim 1/16 x 1/2 x 40" ..	-	-	-	-	-	-	x	-	-	-

ROBE RAIL

235329	Robe rail assembly (Specify set number) (With partition for 1233)	1	1	-	-	-	-	-	-	-	-
337746	Robe rail assembly (cloth) (Specify set number)	-	1	1	1	1	-	-	-	-	-
245330	Robe rail assembly (Specify set number) ...	-	-	-	-	-	-	-	1	-	-
5806	Robe rail assembly stud lockwasher 7/16 ...	2	2	2	-	2	-	-	-	-	-
6574	Lockwasher 9/16 (Shakeproof)	-	-	-	2	-	-	-	2	-	-
243612	Nut 7/16-14	2	2	2	-	2	-	-	-	-	-
337743	Nut	-	-	-	2	-	-	-	2	-	-

ROOF

226002	Roof joint moulding (60" long)	1	-	-	-	-	-	-	-	-	-
226006	Roof joint moulding (100-1/2" long)	-	2	-	-	-	-	-	-	-	-
220883	Roof joint moulding (105-1/2" long)	-	-	2	2	-	-	-	-	-	-
226005	Roof joint moulding (91-1/2" long)	-	-	-	-	2	-	-	-	-	-
226004	Roof joint moulding (82" long)	-	-	-	-	-	2	-	-	-	-
226003	Roof joint moulding (59-1/2" long)	-	-	-	-	-	-	2	-	-	-
235344	Roof-radio antenna lead in cable assembly ..	2	1	1	1	1	1	1	-	-	-
224948	Roof rain gutter moulding right (86" long) ..	1	-	-	-	-	-	-	-	-	-
235442	Roof rain gutter moulding--right	-	1	-	-	-	-	-	-	-	-
235444	Roof rain gutter moulding--right	-	-	1	1	-	-	-	-	-	-
235446	Roof rain gutter moulding--right	-	-	-	-	1	-	-	-	-	-
235448	Roof rain gutter moulding--right	-	-	-	-	-	1	-	-	-	-
235450	Roof rain gutter moulding--right	-	-	-	-	-	-	1	-	-	-
228329	Roof rain gutter moulding--left (86" long) ..	1	-	-	-	-	-	-	-	-	-
235443	Roof rain gutter moulding--left	-	1	-	-	-	-	-	-	-	-
235445	Roof rain gutter moulding--left	-	-	1	1	-	-	-	-	-	-
235447	Roof rain gutter moulding--left	-	-	-	-	1	-	-	-	-	-
235449	Roof rain gutter moulding--left	-	-	-	-	-	1	-	-	-	-
235451	Roof rain gutter moulding--left	-	-	-	-	-	-	1	-	-	-
235511	Roof rain gutter moulding screw No. 4 x 1/4 Asco flat hd. (self tapping)	-	x	x	x	x	x	x	-	-	-

(17th Series)

Piece No.

Name

1232 5 P. Formal Sedan
 1233 8 P. Tour. Sedan
 1234 7 P. Tour. Sedan
 1235 7 P. Tour. Sedan Lim.
 1236 5 P. Club Sedan
 1237 5 P. Coupe
 1238 2-4 P. Coupe
 1239 2-4 P. Conv. Coupe
 1253 5 P. Conv. Sedan
 1227 5 P. Victoria

No. Required

RUMBLE SEAT

226335	Rumble seat back spring (Luxury type)	-	-	-	-	-	-	1	1	-	-
224718	Rumble seat compartment door hinge--right .	-	-	-	-	-	-	1	1	-	-
224719	Rumble seat compartment door hinge--left ..	-	-	-	-	-	-	1	1	-	-
5909	Screw 5/16-24 x 1-1/2 hex. hd.	-	-	-	-	-	-	4	4	-	-
5504	Lockwasher 5/16	-	-	-	-	-	-	6	6	-	-
7005	Nut 5/16-24	-	-	-	-	-	-	2	2	-	-
6305	Stud 5/16	-	-	-	-	-	-	2	2	-	-
224716	Rumble seat compartment door hinge bracket right	-	-	-	-	-	-	1	1	-	-
224717	Rumble seat compartment door hinge bracket left	-	-	-	-	-	-	1	1	-	-
7613	Bolt 1/4-28 x 1-3/4 carriage	-	-	-	-	-	-	4	4	-	-
7004	Nut 1/4-28	-	-	-	-	-	-	4	4	-	-
5502	Lockwasher 1/4	-	-	-	-	-	-	4	4	-	-
8222	Screw 3/8-24 x 1 flat hd.	-	-	-	-	-	-	4	4	-	-
7006	Nut 3/8-24	-	-	-	-	-	-	4	4	-	-
5506	Lockwasher 3/8	-	-	-	-	-	-	4	4	-	-
127501	Rumble seat compartment door hinge bushing.	-	-	-	-	-	-	2	2	-	-
127498	Rumble seat compartment door hinge screw ..	-	-	-	-	-	-	2	2	-	-
3884	Washer 1/2	-	-	-	-	-	-	2	2	-	-
5510	Lockwasher 1/2	-	-	-	-	-	-	2	2	-	-
157584	Rumble seat compartment door operating bolt	-	-	-	-	-	-	2	2	-	-
7104	Nut 1/4-28 castle	-	-	-	-	-	-	2	2	-	-
4280	Cotter pin 1/16 x 1/2	-	-	-	-	-	-	2	2	-	-
196243	Rumble seat compartment door operating spring	-	-	-	-	-	-	2	2	-	-
157585	Rumble seat compartment door operating spring washer	-	-	-	-	-	-	2	2	-	-
224715	Rumble seat compartment door panel	-	-	-	-	-	-	1	1	-	-
235348	Rumble seat compartment door weatherstrip .	-	-	-	-	-	-	1	1	-	-
224961	Rumble seat compartment drain gutter assy..	-	-	-	-	-	-	1	1	-	-
233528	Rumble seat cushion assembly	-	-	-	-	-	-	1	1	-	-
235279	Rumble seat cushion spring	-	-	-	-	-	-	1	1	-	-
148338	Rumble seat door lock	-	-	-	-	-	-	1	1	-	-
229393	Rumble seat door lock bolt weatherstrip ...	-	-	-	-	-	-	1	1	-	-
228127	Rumble seat door lock operating bell crank yoke and clip assembly--front	-	-	-	-	-	-	-	1	-	-
228129	Rumble seat door lock operating bell crank yoke and clip assembly--rear	-	-	-	-	-	-	-	1	-	-
229392	Rumble seat door lock operating bell crank clip	-	-	-	-	-	-	-	4	-	-
228128	Rumble seat door lock operating bell crank rod--front	-	-	-	-	-	-	-	1	-	-
228130	Rumble seat door lock operating bell crank rod--rear	-	-	-	-	-	-	-	1	-	-
3907	Washer 1/4 plain	-	-	-	-	-	-	-	4	-	-
228139	Rumble seat door lock operating knob	-	-	-	-	-	-	-	1	-	-
226960	Rumble seat door lock operating knob ferrule	-	-	-	-	-	-	-	1	-	-
226961	Rumble seat door lock operating knob ferrule clinch plate	-	-	-	-	-	-	-	1	-	-
224831	Rumble seat door lock operating lever	-	-	-	-	-	-	1	-	-	-
228137	Rumble seat door lock operating rod yoke and clip assembly--front	-	-	-	-	-	-	-	1	-	-

Piece No.	Name	(17th Series)									
		1232 5 P. Formal Sedan	1233 5 P. Tour. Sedan	1234 7 P. Tour. Sedan	1235 7 P. Tour. Sedan Lim.	1236 5 P. Club Sedan	1237 5 P. Coupe	1238 2-4 P. Coupe	1239 2-4 P. Conv. Coupe	1239 5 P. Conv. Sedan	1227 5 P. Victoria
		No. Required									
173411	Rumble seat door lock operating rod and yoke end assembly	-	-	-	-	-	-	1	-	-	-
228149	Rumble seat door lock operating rod and yoke end assembly--rear	-	-	-	-	-	-	-	1	-	-
228135	Rumble seat door lock operating rod and yoke end assembly--side	-	-	-	-	-	-	-	1	-	-
7513	Yoke end adjustor 3/16	-	-	-	-	-	-	1	2	-	-
7003	Nut No. 10-32	-	-	-	-	-	-	1	2	-	-
7523	Yoke end pin 3/16	-	-	-	-	-	-	3	5	-	-
3906	Washer 3/16 "Y" standard	-	-	-	-	-	-	2	-	-	-
4690	Cotter pin 1/16 x 3/8	-	-	-	-	-	-	3	5	-	-
228142	Rumble seat door lock operating rod front clip	-	-	-	-	-	-	-	2	-	-
228143	Rumble seat door lock operating rod side clip	-	-	-	-	-	-	-	1	-	-
157625	Rumble seat door lock striker	-	-	-	-	-	-	1	1	-	-
226513	Rumble seat step upper gasket	-	-	-	-	-	-	1	1	-	-
226512	Rumble seat step upper mat	-	-	-	-	-	-	1	1	-	-
226512	Rumble seat step lower mat	-	-	-	-	-	-	1	1	-	-
226510	Rumble seat step upper assembly	-	-	-	-	-	-	1	1	-	-
5666	Stud 3/8	-	-	-	-	-	-	2	2	-	-
114055	Washer	-	-	-	-	-	-	2	2	-	-
5506	Lockwasher 3/8	-	-	-	-	-	-	2	2	-	-
7006	Nut 3/8-24	-	-	-	-	-	-	2	2	-	-
235222	Rumble seat step lower assembly	-	-	-	-	-	-	1	1	-	-
7804	Screw 5/16-18 x 3/4 hex. hd.	-	-	-	-	-	-	2	2	-	-
5504	Lockwasher 5/16"	-	-	-	-	-	-	2	2	-	-
235128	Rumble seat step lower bracket	-	-	-	-	-	-	1	1	-	-
310638	Rumble seat step lower bracket nut	-	-	-	-	-	-	1	1	-	-
220881	Lockwasher 3/4 (Shakeproof)	-	-	-	-	-	-	1	1	-	-

SUN VISOR

325936	Sun visor--complete	-	-	-	-	-	-	-	2	2	2
245203	Sun visor assembly	2	2	2	2	2	2	2	-	-	-
245206	Sun visor hinge bracket assembly--right ...	1	1	1	1	1	1	1	-	-	-
245207	Sun visor hinge bracket assembly--left	1	1	1	1	1	1	1	-	-	-
235770	Screw 1/4-28 x 5/8 oval hd. (Phillip-conical point)	4	4	4	4	4	4	4	-	-	-

TOP

241242	Top assembly--less fabric	-	-	-	-	-	-	-	-	1	-
241243	Top assembly--less fabric	-	-	-	-	-	-	-	-	-	1
241089	Top assembly--less fabric	-	-	-	-	-	-	-	1	-	-
0243695	Top bow No. 2	-	-	-	-	-	-	-	-	1	-
236661	Top bow auxiliary	-	-	-	-	-	-	-	-	1	-
0243626	Top bow auxiliary	-	-	-	-	-	-	-	-	-	1
0328570	Top bow auxiliary to rear bow seat ironbolt	-	-	-	-	-	-	-	-	2	2
229595	Top envelope assembly	-	-	-	-	-	-	-	1	-	-
243199	Top envelope assembly	-	-	-	-	-	-	-	-	-	1
243115	Top envelope assembly	-	-	-	-	-	-	-	-	1	-
0243642	Top folding pillar bracket upper right	-	-	-	-	-	-	-	1	-	-

Piece No.	Name	(17th Series)										
		1232 5 P. Formal Sedan	1233 5 P. Tour. Sedan	1234 7 P. Tour. Sedan	1235 7 P. Tour. Sedan Lim.	1236 5 P. Club Sedan	1237 5 P. Coupe	1238 2-4 P. Coupe	1239 2-4 P. Conv. Coupe	1253 5 P. Conv. Sedan	1227 5 P. Victoria	
		No. Required										
0243643	Top folding pillar bracket upper left	-	-	-	-	-	-	-	-	1	-	-
0243650	Top folding pillar bracket to side rail shoulder bolt	-	-	-	-	-	-	-	-	2	-	-
228177	Top folding pillar bumper	-	-	-	-	-	-	-	-	X	-	-
228094	Top folding pillar hinge--right	-	-	-	-	-	-	-	-	1	-	-
228095	Top folding pillar hinge--left	-	-	-	-	-	-	-	-	1	-	-
236624	Top folding pillar hinge--right	-	-	-	-	-	-	-	-	-	1	-
236625	Top folding pillar hinge--left	-	-	-	-	-	-	-	-	-	1	-
236856	Top folding pillar hinge--right	-	-	-	-	-	-	-	-	-	-	1
236857	Top folding pillar hinge--left	-	-	-	-	-	-	-	-	-	-	1
235244	Top folding pillar hinge bracket--right ...	-	-	-	-	-	-	-	-	1	-	-
235245	Top folding pillar hinge bracket--left	-	-	-	-	-	-	-	-	1	-	-
236632	Top folding pillar hinge bracket--right ...	-	-	-	-	-	-	-	-	-	1	-
236633	Top folding pillar hinge bracket--left	-	-	-	-	-	-	-	-	-	1	-
236854	Top folding pillar hinge bracket--right ...	-	-	-	-	-	-	-	-	-	-	1
236855	Top folding pillar hinge bracket--right ...	-	-	-	-	-	-	-	-	-	-	1
8204	Screw 1/4-28 x 2 flat hd.	-	-	-	-	-	-	-	-	2	-	-
6852	Screw No. 12-24 x 1-5/8 flat hd.	-	-	-	-	-	-	-	-	-	4	-
6851	Screw No. 12-24 x 1 flat hd.	-	-	-	-	-	-	-	-	-	6	6
6853	Screw No. 12-24 x 2-1/4 flat hd.	-	-	-	-	-	-	-	-	-	2	4
228069	Top folding pillar hinge pin	-	-	-	-	-	-	-	-	2	-	-
227660	Top folding pillar hinge pin	-	-	-	-	-	-	-	-	-	2	2
236024	Top folding pillar pad--right	-	-	-	-	-	-	-	-	-	1	-
236025	Top folding pillar pad--left	-	-	-	-	-	-	-	-	-	1	-
0243614	Top front cross bar	-	-	-	-	-	-	-	-	1	1	1
0243618	Top front cross bar bracket side--right ...	-	-	-	-	-	-	-	-	1	-	-
0243786	Top front cross bar bracket side--right ...	-	-	-	-	-	-	-	-	-	1	-
0243619	Top front cross bar bracket side--left	-	-	-	-	-	-	-	-	1	-	-
0243787	Top front cross bar bracket side--left	-	-	-	-	-	-	-	-	-	1	-
0243652	Top front cross bar bracket side dowel pin.	-	-	-	-	-	-	-	-	2	2	2
0243633	Top front cross bar clamp adjusting bracket	-	-	-	-	-	-	-	-	3	3	3
0243636	Top front cross bar clamp bracket--center .	-	-	-	-	-	-	-	-	1	1	1
0243652	Top front cross bar clamp bracket center dowel	-	-	-	-	-	-	-	-	1	1	1
0241423	Top front cross bar clamp handle to adjust- ing bracket pin	-	-	-	-	-	-	-	-	6	6	6
0241426	Top front cross bar clamp handle	-	-	-	-	-	-	-	-	3	3	3
0241425	Top front cross bar clamp handle to link pin	-	-	-	-	-	-	-	-	3	3	3
0241419	Top front cross bar clamp link	-	-	-	-	-	-	-	-	3	3	3
227754	Top hold down clamp assembly--right (at removable pillar)	-	-	-	-	-	-	-	-	-	1	-
227755	Top hold down clamp assembly--left (at removable pillar)	-	-	-	-	-	-	-	-	-	1	-
6817	Screw No. 8-32 x 3/8 Phillips (oval hd.)	-	-	-	-	-	-	-	-	-	4	-
5312	Screw No. 8-32 x 3/8 oval hd.	-	-	-	-	-	-	-	-	-	12	-
0243645	Top main bow	-	-	-	-	-	-	-	-	1	-	-
0243698	Top main bow	-	-	-	-	-	-	-	-	-	1	-
0243653	Top main bow	-	-	-	-	-	-	-	-	-	-	1
0243640	Top prop and rear bow slat and clevis handle assembly--right	-	-	-	-	-	-	-	-	1	-	-
0243641	Top prop and rear bow slat and clevis handle assembly--left	-	-	-	-	-	-	-	-	1	-	-
0243651	Top prop to side rail shoulder bolt	-	-	-	-	-	-	-	-	2	-	-
229440	Top prop to body bracket assembly--right ..	-	-	-	-	-	-	-	-	1	-	-
229441	Top prop to body bracket assembly--left ...	-	-	-	-	-	-	-	-	1	-	-

(17th Series)

Piece No.	Name	No. Required								
		1232 5 P. Formal Sedan	1233 5 P. Tour. Sedan	1234 7 P. Tour. Sedan	1235 7 P. Tour. Sedan Lim.	1236 5 P. Club Sedan	1237 5 P. Coupe	1238 2-4 F. Coupe	1239 2-4 P. Conv. Coupe	1253 5 P. Conv. Sedan
4163	Rivet	-	-	-	-	-	-	4	-	-
236853	Top prop to body bracket	-	-	-	-	-	-	-	-	2
236069	Top prop to body bracket	-	-	-	-	-	-	-	-	2
6303	Screw 1/4-28 x 1/2 oval hd.	-	-	-	-	-	-	-	-	8
236777	Top prop pivot screw	-	-	-	-	-	-	2	2	2
236776	Top prop pivot screw nut (serrated)	-	-	-	-	-	-	2	2	2
3877	Washer 3/8	-	-	-	-	-	-	2	2	2
0243637	Top rear bow	-	-	-	-	-	-	1	-	-
236325	Top rear bow	-	-	-	-	-	-	-	1	-
0243628	Top rear bow	-	-	-	-	-	-	-	-	1
229593	Top rear curtain assembly	-	-	-	-	-	-	1	-	-
243211	Top rear curtain assembly	-	-	-	-	-	-	-	-	1
243116	Top rear curtain assembly	-	-	-	-	-	-	-	1	-
227579	Top rear window glass	-	-	-	-	-	-	1	-	-
313561	Top rear window glass	-	-	-	-	-	-	-	1	1
313563	Top rear window glass frame--inner	-	-	-	-	-	-	-	1	1
313562	Top rear window glass frame--outer	-	-	-	-	-	-	-	1	1
6786	Screw No. 6-32 x 3/8 oval hd. (Phillips)	-	-	-	-	-	-	-	16	16
179131	Top rear window glass frame	-	-	-	-	-	-	1	-	-
325919	Top rear window glass weatherstrip	-	-	-	-	-	-	-	1	1
236104	Top removable center pillar on body dove- tail--right (Not used with partition) ...	-	-	-	-	-	-	-	1	-
236105	Top removable center pillar on body dove- tail--left (Not used with partition)	-	-	-	-	-	-	-	1	-
6544	Screw 1/4-20 x 1/2 flat hd.	-	-	-	-	-	-	-	8	-
243500	Top removable center pillar on dovetail-- right (Used with partition)	-	-	-	-	-	-	-	1	-
243501	Top removable center pillar on body dove- tail--left (Used with partition)	-	-	-	-	-	-	-	1	-
236106	Top removable center pillar on pillar dovetail--right	-	-	-	-	-	-	-	1	-
236107	Top removable center pillar on pillar dovetail--left	-	-	-	-	-	-	-	1	-
236673	Top removable center pillar on pillar dovetail thumbscrew	-	-	-	-	-	-	-	2	-
236108	Top removable center pillar top lock- plate--right	-	-	-	-	-	-	-	1	-
236109	Top removable center pillar top lock- plate--left	-	-	-	-	-	-	-	1	-
236166	Top removable center pillar pad upper--rt..	-	-	-	-	-	-	-	1	-
236167	Top removable center pillar pad upper--lt..	-	-	-	-	-	-	-	1	-
236132	Top removable center pillar pad lower--rt..	-	-	-	-	-	-	-	1	-
236133	Top removable center pillar pad lower--lt..	-	-	-	-	-	-	-	1	-
236690	Top removable center pillar pad retainer-- upper--right	-	-	-	-	-	-	-	1	-
236691	Top removable center pillar pad retainer-- upper--left	-	-	-	-	-	-	-	1	-
0243631	Top side rail assembly--rear	-	-	-	-	-	-	2	-	-
227765	Top side rail bumper--center	-	-	-	-	-	-	-	2	-
0243704	Top side rail bumper plate--front	-	-	-	-	-	-	-	2	-
0243705	Top side rail bumper plate--rear	-	-	-	-	-	-	-	2	-
0243622	Top side rail front and bracket assembly-- right	-	-	-	-	-	-	1	-	-

(17th Series)

Piece No.	Name	No. Required									
		1232 5 P. Formal Sedan	1233 5 P. Tour. Sedan	1234 7 P. Tour. Sedan	1235 7 P. Tour. Sedan Lim.	1236 5 P. Club Sedan	1237 5 P. Coupe	1238 2-4 P. Coupe	1239 2-4 P. Conv Coupe	1253 5 P. Conv Sedan	1227 5 P. Victoria
0243623	Top side rail front and bracket assembly--left	-	-	-	-	-	-	-	1	-	-
0243625	Top side rail hinge clamp assembly	-	-	-	-	-	-	-	2	2	-
0243627	Top side rail hinge clamp catch	-	-	-	-	-	-	-	2	2	-
0243644	Top side rail hinge clamp catch tapping plate	-	-	-	-	-	-	-	2	2	-
0243706	Top side rail locking dowel plate--right	-	-	-	-	-	-	-	-	1	-
0243707	Top side rail locking dowel plate--left	-	-	-	-	-	-	-	-	1	-
0243620	Top side rail link to front cross bar bracket--right	-	-	-	-	-	-	-	1	-	-
0243621	Top side rail link to front cross bar bracket--left	-	-	-	-	-	-	-	1	-	-
0243708	Top slat iron assembly--right	-	-	-	-	-	-	-	-	1	-
0243654	Top slat iron assembly--right	-	-	-	-	-	-	-	-	-	1
0243709	Top slat iron assembly--left	-	-	-	-	-	-	-	-	1	-
0243655	Top slat iron assembly--left	-	-	-	-	-	-	-	-	-	1
0243658	Top slat iron to front cross bar bracket--right	-	-	-	-	-	-	-	-	-	1
0243659	Top slat iron to front cross bar bracket--left	-	-	-	-	-	-	-	-	-	1
6577	Screw 5/16-24 x 3/4 flat hd.	-	-	-	-	-	-	-	-	-	4
202917	Nut 5/16-24 blind	-	-	-	-	-	-	-	-	-	4
0243710	Top slat iron assembly to center slat iron shoulder bolt	-	-	-	-	-	-	-	-	2	-
241262	Top to windshield clamp catch--center	-	-	-	-	-	-	-	1	1	1
241263	Top to windshield clamp catch--side	-	-	-	-	-	-	-	2	2	2
6779	Screw No. 10-32 x 5/8 oval hd. (Phillips)	-	-	-	-	-	-	-	6	6	6
236916	Top to windshield header bumper	-	-	-	-	-	-	-	3	3	3
241106	Top to windshield header weatherstrip	-	-	-	-	-	-	-	1	1	1

TRUNK

235096	Trunk emblem	1	1	1	1	1	-	-	-	1	-
62065	Washer 1/4	1	1	1	1	1	-	-	-	1	-
5502	Lockwasher	1	1	1	1	1	-	-	-	1	-
239617	Nut 1/4-20	1	1	1	1	1	-	-	-	1	-
235961	Trunk emblem base	1	1	1	1	1	-	-	-	1	-
235108	Trunk emblem base gasket	1	1	1	1	1	-	-	-	1	-
241013	Trunk--lid assembly	1	1	1	1	1	-	-	-	1	-
312636	Trunk--lid brace assembly	1	1	1	1	1	-	-	-	1	-
312666	Trunk--lid brace screw	2	2	2	2	2	-	-	-	2	-
312667	Trunk--lid brace screw spring washer 13/32 diagonal	1	1	1	1	1	-	-	-	2	-
7304	Nut 1/4-20 plain	2	2	2	2	2	-	-	-	2	-
235165	Trunk--lid hinge assembly--left	-	-	-	-	1	-	-	-	-	-
235164	Trunk--lid hinge assembly--right	-	-	-	-	1	-	-	-	-	-
231537	Trunk--lid hinge assembly--left	1	1	1	1	-	-	-	-	1	-
231536	Trunk--lid hinge assembly--right	1	1	1	1	-	-	-	-	1	-
6650	Screw 1/4-20 x 1/2 hex. hd.	8	8	8	8	4	-	-	-	8	-
6735	Screw 1/4-20 x 5/8 hex. hd.	-	-	-	-	4	-	-	-	-	-
6751	Lockwasher 1/4 (Shakeproof)	8	8	8	8	8	-	-	-	8	-
312587	Trunk--lid hinge liner (body half)	2	2	2	2	2	-	-	-	2	-
312586	Trunk--lid hinge liner (lid half)	2	2	2	2	2	-	-	-	2	-

(17th Series)

Piece No.	Name	No. Required									
		1232 5 P. Formal Sedan	1233 5 P. Tour. Sedan	1234 7 P. Tour. Sedan	1235 7 P. Tour. Sedan Lim.	1236 5 P. Club Se-Jar.	1237 5 P. Coupe	1238 2-4 P. Coupe	1239 2-4 P. Conv. Coupe	1253 5 P. Conv. Sedan	1227 5 P. Victoria
314021	Trunk--lid lock assembly	1	1	1	1	1	-	-	-	1	-
5676	Screw No. 10-32 x 3/8 rnd. hd.	8	8	8	8	8	-	-	-	8	-
5868	Screw No. 10-32 x 5/8 flat hd.	2	2	2	2	2	-	-	-	2	-
5491	Lockwasher No. 10 countersunk (Shakeproof)	2	2	2	2	2	-	-	-	2	-
5935	Lockwasher 3/16 (Shakeproof)	8	8	8	8	8	-	-	-	8	-
245201	Trunk--lid lock handle (With key lock)	1	1	1	1	1	-	-	-	1	-
326046	Trunk--lid lock handle gasket	1	1	1	1	1	-	-	-	1	-
5676	Trunk--lid lock handle screw No. 10-32 x 3/8 rnd. hd.	1	1	1	1	1	-	-	-	1	-
6587	Lockwasher No. 10 (Shakeproof)	1	1	1	1	1	-	-	-	1	-
337017	Trunk--lid lock handle--cylinder lock	1	1	1	1	1	-	-	-	1	-
0314920	Trunk--lid lock plunger assembly--right ...	1	1	1	1	1	-	-	-	1	-
0314921	Trunk--lid lock plunger assembly--left	1	1	1	1	1	-	-	-	1	-
0314922	Trunk--lid lock rack--right	1	1	1	1	1	-	-	-	1	-
0314923	Trunk--lid lock rack--left	1	1	1	1	1	-	-	-	1	-
235306	Trunk--lid lock striker--right	1	1	1	1	-	-	-	-	1	-
235304	Trunk--lid lock striker--right	-	-	-	-	1	-	-	-	-	-
235307	Trunk--lid lock striker--left	1	1	1	1	-	-	-	-	1	-
235305	Trunk--lid lock striker--left	-	-	-	-	1	-	-	-	-	-
235420	Trunk--lid weatherstrip	1	1	1	1	1	-	-	-	1	-

VANITY CASE

245025	Vanity cabinet--right	1	-	-	-	-	-	-	-	-	-
245024	Vanity cabinet--left	1	-	-	-	-	-	-	-	-	-
4994	Screw No. 12 x 1 oval hd.	4	-	-	-	-	-	-	-	-	-
235176	Vanity cabinet bottle	2	-	-	-	-	-	-	-	-	-
235177	Vanity cabinet memorandum book	2	-	-	-	-	-	-	-	-	-
184433	Vanity cabinet memorandum book pencil	2	-	-	-	-	-	-	-	-	-
224262	Vanity case memorandum book	-	1	1	1	1	1	-	-	1	1
180082	Vanity case memorandum book pencil	-	1	1	1	1	1	-	-	1	1
224263	Vanity case mirror	-	-	-	-	-	-	-	-	1	1
224629	Vanity case mirror	-	1	1	1	1	1	-	-	-	-

VENTILATOR

235690	Ventilator cover assembly	1	1	1	1	1	1	1	1	1	1
5198	Ventilator cover attaching screw No. 10-32 x 5/8 hex. hd.	3	3	3	3	3	3	3	3	3	3
6653	Washer 3/16	3	3	3	3	3	3	3	3	3	3
6056	Lockwasher 3/16 Shakeproof	3	3	3	3	3	3	3	3	3	3
7003	Nut No. 10-32	3	3	3	3	3	3	3	3	3	3
235704	Ventilator cover adjusting link--lower	1	1	1	1	1	1	1	1	1	1
235696	Ventilator cover adjusting link--upper	1	1	1	1	1	1	1	1	1	1
310145	Ventilator cover adjusting link rivet	1	1	1	1	1	1	1	1	1	1
314537	Ventilator cover adjusting link rivet spring washer	1	1	1	1	1	1	1	1	1	1
5198	Ventilator cover adjusting link screw No. 10-32 x 5/8 hex. hd.	1	1	1	1	1	1	1	1	1	1
3867	Washer No. 10 plain	2	2	2	2	2	2	2	2	2	2
5500	Lockwasher No. 10	1	1	1	1	1	1	1	1	1	1
7003	Nut No. 10-32	1	1	1	1	1	1	1	1	1	1

(17th Series)

Piece No.	Name	No. Required									
		1232 5 P. Formal Sedan	1233 5 P. Tour. Sedan	1234 7 P. Tour. Sedan	1235 7 P. Tour. Sedan Lim.	1236 5 P. Club Sedan	1237 5 P. Coupe	1238 2-4 P. Coupe	1239 2-4 P. Conv. Coupe	1253 5 P. Conv. Sedan	1237 5 P. Victoria
235872	Ventilator cover adjusting link to hinge										
	screw	1	1	1	1	1	1	1	1	1	1
5502	Lockwasher 1/4	1	1	1	1	1	1	1	1	1	1
7004	Nut 1/4-28	1	1	1	1	1	1	1	1	1	1
235720	Ventilator cover moulding	1	1	1	1	1	1	1	1	1	1
6471	Screw No. 6-32 x 1/4 round hd.	2	2	2	2	2	2	2	2	2	2
318999	Ventilator cover moulding rubber washer ...	2	2	2	2	2	2	2	2	2	2
3867	Washer 3/16	2	2	2	2	2	2	2	2	2	2
235702	Ventilator to dash panel brace	1	1	1	1	1	1	1	1	1	1
4153	Rivet 3/16 x 7/16 round hd.	4	4	4	4	4	4	4	4	4	4
235830	Ventilator drain tube hose	1	1	1	1	1	1	1	1	1	1
235691	Ventilator handle	1	1	1	1	1	1	1	1	1	1
5079	Ventilator handle ball	1	1	1	1	1	1	1	1	1	1
310139	Ventilator handle ball and spring retainer.	1	1	1	1	1	1	1	1	1	1
310144	Ventilator handle ball and spring retainer										
	rivet	1	1	1	1	1	1	1	1	1	1
310146	Ventilator handle ball spring	1	1	1	1	1	1	1	1	1	1
337057	Ventilator handle knob	1	1	1	1	1	1	1	1	1	1
245243	Ventilator handle support and link assembly	1	1	1	1	1	1	1	1	1	1
6562	Screw 1/4-28 x 3/8 round hd.	2	2	2	2	2	2	2	2	2	2
5502	Lockwasher 1/4	2	2	2	2	2	2	2	2	2	2
235757	Ventilator weatherstrip	1	1	1	1	1	1	1	1	1	1

WHEEL COMPARTMENT

241014	Wheel compartment door assembly	-	-	-	-	-	1	-	-	-	1
224973	Wheel compartment door brace assembly--left	-	-	-	-	-	1	-	-	-	1
228121	Wheel compartment door brace assembly--right	-	-	-	-	-	1	-	-	-	1
5747	Screw 1/4-28 x 1-5/8 flat hd.	-	-	-	-	-	2	-	-	-	2
5676	Screw No. 10-32 x 3/8 round hd.	-	-	-	-	-	2	-	-	-	2
62065	Washer 1/4 plain special	-	-	-	-	-	2	-	-	-	2
5500	Lockwasher 3/16	-	-	-	-	-	2	-	-	-	2
7003	Nut No. 10-32	-	-	-	-	-	2	-	-	-	2
5502	Lockwasher 1/4	-	-	-	-	-	2	-	-	-	2
7004	Nut 1/4-28	-	-	-	-	-	2	-	-	-	2
111687	Wheel compartment door bumper	-	-	-	-	-	2	-	-	-	2
224840	Wheel compartment door drain gutter assy. .	-	-	-	-	-	1	-	-	-	1
226065	Wheel compartment door hinge assembly--rt..	-	-	-	-	-	1	-	-	-	1
226066	Wheel compartment door hinge assembly--lt..	-	-	-	-	-	1	-	-	-	1
8221	Screw 1/4-28 x 1-5/16 flat hd.	-	-	-	-	-	8	-	-	-	8
220783	Wheel compartment door hinge screw 5/16-24										
	x 1-1/2 hex. hd.	-	-	-	-	-	2	-	-	-	2
5504	Lockwasher 5/16	-	-	-	-	-	2	-	-	-	2
176282	Wheel compartment door lock	-	-	-	-	-	1	-	-	-	1
245202	Wheel compartment door lock handle (With										
	key lock)	-	-	-	-	-	1	-	-	-	1
337017	Wheel compartment door lock handle										
	cylinder lock	-	-	-	-	-	1	-	-	-	1
235947	Wheel compartment door lock handle screw ..	-	-	-	-	-	1	-	-	-	-
185236	Wheel compartment door lock handle screw										
	washer	-	-	-	-	-	1	-	-	-	-
326046	Wheel compartment door lock handle gasket .	-	-	-	-	-	1	-	-	-	1
224910	Wheel compartment door lock striker	-	-	-	-	-	1	-	-	-	1
235975	Wheel compartment door panel	-	-	-	-	-	1	-	-	-	1

Piece No.	Name	(17th Series)									
		1232 5 P. Formal Sedan	1233 5 P. Tour. Sedan	1234 7 P. Tour. Sedan	1235 7 P. Tour. Sedan Lim.	1236 5 P. Club Sedan	1237 5 P. Coupe	1238 2-4 P. Coupe	1239 2-4 P. Conv. Coupe	1253 5 P. Conv. Sedan	1277 5 P. Victoria
		No. Required									
226269	Wheel compartment door weatherstrip--long .	-	-	-	-	-	1	-	-	-	1
226286	Wheel compartment door weatherstrip--short.	-	-	-	-	-	1	-	-	-	1
231937	Wheel compartment tire clamp	1	1	1	1	1	1	-	-	1	1
231938	Wheel compartment tire clamp bolt	1	1	1	1	1	1	-	-	1	1
235147	Wheel compartment tire clamp bolt bracket assembly	1	1	1	1	-	-	-	-	1	-
231989	Wheel compartment tire clamp bolt bracket assembly	-	-	-	-	1	1	-	-	-	1
7824	Screw 1/4-28 x 5/8 hex. hd.	4	4	4	4	4	4	-	-	4	4
5502	Lockwasher 1/4	4	4	4	4	4	4	-	-	4	4
7004	Nut 1/4-28	4	4	4	4	4	4	-	-	4	4
231986	Wheel compartment tire stop	2	2	2	2	2	2	-	-	2	2
7824	Screw 1/4-28 x 5/8 hex. hd.	4	4	4	4	4	4	-	-	4	4
5502	Lockwasher 1/4	4	4	4	4	4	4	-	-	4	4
62065	Washer 1/4	4	4	4	4	4	4	-	-	4	4

WINDSHIELD

235882	Windshield cleaner to dash connection tube assembly	1	1	1	1	1	1	1	1	1	1
241165	Windshield cleaner dash tube to vacuum regulator hose	1	1	1	1	1	1	1	1	1	1
235824	Windshield cleaner driver assembly--right .	1	1	1	1	1	1	1	1	1	1
235825	Windshield cleaner driver assembly--left ..	1	1	1	1	1	1	1	1	1	1
5873	Screw 1/4-28 x 9/16 hex. hd.	2	2	2	2	2	2	2	2	2	2
6751	Lockwasher 1/4 (Shakeproof)	2	2	2	2	2	2	2	2	2	2
235826	Windshield cleaner driver gasket	2	2	2	2	2	2	2	2	2	2
307165	Windshield cleaner driver shaft pivot felt washer	2	2	2	2	2	2	2	2	2	2
314286	Windshield cleaner driver shaft pivot retainer plate and spring assembly	1	1	1	1	1	1	1	1	1	1
235829	Windshield cleaner motor assembly	1	1	1	1	1	1	1	1	1	1
5739	Screw No. 10-32 x 1/2 hex. hd.	2	2	2	2	2	2	2	2	2	2
5818	Lockwasher No. 10 (Shakeproof)	2	2	2	2	2	2	2	2	2	2
235821	Windshield cleaner motor control assembly .	1	1	1	1	1	1	1	1	1	1
325931	Windshield cleaner motor control assy. gasket	1	1	1	1	1	1	1	1	1	1
235822	Windshield cleaner motor control assembly knob	1	1	1	1	1	1	1	1	1	1
235749	Windshield cleaner motor support bracket ..	1	1	1	1	1	1	1	1	1	1
241164	Windshield cleaner motor vacuum regulator to motor hose	1	1	1	1	1	1	1	1	1	1
210070	Windshield cleaner vacuum pump dash connection	1	1	1	1	1	1	1	1	1	1
7007	Nut 7/16-20	1	1	1	1	1	1	1	1	1	1
5806	Lockwasher 7/16 (Shakeproof)	1	1	1	1	1	1	1	1	1	1
3883	Plain washer 7/16	1	1	1	1	1	1	1	1	1	1
240504	Windshield cleaner vacuum pump to dash connection tube assembly	1	1	1	1	1	1	1	1	1	1
6399	Windshield cleaner vacuum pump to dash connection tube dash connection union nut 1/4 flared tube	1	1	1	1	1	1	1	1	1	1
6344	Nut 1/4 flared tube inverted weatherhead	1	1	1	1	1	1	1	1	1	1

Piece No.	Name	(17th Series)									
		1232 5 P. Formal Sedan	1233 5 P. Tour. Sedan	1234 7 P. Tour. Sedan	1235 7 P. Tour. Sedan Lim.	1236 5 P. Club Sedan	1237 5 P. Coupe	1238 2-4 P. Coupe	1239 2-4 P. Conv. Coupe	1243 5 P. Conv. Sedan	1227 5 P. Victoria
		No. Required									
6279	Elbow 1/4 flared tube inverted weatherhead	1	1	1	1	1	1	1	1	1	1
70128	Windshield cleaner vacuum pump to dash connection tube assembly clip (to dash)	1	1	1	1	1	1	1	1	1	1
7004	Nut 1/4-28	1	1	1	1	1	1	1	1	1	1
5502	Lockwasher 1/4	1	1	1	1	1	1	1	1	1	1
234975	Windshield cleaner vacuum pump to dash connection tube assembly clip (to oil gauge tube)	2	2	2	2	2	2	2	2	2	2
241162	Windshield cleaner vacuum regulator assy. .	1	1	1	1	1	1	1	1	1	1
6653	Washer 3/16	1	1	1	1	1	1	1	1	1	1
5500	Lockwasher 3/16	1	1	1	1	1	1	1	1	1	1
7903	Nut No. 10-32	1	1	1	1	1	1	1	1	1	1
241163	Windshield cleaner vacuum regulator bracket	1	1	1	1	1	1	1	1	1	1
8033	Screw No. 8-32 x 9/16 oval hd.	2	2	2	2	2	2	2	2	2	2
5695	Lockwasher No. 8	2	2	2	2	2	2	2	2	2	2
7002	Nut No. 8-32	2	2	2	2	2	2	2	2	2	2
211059	Windshield cleaner wiper	2	2	2	2	2	2	2	2	2	2
235828	Windshield cleaner wiper arm assembly	2	2	2	2	2	2	2	2	2	2
224668	Windshield cleaner wiper arm assembly nut .	2	2	2	2	2	2	2	2	2	2
235774	Windshield division channel assembly	1	1	1	1	1	1	1	-	-	-
236981	Windshield division channel assembly.....	-	-	-	-	-	-	-	1	1	1
235678	Windshield division channel end filler--upper	1	1	1	1	1	1	1	1	1	1
241038	Windshield division channel end filler--lower	1	1	1	1	1	1	1	1	1	1
245008	Windshield division finishing moulding--inside	1	1	1	1	1	1	1	-	-	-
245059	Windshield division finishing moulding--inside	-	-	-	-	-	-	-	1	1	1
6806	Screw No. 8-32 x 1-1/4 oval hd. (Phillips--header point)	4	4	4	4	4	4	4	4	4	4
199786	Windshield division finish moulding inside screw ferrule	4	4	4	4	4	4	4	4	4	4
235705	Windshield division finishing moulding--outside	-	1	1	1	1	1	1	-	-	-
243801	Windshield division finishing moulding--outside	1	-	-	-	-	-	-	-	-	-
236884	Windshield division finishing moulding--outside	-	-	-	-	-	-	-	1	1	1
235706	Windshield division finishing moulding outside retainer--center	1	1	1	1	1	1	1	-	-	-
235710	Windshield division finishing moulding outside retainer--lower	1	1	1	1	1	1	1	1	1	1
235711	Windshield division finishing moulding outside retainer--upper	1	1	1	1	1	1	1	-	-	-
236875	Windshield division finishing moulding outside retainer--upper	-	-	-	-	-	-	-	1	1	1
245009	Windshield finishing moulding assembly	1	1	1	1	1	1	1	-	-	-
245058	Windshield finishing moulding assembly	-	-	-	-	-	-	-	1	1	1
6792	Screw No. 6-40 x 1 oval hd. cone point	4	4	4	4	4	4	4	6	6	6
235771	Windshield finishing moulding assembly screw ferrule No. 6	10	10	10	10	10	10	10	10	10	10
235946	Windshield finishing moulding defroster hole grommet	2	2	2	2	2	2	2	2	2	2

Piece No.	(17th Series) Name	No. Required									
		1232 5 P. Formal Sedan	1233 5 P. Tour. Sedan	1234 7 P. Tour. Sedan	1235 7 P. Tour. Sedan Lim	1236 5 P. Club Sedan	1237 5 P. Coupe	1238 2-4 P. Coupe	1239 2-4 P. Conv. Coupe	1253 5 P. Conv. Sedan	1227 5 P. Victoria
235708	Windshield finishing rim—right	1	1	1	1	1	1	1	-	-	-
236882	Windshield finishing rim—right	-	-	-	-	-	-	-	1	1	1
235709	Windshield finishing rim—left	1	1	1	1	1	1	1	-	-	-
236883	Windshield finishing rim—left	-	-	-	-	-	-	-	1	1	1
235667	Windshield glass	2	2	2	2	2	2	2	-	-	-
236868	Windshield glass	-	-	-	-	-	-	-	2	2	2
235698	Windshield glass retainer—right	1	1	1	1	1	1	1	-	-	-
236970	Windshield glass retainer—right	-	-	-	-	-	-	-	1	1	1
235699	Windshield glass retainer—left	1	1	1	1	1	1	1	-	-	-
236971	Windshield glass retainer—left	-	-	-	-	-	-	-	1	1	1
220715	Windshield glass retainer screw No. 6 x 3/8 binding hd. (Parker Kalon) Type A	14	14	14	14	14	14	14	19	19	19
235751	Windshield glass weatherstrip—outer	1	1	1	1	1	1	1	-	-	-
236941	Windshield glass weatherstrip—outer	-	-	-	-	-	-	-	1	1	1
235860	Windshield glass weatherstrip—center	1	1	1	1	1	1	1	-	-	-
236866	Windshield glass weatherstrip—center	-	-	-	-	-	-	-	1	1	1
235611	Windshield header assembly	1	1	1	1	1	1	1	-	-	-
5684	Bolt 1/4-28 x 1-7/8 common carriage ..	2	-	-	-	-	-	-	-	-	-
7604	Bolt 1/4-28 x 1-5/8 common carriage ..	2	-	-	-	-	-	-	-	-	-
5502	Lockwasher 1/4	4	-	-	-	-	-	-	-	-	-
7004	Nut 1/4-28	4	-	-	-	-	-	-	-	-	-
8220	Screw 1/4-28 x 1-1/2 flat hd.	8	8	8	8	8	8	8	-	-	-
8234	Screw 1/4-28 x 1-3/4 flat hd.	2	2	2	2	2	2	2	-	-	-
224887	Washer countersunk (Shakeproof)	10	10	10	10	10	10	10	-	-	-
199045	Windshield header sun visor clinch nut	4	4	4	4	4	4	4	-	-	-
235969	Windshield header trim stick	2	2	2	2	2	2	2	-	-	-
6327	Rivet 9/64 x 3/8 oval hd. tubular	14	14	14	14	14	14	14	-	-	-

TRIMMING

To avoid errors due to difference in texture and shade, please furnish sample when ordering trimming material.

233264	Assembly-button fabric covered upholsterer clincher	x	x	x	x	x	x	x	-	-	-
233109	Assembly-button fabric covered upholsterer tufting	x	x	x	x	x	x	x	-	-	-
233596	Assembly-button leather covered upholsterer	-	-	-	x	-	-	-	x	x	x
233126	Assembly-button leather covered upholsterer clincher	-	-	-	x	-	-	-	x	x	x
244179	Assembly-carpet floor front	-	-	-	-	-	-	-	-	1	-
244176	Assembly-carpet floor front (With partition for 1233)	1	1	-	1	-	-	-	-	-	-
244177	Assembly-carpet floor front	-	-	-	-	-	-	1	-	-	-
244178	Assembly-carpet floor front	-	1	1	-	1	-	-	-	-	1
244181	Assembly-carpet floor front	-	-	-	-	-	-	-	1	-	-
244182	Assembly-carpet floor front	-	-	-	-	-	1	-	-	-	-
244092	Assembly-carpet floor rear	-	-	1	-	-	-	-	-	-	-
244094	Assembly-carpet floor rear	-	-	-	1	-	-	-	-	-	-
244097	Assembly-carpet floor rear	-	1	-	-	-	-	-	-	-	-
244098	Assembly-carpet floor rear (With partition for 1233)	1	1	-	-	-	-	-	-	-	-
244099	Assembly-carpet floor rear	-	-	-	-	1	-	-	-	-	-

Piece No.	Name	(17th Series)										No. Required
		1232 5 P. Formal Sedan	1233 5 P. Tour. Sedan	1234 7 P. Tour. Sedan	1235 7 P. Tour. Sedan Lim.	1236 5 P. Club Sedan	1237 5 P. Coupe	1238 2-4 P. Coupe	1239 2-4 P. Conv. Coupe	1283 5 P. Conv. Sedan	1277 5 P. Victoria	
244100	Assembly-carpet floor rear	-	-	-	-	-	1	-	-	-	-	
244093	Assembly-carpet floor rear	-	-	-	-	-	-	-	-	-	1	
236780	Assembly-carpet floor rear	-	-	-	-	-	-	-	-	1	-	
244103	Assembly-carpet folding seat floor (Mohair)	-	-	2	-	-	-	-	-	-	-	
244104	Assembly-carpet folding seat floor (Mohair)	-	-	-	2	-	-	-	-	-	-	
226432	Assembly-carpet floor rear compartment	-	-	-	-	-	1	-	-	-	-	
233619	Assembly-carpet rear compartment floor pad (Use with side wheel carrier)	-	-	-	-	-	1	-	-	-	-	
229705	Assembly-carpet rumble seat compartment floor	-	-	-	-	-	-	-	1	-	-	
226437	Assembly-carpet rumble seat compartment floor	-	-	-	-	-	-	1	-	-	-	
317235	Assembly-carpet trunk compartment floor	-	-	-	-	1	-	-	-	-	-	
233514	Assembly-carpet trunk compartment floor (Use with side wheel carrier)	1	1	1	1	-	-	-	-	-	-	
317234	Assembly-carpet trunk compartment floor ...	1	1	1	1	-	-	-	-	-	-	
233515	Assembly-carpet trunk compartment floor (Use with side wheel carrier)	-	-	-	-	1	-	-	-	-	-	
244018	Assembly-carpet trunk compartment floor (Side wheel carrier)	-	-	-	-	-	-	-	-	1	-	
244020	Assembly-carpet trunk compartment floor pan (Side wheel carrier)	-	-	-	-	-	-	-	-	1	-	
244001	Assembly-carpet trunk compartment shelf (Rear carrier)	-	-	-	-	-	-	-	-	1	-	
233017	Assembly-door trimming front--left	-	-	-	-	-	1	1	-	-	-	
233011	Assembly-door trimming front--left	1	1	1	-	-	-	-	-	-	-	
233018	Assembly-door trimming front--left	-	-	-	-	-	-	-	1	-	-	
233013	Assembly-door trimming front--left	-	-	-	-	1	-	-	-	-	-	
233015	Assembly-door trimming front--left	-	-	-	1	-	-	-	-	-	-	
233016	Assembly-door trimming front--right	-	-	-	-	-	1	1	-	-	-	
233019	Assembly-door trimming front--right	-	-	-	-	-	-	-	1	-	-	
233010	Assembly-door trimming front--right	1	1	1	-	-	-	-	-	-	-	
233012	Assembly-door trimming front--right	-	1	-	-	1	-	-	-	-	-	
233014	Assembly-door trimming front--right	-	-	-	1	-	-	-	-	-	-	
243052	Assembly-door trimming front--right	-	-	-	-	-	-	-	-	-	1	
243053	Assembly-door trimming front--left	-	-	-	-	-	-	-	-	-	1	
243140	Assembly-door trimming front--right	-	-	-	-	-	-	-	-	1	-	
243141	Assembly-door trimming front--left	-	-	-	-	-	-	-	-	1	-	
233021	Assembly-door trimming rear--left	1	1	-	-	-	-	-	-	-	-	
233023	Assembly-door trimming rear--left	-	-	1	1	1	-	-	-	-	-	
233020	Assembly-door trimming rear--right	1	1	-	-	-	-	-	-	-	-	
233022	Assembly-door trimming rear--right	-	-	1	1	1	-	-	-	-	-	
243142	Assembly-door trimming rear--right	-	-	-	-	-	-	-	-	1	-	
243143	Assembly-door trimming rear--left	-	-	-	-	-	-	-	-	1	-	
229715	Assembly-golf compartment door trimming ...	-	-	-	-	-	-	-	2	-	-	
229569	Assembly-golf compartment door trimming ...	-	-	-	-	-	-	2	-	-	-	
233760	Assembly headlining (Specify set number) ..	1	-	-	-	-	-	-	-	-	-	
233762	Assembly headlining (Specify set number) ..	-	1	-	-	-	-	-	-	-	-	
233763	Assembly-headlining (Specify set number) ..	-	-	1	-	-	-	-	-	-	-	
233764	Assembly-headlining (Specify set number) ..	-	-	-	-	1	-	-	-	-	-	
233765	Assembly-headlining (Specify set number) ..	-	-	-	-	-	1	-	-	-	-	
233766	Assembly-headlining (Specify set number) ..	-	-	-	-	-	-	1	-	-	-	
233767	Assembly-headlining front compartment (Specify set number).....	-	-	-	1	-	-	-	-	-	-	

Piece No.	(17th Series) Name	No. Required									
		1232 5 P. Formal Sedan	1233 5 P. Tour. Sedan	1234 7 P. Tour. Sedan	1235 7 P. Tour. Sedan Lim.	1236 5 P. Club Sedan	1237 5 P. Coupe	1238 2-4 P. Coupe	1239 2-4 P. Conv. Coupe	1253 5 P. Conv. Sedan	1227 5 P. Victoria
233768	Assembly--headlining rear compartment (Specify set number)	-	-	-	1	-	-	-	-	-	-
226425	Assembly--pad folding seat compartment floor	-	-	2	2	-	-	-	-	-	-
233353	Binding cloth wire-on (Pattern Vogt No. 936) (Specify set number)	x	x	x	x	x	-	x	-	-	-
228405	Binding cloth wire-on (Top Fabric) (Specify set number)	-	-	-	-	-	-	-	x	x	x
233354	Binding cloth wire-on (Cordless 1/2" wide) (Pattern Vogt No. 936) (Specify set number)	x	x	x	x	x	x	x	-	-	-
156596	Binding lace 7/16" (Specify set number) ...	-	x	x	x	x	x	-	-	-	-
127259	Binding carpet (Specify set number)	x	x	x	x	x	x	x	x	x	x
306536	Binding 1-1/8" bias cut--black imitation (Specify set number)	x	x	x	x	x	x	x	-	-	-
228406	Binding 3/4" Gimp--top fabric (Specify set number)	-	-	-	-	-	-	-	x	x	x
306251	Binding--imitation leather wire-on (Colonial Grain 5/8" wide) (Specify set number)	-	-	-	-	-	-	-	x	x	x
176578	Binding leather wire-on Colonial Grain (Specify set number)	-	-	-	x	-	-	x	x	x	x
206731	Binding rattan 3/8" half round (Specify set number)	-	x	x	x	-	-	-	-	-	-
177812	Binding tip-wire-on top--left	-	-	-	-	-	-	-	x	x	x
177813	Binding tip-wire-on top--right	-	-	-	-	-	-	-	x	x	x
233356	Binding weatherstrip (Pattern Vogt No. 936). (Specify set number)	x	x	x	x	x	x	x	-	-	-
5579	Brad No. 19 x 3/4 (Taper head)	x	x	x	x	x	x	x	-	-	-
5738	Brad No. 19 x 1/2 (Taper head)	x	x	x	x	x	x	x	-	-	-
167914	Buckram 38" wide--single ply Cotton back ..	-	-	-	x	x	-	-	-	-	x
312372	Button hold down tape (5-1/2" long) (White)	-	-	-	-	-	-	x	x	x	x
312373	Button hold down tape (6" long) (Yellow)	x	x	x	x	x	x	-	x	x	x
312374	Button hold down tape (8-3/4" long) (Purple)	-	x	x	-	x	x	-	-	x	x
233205	Button hold down tape (6-3/4" long) (Green)	x	x	x	x	-	-	x	x	x	x
233026	Button hold down tape (7-1/4" long) (Tan) .	x	-	-	x	-	x	x	-	x	x
113980	Carpet woolen 36" wide	x	x	x	x	x	-	-	-	x	x
200996	Carpet rubber set 36" wide	-	-	-	-	-	-	x	x	-	x
29651	Cloth cotton 36" wide	x	x	x	x	x	x	x	-	x	x
233267	Cloth cotton oiled 50" wide	x	x	x	x	x	x	x	-	-	-
29790	Cord window curtain guide	-	x	x	x	-	x	-	-	-	-
113822	Cord welt enameled drill	-	x	x	-	x	-	-	-	-	-
156696	Cord welt 9/16 x 3/16 leather natural grain	-	-	-	x	-	-	x	x	x	x
233352	Cord welt seaming lace 11/16 paper cord 1/2" flange (Pattern Vogt No. 936)	x	x	x	x	x	x	x	-	-	-
243470	Cord welt 5/8 x 3/16 imitation leather paper cord 5/8" flange	-	-	-	-	-	-	-	x	x	x
243021	Cord welt 5/8 x 3/16 imitation leather (Walnut finish)	x	x	x	x	x	x	x	x	x	x
243410	Cord welt--top material covered 3/16 paper cord 5/8" flange	-	-	-	-	-	-	-	x	x	x
169249	Drill sized plain 33" wide	-	x	-	-	x	-	-	-	-	-
161787	Drill white cotton 7 oz. 36" wide	x	x	x	x	x	x	x	x	x	x
306132	Fabric Osnaburg 50" wide	x	x	x	x	x	x	x	x	x	x

Piece No.	Name	(17th Series)									
		1232 5 P. Formal Sedan	1833 5 P. Tour. Sedan	1234 7 P. Tour. Sedan	1235 7 P. Tour. Sedan Lim.	1236 5 P. Club Sedan	1237 5 P. Coupe	1238 2-4 P. Coupe	1239 2-4 P. Conv. Coupe	1253 5 P. Conv. Sedan	1227 5 P. Victoria
		No. Required									
200467	Fabric top material (54" wide) water repellent treated (Khaki color)	-	-	-	-	-	-	-	X	X	X
334068	Fabric top material 54" wide (Black)	-	-	-	-	-	-	-	X	X	X
233853	Fabric upholstery	-	-	-	-	-	-	-	-	X	X
185211	Fabric 58" upholstery	X	X	X	X	X	X	X	-	-	-
184863	Fabric-roof covering 45" wide turtle grain (Black finish)	X	-	-	-	-	-	-	-	-	-
218169	Fabric-roof covering 45" wide Vox grain	X	X	X	X	X	X	X	-	-	-
218170	Fabric-roof covering 45" wide Vox grain ...	-	X	X	X	X	X	X	-	-	-
195664	Fastener eyelet-top envelope	-	-	-	-	-	-	-	-	X	X
229579	Fastener eyelet washer--rear seat back strap	-	-	-	-	-	-	-	-	-	X
161794	Fastener single wood screw post top envelope	-	-	-	-	-	-	-	-	X	X
227914	Fastener stud-top envelope	-	-	-	-	-	-	-	-	X	X
161792	Fastener washer-top envelope	-	-	-	-	-	-	-	-	X	X
229578	Fastener eyelet long-top rear curtain	-	-	-	-	-	-	-	X	X	X
229579	Fastener eyelet washer-top rear curtain ...	-	-	-	-	-	-	-	X	X	X
229577	Fastener stud wood screw-top rear curtain (long single)	-	-	-	-	-	-	-	X	-	-
233797	Felt-black 2-3/8" wide 1/8" thick	X	X	X	X	X	X	X	-	-	-
233799	Felt 3/16 x 1" (black) partition	-	-	-	-	-	-	-	-	X	-
195338	Felt top bow filler	-	-	-	-	-	-	-	X	X	X
156857	Gimp 3/4 bias cut imitation leather	X	X	X	X	X	X	X	X	-	-
228406	Gimp 3/4 fabric top material	-	-	-	-	-	-	-	X	X	X
156692	Gimp (1/2" imitation black Colonial leather	X	X	X	X	X	X	X	X	X	X
325447	Grommet No. 2 cushion screen	-	-	-	-	-	-	-	-	11	11
136832	Grommet No. 2 arm rest pocket	-	-	-	1	-	-	-	-	-	-
325448	Grommet washer-cushion screen	-	-	-	-	-	-	-	-	11	11
136832	Grommet No. 2 rumble seat back vent	-	-	-	-	-	-	5	5	-	-
136833	Grommet No. 2 washer arm rest pocket	-	-	-	1	-	-	-	-	-	-
136833	Grommet No. 2 washer-rumble seat back vent.	-	-	-	-	-	-	5	5	-	-
306188	Hog rings, Jenks and Muir or equivalent ...	X	X	X	-	X	X	-	-	-	-
314737	Hog ring (large)	X	X	X	X	X	X	X	X	X	X
214109	Leather imitation 52" wide Color Black	-	-	-	-	-	X	-	-	-	-
156348	Leather trimming (Colonial grain)	-	-	-	X	-	X	X	X	X	X
156346	Leather imitation (Colonial grain)	X	X	X	X	X	X	X	X	X	X
183986	Leather turtle grain landau 10 to 10-1/2 oz. (Black)	X	-	-	-	-	-	-	-	-	-
161778	Leather binding .020 thick	-	X	X	X	-	-	-	-	-	-
192303	Muslin rubber 54" wide	X	X	X	X	X	-	X	X	X	-
140935	Paperboard (1/2 x 48")	X	X	X	X	X	X	X	-	-	-
135117	Paperboard shim 1/16 x 1 x 36	X	X	X	X	X	X	X	-	-	-
182894	Papercord 1/4 twisted	X	X	X	X	X	X	X	X	-	-
211171	Plush high pile worsted	-	-	-	-	-	-	-	-	X	X
224304	Rubber strip-door weatherstrip	X	X	X	X	X	X	X	X	X	X
228320	Rubber riser 1/2 half round	X	X	X	X	X	X	X	X	X	X
113983	Silk curtain 22" wide	X	X	X	X	X	X	X	-	-	-
175757	Snap fastener eyelet-top envelope	-	-	-	-	-	-	-	X	X	X
175757	Snap fastener eyelet-top side quarter	-	-	-	-	-	-	-	X	-	-
115799	Snap fastener socket-carpet trunk compartment floor	X	X	X	X	-	-	-	-	-	-
137510	Snap fastener socket-cowl panel tab	X	X	X	X	X	X	X	-	X	X
115798	Snap fastener socket ring (short prong) carpet trunk compartment floor	X	X	X	X	-	-	-	-	-	-
200073	Snap fastener socket-rumble seat compartment floor carpet	-	-	-	-	-	-	X	X	-	-

Piece No.	Name	(17th Series)									
		1232 5 P. Formal Sedan	1233 5 P. Tour. Sedan	1234 7 P. Tour. Sedan	1235 7 P. Tour. Sedas Lim.	1236 5 P. Club Sedan	1237 5 P. Coupe	1238 2-4 P. Coupe	1239 2-4 P. Conv. Coupe	1253 5 P. Conv. Sedan	1227 5 P. Victoria
		No. Required									
139150	Snap fastener socket-top envelope	-	-	-	-	-	-	-	X	X	X
214974	Snap fastener socket-top side quarter	-	-	-	-	-	-	-	X	-	-
206744	Snap fastener stud (drive screw) carpet rear floor	X	X	X	X	X	X	-	-	X	X
185412	Snap fastener wood screw stud--rear curtain to rear bow	-	-	-	-	-	-	-	-	X	X
185412	Snap fastener wood screw stud--rear seat back strap	-	-	-	-	-	-	-	-	-	X
159060	Snap fastener stud (self tapping screw)--carpet rear floor	1	1	1	1	1	1	-	-	1	1
112058	Snap fastener stud (wood screw)	X	X	X	X	X	X	-	-	X	X
193201	Snap fastener stud (drive screw) carpet front floor	X	X	X	X	X	X	X	-	X	X
193201	Snap fastener stud (drive screw) carpet trunk compartment floor	X	X	X	X	-	-	-	-	-	-
185412	Snap fastener wood screw stud-top envelope.	-	-	-	-	-	-	-	X	X	X
206744	Snap fastener stud (drive screw) rumble seat compartment floor	-	-	-	-	-	-	X	X	-	-
139157	Snap fastener stud-top side quarter	-	-	-	-	-	-	-	X	-	-
175757	Snap fastener eyelet-carpet (Mohair) floor rear	X	X	X	X	X	X	-	-	X	X
139150	Snap fastener socket carpet (Mohair) floor rear	X	X	X	X	X	X	-	-	X	X
193200	Snap fastener stud (machine screw) carpet front floor	X	X	X	X	X	X	X	-	X	X
228144	Snap fastener stud (machine screw post) top	-	-	-	-	-	-	-	X	-	-
193199	Snap fastener stud (rivet) carpet front floor	X	X	X	X	X	X	X	-	-	-
206657	Tacks-upholsters (Specify set number)	X	X	X	X	-	X	-	-	-	-
29637	Thread No. EE Spool silk	X	X	X	X	X	X	X	X	X	X
192345	Thread No. 18 linen	X	X	X	X	X	X	X	X	X	X
192346	Thread No. 25 linen	X	X	X	X	X	X	X	X	X	X
29638	Thread "A" Spool silk	X	X	X	X	X	X	X	X	X	X
29640	Thread No. EE No. 18 or Dean and Sheck No. 12-4	X	X	X	X	X	X	X	X	X	X
127808	Thread-Dean and Sheck No. 20-A silk finish.	X	X	X	X	X	X	X	X	X	X
244175	Thread No. 90-3 Silk finish	X	X	X	X	X	X	X	-	-	-
157022	Thread-Lincoln No. 6	X	X	X	X	X	X	X	X	X	X
157586	Thread No. 1201 cord	X	X	X	X	X	X	X	X	X	X
29625	Twine No. 252 Yazoo	X	X	X	X	X	X	X	X	X	X
29627	Wadding 32" blue sheet No. 532	X	X	X	X	X	X	X	X	X	X
182687	Wadding 32" white unbleached No. 532	X	X	X	X	X	X	X	-	-	-
214213	Wadding 8" white cotton rolled	-	-	-	-	-	-	X	X	-	-
172470	Wadding 4" white cotton unbleached rolled .	X	X	X	X	X	X	X	X	X	X
128040	Wadding 32" white sheet	X	X	X	X	X	X	X	X	X	X
183741	Wadding roof 41" wide	X	X	X	X	X	X	X	-	-	-
193352	Webbing-elastic (1-1/2" wide)	-	-	-	-	-	-	X	X	X	-
233472	Webbing-elastic (1/2" wide) (Black)	-	X	X	-	X	-	-	-	-	-
62759	Webbing jute (3" wide)	-	-	X	X	-	-	-	X	X	X
233355	Windlace cloth (Pattern Vogt No. 936) (Specify set number)	X	X	X	X	X	X	X	-	-	-
339141	Windlace leather (Colonial grain)	-	-	-	-	-	-	-	X	X	X
226161	Wire No. 13 W. and M. Ga. (.0915)	-	X	X	X	-	X	-	-	-	-
233299	Wire No. 9 (.148)	-	X	X	-	X	-	-	-	-	-
229576	Zipper 12" long	-	-	-	-	-	-	-	2	-	-
328074	Zipper 13-3/4" long	-	-	-	-	-	-	-	2	2	2